



***Lattice*CORE™**

PCI IP User's Guide

Chapter 1. Introduction	6
Quick Facts	6
Features	10
Chapter 2. Functional Description	11
Block Diagram	11
PCI Master Control	11
PCI Target Control	12
Local Master Interface Control	12
Local Target Control	13
Configuration Space	13
Parity Generator and Checker	13
Signal Descriptions	13
PCI Interface Signals	14
Local Interface Signals	15
PCI Configuration Space Setup	18
Status Register	21
Base Address Registers	22
BAR Mapped to Memory Space	22
Bar Mapped to I/O Space	23
Cache Line Size	23
Latency Timer	23
CardBus CIS Pointer	23
Subsystem Vendor ID	23
Subsystem ID	23
Capabilities Pointer	24
Min_Gnt	24
Max_Lat	24
Interrupt Line	24
Interrupt Pin	24
Reserved	24
Lattice PCI IP core Configuration Options	24
IPexpress User-Controlled Configurations	24
PCI Configuration Using Core Configuration Space Port	25
Local Bus Interface	30
Target Operation	30
Master Operation	30
Basic PCI Master Read and Write Transactions	31
32-bit PCI Master with a 32-bit Local Bus	31
64-Bit PCI Master with a 64-Bit Local Bus	35
32-bit PCI Master with a 64-Bit Local Bus	40
Configuration Read and Write Transactions	46
PCI Master I/O Read and Write Transactions	46
Advanced Master Transactions	46
Wait States	46
Burst Read and Write Master Transactions	51
Dual Address Cycle (DAC)	70
Fast Back-to-Back Transactions	76
Master and Target Termination	81
Basic PCI Target Read and Write Transactions	81

32-bit PCI Target with a 32-bit Local Bus Memory Transactions	82
64-Bit PCI Target with a 64-Bit Local Bus	87
32-Bit PCI Target with a 64-Bit Local Bus	90
Configuration Read and Write Transactions	94
PCI Target I/O Read and Write Transactions	96
Advanced Target Transactions	97
Wait States	97
Burst Read and Write Target Transactions	100
Dual Address Cycle (DAC)	115
Fast Back-to-Back Transactions	117
Advanced Configuration Accesses	120
Target Termination	123
Disconnect With Data	124
Disconnect Without Data	127
Retry	130
Target Abort	133
Chapter 3. Parameter Settings	136
Bus Tab	137
Bus Definition	137
Backend Configuration	138
Synthesis/Simulation Tools Selection	138
Identification Tab	139
Vendor ID [15:0]	139
Device ID [15:0]	139
Subsystem Vendor ID [15:0]	139
Subsystem ID [15:0]	139
Revision ID [15:0]	139
Class Code (Base Class, Bus Class, Interface)	139
Options Tab	140
Devsel Timing	140
Expansion ROM BAR	140
Interrupts	141
PCI Master Tab (PCI Master/Target Cores Only)	141
Read Only Latency Timer	141
MIN_GNT	141
MAX_LAT	141
BARs Tab	141
Base Address Registers	142
BAR Configuration Options	142
BAR Width	142
BAR Type	142
Address Space Size	142
Prefetching Enable	142
Chapter 4. IP Core Generation	143
Licensing the IP Core	143
Getting Started	143
IPexpress-Created Files and Top Level Directory Structure	146
Instantiating the Core	147
Running Functional Simulation	147
Synthesizing and Implementing the Core in a Top-Level Design	148
Hardware Evaluation	148
Enabling Hardware Evaluation in Diamond	148
Enabling Hardware Evaluation in ispLEVER	149
Updating/Regenerating the IP Core	149

Regenerating an IP Core in Diamond	149
Regenerating an IP Core in ispLEVER	149
Chapter 5. Support Resources	151
Lattice Technical Support.....	151
Online Forums.....	151
Telephone Support Hotline	151
E-mail Support	151
Local Support.....	151
Internet.....	151
PCI-SIG Website.....	151
References.....	151
LatticeEC/ECP	151
LatticeECP2M	151
LatticeECP3	152
LatticeSC/M.....	152
LatticeXP	152
LatticeXP2.....	152
MachXO	152
MachXO2	152
Revision History	152
Appendix A. Resource Utilization	153
LatticeECP and LatticeEC FPGAs	153
Ordering Part Number.....	153
LatticeECP2 FPGAs.....	154
Ordering Part Number.....	154
LatticeECP2M FPGAs.....	155
Ordering Part Number.....	155
LatticeECP3 FPGAs.....	156
Ordering Part Number.....	156
LatticeXP FPGAs	157
Ordering Part Number.....	157
LatticeXP2 FPGAs	158
Ordering Part Number.....	158
MachXO FPGAs.....	159
Ordering Part Number.....	159
MachXO2 FPGAs.....	159
Ordering Part Number.....	159
LatticeSC FPGAs.....	160
Ordering Part Number.....	160
Appendix B. Pin Assignments For Lattice FPGAs	161
Pin Assignment Considerations for LatticeECP and LatticeEC Devices.....	161
PCI Pin Assignments for Master/Target 33MHz 64-Bit Bus	161
PCI Pin Assignments for Target 66MHz 64-Bit Bus.....	163
PCI Pin Assignments for Master/Target 33MHz 32-Bit Bus	165
PCI Pin Assignments for Target 33MHz 32-Bit Bus.....	167
Pin Assignment Considerations for LatticeXP Devices.....	168
PCI Pin Assignments for Master/Target 33MHz 32-Bit Bus	168
PCI Pin Assignments for Target 33MHz 32-Bit Bus.....	169
PCI Pin Assignments for Master/Target 33MHz 64-Bit Bus	171
Pin Assignment Considerations for MachXO Devices	173
PCI Pin Assignments for Target 33MHz 32-Bit Bus.....	173
PCI Pin Assignments for Target 66MHz 32-Bit Bus.....	175
PCI Pin Assignments for Master/Target 33MHz 32-Bit Bus	176

PCI Assignment Considerations for LatticeSC Devices	178
PCI Pin Assignments for Master/Target 33 MHz 32-bit Bus	178
PCI Pin Assignments for Master/Target 33 MHz 64-bit Bus	179
PCI Pin Assignments for Target 33 MHz 32-bit Bus	182
PCI Pin Assignments for Target 33 MHz 64-bit Bus	183
PCI Pin Assignments for Master/Target 66 MHz 32-bit Bus	185
PCI Pin Assignments for Master/Target 66 MHz 64-bit Bus	187
PCI Pin Assignments for Target 66 MHz 32-bit Bus	189
PCI Pin Assignments for Target 66 MHz 64-bit Bus	191

Lattice’s Peripheral Component Interconnect (PCI) Intellectual Property (IP) cores provide an ideal solution that meets the needs of today’s high performance PCI applications. The PCI IP cores provide a customizable, 32-bit or 64-bit PCI Master and Target or Target only solution that is fully compliant with the *PCI Local Bus Specification, Revision 3.0* for speeds up to 66MHz. The PCI cores bridge the gap between the PCI Bus and specific design applications, providing an integrated PCI solution. These cores allow designers to focus on the application rather than on the PCI specification, resulting in a faster time-to-market.

PCI is a widely accepted bus standard that is used in many applications including telecommunications, embedded systems, high performance peripheral cards, and networking. The family of PCI IP core is one of the many in Lattice’s portfolio of IP cores. For more information on these and other products, refer to the Lattice web site at: <http://www.latticesemi.com/products/intellectualproperty/>.

This document covers Target only, Master and Target, 64-bit, and 32-bit PCI IP cores implemented in a number of devices. Details of Master and 64-bit operation only apply to the appropriate cores. Pin assignments for specific variations of this core are described at the end of this document.

Quick Facts

Table 1-1 through Table 1-8 give quick facts about the PCI IP core for LatticeEC™, LatticeECP™, LatticeECP2™, LatticeECP2M™, LatticeECP3™, LatticeXP™, LatticeXP2™, LatticeSC™, MachXO™, MachXO2™, and LatticeSCM™ devices.

Table 1-1. PCI IP Core Quick Facts--PCI master/target 66MHz/64bit

		PCI IP configuration					
		PCI master/target 66MHz 64bit					
Core Requirements	FPGA Families Supported	LatticeEC LatticeECP	Lattice ECP2 Lattice ECP2M	LatticeXP	LatticeXP2	LatticeECP3	LatticeSC LatticeSCM
	Minimal Device Needed	LFEC10E-5F484C	LFE2-12E-6F484C	LFXP15C-5F388C	LFXP2-17E-6F484C	LFE3-35EA-7FN484CES	LFSC3GA15E-6F900C
Resource Utilization	Data Path Width	64					
	LUTs	2500					
	Registers	900					
Design Tool Support	Lattice Implementation	Lattice Diamond™ 1.0 or ispLEVER® 8.1					
	Synthesis	Synopsys® Synplify™ Pro for Lattice D-2009.12L-1					
		Mentor Graphics® Precision™ RTL					
	Simulation	Aldec® Active-HDL™ 8.2 Lattice Edition					
Mentor Graphics ModelSim™ SE 6.3F							

Table 1-2. PCI IP Core Quick Facts--PCI master/target 66MHz/32bit

		PCI IP configuration					
		PCI master/target 66MHz 32bit					
Core Requirements	FPGA Families Supported	LatticeEC LatticeECP	Lattice ECP2 Lattice ECP2M	LatticeXP	LatticeXP2	LatticeXP3	LatticeSC LatticeSCM
	Minimal Device Needed	LFEC6E- 5F256C	LFE2-6E- 6F256C	LFXP6C- 5F256C	LFXP2-5E- 6FT256C	LFE3-17EA- 7FN484CES	LFSC3GA15E- 6F900C
Resource Utilization	Data Path Width	32					
	LUTs	1600					
	Registers	700					
Design Tool Support	Lattice Implementation	Diamond 1.0 or ispLEVER 8.1					
	Synthesis	Synopsys Synplify Pro for Lattice D-2009.12L-1					
		Mentor Graphics Precision RTL					
	Simulation	Aldec Active-HDL 8.2 Lattice Edition					
Mentor Graphics ModelSim SE 6.3F							

Table 1-3. PCI IP Core Quick Facts--PCI master/target 33MHz/64bit

		PCI IP configuration					
		PCI master/target 33MHz 64bit					
Core Requirements	FPGA Families Supported	LatticeEC LatticeECP	Lattice ECP2 Lattice ECP2M	LatticeXP	LatticeXP2	LatticeXP3	LatticeSC LatticeSCM
	Minimal Device Needed	LFEC10E- 5F484C	LFE2-12E- 6F484C	LFXP15C- 5F388C	LFXP2-17E- 6F484C	LFE3-35EA- 7FN484CES	LFSC3GA15 E-6F900C
Resource Utilization	Data Path Width	64					
	LUTs	1400					
	Registers	800					
Design Tool Support	Lattice Implementation	Diamond 1.0 or ispLEVER 8.1					
	Synthesis	Synopsys Synplify Pro for Lattice D-2009.12L-1					
		Mentor Graphics Precision RTL					
	Simulation	Aldec Active-HDL 8.2 Lattice Edition					
Mentor Graphics ModelSim SE 6.3F							

Table 1-4. PCI IP Core Quick Facts--PCI master/target 33MHz/32bit

		PCI IP configuration							
		PCI master/target 33MHz 32bit							
Core Requirements	FPGA Families Supported	MachXO	MachXO2	LatticeEC LatticeECP	Lattice ECP2 Lattice ECP2M	LatticeXP	LatticeXP2	LatticeXP3	LatticeSC LatticeSCM
	Minimal Device Needed	LCMXO1200 E-5FT256C	LCMXO- 1200HC- 6TG144CES	LFEC6E- 5F256C	LFE2-6E- 6F256C	LFXP6C- 5F256C	LFXP2- 5E- 6FT256C	LFE3-17EA- 7FN484CES	LFSC3GA1 5E-6F900C
Resource Utilization	Data Path Width	32							
	LUTs	900							
	Registers	600							
Design Tool Support	Lattice Implementation	Diamond 1.0 or ispLEVER 8.1							
	Synthesis	Synopsys Synplify Pro for Lattice D-2009.12L-1							
		Mentor Graphics Precision RTL							
	Simulation	Aldec Active-HDL 8.2 Lattice Edition							
Mentor Graphics ModelSim SE 6.3F									

Table 1-5. PCI IP Core Quick Facts--PCI target 66MHz/64bit

		PCI IP configuration					
		PCI target 66MHz 64bit					
Core Requirements	FPGA Families Supported	LatticeEC LatticeECP	Lattice ECP2 Lattice ECP2M	LatticeXP	LatticeXP2	LatticeXP3	LatticeSC LatticeSCM
	Minimal Device Needed	LFEC6E- 5F484C	LFE2-12E- 6F484C	LFXP10C- 5F388C	LFXP2-8E- 6FT256C	LFE3-17EA- 7FN484CES	LFSC3GA15 E-6F900C
Resource Utilization	Data Path Width	64					
	LUTs	1300					
	Registers	600					
Design Tool Support	Lattice Implementation	Diamond 1.0 or ispLEVER 8.1					
	Synthesis	Synopsys Synplify Pro for Lattice D-2009.12L-1					
		Mentor Graphics Precision RTL					
	Simulation	Aldec Active-HDL 8.2 Lattice Edition					
Mentor Graphics ModelSim SE 6.3F							

Table 1-6. PCI IP Core Quick Facts--PCI target 66MHz/32bit

		PCI IP configuration					
		PCI target 66MHz 32bit					
Core Requirements	FPGA Families Supported	LatticeEC LatticeECP	Lattice ECP2 Lattice ECP2M	LatticeXP	LatticeXP2	LatticeXP3	LatticeSC LatticeSCM
	Minimal Device Needed	LFEC3E- 5Q208C	LFE2-6E- 6F256C	LFXP3C- 5Q208C	LFXP2-5E- 6QN208C	LFE3-17EA- 7FTN256CES	LFSC3GA15 E-6F256C
Resource Utilization	Data Path Width	32					
	LUTs	900					
	Registers	500					
Design Tool Support	Lattice Implementation	Diamond 1.0 or ispLEVER 8.1					
	Synthesis	Synopsys Synplify Pro for Lattice D-2009.12L-1					
		Mentor Graphics Precision RTL					
	Simulation	Aldec Active-HDL 8.2 Lattice Edition					
Mentor Graphics ModelSim SE 6.3F							

Table 1-7. PCI IP Core Quick Facts--PCI target 33MHz/64bit

		PCI IP configuration					
		PCI target 33MHz 64bit					
Core Requirements	FPGA Families Supported	LatticeEC LatticeECP	Lattice ECP2 Lattice ECP2M	LatticeXP	LatticeXP2	LatticeXP3	LatticeSC LatticeSCM
	Minimal Device Needed	LFEC6E- 5F484C	LFE2-12E- 6F484C	LFXP10C- 5F388C	LFXP2-8E- 6FT256C	LFE3-17EA- 7FN484CES	LFSC3GA15E -6F900C
Resource Utilization	Data Path Width	64					
	LUTs	800					
	Registers	600					
Design Tool Support	Lattice Implementation	Diamond 1.0 or ispLEVER 8.1					
	Synthesis	Synopsys Synplify Pro for Lattice D-2009.12L-1					
		Mentor Graphics Precision RTL					
	Simulation	Aldec Active-HDL 8.2 Lattice Edition					
Mentor Graphics ModelSim SE 6.3F							

Table 1-8. PCI IP Core Quick Facts--PCI target 33MHz/32bit

		PCI IP configuration							
		PCI target 33MHz 32bit							
Core Requirements	FPGA Families Supported	MachXO	MachXO2	LatticeEC LatticeECP	Lattice ECP2 Lattice ECP2M	LatticeXP	LatticeXP2	LatticeXP3	LatticeSC LatticeSCM
	Minimal Device Needed	LCMXO1200 E-5FT256C	LCMXO- 1200HC- 6TG144CES	LFEC3E- 5Q208C	LFE2-6E- 6F256C	LFXP3C- 5Q208C	LFXP2-5E- 6QN208C	LFE3-17EA- 7FTN256CES	LFSC3GA15 E-6F256C
Resource Utilization	Data Path Width	32							
	LUTs	600							
	Registers	500							
Design Tool Support	Lattice Implementation	Diamond 1.0 or ispLEVER 8.1							
	Synthesis	Synopsys Synplify Pro for Lattice D-2009.12L-1							
		Mentor Graphics Precision RTL							
	Simulation	Aldec Active-HDL 8.2 Lattice Edition							
Mentor Graphics ModelSim SE 6.3F									

Features

- Available as 32/64-bit PCI bus and 32/64-bit local bus
- PCI SIG Local Bus Specification, Revision 3.0 compliant
- 64-bit addressing support (dual address cycle)
- Capabilities list pointer support
- Parity error detection
- Up to six Base Address Registers (BARs)
- Fast back-to-back transaction support
- Supports zero wait state transactions
- Special cycle transaction support
- Customizable configuration space
- Up to 66MHz PCI
- Fully synchronous design

Functional Description

This chapter provides a functional description of the Lattice PCI IP core.

The PCI IP cores bridge the PCI bus to the back-end application. They decode transactions and pass PCI requests to the Local Interface. The back-end applications then send or receive the proper data associated with the PCI Interface via their Local Interface to respond to the PCI transactions. In the case of master versions the core executes PCI bus transactions based on back-end requests. [Figure 2-1](#) illustrates the functional modules and internal bus structure used in the PCI IP core.

Block Diagram

Figure 2-1. PCI IP core Block Diagram



Note: Signals in shaded boxes are used for 64-bit PCI Cores.

The PCI Master Target IP Core consists of multiple blocks, as shown in [Figure 2-1](#). This section provides a detailed description of these blocks.

PCI Master Control

The PCI Master Control interfaces with the PCI bus. It supports all of the address and command signals required to execute transactions on the PCI bus for both 32-bit and 64-bit PCI applications. A list of the supported PCI signals is available in the PCI Interface Signals section of this document. Once the Local Master Interface Control is granted the bus, it passes the transaction information to the PCI Master Control using the internal bus. The PCI Master Control then requests and executes the transaction on the PCI bus. The PCI IP cores support all of the

commands specified in the *PCI Local Bus Specification, Revision 3.0*. [Table 2-1](#) lists the supported PCI commands.

Table 2-1. PCI IP Core Command Support

cben[3:0]	Command	Support
0000	Interrupt Acknowledge	Yes
0001	Special Cycle	Yes
0010	I/O Read	Yes
0011	I/O Write	Yes
0100	Reserved	Ignored
0101	Reserved	Ignored
0110	Memory Read	Yes
0111	Memory Write	Yes
1000	Reserved	Ignored
1001	Reserved	Ignored
1010	Configuration Read	Yes
1011	Configuration Write	Yes
1100	Memory Read Multiple	Yes
1101	Dual Address Cycle	Yes
1110	Memory Read Line	Yes
1111	Memory Write and Invalidate	Yes

The PCI Master control supports data transfer requirements for both high and low throughput back-end applications. It maintains up to the maximum 528 MBytes per second (MBps) burst data transfer rate when operating at 66MHz with a 64-bit data bus. The Advanced Master Transactions section of this document describes burst data transfers in further detail. For slower applications, single data phase transactions can also be easily implemented. The Basic PCI Master Read and Write Transactions section describes these basic transactions in detail.

PCI Target Control

The PCI Target control interfaces with the PCI bus. It processes the address, data, command and control signals to transfer data to and from the PCI IP core for both 32-bit and 64-bit PCI applications. A list of the supported PCI signals is available in the PCI Interface Signals section. Once the PCI Target control detects a transaction, it passes the transaction information to the Local Interface control using the internal bus. It also responds to most Configuration Space accesses with no intervention from the Local Interface. The PCI IP core supports all of the commands specified in the *PCI Local Bus Specification, Revision 3.0*. [Table 2-1](#) lists the supported PCI commands.

When designing for a particular target application, the back-end target design may not support all the commands listed in [Table 2-1](#). As a result, the PCI IP core does not transfer data using those commands. For cases where the back-end target application does not support all the commands, it must issue the proper termination as described in the Target Termination section of this document.

The PCI Target control supports the data transfer requirements for both high and low throughput back-end applications. It can maintain a 528 MBps transfer rate during burst transactions when operating at 66MHz with a 64-bit data bus. The Advanced Target Transactions section describes the Burst transactions in further detail. For slower applications, single data phase transactions can also be easily implemented. The Basic PCI Target Read and Write Transactions section describes the these basic transactions in detail

Local Master Interface Control

The Local Master Interface facilitates master transactions on the PCI Bus with the commands listed in [Table 2-1](#). The Local Master Interface Control passes the local master transaction request from the user's application to the PCI Master Control which then executes the PCI bus transaction.

Local Target Control

The Local Target Control responds to target transactions on the PCI bus. Fully decoded BAR select signals (`bar_hit`) and new capabilities select signal (`new_cap_hit`) are provided by the Local Target Control to indicate that the PCI IP core has been selected for a transaction. Registered address and command signals are available at the Local Interface from the Local Interface Control for the back-end application to properly handle the core's request. Additionally, the Local interface also supplies Configuration Space Register signals and a local interrupt request (`l_interruptn`) for users' applications. A full list of Local Interface signals and descriptions is available in the Local Interface Signals section.

Configuration Space

The Configuration Space implements all the necessary Configuration Space registers required to support a single-function PCI IP core. It provides the first 64 bytes of header type 0, which is used for all device types other than PCI-to-PCI and CardBus bridges. The first 64 bytes of the predefined header region contain fields that uniquely identify the device and allow the device to be generically controlled. This predefined header portion of the Configuration Space is divided into two parts. The first 16 bytes of the header are defined the same way regardless of the type of device. The remaining bytes have different definitions depending on the functionality that the PCI IP core supports. These bytes include six Base Address Registers (BARs), the Capabilities Pointer (Cap Ptr), and the registers that control the interrupt capability. Refer to the Configuration Space Set-up section for additional information on the Configuration Space.

Accesses to the first 64 bytes of the Configuration Space are completed by the PCI IP core control with no intervention from the Local Target Interface control. Access beyond the first 64 bytes, such as the Capabilities List, is left to the Local Target Interface control. These transactions are described in the Advanced Configuration Accesses section.

Parity Generator and Checker

Parity checking must occur on every PCI address and data cycle to be compliant with the *PCI Local Bus Specification, Revision 3.0*. The PCI IP core's Parity Generator and Checker module does all parity checking for the PCI device. The Parity Generator and Checker determines if the master is successful in addressing the desired target. It also verifies that data transfers occur correctly between the master and target devices. The address and byte enable signals are included in every calculation to ensure accuracy. Each address and data cycle that occurs on the PCI bus is checked for errors.

The parity check signals `perrn` and `serrn` are enabled or disabled using bit 6 and bit 8 of the PCI Command Register, which is part of the Configuration Space.

Signal Descriptions

Pin Assignments for the evaluation configurations are shown [“Pin Assignments For Lattice FPGAs” on page 161](#). Final selection of the pinouts is left to the designer to allow for maximum flexibility in the design. Pinouts are defined in the HDL source code, or as follows:

- In Diamond, choose **View > Show Views > File List**, double-click the `lpf` file, and edit the file to add pin location preferences.
- In ispLEVER, double-click **Edit Preference (ASCII)** in the Processes window, and edit the file in the Text Editor to add pin location preferences.

Refer to the Diamond or ispLEVER software help for additional information.

There are five types of signals defined in [Table 2-2](#).

Table 2-2. Signal Types

Signal Type	Description
in	Input is a standard input only signal.
out	Output is a standard output only signal.
t/s	Tri-state is a bidirectional, tri-state input/output pin.
s/t/s	Sustained Tri-State is an active low tri-state signal owned and driven by one agent at a time.
o/d	Open Drain allows multiple devices to share as a wire-OR. A pull-up is required to sustain the inactive state until another agent drives it and must be provided by the central resource.

PCI Interface Signals

The PCI Interface signals correspond to the PCI bus specification. [Table 2-3](#) shows the input and output signals for the PCI IP core. These are the signals required by the PCI IP core to handle PCI bus side transactions. [Table 2-3](#) describes each signal.

In addition to the signals required by the PCI IP core, there are some signals on the PCI Bus, referred to as “Additional Signals” in the PCI specifications, which must be handled appropriately to insure proper PCI IP core functions in a system. Refer to the relevant PCI specifications for a description of those Additional Signals (which are beyond the scope of this document). Examples of this type of signal are `M66EN` and `PRSENT[1:0]`.

Table 2-3. PCI IP Core Signals¹

Name	I/O	Polarity	Description
PCI System			
clk	in	—	The PCI system clock provides timing for all transactions. The clock frequency operates up to 66MHz. This clock is also used to provide timing to the Local Interface.
rstn	in	low	The asynchronous PCI system reset is used to set the PCI device to a starting known and stable state.
PCI Address and Data			
ad[31:0]	t/s	—	The multiplexed address and data bus.
cben[3:0]	t/s	—	Multiplexed command and byte enable signals.
par	t/s	—	The <code>par</code> signal generates even parity for <code>ad[31:0]</code> and <code>cben[3:0]</code> signals
PCI Interface Control			
framen	s/t/s	low	The <code>framen</code> signal is driven by the current master and used to indicate the start of cycle and the duration of the cycle.
irdyn	s/t/s	low	The initiator ready signal indicates that the current master is ready for the data phase.
trdyn	s/t/s	low	The target ready signal indicates that the current target is ready for the data phase.
stopn	s/t/s	low	The PCI IP core, as a target, drives this signal low requesting to stop the current transaction.
idsel	in	—	The initialization device select is used to select a target for configuration reads and writes.
devseln	s/t/s	low	Device select is actively driven by the PCI IP core to indicate that it is the target of the bus transaction.

Table 2-3. PCI IP Core Signals¹ (Continued)

Name	I/O	Polarity	Description
PCI Error Reporting			
perrn	s/t/s	low	Data parity error is used to report parity errors in the data phase.
serrn	o/d	low	System error is used to indicate catastrophic errors.
PCI Interrupt			
intan	o/d	low	Interrupt A is used to request an interrupt.
PCI Bus Arbitration			
reqn	out	low	Request for the use of PCI bus.
gntn	in	low	Grant the master's access to PCI bus.
PCI 64-Bit Extension			
ad[63:32]	t/s	—	The upper 32 bits of multiplexed address and data bus.
cben[7:4]	t/s	—	The upper, multiplexed command and byte enable signals for 64-bit applications.
par64	t/s	—	The par64 signal generates even parity for ad[63:32] and cben[7:4] signals.
req64n	s/t/s	low	Used by the master to request a 64-bit data transaction.
ack64n	s/t/s	low	Signal used to indicate the acknowledgement of a request for 64-bit data transaction.

1. Shaded rows apply to 64-bit applications.

Local Interface Signals

The Local Interface provides all the necessary address and control signals to respond to and initiate transactions associated with the PCI bus. Command and status information are also available at the Local Interface, so the back-end application logic can essentially monitor the PCI bus. [Table 2-4](#) contains the Local Interface signals that are divided into three different categories: Local Bus Signals, Local Target Bus signals and Local Master Bus signals.

The Local Bus Signals are shared between the Local Master Interface and Local Target Interface. These signals are typically denoted with an “l_”. The Local Target Bus signals are used by the Local Target Interface and are denoted using “lt_”. The Local Master Bus signals are used by the Local Master interface and are denoted using “lm_”.

Table 2-4. Local Interface Signals¹

Name	I/O	Polarity	Description
Local Address and Data			
l_ad_in[31:0]	in	—	Local address/data input. The address input is used in Master Read/Write transactions, and the data input is used for master write/target read transactions
l_data_out[31:0]	out	—	Local Data output. Local side lower DWORD data output for a master read or a target write.
lt_address_out [31:0]	out	—	The local address bus for target read and write. This bus indicates the start address of the transaction. The bus, lt_address_out [31:0], is latched one clock after the framen signal is asserted on each transaction and remains unchanged until the next transaction.
lt_cben_out [3:0]	out	low	The local byte enables for target read and write. The lt_cben_out [3:0] determine which byte lanes of l_data_out [31:0] or l_ad_in[31:0] carry meaningful data.
lt_command_out [3:0]	out	—	The lt_command_out [3:0] latches the command information during the address phase of a PCI cycle. It indicates the PCI bus command for the current cycle (refer to Table 2-1).
lm_cben_in[3:0]	in	low	Local master command and byte enables.

Table 2-4. Local Interface Signals¹ (Continued)

Name	I/O	Polarity	Description
Local 64-Bit Extension			
l_ad_in[63:32]	in	—	Local address/data input. The address input is used in Master Read/Write transactions, and the data input is used for master write/target read transactions.
l_data_out[63:32]	out	—	Local Data output. Local side upper DWORD data output for a master read or a target write.
lt_address_out[63:32]	out	—	The local address bus for target read and write. This bus is valid only for 64bit address bar. The 64-bit combined signal lt_address_out[63:0] indicates the start address of the transaction. The high 32bit of the bus, lt_address_out[63:32], is latched two clock cycles after the framen signal is asserted on each transaction (only for dual address cycle) and remains unchanged until the next transaction.
lt_cben_out[7:4]	out	low	The local byte enables for 64-bit target read and write. The lt_cben_out[7:4] determine which byte lanes of l_data_out[63:32] or l_ad_in[63:32] carry meaningful data.
lt_ldata_xfern	out	low	This signal works same as lt_data_xfern. It applies to lower DWORD when local bus is 64bit.
lt_hdata_xfern	out	low	This signal works same as lt_data_xfern. It applies to upper DWORD when local bus is 64bit.
lt_64bit_transn	out	low	Signal to the local target that a 64-bit read or write transaction is underway on pci bus.
lm_ldata_xfern	out	low	This signal works same as lm_data_xfern. It applies to lower DWORD when local bus is 64bit.
lm_hdata_xfern	out	low	This signal works same as lm_data_xfern. It applies to upper DWORD when local bus is 64bit.
lm_64bit_transn	out	low	Signal to the local master that a 64-bit read or write transaction is underway on PCI bus.
lm_cben_in[7:4]	in	low	Local master byte enables.
Local Interrupt			
l_interruptn	in	low	The local side interrupt request indicates that the Local Interface is requesting an interrupt. This signal asserts the PCI side interrupt signal, intan, if interrupts are enabled in the Configuration Space.
Config Register			
cache[7:0]	out	—	The cache signal indicates the cache length in the cache registers defined in the Configuration Space
command[9:0]	out	—	Command register bits from the Configuration Space. Bit 0 - I/O space enable, Command[0] Bit 1 - Memory space enable, Command[1] Bit 2 - Master enable, Command[2] Bit 3 - Special cycles enable, Command[3] Bit 4 - Memory write and invalidate enable, Command[4] Bit 5 - VGA Palette Snoop, Command[5] Bit 6 - Parity Error Response, Command[6] Bit 7 - Reserved Bit 8 - SERR# enable, Command[8] Bit 9 - Fast back-to-back enable, Command[9]
status[5:0]	out	—	Status register bits from the Configuration Space. Bit 0 - Master Data Parity Error, Status[8] Bit 1 - Signaled Target Abort, Status[11] Bit 2 - Received Target Abort, Status[12] Bit 3 - Received Master Abort, Status[13] Bit 4 - Signaled System Error with SERR#, Status[14] Bit 5 - Detected Parity Error, Status[15]

Table 2-4. Local Interface Signals¹ (Continued)

Name	I/O	Polarity	Description
Local Target Interface			
lt_abortn	in	low	Local target abort request is used to request a target abort on the PCI bus.
lt_disconnectn	in	low	Local target disconnect (or retry) is used to request early termination of a bus transaction on the PCI bus.
lt_rdyn	in	low	Local target ready signal indicates that the Local Interface is ready to receive or send data.
lt_r_nw	out	—	Read/Write (read/not write) to signal whether the current transaction is a read or write. 1 = read, 0 = write
lt_accessn	out	low	Local target can access local interface if lt_accessn is active. Once lt_accessn active, local target needs to be ready for next process based on lt_command_out. lt_accessn is active during either of active bar_hit, exprom_hit or new_cap_hit. It is also active during special cycle command.
lt_data_xfern	out	low	This signal indicates local input data (l_ad_in) being read or local output data (l_data_out) being available at current clock cycle. When lt_data_xfern is active, if core reads data from l_ad_in, back-end can update l_ad_in for next data at next clock cycle. If core writes data on l_data_out, back-end can get valid data from l_data_out. It is only used when the local bus is 32 bits.
Local Target Address Decode			
bar_hit [5:0]	out	high	The bar_hit signal indicates that the master is requesting a transaction that falls within one of the Base Address register ranges.
new_cap_hit	out	high	New Capabilities List hit. new_cap_hit indicates that the master is requesting a Configuration Space register out of internal registers (00h-3fh), that is 40h-FFh., Although the hardware associated with the New Capabilities reside in the back-end logic, logically they are part of the PCI Configuration Space.
Local Master req/gnt			
lm_req32n	in	low	Local master 32-bit data transaction request.
lm_req64n	in	low	Local master 64-bit data transaction request.
lm_gntn	out	low	Signal to the local master that gntn is asserted.
Local Master Interface Control			
lm_rdyn	in	low	Local master is ready to receive data (read) or send data (write)
lm_burst_length [11:0]	in	—	Local master burst length determines the number of data phases in the transaction. For single data phase, it should be set to 1. lm_burst_length set to 0 means the burst length is 13'b1,0000,0000,0000.
lm_data_xfern ³	out	low	This signal indicates local input data (l_ad_in) being read or local output data (l_data_out) available at current clock cycle. When lt_data_xfern is active, if core reads data from l_ad_in, back-end can update l_ad_in for next data at next clock cycle. If core writes data on l_data_out, back-end can get valid data from l_data_out. It is only used when the local bus is 32 bits. In a single data phase, it should be set to 1. lm_burst_length set by 0 means the length is 13'b1,0000,0000,0000.
lm_r_nw	out	—	(Read/Write) to signal whether the current transaction is a read or write. 1 = read, 0 = write
lm_timeoutn	out	—	Indicates that the transaction has timed out.
lm_abortn	in	—	Local master issues an abort to terminate a cycle that can not be completed.

Table 2-4. Local Interface Signals¹ (Continued)

Name	I/O	Polarity	Description
lm_status[3:0]	out	—	Indicate the master operation status. 0001 - Address loading 0010 - Bus transaction 0100 - Bus termination 1000 - Fast_back_to_back
lm_termination[2:0]	out	—	Indicate the master termination status. 000 - Normal termination Normal termination occurs when the master finishes and completes the transaction normally. During a multi-data phase transfer, a condition can occur where the master's latency timer expires on the last data phase and master's gntn has been de-asserted. In this case, lm_timeoutn is asserted and the master also indicates this as Normal termination. 001 - Timeout termination Timeout termination occurs when, during a multi-data phase transfer, the master's latency timer expired before the last data phase and the master's gntn is de-asserted on or before the last data phase. lm_timeoutn is also asserted in this case. 010 - No target response termination. This is also known as Master Abort termination. 011 - Target abort termination 100 - Retry termination 101 - Disconnect data termination 110 - Grant abort termination 111 - Local master termination
lm_burst_cnt[12:0]	out	—	Local master burst transaction "down counter" value. When the local master requests a 32-bit transaction, the initial value of lm_burst_cnt is equal to lm_burst_length. When the local master requests a 64-bit transaction and lm_64bit_transn is active, the initial value of lm_burst_cnt is equal to lm_burst_length. When the local master requests a 64-bit transaction and lm_64bit_transn is inactive, the initial value of lm_burst_cnt is double of lm_burst_length.

1. Shaded rows apply to 64-bit applications.
2. A Memory Write and Invalidate transaction is not governed by the Latency Timer except at cacheline boundaries. A master that initiates a transaction with the Memory Write and Invalidate command ignores the Latency Timer until a cacheline boundary. When the Latency Timer has expired (and gntn is deasserted), the core asserts lm_timeoutn. The backend must terminate the transaction at next cacheline boundary by asserting lm_abort.
3. During Master Read operation the signal lm_data_xfern always reflects valid data in the local data bus. But during Master Write operation, due to data prefetch ahead of the transactions on PCI bus, lm_data_xfern along with the lm_status reflects the data validity. If lm_status is 0100, (meaning a Bus Termination) ignore the lm_data_xfern assertion because the data being prefetched is not sent out on the PCI bus due to termination.

PCI Configuration Space Setup

Determining the correct settings for the Configuration Space is an essential step in designing a PCI application, because the device may not function properly if the Configuration Space is not properly configured. The PCI IP core supports all of the required and some additional Configuration Space registers that apply to the PCI IP core (refer to *PCI Local Bus Specifications, Revision 3.0*, Chapter 6). [Figure 2-2](#) shows the supported Configuration Space for the PCI IP core. This section describes the first 64 bytes of the Configuration Space in the PCI IP core and its customization method. For more information on the parameters used to customize the Configuration Space, refer to the Lattice PCI IP core Configuration Options section.

Figure 2-2. PCI IP Core Configuration Space

Device ID		Vendor ID		00h
Status Register		Command Register		04h
Class Code			Revision ID	08h
BIST	Header Type	Latency Timer	Cache Line Size	0Ch
Base Address 0				10h
Base Address 1				14h
Base Address 2				18h
Base Address 3				1Ch
Base Address 4				20h
Base Address 5				24h
Cardbus CIS Pointer				28h
Subsystem ID		Subsystem Vendor ID		2Ch
Expansion ROM Base Address				30h
Reserved			Cap Ptr	34h
Reserved				38h
MAX_LAT	MIN_GNT	Interrupt Pin	Interrupt Line	3Ch

Note: Shaded sections indicate reserved and unused sections in the configuration space. All unused and reserved registers return 0s.

Vendor ID: The Vendor ID is a 16-bit, read-only field used to identify the manufacturer of the product. The Vendor ID is set using the `VENDOR_ID` parameter. The Vendor ID is assigned by the PCI SIG to ensure uniqueness. Contact PCI SIG (www.pcisig.org) to obtain a unique Vendor ID.

Device ID: The Device ID is a 16-bit, read-only field that is defined by the manufacturer used to uniquely identify a particular product or model. The Device ID is set using the `DEVICE_ID` parameter. Its default value is 0000h.

Revision ID: The Revision ID is an 8-bit, read-only device-specific field that is set using the `REVISION_ID` parameter. This field is used by the manufacturer and should be viewed as an extension of the Device ID to distinguish between different functional versions of a PCI product.

Class Code: The Class Code is a 24-bit, read-only register and is used to identify the generic functionality of a device. The value of this register is determined by the `CLASS_CODE` parameter. The Class Code is broken up into three bytes. The upper byte holds the base class code; the middle byte holds the sub-class code. In addition, the lower byte holds the programming interface. The Class Code information is located in the *PCI Local Bus Specification, Revision 3.0*. The default setting for this register is FF0000h.

Command Register: The Command Register is a 16-bit read/write register that provides coarse control over the device. It is located at the lower 16 bits of address 04h in the Configuration Space. Using this register, the memory and I/O space can be disabled to allow only configuration accesses. This register also controls the parity error response and the `serrn` signal. [Figure 2-3](#) and [Table 2-5](#) illustrate the command register that is implemented in the PCI IP core.

Figure 2-3. Command Register



Table 2-5. Command Register Description

Bit Location	Description
0	I/O Space Enable controls a device’s response to I/O space accesses. I/O space accesses are enabled if the bit is set to a 1. After reset the I/O space enable bit is set to a 0.
1	Memory Space Enable controls a device’s response to memory space accesses. Memory space accesses are enabled if the bit is set to a 1. After reset the memory space enable bit is set to a 0.
2	Bus Master enables the PCI IP core to act as a master on the PCI bus when this bit is set to 1. After reset the Bus Master enable bit is set to a 0.
3	Special Cycle controls a device’s action on special cycle operations. Special cycle accesses are enabled if the bit is set to 1. After reset the bit is set to 0.
4	Memory Write and Invalidate Enable controls the PCI IP core’s ability to execute the Memory Write and Invalidate cycle on the PCI bus. The Core, when required, will issue the Memory Write and Invalidate command if this bit is set to a 1. After reset this bit is set to a 0.
5	VGA Palette Snoop
6	Parity Error Response is used to control a device’s response to parity errors. If the bit is 0, a parity error causes the Detected Parity Error status bit to be set in the status register but does not drive the <code>perrn</code> signal. After reset the bit is set to 0. This is the enable for parity error checking. However, even with the <code>perrn</code> signal disabled, the device is still required to generate parity.
7	Reserved Bit
8	SERR Enable is used to enable the <code>serrn</code> driver. To enable, this bit is set to a 1. After reset this bit is set to 0.
9	Fast Back-to-Back Enable allows the PCI IP core to execute fast back-to-back transactions to different devices. If the fast back-to-back enable is set to a 1, the Core executes fast back-to-back transactions. After reset this bit is set to 0.
10-15	Reserved Bits The returned value for these bits is 0 when this register is read.

Status Register

The Status Register is a 16-bit read/write register that provides information on the capabilities of the PCI IP core. It also reports the error status of the PCI IP core. The Status Register is located at the upper 16 bits of register location 04h. Writes to the Status Register from the PCI bus are slightly different, given that bits can be reset but not set. Writing a 1 to a bit in the status register resets it, but only if the current value of the bit is a 1. Writing a 0 to a bit has no effect. Figure 2-4 and Table 2-6 describe the Status Register that is implemented in the PCI IP core.

Figure 2-4. Status Register



Table 2-6. Status Register Descriptions

Bit Location	Description
4	Capabilities List is a read-only bit that indicates whether or not the device contains an address pointer to the start of the Capabilities list. The bit is set to a 1 to indicate that the Capabilities Pointer at location 34h is valid. After reset the value is set to a 0. The <code>CAP_PTR_ENA</code> parameter initializes this bit.
5	66MHz Capable is a read-only bit that is used to indicate that the device is capable of running at 66MHz. The bit is set to a 1 if the device is 66MHz capable. The <code>PCI_66MHZ_CAP</code> parameter initializes this bit.
7	Fast Back-to-Back Capable is a read-only bit that indicates if the device is capable of handling fast back-to-back transactions. The bit is set to a 1 if the device can accept these transactions. The <code>FAST_B2B_CAP</code> parameter initializes this bit.
8	Master Data Parity Error indicates that the bus master has detected a parity error during a transaction. A value of 1 means a parity error has occurred. After rest the bit is set to 0.
9-10	DEVSEL Timing bits indicate the slowest time for a device to assert the devseln signal for all accesses except the configuration accesses. The PCI IP core only supports the slow decode setting. The <code>DEVSEL_TIMING</code> parameter (bits 2 and 1) determines the DEVSEL timing. 00 - Fast (not supported) 01 - Medium (not supported) 10 - Slow 11 - Reserved
11	Signaled Target Abort is set when the target terminates the cycle with a Target-Abort. Writing a 1 clears the Signaled Target Abort.
12	Received Target Abort is set to a 1 by the Core after it terminates a cycle with a target abort.

Table 2-6. Status Register Descriptions (Continued)

Bit Location	Description
13	Received Master Abort is set to a 1 by the Core after it terminates a cycle with a master abort with the exception of special cycles.
14	Signaled System Error with <code>serrn</code> is set when the device asserts <code>serrn</code> . Writing a one clears the bit.
15	Detected Parity Error is used to indicate a parity error even if the parity error handling is disabled.
0,1,2,3,6	Reserved Bits The returned value for each of these bits is 0 when this register is read.

Base Address Registers

The PCI IP core supports up to six Base Address Registers (BARs) for Master/Target and Target configurations. The BAR holds the base address for the PCI IP core, and it is used to point to the starting address of the PCI IP core in the system memory map. They are configured differently based on whether they are mapped in memory or I/O space. A memory location is addressed using 32 bits or 64 bits while I/O locations are limited to 32-bit addresses. The six BARs consist of 192 bits in the Configuration Space and are located in address locations 0x10 to 0x27.

BAR Mapped to Memory Space

When selecting the amount of required memory for a BAR, the amount of memory is saved to the `BAR0`-`BAR5` parameters in its 2's complement form. Bits 0 through 3 of a memory BAR describes the attributes of the BAR and do not change. The minimum recommended amount of memory a BAR should request is 4Kbytes. [Figure 2-5](#) and [Table 2-7](#) describe the configuration of a BAR for memory space.

Figure 2-5. Memory Base Address Register

SERR Enable is used to enable the `serrn` driver. To enable, this bit is set to a 1. After reset this bit is set to 0.

Table 2-7. Memory Base Address Register

Bit Location	Description
0	Memory/I/O Space Indicator indicates whether the base address is mapped to I/O or memory space. A 0 indicates mapping to the memory space. The value of this bit is set by bit 0 of the <code>BAR0</code> - <code>BAR5</code> parameters.
1-2	Base Address Type is used to determine whether the BAR is mapped into a 32-bit or 64-bit address space. These bits have the following meaning: 00 - located in 32-bit address space 01 - reserved 10 - located in 64-bit address space 11 - reserved
3	Prefetchable Enable is determined by bit 3. It is a read-only bit that indicates if the memory space is prefetchable. A value of 1 means the memory space is prefetchable. Bit 3 of the <code>BAR0</code> - <code>BAR5</code> parameters sets the value of this bit.
4-31/63	Bits 4-31/63 are read/write to hold memory address and are initialized by the <code>BAR0</code> - <code>BAR5</code> parameters.

Bar Mapped to I/O Space

When selecting the amount of required I/O space for a BAR, the amount is saved to the `BAR0`-`BAR5` parameters in its 2's complement form. Bits 0 and 1 of an I/O BAR describe the attributes of the BAR and do not change. [Figure 2-6](#) and [Table 2-8](#) describe the configuration of a BAR for I/O space.

Figure 2-6. I/O Base Address Register



Table 2-8. I/O Base Address Register

Bit Location	Description
0	Memory/I/O space Indicator indicates whether the base address is mapped to I/O or memory space. A 0 indicates mapping to the memory space. The value of this bit is set by bit 0 of the <code>BAR0</code> - <code>BAR5</code> parameters.
1	Bit 1 is reserved and hardwired to 0. This bit is read only.
2-31	Bits 2-31 are read/write to hold the memory address and are initialized by the <code>BAR0</code> - <code>BAR5</code> parameters.

Cache Line Size

The Cache Line Size register is an 8-bit read/write register, located at 0Ch. It specifies the Cache Line Size in Double Words (DWORDs). During a reset the register is set to 00h. This register is output to local interface as `cache [7:0]`.

Latency Timer

The Latency Timer register is an eight-bit read/write or read only register, located at byte address 0Dh. It specifies the Master Latency Timer value for a PCI Master on the PCI bus. During reset the register is set to 00h.

CardBus CIS Pointer

The CardBus CIS Pointer is a read-only, 32-bit register at location 28h in the Configuration Space. The `CIS_POINTER` parameter determines the value of the register. For more information on the CardBus CIS Pointer, refer to the CardBus specification.

Subsystem Vendor ID

The Subsystem Vendor ID is a 16-bit, read-only field and is used to further identify the manufacturer of the expansion board or subsystem. The `SUBSYSTEM_VENDOR_ID` parameter determines the value of the Subsystem Vendor ID register. The PCI SIG assigns the Vendor ID to ensure uniqueness. Contact PCI SIG (www.pcisig.org) to attain a unique Subsystem Vendor ID.

Subsystem ID

The Subsystem ID is a 16-bit, read-only field and is used to further identify the particular device. This field is defined by the manufacturer and is used to uniquely identify products or models. The `SUBSYSTEM_ID` parameter determines the value of this register.

Capabilities Pointer

The Capabilities Pointer indicates the starting location of the Capabilities List. It resides at address location 34h. The Capabilities Pointer consists of an 8-bit read-only register location. The capabilities pointer must be enabled by the `CAP_PTR_ENA` parameter. The `CAP_POINTER` parameter determines the value of this register.

Min_Gnt

The `Min_Gnt` read-only register is an 8-bit field that is used to specify the length of time in microseconds for the Master to control the PCI bus. It resides in the upper 8 bits of address location 3Ch. The `MIN_GRANT` parameter determines the value of this register.

Max_Lat

The `Max_Lat` read-only register is an 8-bit field that is used to specify the how often the PCI IP core the bus. It resides in the third byte of address location 3Ch. The `MAX_LATENCY` parameter determines the value of this register.

Interrupt Line

The Interrupt Line register is set by the interrupt handling mechanism to define the interrupt routing. This is a read/write register is handled outside the operation of the PCI IP core. This register holds system interrupt routing information.

Interrupt Pin

The Interrupt Pin register is used to indicate which of the four interrupts that the PCI IP core uses. Because the PCI IP core is a single function device, the only Interrupt Pin that can be selected is Interrupt A. If the interrupt is selected, the `INTERRUPT_PIN` parameter sets the register with a value of 01h. This eight-bit register is located at address location 3Dh.

Reserved

All reserved registers are read-only. Write operations to reserved registers are completed normally, and the data is discarded. A 0 is returned after the read operations to reserved registers are completed normally.

Lattice PCI IP core Configuration Options

Lattice PCI IP core allows an extensive definition of the PCI Configuration Space for optimum performance.

IPexpress User-Controlled Configurations

The IPexpress user-configurable flow provides evaluation capability for any valid combination of parameters. Configurations can have a maximum of three BARs. To create a configuration with more than three BARs, contact Lattice.

The evaluation configurations of PCI IP core have a maximum of three BARs. To order a configuration with more than three BARs, contact Lattice.

Table 2-9. IPexpress Parameters for PCI IP Core

Parameter Name	Range	Default(s)
Number of BARs	1-6	3
Bus Definition Parameters		
PCI Data Bus Size	32- or 64-bit	Note 1
Local Master Data Bus Size	32- or 64-bit	Note 2
Local Target Data Bus Size	32- or 64-bit	Note 2

Table 2-9. IPexpress Parameters for PCI IP Core

Parameter Name	Range	Default(s)
Local Address Bus Width	32- or 64-bit	32-bit

1. The value for PCI Data Bus size is set in each eval configuration as described in the appendices of the PCI IP core data sheet.
2. For 32-bit PCI Data Bus, only 32-bit Local Data Bus sizes are supported. For 64-bit PCI Data Bus, only 64-bit Local Data Bus sizes are supported.

PCI Configuration Using Core Configuration Space Port

A set of signals called the Configuration Space Port is provided at the local bus side of the core to allow the user to define the PCI configuration space as required for the user's system. The names of these Core configuration input signals are all suffixed with `_p`.

Appropriate parameter values are to be assigned to the designated input signals of Core configuration space port to implement the desired PCI configuration space. Here are two examples to achieve this:

1. Directly assign parameter values to the input signals of Core configuration space port. The user needs to provide hard coded values to the Core's Configuration Space Port input signals in the core instantiation.

```

module pci_top();
...
customer_design    cus_design _inst(
    .xxxx(xxxx) ,
    .yyyy(yyyy) ,
    .....
    .zzzz(zzzz)
);

pci_core    core_inst( .framen(framen),
...
    .vdr_id_p(16'h1234),    //vendor_id = 16'h1234
...
    .dev_tim_p(2'b10),    //devsel_timing = 2'b10 (slow)
...
);
endmodule

```

2. Typically, two Verilog files, `para_cfg.v` and `PCI_params.v`, can be used to load these parameters to Core's Configuration Space Port. These files are available in Lattice PCI IP release package.

- Edit the `PCI_params.v` to set correct values to the parameters. Parameter names in `PCI_params.v` are all suffixed with `_g`. Alternatively use the PCI GUI provided with Lattice's software design tools to generate the `PCI_params.v`. Refer the note given below.
- Instantiate `para_cfg` module and appropriately connect its ports to the Core configuration input signals of PCI IP core.

`para_cfg` module will load the parameters, defined in `PCI_params.v`, into the Core's Configuration Space Port input signals.

```

module pci_top();
...
wire    [15:0]    vdr_id;
wire    [ 1:0]    dev_tim;
...
...

```

```

customer_design_instantiation(
    .xxxx(xxxx) ,
    .yyyy(yyyy) ,
    .....
    .zzzz(zzzz)
    ;

pci_core    core_inst(
    . framen(ramen) ,
    ...
    . vdr_id_p (vdr_id) ,    //vendor_id = VENDOR_ID_g
    ...
    . dev_tim_p (dev_tim) ,    //devsel_timing = DEVSEL_TIMING_g
    ...
    );

para_cfg    para_cfg_inst(.vdr_id_p (vdr_id) ,
    ...
    . dev_tim_p (dev_tim) ,
    ...
    );

endmodule

```

Table 2-10 shows the parameter signals and associated define values in PCI_params.v.

NOTE: There is a GUI provided with this PCI IP for the purpose of selecting the core's parameter values. Once installed into Lattice's Diamond or ispLEVER software design tools, the GUI can be accessed through the IPexpress™ tool. The GUI provides a range checking routine that ensures the selected values are within the core's valid range. If the user configures this PCI IP core outside of the GUI flow, it is the user's responsibility to ensure that the parameter values are within the valid ranges shown in Table 2-10. Parameters that are outside of the valid range will cause the PCI IP core to function improperly. The recommended flow is to follow example 2 above and use the PCI GUI to generate the params.v file. The name of this generated output file is fixed at "PCI_params.v". The user can find this file in the same directory where the <modulename>.lpc file is generated. Then, to prevent from overwriting the PCI_params.v file, the user should save a copy that is renamed to match the <module-name>.lpc file.

Table 2-10. Customer Specific Parameters

Configuration Space Port Inputs	Corresponding Parameter Name in PCI_params.v	Range	Default	Description
vdr_id_p	VENDOR_ID_g	0 - 0xFFFFE	0x0000	Value of the Vendor ID field in the Configuration Space. This sets the lower 16 bits of address 00h.
dev_id_p	DEVICE_ID_g	0 - 0xFFFF	0x0000	Value of the Device ID field in the Configuration Space. This sets the upper 16 bits of address 00h.
subs_vdr_id_p	SUB_VENDOR_ID_g	0 - 0xFFFF	0x0000	Value for Subsystem Vendor ID field in the Configuration Space. The Subsystem Vendor ID is at the lower 16 bits of register location 2Ch.
subs_id_p	SUB_SYSTEM_ID_g	0 - 0xFFFF	0x0000	Value for Subsystem ID field in the Configuration Space. The Subsystem ID is located in the upper 16 bits of address 2Ch.

Table 2-10. Customer Specific Parameters (Continued)

Configuration Space Port Inputs	Corresponding Parameter Name in PCI_params.v	Range	Default	Description
rev_id_p	REVISION_ID_g	0 - 0xFF	0x00	Value for Revision ID field in the Configuration Space. This value correlates to the lower 8 bits of register 08h.
cls_code_p	CLASS_CODE_g	0 - 0xFFFFFFFF	0x000000	Value for Class Code field in the Configuration Space. This is the value of the upper 24 bits of register 08h. Class Code is further subdivided into Base Class, Sub Class, and Interface values. Refer to the PCI local bus specification for valid Class codes.
dev_tim_p	DEVSEL_TIMING_g	00 - 2'b10	2'b10	Controls bits 9 and 10 in the status register, located at the upper 16 bits of address 04h. This parameter is used to define the decode speed of the PCI IP core. 00 - Fast (not supported) 01 - Medium (not supported) 10 - Slow 11 - Reserved
cap_list_ena_p	CAPABILITIES_LIST_ENA_g	Enabled/Disabled	Enabled	Enable for the Capabilities Pointer. It is used to set the enable bit for the Capabilities List in the PCI Status register. This bit is used to indicate if the value of the Capabilities Pointer at location 34h is valid. This is bit 4 in the status register.
cap_ptr_p	CAPABILITIES_POINTER_g	0x0 - 0xFF	0x40	Value for Capabilities Pointer field in the Configuration Space. This is an 8-bit value located at 34h.
cis_ptr_p	CIS_POINTER_g	0 - 0xFFFFFFFF	0x00000000	Value for the Cardbus CIS Pointer field in the Configuration Space. This is a 32-bit value located at 28h in the Configuration Space Settings for the CIS Pointer are beyond the scope of this document. For more information on setting this register, refer to the CardBus specification.
fast_b2b_cap_p	FAST_B2B_CAP_g	Enabled/Disabled	Enabled	Value for the Status field bit to enable fast back-to-back transfers. This is bit 7 of the status register.
irq_ack_ena_p	IRQ_ACK_ENA_g	Enabled/Disabled	Enabled	Enable response to the Interrupt Acknowledge PCI command.
int_pin_p	INTERRUPT_PIN_g	0x00 - 0x01	0x01	Value for Interrupt Pin field in the Configuration Space. If set, it allows the local interrupt signal <code>l_interruptn</code> to appear on the PCI Interrupt <code>intan</code> . If the local interrupt is not used, it must be tied high.
hdw_lat_tmr_p	HARDWIRE_LATENCY_TIMER_g	0 - 0x10	0x00	Value for read-only latency timer register
hdw_lat_tmr_ena_p	HARDWIRE_LATENCY_TIMER_ENA_g	Enabled/Disabled	Disabled	Enable read only latency timer register.
min_gnt_p	MIN_GNT_g	0 - 0xFF	0x00	Value for MIN_GRAND field in the configuration space.
max_lat_p	MAX_LAT_g	0 - 0xFF	0x00	Value for MAX_LATENCY field in the configuration space.

Table 2-10. Customer Specific Parameters (Continued)

Configuration Space Port Inputs	Corresponding Parameter Name in PCI_params.v	Range	Default	Description
pci_66mhz_cap_p	PCI_66MHZ_CAP_g	33 or 66	66	PCI value for the Status field bit to enable 66MHz. This is bit 5 in the status register. A 1 indicates that the PCI IP core is 66MHz capable, and a 0 indicates that it is not. The default value is 1.
bar_64b_dat_bus_p	BAR_64BIT_DATA_BUS_g	6'b000000 - 6'b111111	6'b000000	For 32-bit Local Data bus this parameter value is 6'b000000. For 64-bit Local Data bus this parameter value is 6'b111111.
bar0_p ¹	BAR0_g ¹	0 - 0xFFFFFFFF	0x00000000	BAR0 configuration parameter (lower half of a 64-bit BAR). The lower four bits are used for BAR definition as indicated in the PCI specification. Rest of the bits indicate the memory or I/O size supported This BAR is located at 10h. If the bar is not used, it should be 32'h00000002.
bar1_p ¹	BAR1_g ¹	0 - 0xFFFFFFFF	0x00000000	BAR1 configuration parameter (upper half of a 64-bit BAR). The lower four bits are used for BAR definition as indicated in the PCI specification. Rest of the bits indicate the memory or I/O size supported This BAR is located at 14h. If the bar is not used, it should be 32'h00000002.
bar2_p ¹	BAR2_g ¹	0 - 0xFFFFFFFF	0x00000000	BAR2 configuration parameter (lower half of a 64-bit BAR). The lower four bits are used for BAR definition as indicated in the PCI specification. Rest of the bits indicate the memory or I/O size supported This BAR is located at 18h. If the bar is not used, it should be 32'h00000002.
bar3_p ¹	BAR3_g ¹	0 - 0xFFFFFFFF	0x00000002	BAR3 configuration parameter (upper half of a 64-bit BAR). The lower four bits are used for BAR definition as indicated in the PCI specification. Rest of the bits indicate the memory or I/O size supported This BAR is located at 1Ch. If the bar is not used, it should be 32'h00000002.
bar4_p ¹	BAR4_g ¹	0 - 0xFFFFFFFF	0x00000002	BAR4 configuration parameter (lower half of a 64-bit BAR). The lower four bits are used for BAR definition as indicated in the PCI specification. Rest of the bits indicate the memory or I/O size supported This BAR is located at 20h. If the bar is not used, it should be 32'h00000002.
bar5_p ¹	BAR5_g ¹	0 - 0xFFFFFFFF	0x00000002	BAR5 configuration parameter (upper half of a 64-bit BAR). The lower four bits are used for BAR definition as indicated in the PCI specification. Rest of the bits indicate the memory or I/O size supported This BAR is located at 24h. If the bar is not used, it should be 32'h00000002.

Table 2-10. Customer Specific Parameters (Continued)

Configuration Space Port Inputs	Corresponding Parameter Name in PCI_params.v	Range	Default	Description
<p>1. When using the second method to configure parameters, only the second column is used.</p> <p>2. When a BAR is not used, its corresponding core configuration signal <code>bar_p</code> should be 32'h0000_0002. To achieve this:</p> <ul style="list-style-type: none"> • <code>BARx_g</code> value in <code>PCI_params.v</code> should be 0x0000_0000. • The file <code>para_cfg.v</code> will translate value 0x0000_0000 to 0x0000_0002. <p>In this case:</p> <ul style="list-style-type: none"> • Content of that BAR register in PCI Configuration Space is 0x0000_0000 <p>The default values shown are the read back value (using PCI read command) of the enabled BAR after all 1's are written into that BAR (using PCI write command).</p> <p>Bar Configuration Details</p> <p><u>Memory Type:</u></p> <p>Bit[0] BAR type = 0 (memory space indicator)</p> <p>Bit[2:1] Base address type:</p> <p>00 – Located in 32-bit address space 01 – Reserved 10 – Located in 64-bit address space 11 – Reserved</p> <p>Bit[3] Prefetch 1= enable, 0=disable (This bit indicates whether or not the BAR can prefetch data from memory)</p> <p>Bit[31:4] Memory size</p> <p><u>I/O Type:</u></p> <p>Bit[0] BAR type = 1 (I/O space indicator)</p> <p>Bit[1] 0 – Reserved</p> <p>Bit[31:2] Memory size</p> <p><u>Bit[31:4:2] – memory or I/O size:</u></p> <pre> 2Gbyte 32'h8000_000_x 1Gbyte 32'hC000_000_x 512Mbyte 32'hE000_000_x 256Mbyte 32'hF000_000_x 128Mbyte 32'hF800_000_x 64Mbyte 32'hFC00_000_x 32Mbyte 32'hFE00_000_x 16Mbyte 32'hFF00_000_x 8Mbyte 32'hFF80_000_x 4Mbyte 32'hFFC0_000_x 2Mbyte 32'hFFE0_000_x 1Mbyte 32'hFFF0_000_x 512kbyte 32'hFFF8_000_x 256Kbyte 32'hFFFC_000_x 128Kbyte 32'hFFFE_000_x 64Kbyte 32'hFFFF_000_x 32Kbyte 32'hFFFF_800_x 16Kbyte 32'hFFFF_C00_x 8Kbyte 32'hFFFF_E00_x 4Kbyte 32'hFFFF_F00_x 2Kbyte 32'hFFFF_F80_x 1Kbyte 32'hFFFF_FC0_x 512byte 32'hFFFF_FE0_x 256byte 32'hFFFF_FF0_x 128byte 32'hFFFF_FF8_x 64byte 32'hFFFF_FFC_x 32byte 32'hFFFF_FFE_x 16byte 32'hFFFF_FFF_x 8byte 32'hFFFF_FFF_9 4byte 32'hFFFF_FFF_D unused 32'h0000_000_2 </pre> <p>Notes to the list above:</p> <ol style="list-style-type: none"> Only I/O BAR has 8-byte or 4-byte size. For the value of “x” – please refer to the definition of Bit[3:0] as shown in the Memory BAR Configuration section of this document. Not all BARs can be set for 2Gbytes. The total BAR space in one system should not be more than 4Gbytes for a 32-bit address. 				

Local Bus Interface

Target Operation

Initially, the local target is idle. A valid transaction in the PCI bus is indicated to the local bus side by the assertion of `lt_accessn` signal. At this time either the `bar_hit`, `new_cap_hit` or `exprom_hit` signal indicates whether a BAR or New Capabilities register is selected, and `lt_command_out` indicates the current PCI command. If the command is Special Cycle, then no BAR is selected, otherwise the selected BAR needs to prepare the next process.

For a Memory Read command, local target puts data on `lt_ad_in` and asserts `lt_rdyn` to indicate data on `l_ad_in` is valid. The core will read the data and assert `lt_data_xfern` after `lt_rdyn` is active. When the transaction is burst read, the core will continue to keep asserting `lt_data_xfern` at subsequent clocks and read data on `l_ad_in` if the local side does not insert wait cycle(s).

For a Memory Write command, local target asserts `lt_rdyn` to indicate that it is ready to receive data on `l_data_out`. The core will write data on `l_data_out` and assert `lt_data_xfern` to indicate valid data on `l_data_out`. Local target should read the data on `l_data_out`.

When the local target bus width is 64 bits, the signals `lt_ldata_xfern` and `lt_hdata_xfern` are used together instead of `lt_data_xfern`. For 32-bit data width, only `lt_ldata_xfern` is used. For 64-bit data width, `lt_ldata_xfern` and `lt_hdata_xfern` are used together. The signal `lt_ldata_xfern` applies to the lower 32-bit data, `lt_hdata_xfern` applies to the upper 32 bits of data.

A target transaction is ended when `lt_accessn` becomes inactive. At this time, `bar_hit`, `new_cap_hit` and `exprom_hit` are all deasserted.

When a 32-bit BAR is hit, only the following local bus signals are used:

- `l_ad_in[31:0]`, `l_data_out[31:0]`, `lt_cben_out[3:0]` and `lt_ldata_xfern`.

and the following signals are not used:

- `l_ad_in[63:32]`, `l_data_out[63:32]`, `lt_cben_out[7:4]` and `lt_hdata_xfern`.

Master Operation

Local master starts a transaction request by asserting `lm_req32n` or `lm_req64n` when `lm_status` is in “Bus Termination” state. For a 32-bit transaction request, `lm_req32n` is asserted and `lm_req64n` is a “don't care”. For a 64-bit transaction, `lm_req64n` is asserted and `lm_req32n` is de-asserted. To minimize latency, the local master should issue the valid address, command and burst length on `l_ad_in`, `lm_cben_in[3:0]` and `lm_burst_length` respectively during the same clock cycle that `lm_req32n` or `lm_req64n` is asserted. Once PCI bus grants the bus, `lm_gntn` is asserted to indicate local master to continue with next process. Then local master works with `lm_status`. `lm_req32n` and `lm_req64n` should be deasserted right after `lm_status` is in “Address Loading” state, unless Fast Back-to-Back is intended. A normal transaction sequence of status starts from “Bus Termination” to “Address Loading” to “Bus Transaction” and ends with “Bus Termination”. During “Bus Transaction”, local master reads or writes data based on `lm_data_xfern` signal.

When the local master bus width is 64-bit, `lm_ldata_xfern` and `lm_hdata_xfern` are used instead of `lm_data_xfern`. For 32-bit data width BAR, only `lm_ldata_xfern` is used. For 64-bit data width BAR, `lm_ldata_xfern` and `lm_hdata_xfern` are used together. The signal `lm_ldata_xfern` applies to the lower 32 bits of data, `lm_hdata_xfern` applies to the upper 32 bits of data.

Basic PCI Master Read and Write Transactions

Read and write transactions to memory and I/O space are used to transfer data on the PCI bus. The basic read and write transactions use the following PCI commands:

- I/O Read
- I/O Write
- Memory Read
- Memory Write
- Configuration Read
- Configuration Write

To simplify the integration of the PCI IP core, the basic master transactions are described based on different bus configurations supported with this PCI IP core. Although the fundamentals of the basic master transactions are the same, different bus configurations require slightly different local bus signaling. Refer to the following sections for more information on the basic bus master transactions with specific PCI IP core configurations:

- 32-bit PCI Master with a 32-Bit Local Bus
- 64 bit PCI Master with a 64-Bit Local Bus
- 32-bit PCI Master with a 64-Bit Local Bus

Refer to the advanced bus master transactions in the Advanced Master Transactions section for more information on properly handling wait state insertion and early termination of bus transactions by the PCI IP core.

Waveform Legend

Symbol	Description
	Driven signal
	Driven bus signals or driven PCI parity signal (par and par64).
	Floated PCI signals. If the signal is high, it is high maintained by system pull-up resistor. If the signal is in the middle of level place, it is tri-state.
	Don't care local signal. For input signal, the core doesn't read it. For output signal, it is an invalid value.
	1. Local interface: Don't care bus signals. For input signals, the core doesn't read it. For output signal, they are invalid value. 2. PCI interface: the signal can be any value.
	PCI signal turnaround. The core releases PCI bus control and changes output enable from ENABLE to DISABLE.

Note: The clock number in the waveform is for the clock period, that is, after the current rising clock edge.

32-bit PCI Master with a 32-bit Local Bus

This section discusses read and write transactions executed by the PCI IP core operating as a master, configured with a 32-bit PCI bus and a 32-bit local bus. Because 32-bit I/O and memory transactions are alike, they are discussed together.

[Figure 2-7](#) illustrates a basic 32-bit read transaction. [Table 2-11](#) gives a clock-by-clock description of the basic 32-bit transaction shown in [Figure 2-7](#). Understanding the latency between the PCI bus and the IP core's Local Master Interface is important for a read transaction. The clock number in the waveforms is for the clock period, that is, after the current rising clock edge.

Figure 2-7. 32-bit Master Single Read Transaction with a 32-Bit Local Interface

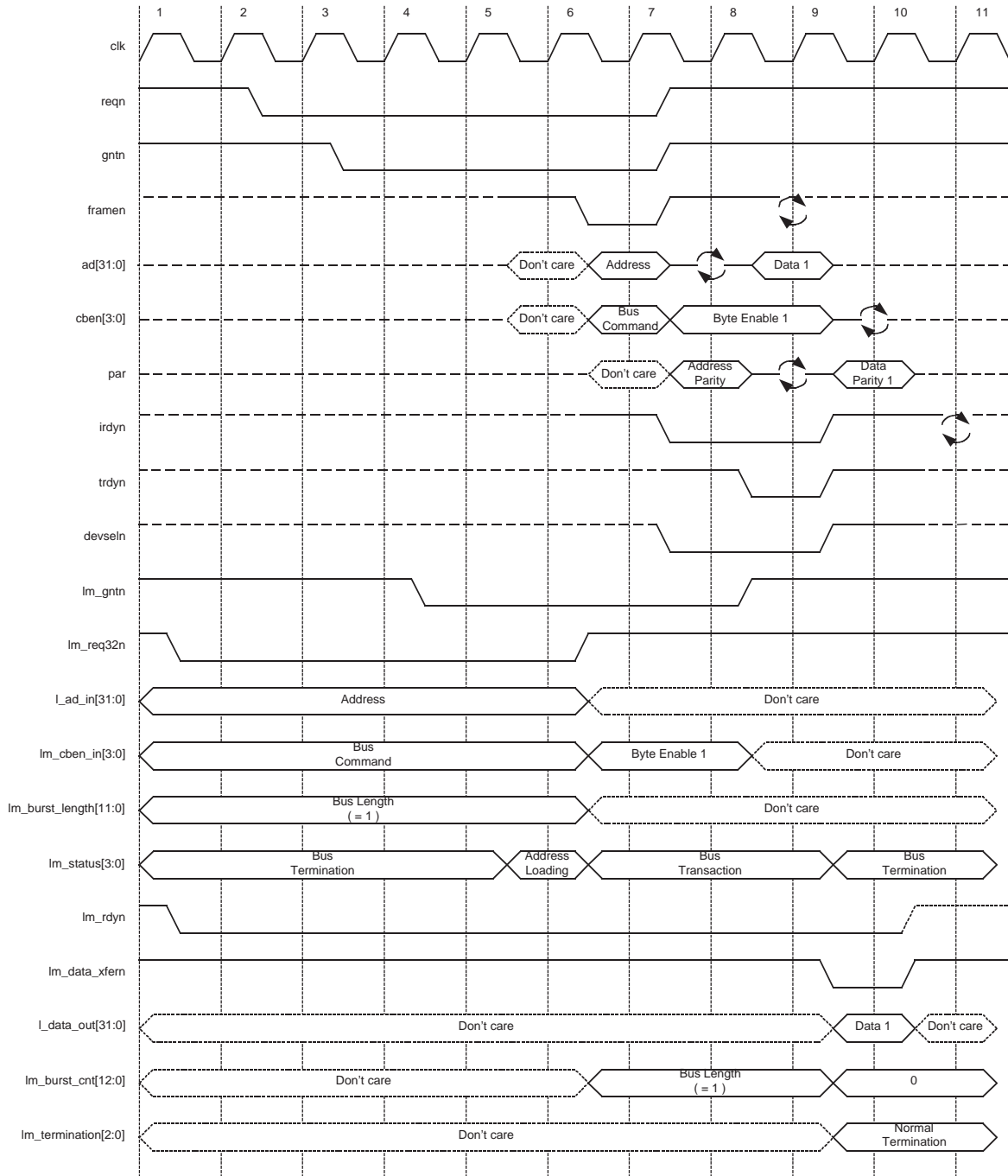

Table 2-11. 32-bit Master Single Read Transaction with a 32-Bit Local Interface

CLK	Phase	Description
1	Idle	The <code>lm_req32n</code> signal is asserted by the master application logic on the Local Master interface for the 32-bit data transaction request. The Local Master interface drives the PCI starting address, the bus command, and the burst transaction length during the same clock cycle on <code>l_ad_in</code> , <code>lm_cben_in</code> and <code>lm_burst_length</code> , respectively.
2	Idle	The Core's Local Master Interface detects the asserted <code>lm_req32n</code> and asserts <code>reqn</code> to request the use of PCI bus.
3	Idle	<code>gntn</code> is asserted to grant the Core access to the PCI bus. Core is now the PCI master.
4	Idle	Since <code>gntn</code> is asserted and the current bus is idle, the Core starts the bus transactions. The Core asserts <code>lm_gntn</code> to inform the local master that the bus request is granted.
5	Idle	If both <code>lm_req32n</code> and <code>gntn</code> were asserted on the previous cycle, <code>lm_status[3:0]</code> is changed to 'Address Loading' to indicate the starting address, the bus command, and the burst length are being latched.
6	Address	The Core asserts <code>framen</code> to start transaction and the local master de-asserts <code>lm_req32n</code> when the previous <code>lm_status[3:0]</code> was 'Address Loading' and if it doesn't want to request fast back-to-back PCI bus transaction. Since <code>lm_status[3:0]</code> was 'Address Loading' on the previous cycle. The Core drives the PCI starting address on <code>ad[31:0]</code> and the PCI command on <code>cben[3:0]</code> . On the same cycle, it outputs <code>lm_status[3:0]</code> as 'Bus Transaction' to indicate the beginning of the address/data phases. <code>lm_burst_cnt</code> gets the value of the burst length. Because <code>lm_rdyn</code> was asserted on the previous cycle and the next cycle is the first data phase, the local master provides the byte enables on <code>lm_cben_in[3:0]</code> . Asserting <code>lm_rdyn</code> also means the local master is ready to read data. If it is not ready to read data, it keeps <code>lm_rdyn</code> de-asserted until it is ready.
7	Turn around	The Core de-asserts <code>reqn</code> when <code>framen</code> was asserted and <code>lm_req32n</code> was de-asserted on the previous cycle. The Core tri-states the <code>ad[31:0]</code> lines and drives the byte enables (Byte Enable 1). Since <code>lm_rdyn</code> was asserted on the previous cycle, it asserts <code>irdyn</code> to indicate it is ready to read data. Because this is a single data phase transaction, the master de-asserts <code>framen</code> simultaneously. The target asserts <code>devseln</code> to claim the transaction.
8	Data 1	The Core de-asserts <code>lm_gntn</code> to follow <code>gntn</code> . The target asserts <code>trdyn</code> and puts Data 1 on <code>ad[31:0]</code> . If the local master is ready to read the first DWORD, <code>lm_rdyn</code> remains asserted. Since both <code>irdyn</code> and <code>trdyn</code> are asserted, the first data phase is completed on this cycle.
9	Turn around	The Core relinquishes control of <code>framen</code> and <code>cben</code> . It de-asserts <code>irdyn</code> and changes the status of <code>lm_status[3:0]</code> into 'Bus Termination' with <code>lm_termination</code> as 'Normal Termination' because both <code>trdyn</code> and <code>irdyn</code> were asserted during the last cycle. Since the previous data phase was completed, the Core transfers Data 1 on <code>l_data_out[31:0]</code> and decreases the <code>lm_burst_cnt</code> to zero. The target relinquishes control of <code>ad[31:0]</code> . It de-asserts <code>devseln</code> and <code>trdyn</code> . If both <code>trdyn</code> and <code>lm_rdyn</code> were asserted on the previous cycle, the Core asserts <code>lm_data_xfern</code> to the local master to signify Data 1 is available on <code>l_data_out[31:0]</code> . With <code>lm_data_xfern</code> asserted, the local master safely reads Data 1.
10	Idle	The master relinquishes control of <code>irdyn</code> and de-asserts <code>lm_data_xfern</code> , and the local master de-asserts <code>lm_rdyn</code> .

Figure 2-8 illustrates a basic 32-bit write transaction. Table 2-12 gives a clock-by-clock description of the 32-bit write transaction.

Figure 2-8. 32-bit Master Single Write Transaction with a 32-bit Local Interface



Table 2-12. 32-bit Master Single Write Transaction with a 32-bit Local Interface

CLK	Phase	Description
1	Idle	The <code>lm_req32n</code> signal is asserted by the master application logic on the Local Master interface for the 32-bit data transaction request. The Local Master interface drives the PCI starting address, the bus command, and the burst transaction length during the same clock cycle on <code>l_ad_in</code> , <code>lm_cben_in</code> and <code>lm_burst_length</code> , respectively.
2	Idle	The Core's Local Master Interface detects the asserted <code>lm_req32n</code> and asserts <code>reqn</code> to request the use of PCI bus.
3	Idle	<code>gntn</code> is asserted to grant the Core access to the PCI bus. Core is now the PCI master.
4	Idle	Since <code>gntn</code> is asserted and the current bus is idle, the Core is going to start the bus transactions. The Core asserts <code>lm_gntn</code> to inform the local master that the bus request is granted.
5	Idle	If both <code>lm_req32n</code> and <code>gntn</code> were asserted on the previous cycle, <code>lm_status[3:0]</code> is changed to 'Address Loading' to indicate the starting address, the bus command and the burst length are being latched.
6	Address	<p>The local master de-asserts <code>lm_req32n</code> when the previous <code>lm_status[3:0]</code> was 'Address Loading' and if it doesn't want to request another PCI bus transaction.</p> <p>The Core asserts <code>framen</code> to initiate the 32-bit write transaction when <code>gntn</code> was asserted and <code>lm_status[3:0]</code> was 'Address Loading' on the previous cycle. It also drives the PCI starting address on <code>ad[31:0]</code> and the PCI command on <code>cben[3:0]</code>. On the same cycle, it outputs <code>lm_status[3:0]</code> as 'Bus Transaction' to indicate the beginning of the address/data phases. <code>lm_burst_cnt</code> gets the value of the burst length.</p> <p>Because <code>lm_rdyn</code> was asserted on the previous cycle and the next cycle is the first data phase, the local master provides Data 1 on <code>l_ad_in[31:0]</code> and the byte enables on <code>lm_cben_in[3:0]</code>. And the Core asserts <code>lm_data_xfern</code> to the local master to signify these data and byte enables are being read and will be transferred to the PCI bus.</p> <p>Asserting <code>lm_rdyn</code> means the local master is ready to write data. If it is not, it keeps <code>lm_rdyn</code> de-asserted until it is ready.</p>
7	Wait	<p>If the target completes the fast decode and is ready to receive 32-bit data, it asserts <code>devseln</code> and <code>trdyn</code>.</p> <p>The Core de-asserts <code>reqn</code> when <code>framen</code> was asserted and <code>lm_req32n</code> was de-asserted on the previous cycle.</p> <p>With <code>lm_data_xfern</code> asserted on the previous cycle that was the address phase, the local master increments the address counter while the Core transfers Data 1 and the byte enables to <code>ad[31:0]</code> and <code>cben[3:0]</code>.</p>
8	Data 1	The Core de-asserts <code>lm_gntn</code> to follow <code>gntn</code> . Since the transaction only has one data, the Core asserts <code>irdyn</code> and de-asserts <code>framen</code> , Data 1 and the byte enables are kept on the PCI bus, the first data phase is completed.
9	Turn around	The Core relinquishes control of <code>framen</code> , <code>ad</code> and <code>cben</code> . It de-asserts <code>irdyn</code> , decreases <code>lm_burst_cnt</code> to zero and changes <code>lm_status[3:0]</code> into 'Bus Termination' with <code>lm_termination</code> as 'Normal Termination' because both <code>trdyn</code> and <code>irdyn</code> were asserted last cycle. The target de-asserts <code>devseln</code> , <code>ackn</code> and <code>trdyn</code> .
10	Idle	The Core relinquishes control of <code>irdyn</code> and <code>par</code> .

64-Bit PCI Master with a 64-Bit Local Bus

This section discusses read and write transactions for a PCI IP core configured with a 64-bit PCI bus and a 64-bit local bus. The PCI Specification requires all 64-bit PCI master devices to execute both 64-bit and 32-bit transactions. The 32-bit transactions for the 32-bit Core, described in the previous section, are similar to the 32-bit transactions for the 64-bit PCI IP core configuration.

The 64-bit memory read transaction is similar to the 32-bit memory read transaction with the exception of additional PCI signals required for 64-bit signaling. [Figure 2-9](#) and [Table 2-13](#) illustrate a basic 64-bit read transaction.

Figure 2-9. 64-bit Master Single Read Transaction with a 64-bit Local Interface



Table 2-13. 64-bit Master Single Read Transaction with a 64-bit Local Interface

CLK	Phase	Description
1	Idle	The local master asserts <code>lm_req64n</code> for the 64-bit data transaction request. It also puts the PCI starting address, the bus command, and the burst length during the same clock cycle on <code>l_ad_in</code> , <code>lm_cben_in</code> , and <code>lm_burst_length</code> , respectively.
2	Idle	The Core's Local Master Interface detects the asserted <code>lm_req64n</code> and asserts <code>reqn</code> to request the use of PCI bus.
3	Idle	<code>gntn</code> is asserted to grant the Core access to the PCI bus. Core is now the PCI master.
4	Idle	Since <code>gntn</code> is asserted and the current bus is idle, the Core is going to start the bus transactions. The master asserts <code>lm_gntn</code> to inform the local master that the bus request is granted.
5	Idle	If both <code>lm_req64n</code> and <code>lm_gntn</code> are asserted on the previous cycle, <code>lm_status[3:0]</code> is changed to 'Address Loading' to indicate the starting address, the bus command and the burst length are latched.
6	Address	<p>The local master de-asserts <code>lm_req64n</code> when the previous <code>lm_status[3:0]</code> was 'Address Loading' and if it doesn't want to request another PCI bus transaction.</p> <p>The Core asserts <code>framen</code> and <code>req64n</code> to initiate the 64-bit read transaction when <code>gntn</code> was still asserted and <code>lm_status[3:0]</code> was 'Address Loading' on the previous cycle. It also drives the PCI starting address on <code>ad[31:0]</code> and the PCI command on <code>cben[3:0]</code>. On the same cycle, it outputs <code>lm_status[3:0]</code> as 'Bus Transaction' to indicate the beginning of the address/data phases.</p> <p><code>lm_burst_cnt</code> gets the value of the burst length.</p> <p>Because <code>lm_rdyn</code> was asserted on the previous cycle and the next cycle is the first data phase, the local master provides the byte enables on <code>lm_cben_in[7:0]</code>. Asserting <code>lm_rdyn</code> also means the local master is ready to read data for the single data transaction. If it is not ready to read data, it keeps <code>lm_rdyn</code> de-asserted until it is ready.</p>
7	Turn around	The Core de-asserts <code>reqn</code> when <code>framen</code> was asserted but <code>lm_req64n</code> was de-asserted on the previous cycle. The target asserts <code>devseln</code> and <code>ack64n</code> to indicate it acknowledges the 64-bit transaction. The Core tri-states the <code>ad[63:0]</code> lines and drives the byte enables (Byte Enable 1 and 2).
8	Wait	<p>The Core asserts <code>lm_64bit_transn</code> to indicate the current data transaction is 64 bits wide. It de-asserts <code>lm_gntn</code> to follow <code>gntn</code>.</p> <p>The target asserts <code>trdyn</code> and puts Data 1 and 2 on <code>ad[63:0]</code>.</p> <p>If the local master is ready to read the 64-bit word (QWORD), it keeps <code>lm_rdyn</code> asserted.</p>
9	Data 1 and 2	Since <code>lm_rdyn</code> was asserted on the previous cycle, it asserts <code>irdyn</code> to indicate it is ready to read data. Since both <code>irdyn</code> and <code>trdyn</code> are asserted, the first data phase is completed on this cycle.
10	Turn around	<p>Since the previous data phase was completed, the Core transfers Data 1 and 2 on <code>l_data_out[63:0]</code> and decreases the <code>lm_burst_cnt</code> to zero.</p> <p>The Core relinquishes control of <code>framen</code>, <code>req64n</code> and <code>cben</code>. It de-asserts <code>irdyn</code> and changes <code>lm_status[3:0]</code> into 'Bus Termination' with <code>lm_termination</code> as 'Normal Termination' because both <code>trdyn</code> and <code>irdyn</code> were asserted last cycle.</p> <p>The target relinquishes control of <code>ad[63:0]</code>. It de-asserts <code>devseln</code>, <code>ack64n</code> and <code>trdyn</code>.</p> <p>If both <code>trdyn</code> and <code>lm_rdyn</code> were asserted on the previous cycle, the Core asserts <code>lm_ldata_xfern</code> and <code>lm_hdata_xfern</code> to the local master to signify Data 1 and 2 are available on <code>l_data_out[63:0]</code>. With <code>lm_ldata_xfern</code> and <code>lm_hdata_xfern</code> asserted, the local master safely reads Data 1 and 2.</p>
11	Idle	The Core relinquishes control of <code>irdyn</code> and de-asserts <code>lm_ldata_xfern</code> and <code>lm_hdata_xfern</code> , and the local master de-asserts <code>lm_rdyn</code> since all of the burst data have been read.

The 64-bit memory write transaction is similar to the 32-bit target write transaction with additional PCI signals required for 64-bit signaling. Figure 2-10 and Table 2-14 show a basic 64-bit write transaction.

Figure 2-10. 64-bit Master Single Write Transaction with a 64-bit Local Interface



Table 2-14. 64-bit Master Single Write Transaction with a 64-bit Local Interface

CLK	Phase	Description
1	Idle	The local master asserts <code>lm_req64n</code> for the 64-bit data transaction request. It also issues the PCI starting address, the bus command and the burst length on <code>l_ad_in</code> , <code>lm_cben_in</code> and <code>lm_burst_length</code> respectively on the same clock cycle.
2	Idle	The Core's Local Master Interface detects the asserted <code>lm_req64n</code> and asserts <code>reqn</code> to request the use of PCI bus.
3	Idle	<code>gntn</code> is asserted to grant the Core access to the PCI bus. Core is now the PCI master.
4	Idle	Since <code>gntn</code> is asserted and the current bus is idle, the Core is going to start the bus transactions. The Core asserts <code>lm_gntn</code> to inform the local master that the bus request is granted.
5	Idle	If both <code>lm_req64n</code> and <code>lm_gntn</code> were asserted on the previous cycle, <code>lm_status[3:0]</code> is changed to 'Address Loading' to indicate the starting address, the bus command and the burst length are being latched.
6	Address	<p>The local master de-asserts <code>lm_req64n</code> when the previous <code>lm_status[3:0]</code> was 'Address Loading' and if it doesn't want to request another PCI bus transaction.</p> <p>The Core asserts <code>framen</code> and <code>req64n</code> to initiate the 64-bit write transaction when <code>gntn</code> was asserted and <code>lm_status[3:0]</code> was 'Address Loading' on the previous cycle. It also drives the PCI starting address on <code>ad[31:0]</code> and the PCI command on <code>cben[3:0]</code>. On the same cycle, it outputs <code>lm_status[3:0]</code> as 'Bus Transaction' to indicate the beginning of the address/data phases.</p> <p><code>lm_burst_cnt</code> gets the value of the burst length.</p> <p>Because <code>lm_rdyn</code> was asserted on the previous cycle and the next cycle is the first data phase, the local master provides Data 1 and Data 2 on <code>l_ad_in[63:0]</code> and the byte enables on <code>lm_cben_in[7:0]</code>. And the Core asserts <code>lm_ldata_xfern</code> and <code>lm_hdata_xfern</code> to the local master to signify these data and byte enables are being read and will be transferred to the PCI bus.</p> <p>Asserting <code>lm_rdyn</code> means the local master is ready to write data. If it is not, it keeps <code>lm_rdyn</code> de-asserted until it is ready.</p>
7	Wait	<p>The Core de-asserts <code>reqn</code> when <code>framen</code> was asserted and <code>lm_req64n</code> was de-asserted on the previous cycle.</p> <p>If the target completes the fast decode and is ready to receive 64-bit data, it asserts <code>devseln</code>, <code>ack64n</code> and <code>trdyn</code>.</p> <p>With <code>lm_ldata_xfern</code> and <code>lm_hdata_xfern</code> asserted on the previous cycle that was the address phase, the local master increments the address counter while the Core transfers Data 1 and Data 2 and their byte enables to <code>ad[63:0]</code> and <code>cben[7:0]</code>.</p> <p>Because this is the first write data phase and <code>devseln</code> is just asserted, the master keeps <code>framen</code> asserted and <code>irdyn</code> de-asserted to judge 64-bit or 32-bit transaction.</p>
8	Wait	Since <code>ack64n</code> and <code>trdyn</code> are asserted on the previous cycle. The Core asserts <code>lm_64bit_transn</code> to indicate the current data transaction is 64-bits wide. It de-asserts <code>lm_gntn</code> to follow <code>gntn</code> .
9	Data 1 and 2	With <code>lm_rdyn</code> asserted in the previous cycle, the Core asserts <code>irdyn</code> and deasserts <code>framen</code> for a single cycle transaction. Since both <code>irdyn</code> and <code>trdyn</code> are asserted, the data phase is completed on the cycle.
10	Turn around	The Core relinquishes control of <code>framen</code> , <code>req64n</code> , <code>ad</code> and <code>cben</code> . It de-asserts <code>irdyn</code> , decreases ' <code>lm_burst_cnt</code> ' to zero and changes <code>lm_status[3:0]</code> into 'Bus Termination' with <code>lm_termination</code> as 'Normal Termination' because both <code>trdyn</code> and <code>irdyn</code> were asserted last cycle. The target de-asserts <code>devseln</code> , <code>ack64n</code> and <code>trdyn</code> .
11	Idle	The Core relinquishes control of <code>irdyn</code> , <code>par</code> and <code>par64</code> .

32-bit PCI Master with a 64-Bit Local Bus

This section discusses read and write transactions executed by the PCI IP core configured with a 32-bit PCI bus and a 64-bit local bus. The 32-bit PCI master transactions, described in the 32-Bit PCI Master and 32-Bit Local Bus section, are similar to these master transactions; however, the data is handled differently at the Local Master Interface. Two 32-bit PCI data phases are required to transfer 64 bits of data to the Local Master Interface.

The Local Master Interface control latches the complete QWORD and routes the proper DWORD to the PCI data bus. The `lm_ldata_xfern` and `lm_hdata_xfern` signals specify which DWORD is transferred.

If the starting address is aligned with QWORD, the first DWORD is assumed to be the lower DWORD of a QWORD and is placed on the PCI data bus. Otherwise, the upper DWORD is placed on the PCI data bus.

The 64-bit memory read transaction is similar to the 32-bit target read transaction with additional PCI signals required for 64-bit signaling. [Figure 2-11](#) and [Table 2-15](#) illustrate a basic 64-bit read transaction.

Figure 2-11. 32-bit Master Single Read Transaction with a 64-bit Local Interface



Table 2-15. 32-bit Master Single Read Transaction with a 64-bit Local Interface

CLK	Phase	Description
1	Idle	The local master asserts <code>lm_req64n</code> for the 64-bit data transaction request. It also issues the PCI starting address, the bus command and the burst length on <code>l_ad_in</code> , <code>lm_cben_in</code> and <code>lm_burst_length</code> respectively on the same clock cycle.
2	Idle	The Core's Local Master Interface detects the asserted <code>lm_req64n</code> and asserts <code>reqn</code> to request the use of PCI bus.
3	Idle	<code>gntn</code> is asserted to grant the Core access to the PCI bus. Core is now the PCI master.
4	Idle	Since <code>gntn</code> is asserted and the current bus is idle, the Core is going to start the bus transactions. The Core asserts <code>lm_gntn</code> to inform the local master that the bus request is granted.
5	Idle	If both <code>lm_req64n</code> and <code>lm_gntn</code> were asserted on the previous cycle, <code>lm_status[3:0]</code> is changed to 'Address Loading' to indicate the starting address, the bus command and the burst length are being latched.
6	Address	<p>The local master de-asserts <code>lm_req64n</code> when the previous <code>lm_status[3:0]</code> was 'Address Loading' and if it doesn't want to request another PCI bus transaction.</p> <p>The Core asserts <code>framen</code> and <code>req64n</code> initiate the 64-bit read transaction when <code>gntn</code> was still asserted and <code>lm_status[3:0]</code> was 'Address Loading' on the previous cycle. It also drives the PCI starting address on <code>ad[31:0]</code> and the PCI command on <code>cben[3:0]</code>. On the same cycle, it outputs <code>lm_status[3:0]</code> as 'Bus Transaction' to indicate the beginning of the address/data phases.</p> <p><code>lm_burst_cnt</code> gets the value of the burst length.</p> <p>Because <code>lm_rdyn</code> was asserted on the previous cycle and the next cycle is the first data phase, the local master provides the byte enables on <code>lm_cben_in[7:0]</code>. Asserting <code>lm_rdyn</code> also means the local master is ready to read data. If it is not ready to read data, it keeps <code>lm_rdyn</code> de-asserted until it is ready.</p>
7	Turn around	<p>The Core de-asserts <code>reqn</code> when <code>framen</code> was asserted but <code>lm_req64n</code> was de-asserted on the previous cycle.</p> <p>The Core tri-states the <code>ad[63:0]</code> lines and drives the byte enables (Byte Enable 1 and 2). Since <code>lm_rdyn</code> was asserted on the previous cycle, it asserts <code>irdyn</code> to indicate it is ready to read data. The target asserts <code>devseln</code>. Since the target is 32 bits, it doesn't assert <code>ack64n</code> as <code>devseln</code>.</p>
8	Wait	<p>The Core de-asserts <code>lm_gntn</code> to follow <code>gntn</code>. The target asserts <code>trdyn</code> and puts Data 1 <code>ad[31:0]</code>.</p> <p>Since the Core detects the PCI bus transaction is 32 bits, it de-asserts <code>lm_64bit_transn</code> and changes <code>lm_burst_cnt</code> to two. The transaction is changed from single cycle to burst cycle.</p> <p>If the local master is ready to read the first DWORD, it keeps <code>lm_rdyn</code> asserted.</p>
9	Data 1	The Core asserts <code>irdyn</code> and keeps <code>framen</code> asserted to signify the burst continues. Since both <code>irdyn</code> and <code>trdyn</code> are asserted, the first data phase is completed on this cycle.
10	Data 2	<p>Since the previous data phase was completed, the Core transfers Data 1 on <code>l_data_out[31:0]</code> and decreases the <code>lm_burst_cnt</code> to one.</p> <p>If both <code>trdyn</code> and <code>lm_rdyn</code> were asserted on the previous cycle, the Core asserts <code>lm_ldata_xfern</code> to the local master to signify Data is available on <code>l_data_out[31:0]</code>. With <code>lm_ldata_xfern</code> asserted, the local master can safely read Data 1 and increment the address counter.</p> <p>If the local master keeps <code>lm_rdyn</code> asserted on the previous cycle, the Core keeps <code>irdyn</code> asserted.</p> <p>If the target is still ready to provide data, it keeps <code>trdyn</code> asserted and drives the next DWORD (Data 2) on <code>ad[31:0]</code>.</p> <p>If the local master is ready to read the next DWORD, it keeps <code>lm_rdyn</code> asserted.</p> <p>The Core keeps <code>irdyn</code> and de-asserts <code>framen</code> for the last data cycle.</p> <p>Since both <code>irdyn</code> and <code>trdyn</code> are asserted, the second data phase is completed on this cycle.</p>

Table 2-15. 32-bit Master Single Read Transaction with a 64-bit Local Interface (Continued)

CLK	Phase	Description
11	Turn around	<p>Since the previous data phase was completed, the Core transfers Data 2 on <code>l_data_out[63:32]</code> and decreases the <code>lm_burst_cnt</code> to zero.</p> <p>The Core relinquishes control of <code>framen</code>, <code>req64n</code> and <code>cben</code>. It de-asserts <code>irdyn</code> and changes <code>lm_status[3:0]</code> into 'Bus Termination' with <code>lm_termination</code> as 'Normal Termination' because both <code>trdyn</code> and <code>irdyn</code> were asserted last cycle.</p> <p>The target relinquishes control of <code>ad[31:0]</code>. It de-asserts <code>devseln</code> and <code>trdyn</code>.</p> <p>If both <code>trdyn</code> and <code>lm_rdyn</code> were asserted on the previous cycle, the Core asserts <code>lm_hdata_xfern</code> to the local master to signify Data 2 is available on <code>l_data_out[63:32]</code>. With <code>lm_hdata_xfern</code> asserted, the local master can safely read Data 2.</p>
12	Idle	The Core relinquishes control of <code>irdyn</code> and de-asserts <code>lm_hdata_xfern</code> , and the local master de-asserts <code>lm_rdyn</code> since all of the burst data have been read.

The 64-bit memory write transaction is similar to the 32-bit write transaction with additional PCI signals required for 64-bit signaling. [Figure 2-12](#) and [Table 2-16](#) show a basic 64-bit write transaction.

Figure 2-12. 32-bit Master Single Write Transaction with a 64-bit Local Interface



Table 2-16. 32-bit Master Single Write Transaction with a 64-bit Local Interface

CLK	Phase	Description
1	Idle	The local master asserts <code>lm_req64n</code> for the master 64-bit data transaction request. It also issues the PCI starting address, the bus command and the burst length on <code>l_ad_in</code> , <code>lm_cben_in</code> and <code>lm_burst_length</code> respectively on the same clock cycle.
2	Idle	The Core's Local Master Interface detects the asserted <code>lm_req64n</code> and asserts <code>reqn</code> to request the use of PCI bus.
3	Idle	<code>gntn</code> is asserted to grant the Core access to the PCI bus. Core is now the PCI master.
4	Idle	Since <code>gntn</code> is asserted and the current bus is idle, the Core is going to start the bus transactions. The Core asserts <code>lm_gntn</code> to inform the local master that the bus request is granted.
5	Idle	If both <code>lm_req64n</code> and <code>gntn</code> were asserted on the previous cycle, <code>lm_status[3:0]</code> is changed to 'Address Loading' to indicate the starting address, the bus command and the burst length are being latched.
6	Address	<p>The local master de-asserts <code>lm_req64n</code> when the previous <code>lm_status[3:0]</code> was 'Address Loading' and if it doesn't want to request another PCI bus transaction.</p> <p>The Core asserts <code>framen</code> and <code>req64n</code> to initiate the 64-bit write transaction when <code>gntn</code> was asserted and <code>lm_status[3:0]</code> was 'Address Loading' on the previous cycle. It also drives the PCI starting address on <code>ad[31:0]</code> and the PCI command on <code>cben[3:0]</code>. On the same cycle, it outputs <code>lm_status[3:0]</code> as 'Bus Transaction' to indicate the beginning of the address/data phases.</p> <p><code>lm_burst_cnt</code> gets the value of the burst length.</p> <p>Because <code>lm_rdyn</code> was asserted on the previous cycle and the next cycle is the first data phase, the local master should provide Data 1 and Data 2 on <code>l_ad_in[63:0]</code> and the byte enables on <code>lm_cben_in[7:0]</code>. The Core asserts <code>lm_ldata_xfern</code> and <code>lm_hdata_xfern</code> to the local master to signify these data and byte enables are being read and will be transferred to the PCI bus.</p> <p>Asserting <code>lm_rdyn</code> means the local master is ready to write data. If it is not, it should keep <code>lm_rdyn</code> de-asserted until it is ready.</p>
7	Wait	<p>If the target completes the fast decode and is ready to receive 32-bit data, it asserts <code>devseln</code> and <code>trdyn</code>. But it doesn't assert <code>ack64n</code>.</p> <p>The Core de-asserts <code>reqn</code> when <code>framen</code> was asserted and <code>lm_req64n</code> was de-asserted on the previous cycle.</p> <p>With <code>lm_ldata_xfern</code> and <code>lm_hdata_xfern</code> asserted on the previous cycle that was the address phase, the Core transfers Data 1, Data 2 and the byte enables to <code>ad[63:0]</code> and <code>cben[7:0]</code>.</p>
8	Wait	The Core de-asserts <code>lm_gntn</code> to follow <code>gntn</code> . Since the Core detects the PCI bus transaction width is 32 bits. It de-asserts <code>lm_64bit_transn</code> and changes <code>lm_burst_cnt</code> to two. The transaction is changed from a single cycle to a burst cycle.
9	Data 1	<p>With both <code>devseln</code> and <code>lm_rdyn</code> asserted previous cycle, the Core asserts <code>irdyn</code>, and it prepares for the 32-bit write burst.</p> <p>Because the Core performs the burst transactions, it keeps <code>framen</code> asserted.</p> <p>Since both <code>irdyn</code> and <code>trdyn</code> are asserted, the first data phase is completed on this cycle.</p>
10	Data 2	<p>Since the previous data phase was completed, the Core decreases <code>lm_burst_cnt</code>.</p> <p>Since Data 1 PCI bus was read by the target, the Core transfers Data 2 and the byte enables to <code>ad[31:0]</code> and <code>cben[3:0]</code>.</p> <p>With <code>lm_rdyn</code> asserted previous cycle, the Core keeps <code>irdyn</code> asserted. The Core de-asserts <code>framen</code> for the last data cycle.</p> <p>Since both <code>irdyn</code> and <code>trdyn</code> are asserted, the second data phase is completed on this cycle.</p>
11	Turn around	The Core relinquishes control of <code>framen</code> , <code>req64n</code> , <code>ad</code> and <code>cben</code> . It de-asserts <code>irdyn</code> , decreases <code>lm_burst_cnt</code> to zero and changes <code>lm_status[3:0]</code> into 'Bus Termination' with <code>lm_termination</code> as 'Normal Termination' because both <code>trdyn</code> and <code>irdyn</code> were asserted last cycle. The target de-asserts <code>devseln</code> and <code>trdyn</code> .
10	Idle	The Core relinquishes control of <code>irdyn</code> <code>par</code> and <code>par64</code> .

Configuration Read and Write Transactions

When operating as a PCI master, the PCI IP core supports Configuration cycles to CSR addresses 00h to FFh. The Local Master Interface has full control of these types of accesses, which are similar to the memory transactions described in earlier sections. The PCI IP core only supports 32-bit, single data phase transactions to the configuration registers.

During a configuration access, the PCI master drives an address/data pin that is connected to the `idsel` signal for all of the PCI target devices. For more information on the binding of the address/data signals to the `idsel` signal, refer to the *PCI Local Bus Specification, Revision 3.0*.

PCI Master I/O Read and Write Transactions

The PCI IP core's application executes I/O space transactions. Transactions to I/O address space are similar to the basic memory transactions discussed in the Basic PCI Master Read and Write Transactions section.

By definition, read and write transactions to I/O space are executed using 32-bit PCI transactions only. Driving all 32 bits of the address and byte enables (`cben [3 : 0]`) is required.

Advanced Master Transactions

Most PCI applications require more than basic read and write transactions. For these applications, the PCI IP core offers advanced features to handle the more difficult aspects of the PCI bus. The advanced features are used to provide the PCI application with more flexibility and improve the overall PCI system performance.

Wait States

Care must be taken when processing wait states to be compliant with the *PCI Local Bus Specification, Revision 3.0*. Once a PCI master or a PCI target signals that it is ready to send or receive data, it must complete the current PCI data phase. For example, if the PCI IP core, as a target, is ready to write data and the PCI master inserts wait states, the PCI IP core must wait to write the data until the master is ready again. Additionally, if the PCI IP core asserts `trdyn` for a data phase, it cannot insert any wait states until the next data phase. Coincident master and target wait state insertion is also a possibility. Refer to the PCI Specification for more information regarding coincident wait state insertion.

Two types of wait states occur on the PCI bus: master wait state insertion and target wait state insertion. When the PCI master inserts wait states, the PCI IP core must hold off data until the PCI master is ready to complete the data phase. The PCI IP core inserts the second type of wait states. The back-end application controls the PCI IP core's wait state insertion via the Local Master Interface.

[Figure 2-13](#) and [Table 2-17](#) illustrate master-inserted and target-inserted wait states for read transactions. The figure illustrates the correlation between the PCI Interface and the Local Master Interface. The table gives a clock-by-clock description of each event in the figure.

Figure 2-13. 32-bit Master Read Transaction with Local Wait State



Table 2-17. 32-bit Master Read Transaction with Local Wait State

CLK	PCI Data Phase	Description
1	Idle	The <code>lm_req32n</code> signal is asserted on the Local Master interface, by the local master to request a 32-bit data transaction. The local master issues the PCI starting address, the bus command and the burst length during the same clock cycle, to <code>l_ad_in</code> , <code>lm_cben_in</code> , and <code>lm_burst_length</code> , respectively.
2	Idle	The master detects the asserted <code>lm_req32n</code> and asserts <code>reqn</code> to request the use of PCI bus.
3	Idle	<code>gntn</code> is asserted to grant the Core access to the PCI bus. Core is now the PCI master.
4	Idle	Since <code>gntn</code> is asserted and the current bus is idle, the Core starts the bus transactions. The Core asserts <code>lm_gntn</code> to inform the local master that the bus request is granted.
5	Idle	If both <code>lm_req32n</code> and <code>gntn</code> were asserted on the previous cycle, <code>lm_status [3:0]</code> is changed to 'Address Loading' to indicate the starting address, the bus command, and the burst length are being latched.

Table 2-17. 32-bit Master Read Transaction with Local Wait State (Continued)

CLK	PCI Data Phase	Description
6	Address	<p>The Core asserts <code>framen</code> to start transaction and the local master de-asserts <code>lm_req32n</code> when the previous <code>lm_status[3:0]</code> was 'Address Loading' and if it doesn't want to request another PCI bus transaction.</p> <p><code>lm_status[3:0]</code> was 'Address Loading' on the previous cycle. It also drives the PCI starting address on <code>ad[31:0]</code> and the PCI command on <code>cben[3:0]</code>. On the same cycle, it outputs <code>lm_status[3:0]</code> as 'Bus Transaction' to indicate the beginning of the address/data phases. <code>lm_burst_cnt</code> gets the value of the burst length.</p> <p>Because <code>lm_rdyn</code> was asserted on the previous cycle and the next cycle is the first data phase, the local master provides the byte enables on <code>lm_cben_in[3:0]</code>. Asserting <code>lm_rdyn</code> also means the local master is ready to read data. If it is not ready to read data, it keep <code>lm_rdyn</code> de-asserted until it is ready.</p>
7	Turn around	<p>The Core de-asserts <code>reqn</code> when <code>framen</code> was asserted and <code>lm_req32n</code> was de-asserted on the previous cycle.</p> <p>The Core tri-states the <code>ad[31:0]</code> lines and drives the byte enables (Byte Enable 1). Since <code>lm_rdyn</code> was asserted on the previous cycle, it asserts <code>irdyn</code> to indicate it is ready to read data. Because this is not the last cycle transaction, the Core keeps <code>framen</code>.</p> <p>The target asserts <code>devseln</code> to response the command.</p>
8	Data 1	<p>The Core de-asserts <code>lm_gntn</code> to follow <code>gntn</code>.</p> <p>With the <code>trdyn</code> asserted, Data 1 is driven on to <code>ad[31:0]</code>. If the PCI IP core is ready to receive data, <code>irdyn</code> remains asserted and it keeps the Byte Enables on <code>cben[3:0]</code>.</p> <p>The Local Master interface is ready to receive data, so it keeps <code>lm_rdyn</code>.</p>
9	Data 2	<p>If the PCI IP core is ready to receive data, it asserts <code>irdyn</code> and keeps the byte enables on <code>cben[3:0]</code>. The target device drives Data 2 on the PCI bus.</p> <p>Since the previous data phase was completed, the master transfers Data 1 on <code>l_data_out[31:0]</code> and decreases <code>lm_burst_cnt</code> to two. The Core asserts <code>lm_data_xfern</code> if <code>lm_rdyn</code> was asserted on the previous cycle.</p> <p>The local master interface is not ready to receive next data, so it de-asserts <code>lm_rdyn</code>.</p>
10	Master Wait	<p>Since <code>lm_rdyn</code> was de-asserted on the previous cycle, the Core de-asserts <code>irdyn</code> to signify the Core is inserting a wait state. The target device drives Data 3 on the PCI bus.</p> <p>Since the previous data phase was completed, the Core transfers Data 2 on <code>l_data_out[31:0]</code> and decreases <code>lm_burst_cnt</code> to one. The Core de-asserts <code>lm_data_xfern</code> if <code>lm_rdyn</code> wasn't asserted on the previous cycle.</p> <p>The local master asserts <code>lm_rdyn</code> for being ready to receive data.</p>
11	Data 3	<p>The Core asserts <code>irdyn</code> and de-asserts <code>framen</code> for the last data phase. The target keeps <code>devseln</code>, <code>trdyn</code> and Data 3 on PCI bus. The Core asserts <code>lm_data_xfern</code> if <code>lm_rdyn</code> was asserted on the previous cycle. The local master asserts <code>lm_rdyn</code> for being ready to receive data.</p>
12	Turn around	<p>The Core de-asserts <code>idyn</code>, the target de-asserts both <code>devseln</code> and <code>trdyn</code>. The Core relinquishes control of <code>framen</code>, <code>ad[31:0]</code>, and <code>cben[3:0]</code>. Since the previous data phase was completed, the Core transfers Data 1 on <code>l_data_out[31:0]</code> and decreases <code>lm_burst_cnt</code> to zero. The Core asserts <code>lm_data_xfern</code> if <code>lm_rdyn</code> was asserted on the previous cycle.</p> <p>The Core changes <code>lm_status[3:0]</code> into the 'Bus Termination' state with <code>lm_termination</code> as 'Normal Termination' because both <code>trdyn</code> and <code>irdyn</code> were asserted last cycle.</p>
13	Idle	<p>The Core relinquishes control of <code>irdyn</code>.</p>

Figure 2-14 and Table 2-18 show master-inserted and target-inserted wait states occurring on write transactions. The figure illustrates the correlation of the PCI interface to the Local Master Interface. The table gives a clock-by-clock description of each event in the figure.

Figure 2-14. 32-bit Master Write Transaction with Local Wait State



Table 2-18. 32-bit Master Write Transaction with Local Wait State

CLK	PCI Data Phase	Description
1	Idle	The <code>lm_req32n</code> signal is asserted on the Local Master interface by the local master to request for 32-bit data transaction. The local master issues the PCI starting address, the bus command, and the burst length during the same clock cycle on <code>l_ad_in</code> , <code>lm_cben_in</code> and <code>lm_burst_length</code> , respectively.
2	Idle	The Core's Local Master Interface detects the asserted <code>lm_req32n</code> and asserts <code>reqn</code> to request the use of PCI bus.
3	Idle	<code>gntn</code> is asserted to grant the Core access to the PCI bus. Core is now the PCI master.
4	Idle	Since <code>gntn</code> is asserted and the current bus is idle, the Core is going to start the bus transactions. The Core asserts <code>lm_gntn</code> to inform the local master that the bus request is granted.

Table 2-18. 32-bit Master Write Transaction with Local Wait State (Continued)

CLK	PCI Data Phase	Description
5	Idle	If both <code>lm_req32n</code> and <code>gntn</code> were asserted on the previous cycle, <code>lm_status[3:0]</code> is changed to 'Address Loading' to indicate the starting address, the bus command and the burst length are being latched.
6	Address	<p>The local master de-asserts <code>lm_req32n</code> when the previous <code>lm_status[3:0]</code> was 'Address Loading' and if it doesn't want to request another PCI bus transaction.</p> <p>The Core asserts <code>framen</code> to initiate the 32-bit write transaction when <code>gntn</code> was asserted and <code>lm_status[3:0]</code> was 'Address Loading' on the previous cycle. It also drives the PCI starting address on <code>ad[31:0]</code> and the PCI command on <code>cben[3:0]</code>. On the same cycle, it outputs <code>lm_status[3:0]</code> as 'Bus Transaction' to indicate the beginning of the address/data phases.</p> <p><code>lm_burst_cnt</code> gets the value of the burst length.</p> <p>Because <code>lm_rdyn</code> was asserted on the previous cycle, the local master provides Data 1 on <code>l_ad_in[31:0]</code> and byte enable 1 on <code>lm_cben_in[3:0]</code>. And the Core asserts <code>lm_data_xfern</code> to the local master to signify these data and byte enables are being read and will be transferred to the PCI bus.</p> <p>Asserting <code>lm_rdyn</code> means the local master is ready to write data. If it is not, it keeps <code>lm_rdyn</code> de-asserted until it is ready.</p>
7	Wait	<p>If the target completes the fast decode and is ready to receive 32-bit data, it asserts <code>devseln</code> and <code>trdyn</code>.</p> <p>The Core de-asserts <code>reqn</code> when <code>framen</code> was asserted and <code>lm_req32n</code> was de-asserted on the previous cycle.</p> <p>With <code>lm_data_xfern</code> asserted on the previous cycle that was the address phase, the local master increments the address counter while the Core transfers Data 1 and the byte enables to <code>ad[31:0]</code> and <code>cben[3:0]</code>.</p> <p>Because <code>lm_rdyn</code> was asserted on the previous cycle, the local master provides Data 2 on <code>l_ad_in[31:0]</code> and byte enable 2 on <code>lm_cben_in[3:0]</code>. And the Core asserts <code>lm_data_xfern</code> to the local master to signify these data and byte enables are being read and will be transferred to the PCI bus. Data 2 will be buffered and put on PCI bus after Data 1 phase finished.</p> <p>The local master de-asserts <code>lm_rdyn</code> to inform the Core it isn't ready for Data 3.</p>
8	Data 1	The Core de-asserts <code>lm_gntn</code> to follow <code>gntn</code> . It asserts <code>irdyn</code> . <code>framen</code> , Data 1 and the byte enable 1 are kept on the PCI bus. Since the <code>irdyn</code> and <code>trdyn</code> are asserted, the first data phase is completed. The Core de-asserts <code>lm_data_xfern</code> if <code>lm_rdyn</code> was de-asserted on the previous cycle.
9	Data 2	<p>The Core asserts <code>irdyn</code> if it has gotten Data 2 from local master interface. It transfers Data 2 and byte enable 2 on <code>ad[31:0]</code> and <code>cben[3:0]</code> respectively.</p> <p>The target keeps <code>devseln</code> and <code>trdyn</code>. Data 2 phase is completed.</p> <p>Since the previous data phase was completed, the Core decreases <code>lm_burst_cnt</code> to two.</p> <p><code>lm_rdyn</code> is asserted to ready for Data3.</p>
10	Wait	<p>Since the Core has not gotten Data 3 from local master interface. It de-asserts <code>irdyn</code> to inform a wait cycle.</p> <p>Because <code>lm_rdyn</code> was asserted on the previous cycle, the local master provides Data 3 on <code>l_ad_in[31:0]</code> and byte enable 3 on <code>lm_cben_in[3:0]</code>. And the Core asserts <code>lm_data_xfern</code> to local master to signify these data and byte enables are being read and will be transferred to the PCI bus.</p> <p>Since the previous data phase was completed, the Core decreases <code>lm_burst_cnt</code> to one.</p>
11	data 3	The Core asserts <code>irdyn</code> and de-asserts <code>framen</code> to inform the last data phase. It transfer Data 3 and byte enable The third data phase is completed.
12	Turn around	The Core relinquishes control of <code>framen</code> , <code>ad</code> and <code>cben</code> . It de-asserts <code>irdyn</code> , decreases <code>lm_burst_cnt</code> to zero and changes <code>lm_status[3:0]</code> into 'Bus Termination' with <code>lm_termination</code> as 'Normal Termination' because both <code>trdyn</code> and <code>irdyn</code> were asserted last cycle.
13	Idle	The Core relinquishes control of <code>irdyn</code> , <code>par</code> .

Burst Read and Write Master Transactions

Burst read and write transactions to memory addresses are used to achieve the high throughput associated with the PCI bus. The PCI IP core supports the zero-wait state and burst data transfers for the following commands:

- Memory Read
- Memory Write
- Memory Read Multiple
- Dual Address Cycle
- Memory Read Line
- Memory Write and Invalidate

The burst data transfers are described based on the different PCI and Local bus configurations supported by the PCI IP core. Although the fundamentals of burst data transfers are similar for all PCI IP core configurations, different bus configurations require slightly different Local Master Interface signaling. The PCI IP core does not execute burst cycles for Configuration Space or I/O space accesses. Refer to the following sections for more information on bursting with specific PCI IP core configurations:

- 32-Bit PCI Master and a 32-Bit Local Bus
- 64-Bit PCI Master with a 64-Bit Local Bus
- 32-Bit PCI Master with a 64-Bit Local Bus

32-Bit PCI Master and a 32-bit Local Bus

The following section discusses read and write burst data transfers for a PCI IP core configured with a 32-bit PCI bus and a 32-bit Local bus. [Figure 2-15](#) and [Table 2-19](#) show a 32-bit burst data transfer during a read transaction. The figure illustrates how the PCI interface correlates to the Local Master Interface. The table gives a clock-by-clock description of each event that occurs in the figure.

Figure 2-15. 32-bit Master Burst Read Transaction with a 32-bit Local Interface



Table 2-19. 32-bit Master Burst Read Transaction with a 32-bit Local Interface

CLK	Phase	Description
1	Idle	The <code>lm_req32n</code> signal is asserted by the local master to request a 32-bit data transaction. The local master issues the PCI starting address, the bus command, and the burst length during the same clock cycle to <code>l_ad_in</code> , <code>lm_cben_in</code> , and <code>lm_burst_length</code> , respectively.
2	Idle	The Core's Local Master Interface detects the asserted <code>lm_req32n</code> and asserts <code>reqn</code> to request the use of PCI bus.
3	Idle	<code>gntn</code> is asserted to grant the Core access to the PCI bus. Core is now the PCI master.
4	Idle	Since <code>gntn</code> is asserted and the current bus is idle, the Core starts the bus transactions. The master asserts <code>lm_gntn</code> to inform the local master that the bus request is granted.
5	Idle	If both <code>lm_req32n</code> and <code>gntn</code> were asserted on the previous cycle, <code>lm_status[3:0]</code> is changed to 'Address Loading' to indicate the starting address, the bus command, and the burst length are being latched.

Table 2-19. 32-bit Master Burst Read Transaction with a 32-bit Local Interface (Continued)

CLK	Phase	Description
6	Address	<p>The Core asserts <code>framen</code> to start transaction and the local master de-asserts <code>lm_req32n</code> when the previous <code>lm_status[3:0]</code> was 'Address Loading' and if it doesn't want to request another PCI bus transaction.</p> <p><code>lm_status[3:0]</code> was 'Address Loading' on the previous cycle. It also drives the PCI starting address on <code>ad[31:0]</code> and the PCI command on <code>cben[3:0]</code>. On the same cycle, it outputs <code>lm_status[3:0]</code> as 'Bus Transaction' to indicate the beginning of the address/data phases.</p> <p><code>lm_burst_cnt</code> gets the value of the burst length.</p> <p>Because <code>lm_rdyn</code> was asserted on the previous cycle and the next cycle is the first data phase, the local master provides the byte enables on <code>lm_cben_in[3:0]</code>. Asserting <code>lm_rdyn</code> also means the local master is ready to read data. If it is not ready to read data, it keeps <code>lm_rdyn</code> de-asserted until it is ready.</p>
7	Turn around	<p>The Core de-asserts <code>reqn</code> when <code>framen</code> was asserted but <code>lm_req32n</code> was de-asserted on the previous cycle.</p> <p>The Core tri-states the <code>ad[31:0]</code> lines and drives the byte enables (Byte Enable 1). Since <code>lm_rdyn</code> was asserted on the previous cycle, it asserts <code>irdyn</code> to indicate it is ready to read data. Because the Core performs the burst transactions, it keeps <code>framen</code> asserted.</p>
8	Data 1	<p>It de-asserts <code>lm_gntn</code> to follow <code>gntn</code>.</p> <p>The target asserts <code>trdyn</code> and puts Data 1 on <code>ad[31:0]</code>.</p> <p>With <code>lm_rdyn</code> asserted on the previous cycle, the Core keeps <code>irdyn</code> asserted.</p> <p>The Core keeps <code>framen</code> asserted to the target to signify the burst continues.</p> <p>If the local master is ready to read the first DWORD, it keeps <code>lm_rdyn</code> asserted.</p> <p>Since both <code>irdyn</code> and <code>trdyn</code> are asserted, the first data phase is completed on this cycle.</p>
9	Data 2	<p>Since the previous data phase was completed, the Core transfers Data 2 on <code>l_data_out[31:0]</code> and decreases the <code>lm_burst_cnt</code>.</p> <p>If both <code>trdyn</code> and <code>lm_rdyn</code> were asserted on the previous cycle, the Core asserts <code>lm_data_xfern</code> the local master to signify Data 1 are available on <code>l_data_out[31:0]</code>. With <code>lm_data_xfern</code> asserted, the local master can safely read Data 1 and increment the address counter.</p> <p>If the local master keeps <code>lm_rdyn</code> asserted on the previous cycle, the Core keeps <code>irdyn</code> asserted.</p> <p>The Core keeps <code>framen</code> asserted to the target to signify the burst continues.</p> <p>If the target is still ready to provide data, it keeps <code>trdyn</code> asserted and drives the next DWORD (Data 2) on <code>ad[31:0]</code>.</p> <p>If the local master is ready to read the next DWORD, it keeps <code>lm_rdyn</code> asserted.</p> <p>Since both <code>irdyn</code> and <code>trdyn</code> are asserted, the second data phase is completed on this cycle.</p>
10	Data 3	<p>Since the previous data phase was completed, the Core transfers Data 3 on <code>l_data_out[31:0]</code> and decreases the <code>lm_burst_cnt</code>.</p> <p>If both <code>trdyn</code> and <code>lm_rdyn</code> were asserted on the previous cycle, the Core asserts <code>lm_data_xfern</code> to the local master to signify Data 2 are available on <code>l_data_out[31:0]</code>. With <code>lm_data_xfern</code> asserted, the local master can safely read Data 2 and increment the address counter.</p> <p>With <code>lm_rdyn</code> asserted on the previous cycle, the Core keeps <code>irdyn</code> asserted.</p> <p>Because the current transaction is the last, the master de-asserts <code>framen</code> to signal the end of the burst.</p> <p>If the target is still ready to provide data, it keeps <code>trdyn</code> asserted and drives the next DWORD (Data 3) on <code>ad[31:0]</code>. If the local master is ready to read the next DWORD, it keeps <code>lm_rdyn</code> asserted.</p> <p>Since both <code>irdyn</code> and <code>trdyn</code> are asserted, the third data phase is completed on this cycle.</p>

Table 2-19. 32-bit Master Burst Read Transaction with a 32-bit Local Interface (Continued)

CLK	Phase	Description
11	Turn around	<p>Since the previous data phase was completed, the Core transfers Data 3 on <code>l_data_out[31:0]</code> and decreases the <code>lm_burst_cnt</code> to zero.</p> <p>The Core relinquishes control of <code>framen</code> and <code>cben</code>. It de-asserts <code>irdyn</code> and changes <code>lm_status[3:0]</code> into 'Bus Termination' with <code>lm_termination</code> as 'Normal Termination' because both <code>trdyn</code> and <code>irdyn</code> were asserted last cycle.</p> <p>The target relinquishes control of <code>ad[31:0]</code>. It de-asserts <code>devseln</code> and <code>trdyn</code>.</p> <p>If both <code>trdyn</code> and <code>lm_rdyn</code> were asserted on the previous cycle, the Core asserts <code>lm_data_xfern</code> to the local master to signify Data 3 are available on <code>l_data_out[31:0]</code>. With <code>lm_data_xfern</code> asserted, the local master can safely read Data 3.</p>
12	Idle	The Core relinquishes control of <code>irdyn</code> and de-asserts <code>lm_data_xfern</code> , and the local master de-asserts <code>lm_rdyn</code> since all of the burst data have been read.

Figure 2-16 and Table 2-20 show an example of a 32-bit burst data transfer during a write transaction with the assumption that the device select timing is set to slow and wait states are not inserted. The figure illustrates how the PCI interface correlates to the Local Master Interface. The table gives a clock-by-clock description of each event that occurs in the figure.

Figure 2-16. 32-bit Master Burst Write Transaction with a 32-bit Local Interface

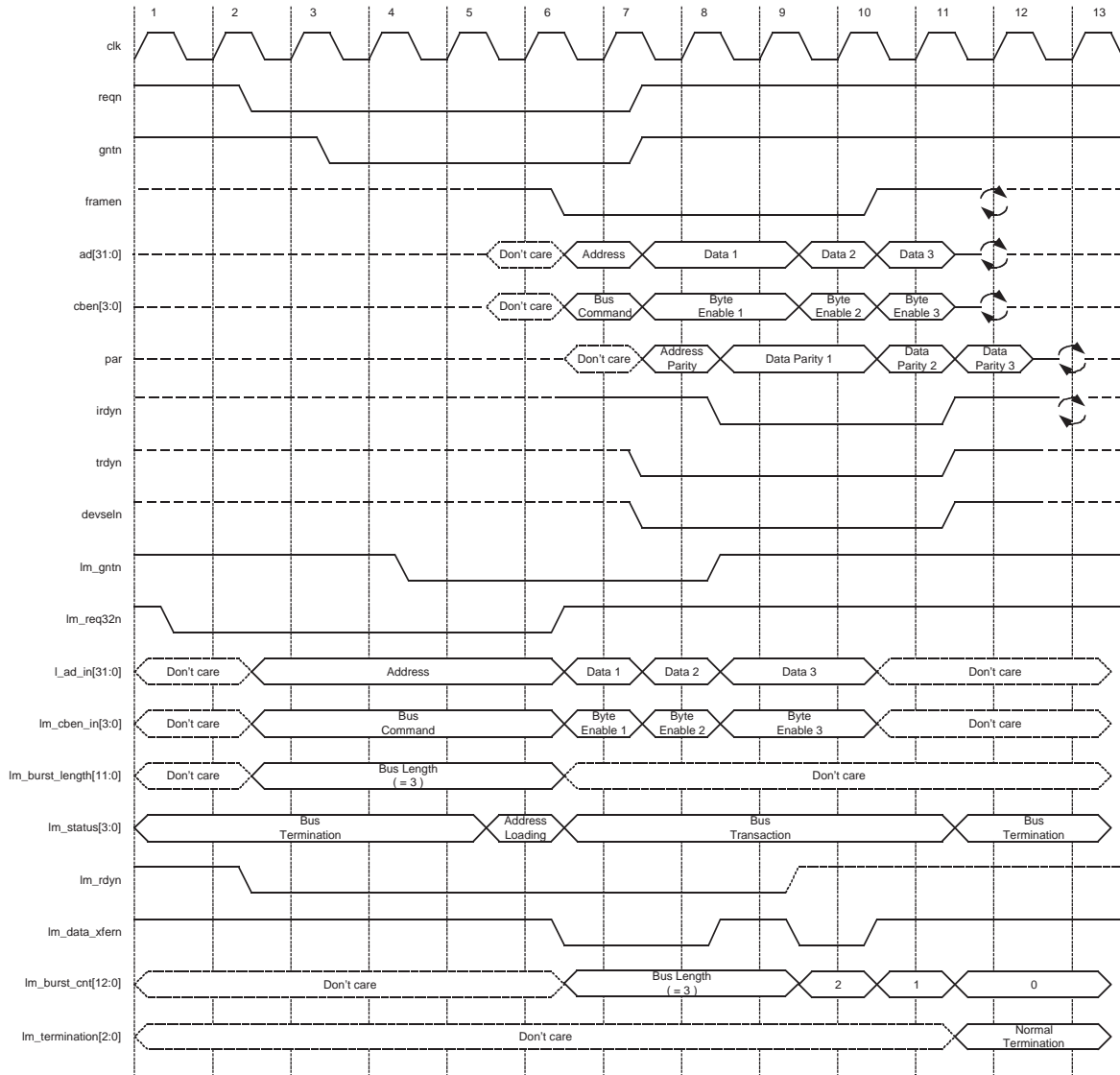

Table 2-20. 32-bit Master Burst Write Transaction with a 32-Bit Local Interface

CLK	Phase	Description
1	Idle	The <code>lm_req32n</code> signal is asserted by the local master to request a 32-bit data transaction. The local master issues the PCI starting address, the bus command, and the burst length during the same clock cycle on <code>l_ad_in</code> , <code>lm_cben_in</code> and <code>lm_burst_length</code> , respectively.
2	Idle	The Core's Local Master Interface detects the asserted <code>lm_req32n</code> and asserts <code>reqn</code> to request the use of PCI bus.
3	Idle	<code>gntn</code> is asserted to grant the Core access to the PCI bus. Core is now the PCI master.
4	Idle	Since <code>gntn</code> is asserted and the current bus is idle, the Core is going to start the bus transactions. The Core asserts <code>lm_gntn</code> to inform the local master that the bus request is granted.
5	Idle	If both <code>lm_req32n</code> and <code>gntn</code> were asserted on the previous cycle, <code>lm_status[3:0]</code> is changed to 'Address Loading' to indicate the starting address, the bus command and the burst length are being latched.

Table 2-20. 32-bit Master Burst Write Transaction with a 32-Bit Local Interface (Continued)

CLK	Phase	Description
6	Address	<p>The local master de-asserts <code>lm_req32n</code> when the previous <code>lm_status[3:0]</code> was 'Address Loading' and if it doesn't want to request another PCI bus transaction.</p> <p>The Core asserts <code>framen</code> to initiate the 32-bit write transaction when <code>gntn</code> was asserted and <code>lm_status[3:0]</code> was 'Address Loading' on the previous cycle. It also drives the PCI starting address on <code>ad[31:0]</code> and the PCI command on <code>cben[3:0]</code>. On the same cycle, it outputs <code>lm_status[3:0]</code> as 'Bus Transaction' to indicate the beginning of the address/data phases.</p> <p><code>lm_burst_cnt</code> gets the value of the burst length.</p> <p>Because <code>lm_rdyn</code> was asserted on the previous cycle and the next cycle is the first data phase, the local master should provide Data 1 on <code>l_ad_in[31:0]</code> and the byte enables on <code>lm_cben_in[3:0]</code>. And the Core asserts <code>lm_data_xfern</code> to the local master to signify these data and byte enables are being read and will be transferred to the PCI bus.</p> <p>Asserting <code>lm_rdyn</code> means the local master is ready to write data. If it is not, it should keep <code>lm_rdyn</code> de-asserted until it is ready.</p>
7	Wait	<p>The Core de-asserts <code>reqn</code> after the assertion of <code>framen</code>.</p> <p><code>lm_data_xfern</code> is asserted to signify Data 2 on <code>l_ad_in[31:0]</code> and the byte enables on <code>lm_cben_in[3:0]</code> are being read and will be transferred to the PCI bus.</p> <p>If the local master is ready to provide the next DWORD, it keeps <code>lm_rdyn</code> asserted.</p>
8	Data 1	<p>The Core keeps <code>framen</code> asserted and asserts <code>irdyn</code>. It also de-asserts <code>lm_data_xfern</code> to the local master to signify Data 3 on <code>l_ad_in[31:0]</code> is not read.</p> <p>If the local master is ready to provide the next DWORD, it keeps <code>lm_rdyn</code> asserted.</p> <p>Because the Core performs the burst transactions, it keeps <code>framen</code> asserted.</p> <p>Since both <code>irdyn</code> and <code>trdyn</code> are asserted, the first data phase is completed on this cycle.</p>
9	Data 2	<p>Since the previous data phase was completed, the Core decreases <code>lm_burst_cnt</code>.</p> <p>Since Data 1 on PCI bus were read by the target, the Core transfers Data 2 and their byte enables to <code>ad[31:0]</code> and <code>cben[3:0]</code>.</p> <p>With <code>lm_rdyn</code> asserted previous cycle, the Core keeps <code>irdyn</code> asserted.</p> <p>Because both <code>lm_rdyn</code> and <code>trdyn</code> were asserted on the previous cycle, the Core asserts <code>lm_data_xfern</code> to the local master to signify Data 3 on <code>l_ad_in[31:0]</code> and the byte enables on <code>lm_cben_in[3:0]</code> are being read and will be transferred to the PCI bus.</p> <p>Because Data 3 are the last data, the local master de-asserts <code>lm_rdyn</code>.</p> <p>Since both <code>irdyn</code> and <code>trdyn</code> are asserted, the second data phase is completed on this cycle.</p>
10	Data 3	<p>Since the previous data phase was completed, the Core decreases <code>lm_burst_cnt</code>.</p> <p>Since Data 2 on the PCI bus were read, the Core transfers Data 3 and their byte enables to <code>ad[31:0]</code> and <code>cben[3:0]</code>.</p> <p>Because the current transaction is the last, the Core de-asserts <code>framen</code> to signal the end of the burst, also it de-asserts <code>lm_data_xfern</code>.</p> <p>Since both <code>irdyn</code> and <code>trdyn</code> are asserted, the third data phase is completed on this cycle.</p>
11	Turn around	<p>The Core relinquishes control of <code>framen</code>, <code>ad</code> and <code>cben</code>. It de-asserts <code>irdyn</code>, decreases <code>lm_burst_cnt</code> to zero and changes <code>lm_status[3:0]</code> into 'Bus Termination' with <code>lm_termination</code> as 'Normal Termination' because both <code>trdyn</code> and <code>irdyn</code> were asserted last cycle. The target de-asserts <code>devseln</code> and <code>trdyn</code>.</p>
12	Idle	<p>The Core relinquishes control of <code>irdyn</code> and <code>par</code>.</p>

64-bit PCI Master with a 64-bit Local Bus

The following discusses read and write burst transactions for the PCI IP core configured with a 64-bit PCI bus and a 64-bit Local bus. [Figure 2-17](#) and [Table 2-21](#) illustrate a 64-bit burst write transaction. The figure shows how the PCI Interface correlates to the Local Master Interface. The table gives a clock-by-clock description of each event that occurs in the figure.

The 32-bit burst transaction is similar to a 32-bit burst transaction for the 64-bit PCI IP core configuration. When the 64-bit target core responds to a 32-bit burst transaction, the upper 32 bits of the data bus are ignored.

Figure 2-17. 64-bit Master Burst Read Transaction with a 64-bit Local Interface



Table 2-21. 64-bit Master Burst Read Transaction with a 64-bit Local Interface

CLK	Phase	Description
1	Idle	The local master asserts <code>lm_req64n</code> to request 64-bit wide data transaction. It also issues the PCI starting address, the bus command and the burst length will be available on <code>l_ad_in</code> , <code>lm_cben_in</code> and <code>lm_burst_length</code> respectively on the same clock cycle.
2	Idle	The Core's Local Master Interface detects the asserted <code>lm_req64n</code> and asserts <code>reqn</code> to request the use of PCI bus.
3	Idle	<code>gntn</code> is asserted to grant the Core access to the PCI bus. Core is now the PCI master.
4	Idle	Since <code>gntn</code> is asserted and the current bus is idle, the Core is going to start the bus transactions. The Core asserts <code>lm_gntn</code> to inform the local master that the bus request is granted.
5	Idle	If both <code>lm_req64n</code> and <code>lm_gntn</code> were asserted on the previous cycle, <code>lm_status[3:0]</code> is changed to 'Address Loading' to indicate the starting address, the bus command and the burst length are being latched.
6	Address	<p>The local master de-asserts <code>lm_req64n</code> when the previous <code>lm_status[3:0]</code> was 'Address Loading' and if it doesn't want to request another PCI bus transaction.</p> <p>The Core asserts <code>framen</code> and <code>req64n</code> to initiate the 64-bit read transaction when <code>gntn</code> was still asserted and <code>lm_status[3:0]</code> was 'Address Loading' on the previous cycle. It also drives the PCI starting address on <code>ad[31:0]</code> and the PCI command on <code>cben[3:0]</code>. On the same cycle, it outputs <code>lm_status[3:0]</code> as 'Bus Transaction' to indicate the beginning of the address/data phases.</p> <p><code>lm_burst_cnt</code> gets the value of the burst length.</p> <p>Because <code>lm_rdyn</code> was asserted on the previous cycle and the next cycle is the first data phase, the local master provides the byte enables on <code>lm_cben_in[7:0]</code>. Asserting <code>lm_rdyn</code> also means the local master is ready to read data. If it is not ready to read data, it keeps <code>lm_rdyn</code> de-asserted until it is ready.</p>
7	Turn around	<p>The Core de-asserts <code>reqn</code> when <code>framen</code> was asserted but <code>lm_req64n</code> was de-asserted on the previous cycle.</p> <p>The target asserts <code>devseln</code> and <code>ack64n</code> to indicate it acknowledges the 64-bit transaction. The Core tri-states the <code>ad[63:0]</code> lines and drives the byte enables (Byte Enable 1 and 2). Since <code>lm_rdyn</code> was asserted on the previous cycle, it asserts <code>irdyn</code> to indicate it is ready to read data. Because the Core performs burst data transfer, it keeps <code>framen</code> asserted.</p>
8	Data 1 and 2	<p>The Core asserts <code>lm_64bit_transn</code> to indicate the current data transaction is 64 bits wide. It de-asserts <code>lm_gntn</code> to follow <code>gntn</code>.</p> <p>The target asserts <code>trdyn</code> and puts Data 1 and 2 on <code>ad[63:0]</code>.</p> <p>With <code>lm_rdyn</code> asserted on the previous cycle, the Core keeps <code>irdyn</code> asserted.</p> <p>The Core keeps <code>framen</code> asserted to the target to signify the burst continues. It de-asserts <code>lm_gntn</code> to follow <code>gntn</code>.</p> <p>If the local master is ready to read the first QWORD, it keeps <code>lm_rdyn</code> asserted.</p> <p>Since both <code>irdyn</code> and <code>trdyn</code> are asserted, the first data phase is completed on this cycle.</p>
9	Data 3 and 4	<p>Since the previous data phase was completed, the Core transfers Data 1 and 2 on <code>l_data_out[63:0]</code> and decreases the <code>lm_burst_cnt</code>.</p> <p>If both <code>trdyn</code> and <code>lm_rdyn</code> were asserted on the previous cycle, the Core asserts <code>lm_ldata_xfern</code> and <code>lm_hdata_xfern</code> to the local master to signify Data 1 and 2 are available on <code>l_data_out[63:0]</code>. With <code>lm_ldata_xfern</code> and <code>lm_hdata_xfern</code> asserted, the local master can safely read Data 1 and 2 and increment the address counter.</p> <p>If the local master keeps <code>lm_rdyn</code> asserted on the previous cycle, the Core keeps <code>irdyn</code> asserted.</p> <p>The Core keeps <code>framen</code> asserted to the target to signify the burst continues.</p> <p>If the target is still ready to provide data, it keeps <code>trdyn</code> asserted and drives the next QWORD (Data 3 and 4) on <code>ad[63:0]</code>.</p> <p>If the local master is ready to read the next QWORD, it keeps <code>lm_rdyn</code> asserted.</p> <p>Since both <code>irdyn</code> and <code>trdyn</code> are asserted, the second data phase is completed on this cycle.</p>

Table 2-21. 64-bit Master Burst Read Transaction with a 64-bit Local Interface (Continued)

CLK	Phase	Description
10	Data 5 and 6	<p>Since the previous data phase was completed, the Core transfers Data 3 and 4 on <code>l_data_out[63:0]</code> and decreases the <code>lm_burst_cnt</code>.</p> <p>If both <code>trdyn</code> and <code>lm_rdyn</code> were asserted on the previous cycle, the Core asserts <code>lm_ldata_xfern</code> and <code>lm_hdata_xfern</code> to the local master to signify Data 3 and 4 are available on <code>l_data_out[63:0]</code>. With <code>lm_ldata_xfern</code> and <code>lm_hdata_xfern</code> asserted, the local master can safely read Data 3 and 4 and increment the address counter.</p> <p>With <code>lm_rdyn</code> asserted on the previous cycle, the Core keeps <code>irdyn</code> asserted.</p> <p>Because the current transaction is the last, the Core de-asserts <code>framen</code> and <code>req64n</code> to signal the end of the burst.</p> <p>If the target is still ready to provide data, it keeps <code>trdyn</code> asserted and drives the next QWORD (Data 5 and 6) on <code>ad[63:0]</code>.</p> <p>If the local master is ready to read the next QWORD, it keeps <code>lm_rdyn</code> asserted.</p> <p>Since both <code>irdyn</code> and <code>trdyn</code> are asserted, the third data phase is completed on this cycle.</p>
11	Turn around	<p>Since the previous data phase was completed, the Core transfers Data 5 and 6 on <code>l_data_out[63:0]</code> and decreases the <code>lm_burst_cnt</code> to zero.</p> <p>The Core relinquishes control of <code>framen</code>, <code>req64n</code> and <code>cben</code>. It de-asserts <code>irdyn</code> and changes <code>lm_status[3:0]</code> into 'Bus Termination' with <code>lm_termination</code> as 'Normal Termination' because both <code>trdyn</code> and <code>irdyn</code> were asserted last cycle.</p> <p>The target relinquishes control of <code>ad[63:0]</code>. It de-asserts <code>devseln</code>, <code>ack64n</code> and <code>trdyn</code>.</p> <p>If both <code>trdyn</code> and <code>lm_rdyn</code> were asserted on the previous cycle, the Core asserts <code>lm_ldata_xfern</code> and <code>lm_hdata_xfern</code> to the local master to signify Data 5 and 6 are available on <code>l_data_out[63:0]</code>. With <code>lm_ldata_xfern</code> and <code>lm_hdata_xfern</code> asserted, the local master can safely read Data 5 and 6.</p>
12	Idle	<p>The Core relinquishes control of <code>irdyn</code> and de-asserts <code>lm_ldata_xfern</code> and <code>lm_hdata_xfern</code>, and the local master de-asserts <code>lm_rdyn</code> since all of the burst data have been read.</p>

Figure 2-18 and Table 2-22 illustrate a 64-bit burst write transaction. The figure shows how the PCI interface correlates to the Local Master Interface. The table gives a clock-by-clock description of each event that occurs in the figure.

Figure 2-18. 64-bit Master Burst Write Transaction with a 64-bit Local Interface



Table 2-22. 64-bit Master Burst Write Transaction with a 64-bit Local Interface

CLK	Phase	Description
1	Idle	The local master asserts <code>lm_req64n</code> to request for 64-bit wide data transaction. It also issues the PCI starting address, the bus command and the burst length on <code>l_ad_in</code> , <code>lm_cben_in</code> and <code>lm_burst_length</code> respectively on the same clock cycle.
2	Idle	The Core's Local Master Interface detects the asserted <code>lm_req64n</code> and asserts <code>reqn</code> to request the use of PCI bus.
3	Idle	<code>gntn</code> is asserted to grant the Core access to the PCI bus. Core is now the PCI master.
4	Idle	Since <code>gntn</code> is asserted and the current bus is idle, the Core is going to start the bus transactions. The Core asserts <code>lm_gntn</code> to inform the local master that the bus request is granted.
5	Idle	If both <code>lm_req64n</code> and <code>lm_gntn</code> were asserted on the previous cycle, <code>lm_status[3:0]</code> is changed to 'Address Loading' to indicate the starting address, the bus command and the burst length are being latched.
6	Address	<p>The local master de-asserts <code>lm_req64n</code> when the previous <code>lm_status[3:0]</code> was 'Address Loading' and if it doesn't want to request another PCI bus transaction.</p> <p>The Core asserts <code>framen</code> and <code>req64n</code> to initiate the 64-bit write transaction when <code>gntn</code> was asserted and <code>lm_status[3:0]</code> was 'Address Loading' on the previous cycle. It also drives the PCI starting address on <code>ad[31:0]</code> and the PCI command on <code>cben[3:0]</code>. On the same cycle, it outputs <code>lm_status[3:0]</code> as 'Bus Transaction' to indicate the beginning of the address/data phases.</p> <p><code>lm_burst_cnt</code> gets the value of the burst length.</p> <p>Because <code>lm_rdyn</code> was asserted on the previous cycle and the next cycle is the first data phase, the local master provides Data 1 and Data 2 on <code>l_ad_in[63:0]</code> and the byte enables on <code>lm_cben_in[7:0]</code>. And the Core asserts <code>lm_ldata_xfern</code> and <code>lm_hdata_xfern</code> to the local master to signify these data and byte enables are being read and will be transferred to the PCI bus.</p> <p>Asserting <code>lm_rdyn</code> means the local master is ready to write data. If it is not, it keeps <code>lm_rdyn</code> de-asserted until it is ready.</p>
7	Wait	<p>The Core de-asserts <code>reqn</code> when <code>framen</code> was asserted but <code>lm_req64n</code> was de-asserted on the previous cycle.</p> <p>If the target completes the fast decode and is ready to receive 64-bit data, it asserts <code>devseln</code>, <code>ack64n</code> and <code>trdyn</code>.</p> <p>With <code>lm_ldata_xfern</code> and <code>lm_hdata_xfern</code> asserted on the previous cycle that was the address phase, the local master should increment the address counter while the Core transfers Data 1 and Data 2 and their byte enables to <code>ad[63:0]</code> and <code>cben[7:0]</code>.</p> <p>With <code>lm_rdyn</code> asserted on the previous cycle, the local master provides Data 3 and Data 4 on <code>l_ad_in[63:0]</code> and the byte enables on <code>lm_cben_in[7:0]</code>. Because this is the first write data phase and <code>devseln</code> is just asserted, the Core keeps <code>framen</code> asserted and <code>irdyn</code> de-asserted to judge 64-bit or 32-bit transactions. It also de-asserts <code>lm_ldata_xfern</code> and <code>lm_hdata_xfern</code> to the local master to signify that Data 3 and Data 4 on <code>l_ad_in[63:0]</code> are not read.</p> <p>If the local master is ready to provide the next QWORD, it keeps <code>lm_rdyn</code> asserted.</p> <p>Since <code>irdyn</code> is not asserted, the first data phase is not completed.</p>
8	Wait	<p>Since <code>lm_ldata_xfern</code> and <code>lm_hdata_xfern</code> were not asserted on the previous cycle, the local master keeps Data 3 and Data 4 on <code>l_ad_in[63:0]</code> and the byte enables on <code>lm_cben_in[7:0]</code>.</p> <p>Because the Core needs one more cycle to decide 64-bit or 32-bit transaction, it keeps <code>framen</code> asserted and <code>irdyn</code> de-asserted. It also keeps <code>lm_ldata_xfern</code> and <code>lm_hdata_xfern</code> de-asserted to the local master to signify Data 3 and Data 4 on <code>l_ad_in[63:0]</code> are not read.</p> <p>The Core asserts <code>lm_64bit_transn</code> to indicate the current data transaction is 64 bits wide. It de-asserts <code>lm_gntn</code> to follow <code>gntn</code>.</p> <p>If the local master is ready to provide the next QWORD, it keeps <code>lm_rdyn</code> asserted.</p> <p>Since <code>irdyn</code> is not asserted, the first data phase is not completed.</p>

Table 2-22. 64-bit Master Burst Write Transaction with a 64-bit Local Interface (Continued)

CLK	Phase	Description
9	Data 1 and 2	<p>Since <code>lm_ldata_xfern</code> and <code>lm_hdata_xfern</code> were not asserted on the previous cycle, the local master keeps Data 3 and Data 4 on <code>l_ad_in[63:0]</code> and the byte enables on <code>lm_cben_in[7:0]</code>.</p> <p>With both <code>devseln</code> and <code>lm_rdyn</code> asserted in the previous cycle, the Core asserts <code>irdyn</code>, and it prepares for the 64-bit write burst. So it asserts <code>lm_ldata_xfern</code> and <code>lm_hdata_xfern</code> to the local master to signify Data 3 and Data 4 on <code>l_ad_in[63:0]</code> and the byte enables on <code>lm_cben_in[7:0]</code> are being read and will be transferred to the PCI bus.</p> <p>The Core keeps <code>framen</code> asserted and asserts <code>irdyn</code>. It also keeps <code>lm_ldata_xfern</code> and <code>lm_hdata_xfern</code> de-asserted to the local master to signify Data 3 and Data 4 on <code>l_ad_in[63:0]</code> are not read.</p> <p>If the local master is ready to provide the next QWORD, it keeps <code>lm_rdyn</code> asserted.</p> <p>Because the Core performs the burst transactions, it keeps <code>framen</code> asserted.</p> <p>Since both <code>irdyn</code> and <code>trdyn</code> are asserted, the first data phase is completed on this cycle.</p>
10	Data 3 and 4	<p>Since the previous data phase was completed, the Core decreases '<code>lm_burst_cnt</code>'.</p> <p>With <code>lm_ldata_xfern</code> and <code>lm_hdata_xfern</code> asserted on the previous cycle, the local master should increment the address counter.</p> <p>Since Data 1 and Data 2 on the PCI bus were read by the target, the Core transfers Data 3 and Data 4 and their byte enables to <code>ad[63:0]</code> and <code>cben[7:0]</code>.</p> <p>With <code>lm_rdyn</code> asserted previous cycle, the Core keeps <code>irdyn</code> asserted.</p> <p>With <code>lm_ldata_xfern</code> and <code>lm_hdata_xfern</code> asserted on the previous cycle, the local master provides Data 5 and Data 6 on <code>l_ad_in[63:0]</code> and the byte enables on <code>lm_cben_in[7:0]</code>.</p> <p>Because both <code>lm_rdyn</code> and <code>trdyn</code> were asserted on the previous cycle, the Core asserts <code>lm_ldata_xfern</code> and <code>lm_hdata_xfern</code> to the local master to signify Data 5 and Data 6 on <code>l_ad_in[63:0]</code> and the byte enables on <code>lm_cben_in[7:0]</code> are being read and will be transferred to the PCI bus. Because Data 5 and Data 6 are the last data, the local master de-asserts <code>lm_rdyn</code>. The Core keeps <code>framen</code> asserted to signify the burst continues. Since both <code>irdyn</code> and <code>trdyn</code> are asserted, the second data phase is completed on this cycle.</p>
11	Data 5 and 6	<p>Since the previous data phase was completed, the Core decreases '<code>lm_burst_cnt</code>'.</p> <p>Since Data 3 and Data 4 on PCI bus were read, the Core transfers Data 5 and Data 6 and their byte enables to <code>ad[63:0]</code> and <code>cben[7:0]</code>.</p> <p>With <code>lm_rdyn</code> asserted previous cycle, the Core keeps <code>irdyn</code> asserted.</p> <p>Because the current transaction is the last, the Core de-asserts <code>framen</code> and <code>req64n</code> to signal the end of the burst, also it de-asserts <code>lm_ldata_xfern</code> and <code>lm_hdata_xfern</code>.</p> <p>Since both <code>irdyn</code> and <code>trdyn</code> are asserted, the third data phase is completed on this cycle.</p>
12	Turn around	<p>The Core relinquishes control of <code>framen</code>, <code>req64n</code>, <code>ad</code> and <code>cben</code>. It de-asserts <code>irdyn</code>, decreases '<code>lm_burst_cnt</code>' to zero and changes <code>lm_status[3:0]</code> into 'Bus Termination' with <code>lm_termination</code> as 'Normal Termination' because both <code>trdyn</code> and <code>irdyn</code> were asserted last cycle. The target de-asserts <code>devseln</code>, <code>ack64n</code> and <code>trdyn</code>.</p>
13	Idle	<p>The Core relinquishes control of <code>irdyn</code>, <code>par</code> and <code>par64</code>.</p>

32-bit PCI Master with a 64-Bit Local Bus

The following discusses read and write transactions for a PCI IP core configured with a 32-bit PCI bus and a 64-bit local bus. Two PCI data phases are required when writing or reading 64-bit data via the Local Master Interface.

The 32-bit PCI transaction, as described in the 32-Bit PCI Master and 32-Bit Local Bus section, is similar to these transactions; however, 32-bit data on a 64-bit data path is handled differently at the Local Master Interface. When the 64-bit target core responds to a 32-bit transaction, the upper 32 bits of the Local data bus should be ignored or return 0's.

With a 64-bit back-end, the address counter needs to increment only by a QWORD (eight bytes). As a result, the local back-end control latches the complete QWORD and routes the proper DWORD to the PCI data bus. The `lm_ldata_xfern` and `lm_hdata_xfern` signals specify which DWORD is transferred.

If the starting address is QWORD aligned, the first DWORD is assumed to be the lower DWORD of a QWORD. Otherwise, it is the upper DWORD. If the starting address is not QWORD aligned, it must be DWORD aligned.

[Figure 2-19](#) and [Table 2-23](#) illustrate a burst transaction to a 32-bit PCI IP core with a 64-bit Local Master Interface. The figure illustrates how the PCI interface correlates to the Local Master Interface. The table gives a clock-by-clock description of each event in the figure.

Figure 2-19. 32-bit Master Burst Read Transaction with a 64 bit Local Interface



Table 2-23. 32-bit Master Burst Read Transaction with a 64-Bit Local Interface

CLK	Phase	Description
1	Idle	The <code>lm_req32n</code> signal is asserted by the local master to request 32-bit data transaction. The local master issues the PCI starting address, the bus command, and the burst length during the same clock cycle to <code>l_ad_in</code> , <code>lm_cben_in</code> , and <code>lm_burst_length</code> , respectively.
2	Idle	The Core's Local Master Interface detects the asserted <code>lm_req32n</code> and asserts <code>reqn</code> to request the use of PCI bus.
3	Idle	<code>gntn</code> is asserted to grant the Core access to the PCI bus. Core is now the PCI master.
4	Idle	Since <code>gntn</code> is asserted and the current bus is idle, the Core starts the bus transactions. The Core asserts <code>lm_gntn</code> to inform the local master that the bus request is granted.
5	Idle	If both <code>lm_req32n</code> and <code>gntn</code> were asserted on the previous cycle, <code>lm_status[3:0]</code> is changed to 'Address Loading' to indicate the starting address, the bus command, and the burst length are being latched.
6	Address	<p>The Core asserts <code>framen</code> to start transaction and the local master de-asserts <code>lm_req32n</code> when the previous <code>lm_status[3:0]</code> was 'Address Loading' and if it doesn't want to request another PCI bus transaction.</p> <p><code>lm_status[3:0]</code> was 'Address Loading' on the previous cycle. It also drives the PCI starting address on <code>ad[31:0]</code> and the PCI command on <code>cben[3:0]</code>. On the same cycle, it outputs <code>lm_status[3:0]</code> as 'Bus Transaction' to indicate the beginning of the address/data phases. <code>lm_burst_cnt</code> gets the value of the burst length.</p> <p>Because <code>lm_rdyn</code> was asserted on the previous cycle and the next cycle is the first data phase, the local master provides the byte enables on <code>lm_cben_in[3:0]</code>. Asserting <code>lm_rdyn</code> also means the local master is ready to read data. If it is not ready to read data, it keep <code>lm_rdyn</code> de-asserted until it is ready.</p>
7	Turn around	<p>The Core de-asserts <code>reqn</code> when <code>framen</code> was asserted but <code>lm_req64n</code> was de-asserted on the previous cycle.</p> <p>The target only asserts <code>devseln</code> to indicate it doesn't acknowledge the 64-bit transaction.</p> <p>The Core tri-states the <code>ad[31:0]</code> lines and drives the byte enables (Byte Enable 1). Since <code>lm_rdyn</code> was asserted on the previous cycle, it asserts <code>irdyn</code> to indicate it is ready to read data. Because the master performs the burst transactions, it keeps <code>framen</code> asserted.</p>
8	Data 1	<p>The Core de-asserts <code>lm_64bit_transn</code> to indicate the current data transaction is 32-bit wide. It de-asserts <code>lm_gntn</code> to follow <code>gntn</code>.</p> <p>The target asserts <code>trdyn</code> and puts Data 1 on <code>ad[31:0]</code>.</p> <p>With <code>lm_rdyn</code> asserted on the previous cycle, the Core keeps <code>irdyn</code> asserted.</p> <p>The Core keeps <code>framen</code> asserted to the target to signify the burst continues.</p> <p>If the local master is ready to read the first DWORD, it keeps <code>lm_rdyn</code> asserted.</p> <p>Since both <code>irdyn</code> and <code>trdyn</code> are asserted, the first data phase is completed on this cycle.</p>
9	Data 2	<p>Since the previous data phase was completed, the Core transfers Data 1 on <code>l_data_out[31:0]</code> and decreases the <code>lm_burst_cnt</code>.</p> <p>If both <code>trdyn</code> and <code>lm_rdyn</code> were asserted on the previous cycle, the Core asserts <code>lm_ldata_xfern</code> and de-asserts <code>lm_hdata_xfern</code> to the local master to signify Data 1 are available on <code>l_data_out[31:0]</code>. With <code>lm_ldata_xfern</code> asserted, the local master can safely read Data 1 and increment the address counter.</p> <p>If the local master keeps <code>lm_rdyn</code> asserted on the previous cycle, the Core keeps <code>irdyn</code> asserted.</p> <p>The Core keeps <code>framen</code> asserted to the target to signify the burst continues.</p> <p>If the target is still ready to provide data, it keeps <code>trdyn</code> asserted and drives the next DWORD (Data 2) on <code>ad[31:0]</code>.</p> <p>If the local master is ready to read the next DWORD, it keeps <code>lm_rdyn</code> asserted. Since both <code>irdyn</code> and <code>trdyn</code> are asserted, the second data phase is completed on this cycle.</p>

Table 2-23. 32-bit Master Burst Read Transaction with a 64-Bit Local Interface (Continued)

CLK	Phase	Description
10	Data 3	<p>Since the previous data phase was completed, the Core transfers Data 2 on <code>l_data_out[63:32]</code> and decreases the <code>lm_burst_cnt</code>.</p> <p>If both <code>trdyn</code> and <code>lm_rdyn</code> were asserted on the previous cycle, the Core de-asserts <code>lm_ldata_xfern</code> and asserts <code>lm_hdata_xfern</code> to the local master to signify Data 2 are available on <code>l_data_out[63:32]</code>. With <code>lm_hdata_xfern</code> asserted, the local master can safely read Data 2 and increment the address counter.</p> <p>With <code>lm_rdyn</code> asserted on the previous cycle, the Core keeps <code>irdyn</code> asserted. If the target is still ready to provide data, it keeps <code>trdyn</code> asserted and drives the next DWORD (Data 3) on <code>ad[31:0]</code>.</p> <p>If the local master is ready to read the next DWORD, it keeps <code>lm_rdyn</code> asserted.</p> <p>Since both <code>irdyn</code> and <code>trdyn</code> are asserted, the third data phase is completed on this cycle.</p>
11	Data 4	<p>Since the previous data phase was completed, the Core transfers Data 3 on <code>l_data_out[31:0]</code> and decreases the <code>lm_burst_cnt</code>.</p> <p>If both <code>trdyn</code> and <code>lm_rdyn</code> were asserted on the previous cycle, the Core asserts <code>lm_ldata_xfern</code> and de-asserts <code>lm_hdata_xfern</code> to the local master to signify Data 3 are available on <code>l_data_out[31:0]</code>. With <code>lm_ldata_xfern</code> asserted, the local master can safely read Data 3 and increment the address counter.</p> <p>With <code>lm_rdyn</code> asserted on the previous cycle, the Core keeps <code>irdyn</code> asserted.</p> <p>Because the current transaction is the last, the Core de-asserts <code>framen</code> and <code>req64n</code> to signal the end of the burst. If the target is still ready to provide data, it keeps <code>trdyn</code> asserted and drives the next DWORD (Data 4) on <code>ad[31:0]</code>.</p> <p>If the local master is ready to read the next DWORD, it keeps <code>lm_rdyn</code> asserted.</p> <p>Since both <code>irdyn</code> and <code>trdyn</code> are asserted, the fourth data phase is completed on this cycle.</p>
12	Turn around	<p>Since the previous data phase was completed, the Core transfers Data 4 on <code>l_data_out[63:32]</code> and decreases the <code>lm_burst_cnt</code> to zero.</p> <p>The Core relinquishes control of <code>framen</code>, <code>req64n</code> and <code>cben</code>. It de-asserts <code>irdyn</code> and changes <code>lm_status[3:0]</code> into 'Bus Termination' with <code>lm_termination</code> as 'Normal Termination' because both <code>trdyn</code> and <code>irdyn</code> were asserted last cycle.</p> <p>The target relinquishes control of <code>ad[31:0]</code>. It de-asserts <code>devseln</code> and <code>trdyn</code>.</p> <p>If both <code>trdyn</code> and <code>lm_rdyn</code> were asserted on the previous cycle, the Core de-asserts <code>lm_ldata_xfern</code> and asserts <code>lm_hdata_xfern</code> to the local master to signify Data 4 are available on <code>l_data_out[63:32]</code>. With <code>lm_hdata_xfern</code> asserted, the local master can safely read Data 4.</p>
12	Idle	<p>The Core relinquishes control of <code>irdyn</code> and de-asserts <code>lm_ldata_xfern</code> and <code>lm_hdata_xfern</code>, and the local master de-asserts <code>lm_rdyn</code> since all of the burst data have been read.</p>

Figure 2-20 and Table 2-24 illustrate a burst transaction for a 32-bit PCI IP core with a 64-bit Local Interface. The figure shows how the PCI interface correlates to the Local Interface. The table gives a clock-by-clock description of each event illustrated in the figure.

Figure 2-20. 32-bit Master Burst Write Transaction With a 64-bit Local Interface



Table 2-24. 32-bit Master Burst Write Transaction With a 64-bit Local Interface

CLK	Phase	Description
1	Idle	The local master asserts <code>lm_req32n</code> for the master 32-bit data transaction request. It also issues the PCI starting address, the bus command and the burst length on <code>l_ad_in</code> , <code>lm_cben_in</code> and <code>lm_burst_length</code> respectively during the same clock cycle.
2	Idle	The Core's Local Master Interface detects the asserted <code>lm_req64n</code> and asserts <code>reqn</code> to request the use of PCI bus.
3	Idle	<code>gntn</code> is asserted to grant the Core access to the PCI bus. Core is now the PCI master.
4	Idle	Since <code>gntn</code> is asserted and the current bus is idle, the Core starts the bus transactions. The Core asserts <code>lm_gntn</code> to inform the local master that the bus request is granted.
5	Idle	If both <code>lm_req64n</code> and <code>gntn</code> were asserted on the previous cycle, <code>lm_status[3:0]</code> is changed to 'Address Loading' to indicate the starting address, the bus command and the burst length are being latched.
6	Address	<p>The local master de-asserts <code>lm_req64n</code> when the previous <code>lm_status[3:0]</code> was 'Address Loading' and if it doesn't want to request another PCI bus transaction.</p> <p>The Core asserts <code>framen</code> and <code>req64n</code> to initiate the 64-bit write transaction when <code>gntn</code> was asserted and <code>lm_status[3:0]</code> was 'Address Loading' on the previous cycle. It also drives the PCI starting address on <code>ad[31:0]</code> and the PCI command on <code>cben[3:0]</code>. On the same cycle, it outputs <code>lm_status[3:0]</code> as 'Bus Transaction' to indicate the beginning of the address/data phases.</p> <p><code>lm_burst_cnt</code> gets the value of the burst length.</p> <p>Because <code>lm_rdyn</code> was asserted on the previous cycle and the next cycle is the first data phase, the local master should provide Data 1 and Data 2 on <code>l_ad_in[63:0]</code> and the byte enables on <code>lm_cben_in[7:0]</code>. And the Core asserts <code>lm_ldata_xfern</code> and <code>lm_hdata_xfern</code> to the local master to signify these data and byte enables are being read and will be transferred to the PCI bus.</p> <p>Asserting <code>lm_rdyn</code> means the local master is ready to write data. If it is not, it should keep <code>lm_rdyn</code> de-asserted until it is ready.</p>
7	Wait	<p>The Core de-asserts <code>reqn</code> when <code>framen</code> was asserted but <code>lm_req64n</code> was de-asserted on the previous cycle.</p> <p>If the target completes the fast decode and is ready to receive 32-bit data, it asserts <code>devseln</code> and <code>trdyn</code> and doesn't asserts <code>ack64n</code>.</p> <p>With <code>lm_ldata_xfern</code> and <code>lm_hdata_xfern</code> asserted on the previous cycle that was the address phase, the local master should increment the address counter while the Core transfers Data 1 and Data 2 and their byte enables to <code>ad[63:0]</code> and <code>cben[7:0]</code>.</p> <p>With <code>lm_rdyn</code> asserted on the previous cycle, the local master provides Data 3 and Data 4 on <code>l_ad_in[63:0]</code> and the byte enables on <code>lm_cben_in[7:0]</code>.</p> <p>Because this is the first write data phase and <code>devseln</code> is just asserted, the Core keeps <code>framen</code> asserted and <code>irdyn</code> de-asserted to judge 64-bit or 32-bit transaction. It also de-asserts <code>lm_ldata_xfern</code> and <code>lm_hdata_xfern</code> to the local master to signify Data 3 and Data 4 on <code>l_ad_in[63:0]</code> are not read.</p> <p>Since <code>irdyn</code> is not asserted, the first data phase is not completed.</p>
8	Wait	<p>Since <code>lm_ldata_xfern</code> and <code>lm_hdata_xfern</code> were not asserted on the previous cycle, the local master keeps Data 3 and Data 4 on <code>l_ad_in[63:0]</code> and the byte enables on <code>lm_cben_in[7:0]</code>.</p> <p>Because the Core needs one more cycle to decide 64-bit or 32-bit transaction, it keeps <code>framen</code> asserted and <code>irdyn</code> de-asserted. It also keeps <code>lm_ldata_xfern</code> and <code>lm_hdata_xfern</code> de-asserted to the local master to signify Data 3 and Data 4 on <code>l_ad_in[63:0]</code> are not read.</p> <p>The Core de-asserts <code>lm_64bit_transn</code> and changes <code>lm_burst_cnt</code> to four to indicate the current data transaction is 32-bit wide. It de-asserts <code>lm_gntn</code> to follow <code>gntn</code>.</p> <p>Since <code>irdyn</code> is not asserted, the first data phase is not completed.</p>

Table 2-24. 32-bit Master Burst Write Transaction With a 64-bit Local Interface (Continued)

CLK	Phase	Description
9	Data 1	<p>Since <code>lm_ldata_xfern</code> and <code>lm_hdata_xfern</code> were not asserted on the previous cycle, the local master keeps Data 3 and Data 4 on <code>l_ad_in[63:0]</code> and the byte enables on <code>lm_cben_in[7:0]</code>.</p> <p>With both <code>devseln</code> and <code>lm_rdyn</code> asserted previous cycle, the master asserts <code>irdyn</code>, and it prepares for the 32-bit write burst.</p> <p>The Core keeps <code>framen</code> asserted. It also keeps <code>lm_ldata_xfern</code> and <code>lm_hdata_xfern</code> de-asserted to the local master to signify Data 3 and Data 4 on <code>l_ad_in[63:0]</code> are not read.</p> <p>Because the Core performs the burst transactions, it keeps <code>framen</code> asserted.</p> <p>Since both <code>irdyn</code> and <code>trdyn</code> are asserted, the first data phase is completed on this cycle.</p>
10	Data 2	<p>Since the previous data phase was completed, the Core decreases '<code>lm_burst_cnt</code>'. Since Data 1 on PCI bus were read by the target, the Core transfers Data 2 and their byte enables to <code>ad[31:0]</code> and <code>cben[3:0]</code>.</p> <p>The Core keeps <code>irdyn</code> asserted.</p> <p>Because <code>trdyn</code> were asserted on the previous cycle, the Core asserts <code>lm_ldata_xfern</code> and de-asserts <code>lm_hdata_xfern</code> to the local master to signify Data 3 on <code>l_ad_in[31:0]</code> and the byte enables on <code>lm_cben_in[3:0]</code> are being read and will be transferred to the PCI bus.</p> <p>The Core keeps <code>framen</code> asserted to the target to signify the burst continues.</p> <p>Since both <code>irdyn</code> and <code>trdyn</code> are asserted, the second data phase is completed on this cycle.</p>
11	Data 3	<p>Since the previous data phase was completed, the Core decreases '<code>lm_burst_cnt</code>'. Since Data 2 on PCI bus was read, the Core transfers Data 3 and its byte enables to <code>ad[31:0]</code> and <code>cben[3:0]</code>. The Core keeps <code>irdyn</code> asserted. Because <code>trdyn</code> was asserted on the previous cycle, the master de-asserts <code>lm_ldata_xfern</code> and asserts <code>lm_hdata_xfern</code> to the local master to signify Data 4 on <code>l_ad_in[63:32]</code> and the byte enables on <code>lm_cben_in[7:4]</code> are being read and will be transferred to the PCI bus. Since both <code>irdyn</code> and <code>trdyn</code> are asserted, the third data phase is completed on this cycle.</p>
11	Data 4	<p>Since the previous data phase was completed, the Core decreases '<code>lm_burst_cnt</code>'. Since Data 3 on PCI bus were read, the Core transfers Data 4 and their byte enables to <code>ad[31:0]</code> and <code>cben[3:0]</code>.</p> <p>The Core keeps <code>irdyn</code> asserted. Because the current transaction is the last, the Core de-asserts <code>framen</code> and <code>req64n</code> to signal the end of the burst, also it de-asserts <code>lm_ldata_xfern</code> and <code>lm_hdata_xfern</code>.</p> <p>Since both <code>irdyn</code> and <code>trdyn</code> are asserted, the fourth data phase is completed on this cycle.</p>
12	Turn around	<p>The Core relinquishes control of <code>framen</code>, <code>req64n</code>, <code>ad</code> and <code>cben</code>. It de-asserts <code>irdyn</code>, decreases '<code>lm_burst_cnt</code>' to zero and changes <code>lm_status[3:0]</code> into 'Bus Termination' with <code>lm_termination</code> as 'Normal Termination' because both <code>trdyn</code> and <code>irdyn</code> were asserted last cycle. The target de-asserts <code>devseln</code> and <code>trdyn</code>.</p>
13	Idle	<p>The Core relinquishes control of <code>irdyn</code>, <code>par</code> and <code>par64</code>.</p>

Dual Address Cycle (DAC)

The PCI IP core application logic issues a Dual Address Cycle (DAC) command to inform the PCI IP core of its usage of 64-bit addressing. In response, the Core executes two back-to-back address phases for the target. The PCI IP core issues DAC to handle memory maps that are larger than the 4GB limitation of the 32-bit memory map. 64-bit addressing is not restricted to only 64-bit configurations of the PCI IP core.

Figure 2-21 shows an example of the DAC during a 32-bit read transaction. Table 2-25 gives a clock-by-clock description of the dual address cycle.

Figure 2-21. Master Dual Address Cycle – Read Transaction

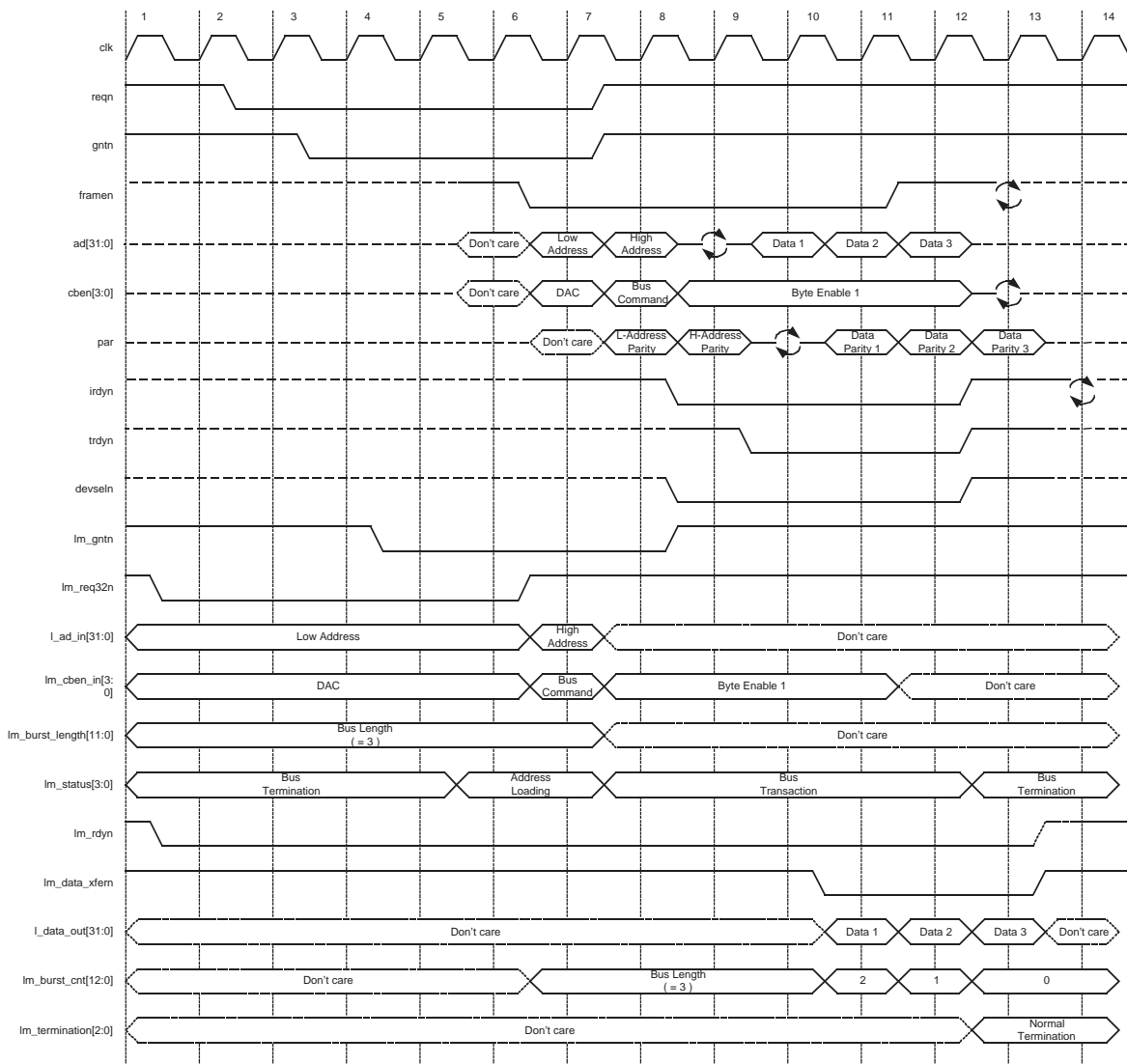

Table 2-25. 32- Bit Dual Address Cycle – Read Transaction

CLK	Phase	Description
1	Idle	The <code>lm_req32n</code> signal is asserted by the local master to request for 32-bit data transaction. The local master issues the PCI lower starting address, the bus command (DAC), and the burst length on the same clock cycle to <code>l_ad_in</code> , <code>lm_cben_in</code> , and <code>lm_burst_length</code> , respectively.
2	Idle	The Core's Local Master Interface detects the asserted <code>lm_req32n</code> and asserts <code>reqn</code> to request the use of PCI bus.
3	Idle	<code>gntn</code> is asserted to grant the Core access to the PCI bus. Core is now the PCI master.
4	Idle	Since <code>gntn</code> is asserted and the bus is idle, the Core starts the bus transactions. The Core asserts <code>lm_gntn</code> to inform the local master that the bus request is granted.
5	Idle	If both <code>lm_req32n</code> and <code>gntn</code> were asserted on the previous cycle, <code>lm_status[3:0]</code> is changed to 'Address Loading' to indicate the lower starting address, the bus command, and the burst length are being latched.

Table 2-25. 32- Bit Dual Address Cycle – Read Transaction (Continued)

CLK	Phase	Description
6	Low Address	<p>The Core asserts <code>framen</code> and the local master de-asserts <code>lm_req32n</code> when the previous <code>lm_status[3:0]</code> was 'Address Loading' and if it doesn't want to request another PCI bus transaction.</p> <p>Since <code>lm_status[3:0]</code> was 'Address Loading' on the previous cycle. It also drives the PCI starting address on <code>ad[31:0]</code> and the PCI command (DAC) on <code>cben[3:0]</code>. On the same cycle, it keeps <code>lm_status[3:0]</code> as 'Address Loading' for the Dual Address Cycle.</p> <p>Local master provides higher address on <code>l_ad_in[31:0]</code>.</p> <p><code>lm_burst_cnt</code> gets the value of the burst length.</p>
7	High Address	<p>The Core de-asserts <code>reqn</code> when <code>framen</code> was asserted but <code>lm_req32n</code> was de-asserted on the previous cycle.</p> <p>The Core keeps <code>framen</code> to start transaction.</p> <p>Since <code>lm_status[3:0]</code> was 'Address Loading' on the previous cycle. It also drives the PCI higher starting address on <code>ad[31:0]</code> and the PCI command on <code>cben[3:0]</code>. On the same cycle, it outputs <code>lm_status[3:0]</code> as 'Bus Transaction' to indicate the beginning of the address/data phases.</p> <p>Because <code>lm_rdyn</code> was asserted on the previous cycle and the next cycle is the first data phase, the local master provides the byte enables on <code>lm_cben_in[3:0]</code>. Asserting <code>lm_rdyn</code> also means the local master is ready to read. If it is not ready to read data, it keep <code>lm_rdyn</code> de-asserted until it is ready.</p>
8	Turn around	<p>The Core de-asserts <code>lm_gntn</code> to follow <code>gntn</code>.</p> <p>The target asserts to indicate it acknowledges the 32-bit transaction.</p> <p>The Core tri-states the <code>ad[63:0]</code> lines and drives the byte enables (Byte Enable 1). Since <code>lm_rdyn</code> was asserted on the previous cycle, it asserts <code>irdyn</code> to indicate it is ready to read data.</p> <p>Because the Core performs the burst transactions, it keeps <code>framen</code> asserted.</p>
9	Data 1	<p>The target asserts <code>trdyn</code> and puts Data 1 on <code>ad[31:0]</code>.</p> <p>With <code>lm_rdyn</code> asserted on the previous cycle, the Core keeps <code>irdyn</code> asserted.</p> <p>The Core keeps <code>framen</code> asserted to the target to signify the burst continues.</p> <p>If the local master is ready to read the first DWORD, it keeps <code>lm_rdyn</code> asserted.</p> <p>Since both <code>irdyn</code> and <code>trdyn</code> are asserted, the first data phase is completed on this cycle.</p>
10	Data 2	<p>Since the previous data phase was completed, the Core transfers Data 1 on <code>l_data_out[31:0]</code> and decreases the <code>lm_burst_cnt</code>.</p> <p>If both <code>trdyn</code> and <code>lm_rdyn</code> were asserted on the previous cycle, the Core asserts <code>lm_data_xfern</code> to the local master to signify Data 1 are available on <code>l_data_out[31:0]</code>. With <code>lm_data_xfern</code> asserted, the local master can safely read Data 1 and increment the address counter.</p> <p>If the local master keeps <code>lm_rdyn</code> asserted on the previous cycle, the master keeps <code>irdyn</code> asserted.</p> <p>The Core keeps <code>framen</code> asserted to the target to signify the burst continues.</p> <p>If the target is still ready to provide data, it keeps <code>trdyn</code> asserted and drives the next DWORD (Data 2) on <code>ad[31:0]</code>.</p> <p>If the local master is ready to read the next DWORD, it keeps <code>lm_rdyn</code> asserted.</p> <p>Since both <code>irdyn</code> and <code>trdyn</code> are asserted, the second data phase is completed on this cycle.</p>

Table 2-25. 32- Bit Dual Address Cycle – Read Transaction (Continued)

CLK	Phase	Description
11	Data 3	<p>Since the previous data phase was completed, the Core transfers Data2 on l_data_out [31:0] and decreases the lm_burst_cnt.</p> <p>If both trdyn and lm_rdyn were asserted on the previous cycle, the master asserts lm_data_xfern to the local master to signify Data 2 are available on l_data_out [31:0]. With lm_data_xfern asserted, the local master can safely read Data 2 and increment the address counter.</p> <p>With lm_rdyn asserted on the previous cycle, the Core keeps irdyn asserted.</p> <p>Because the current transaction is the last, the Core de-asserts framen to signal the end of the burst.</p> <p>If the target is still ready to provide data, it keeps trdyn asserted and drives the next DWORD (Data 3) on ad[31:0].</p> <p>If the local master is ready to read the next DWORD, it keeps lm_rdyn asserted.</p> <p>Since both irdyn and trdyn are asserted, the third data phase is completed in this cycle.</p>
11	Turn around	<p>Since the previous data phase was completed, the Core transfers Data 3 on l_data_out [31:0] and decreases the lm_burst_cnt to zero.</p> <p>The Core relinquishes control of framen and cben. It de-asserts irdyn and changes lm_status [3:0] into 'Bus Termination' with lm_termination as 'Normal Termination' because both trdyn and irdyn were asserted during the last cycle.</p> <p>The target relinquishes control of ad[31:0]. It de-asserts devseln and trdyn.</p> <p>If both trdyn and lm_rdyn were asserted on the previous cycle, the Core asserts lm_data_xfern to the local master to signify Data 3 are available on l_data_out [31:0]. With lm_data_xfern asserted, the local master can safely read Data 3.</p>
12	Idle	<p>The Core relinquishes control of irdyn and de-asserts lm_data_xfern, and the local master de-asserts lm_rdyn since all of the burst data have been read.</p>

Figure 2-22 shows an example of the DAC during a 32-bit write transaction. Table 2-26 gives a clock-by-clock description of the dual address cycle.

Figure 2-22. 32-Bit Master Dual Address Cycle – Write Transaction



Table 2-26. 32-bit Master Dual Address Cycle – Write Transaction

CLK	Phase	Description
1	Idle	The <code>lm_req32n</code> signal is asserted by the local master to request for 32-bit data transaction. The local master issues the PCI starting address, the bus command (DAC), and the burst length during the same clock cycle on <code>l_ad_in</code> , <code>lm_cben_in</code> and <code>lm_burst_length</code> , respectively.
2	Idle	The Core's Local Master Interface detects the asserted <code>lm_req32n</code> and asserts <code>reqn</code> to request the use of PCI bus.
3	Idle	<code>gntn</code> is asserted to grant the Core access to the PCI bus. Core is now the PCI master
4	Idle	Since <code>gntn</code> is asserted and the current bus is idle, the Core is going to start the bus transactions. The Core asserts <code>lm_gntn</code> to inform the local master that the bus request is granted.

Table 2-26. 32-bit Master Dual Address Cycle – Write Transaction (Continued)

CLK	Phase	Description
5	Idle	If both <code>lm_req32n</code> and <code>gntn</code> were asserted on the previous cycle, <code>lm_status[3:0]</code> is changed to 'Address Loading' to indicate the starting address, the bus command and the burst length are being latched.
6	Low Address	<p>The Core asserts <code>framen</code> and the local master de-asserts <code>lm_req32n</code> when the previous <code>lm_status[3:0]</code> was 'Address Loading' and if it doesn't want to request another PCI bus transaction.</p> <p>Since <code>lm_status[3:0]</code> was 'Address Loading' on the previous cycle, it also drives the PCI starting address on <code>ad[31:0]</code> and the PCI command (DAC) on <code>cben[3:0]</code>. On the same cycle, it keeps <code>lm_status[3:0]</code> as 'Address Loading' for the Dual Address Cycle.</p> <p>Local master provides high 32-bit address on <code>l_ad_in[31:0]</code>.</p> <p><code>lm_burst_cnt</code> gets the value of the burst length.</p>
7	High Address	<p>The Core de-asserts <code>reqn</code> when <code>framen</code> was asserted but <code>lm_req32n</code> was de-asserted on the previous cycle.</p> <p>The Core keeps <code>framen</code> to start transaction.</p> <p>Since <code>lm_status[3:0]</code> was 'Address Loading' on the previous cycle, it also drives the PCI higher starting address on <code>ad[31:0]</code> and the PCI command on <code>cben[3:0]</code>. On the same cycle, it outputs <code>lm_status[3:0]</code> as 'Bus Transaction' to indicate the beginning of the address/data phases.</p> <p>Because <code>lm_rdyn</code> was asserted on the previous cycle and the next cycle is the first data phase, the local master should provide Data 1 on <code>l_ad_in[31:0]</code> and the byte enables on <code>lm_cben_in[3:0]</code>. And the Core asserts <code>lm_data_xfern</code> to the local master to signify these data and byte enables are being read and will be transferred to the PCI bus.</p> <p>Asserting <code>lm_rdyn</code> means the local master is ready to write data. If it is not, it should keep <code>lm_rdyn</code> de-asserted until it is ready.</p>
8	Wait	<p>The Core de-asserts <code>reqn</code> when <code>framen</code> was asserted.</p> <p><code>lm_data_xfern</code> is kept asserted to signify Data 2 on <code>l_ad_in[31:0]</code> and the byte enables on <code>lm_cben_in[3:0]</code> are being read and will be transferred to the PCI bus.</p> <p>If the local master is ready to provide the next DWORD, it keeps <code>lm_rdyn</code> asserted.</p>
9	Data 1	<p>The Core keeps <code>framen</code> asserted and asserts <code>irdyn</code>. It also de-asserts <code>lm_data_xfern</code> to the local master to signify Data 3 on <code>l_ad_in[31:0]</code> are not read.</p> <p>If the local master is ready to provide the next DWORD, it keeps <code>lm_rdyn</code> asserted.</p> <p>Because the Core performs the burst transactions, it keeps <code>framen</code> asserted.</p> <p>Since both <code>irdyn</code> and <code>trdyn</code> are asserted, the first data phase is completed on this cycle.</p>
10	Data 2	<p>Since the previous data phase was completed, the Core decreases <code>lm_burst_cnt</code>.</p> <p>Since Data 1 on PCI bus were read by the target, the Core transfers Data 2 and their byte enables to <code>ad[31:0]</code> and <code>cben[3:0]</code>.</p> <p>With <code>lm_rdyn</code> asserted previous cycle, the Core keeps <code>irdyn</code> asserted.</p> <p>Because both <code>lm_rdyn</code> and <code>trdyn</code> were asserted on the previous cycle, the Core asserts <code>lm_data_xfern</code> to signify Data 3 on <code>l_ad_in[31:0]</code> and the byte enables on <code>lm_cben_in[3:0]</code> are being read and will be transferred to the PCI bus.</p> <p>Because Data 3 are the last data, the local master de-asserts <code>lm_rdyn</code>.</p> <p>Since both <code>irdyn</code> and <code>trdyn</code> are asserted, the second data phase is completed on this cycle.</p>

Table 2-26. 32-bit Master Dual Address Cycle – Write Transaction (Continued)

CLK	Phase	Description
11	Data 3	<p>Since the previous data phase was completed, the Core decreases <code>lm_burst_cnt</code>.</p> <p>Since Data 2 on the PCI bus were read, the Core transfers Data 3 and their byte enables to <code>ad[31:0]</code> and <code>cben[3:0]</code>.</p> <p>Because the current transaction is the last, the Core de-asserts <code>framen</code> to signal the end of the burst and it de-asserts <code>lm_data_xfern</code>.</p> <p>Since both <code>irdyn</code> and <code>trdyn</code> are asserted, the third data phase is completed on this cycle.</p>
12	Turn around	The Core relinquishes control of <code>framen</code> , <code>ad</code> and <code>cben</code> . It de-asserts <code>irdyn</code> , decreases <code>lm_burst_cnt</code> to zero and changes <code>lm_status[3:0]</code> into 'Bus Termination' with <code>lm_termination</code> as 'Normal Termination' because both <code>trdyn</code> and <code>irdyn</code> were asserted during the last cycle. The target de-asserts <code>devseln</code> and <code>trdyn</code> .
13	Idle	The Core relinquishes control of <code>irdyn</code> and <code>par</code> .

Fast Back-to-Back Transactions

The PCI IP core, as a master, is capable of executing fast back-to-back transactions if two or more consecutive transactions are required. The fast back-to-back transaction consists of two or more complete PCI transactions without an idle state between them. To execute fast back-to-back transaction with the PCI IP core, `lm_req32n` or `lm_req64n` must be asserted once `lm_status` changes to the 'Address Loading' state. Otherwise, the assertion will not be recognized and the next transaction will be treated as a basic transaction having the 'Idle State' on the PCI bus. An effective way for handling fast back-to-back transfers is to keep `lm_req32n` or `lm_req64n` asserted until required data has been transferred.

For fast back-to-back transaction, the previous transaction must be a write transaction.

[Figure 2-23](#) and [Table 2-27](#) illustrate a 64-bit, fast back-to-back write transaction. The figure illustrates how the PCI interface correlates to the Local Master Interface. The table explains each event in the figure with a clock-by-clock description.

Figure 2-23. 64-bit Master Fast Back-to-Back Transaction

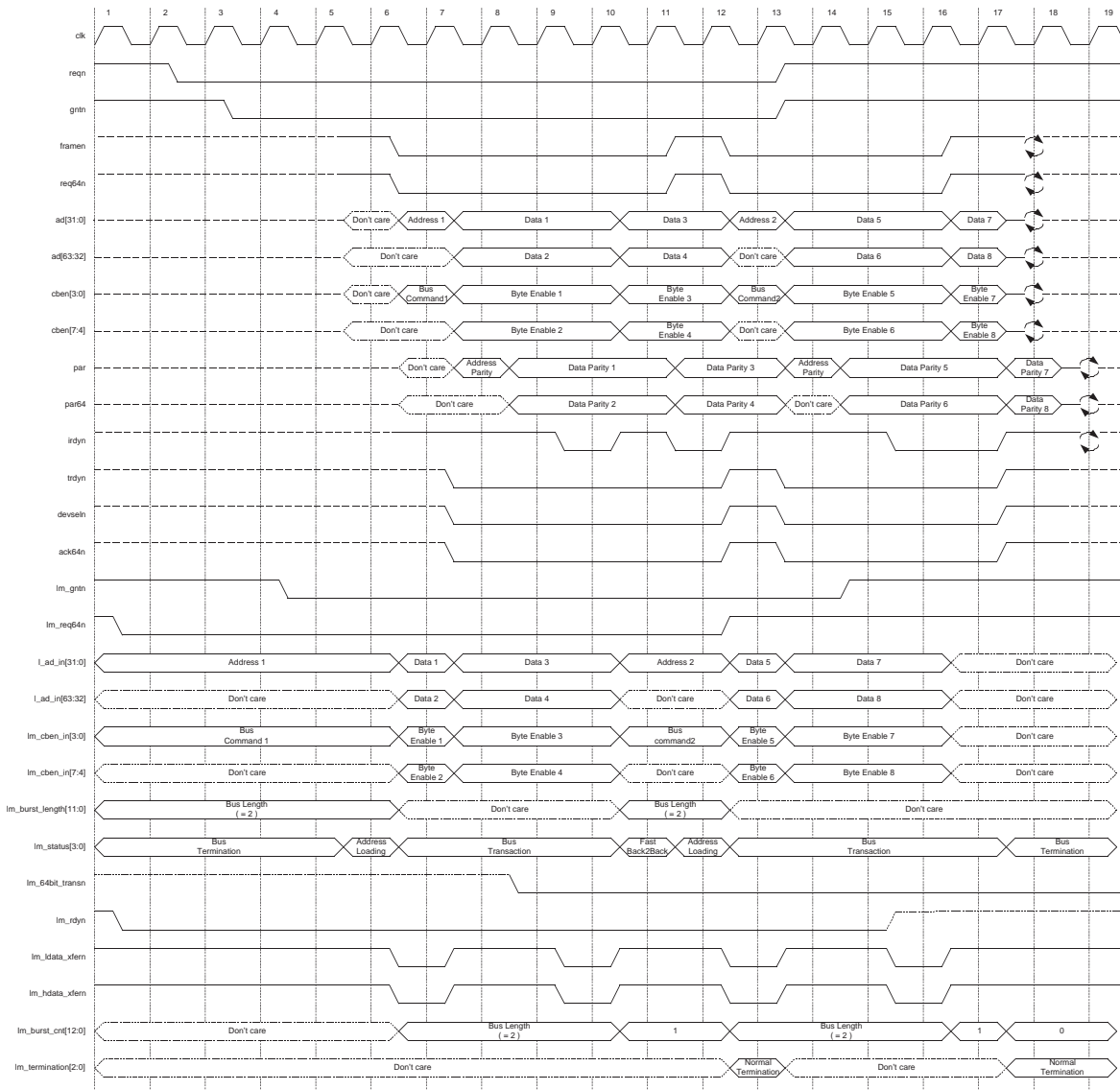

Table 2-27. Fast Back-to-Back Transaction

CLK	PCI Data Phase	Description
1	Idle	The local master asserts <code>lm_req64n</code> to request for 64-bit data transaction. It also issues the PCI starting address, the bus command and the burst length on <code>l_ad_in</code> , <code>lm_cben_in</code> and <code>lm_burst_length</code> respectively during the same clock cycle.
2	Idle	The Core's Local Master Interface detects the asserted <code>lm_req64n</code> and asserts <code>reqn</code> to request the use of PCI bus.
3	Idle	<code>gntn</code> is asserted to grant the Core access to the PCI bus. Core is now PCI master
4	Idle	Since <code>gntn</code> is asserted and the current bus is idle, the Core is going to start the bus transactions. The Core asserts <code>lm_gntn</code> to inform the local master that the bus request is granted.
5	Idle	If both <code>lm_req64n</code> and <code>lm_gntn</code> were asserted on the previous cycle, <code>lm_status[3:0]</code> is changed to 'Address Loading' to indicate the starting address, the bus command and the burst length are being latched.
6	Address	<p>The local master keeps <code>lm_req64n</code> because it wants to request another PCI bus transaction for fast back-to-back transaction.</p> <p>The Core asserts <code>framen</code> and <code>req64n</code> to initiate the 64-bit write transaction when <code>gntn</code> was asserted and <code>lm_status[3:0]</code> was 'Address Loading' on the previous cycle. It also drives the PCI starting address on <code>ad[31:0]</code> and the PCI command on <code>cben[3:0]</code>. On the same cycle, it outputs <code>lm_status[3:0]</code> as 'Bus Transaction' to indicate the beginning of the address/data phases.</p> <p><code>lm_burst_cnt</code> gets the value of the burst length.</p> <p>Because <code>lm_rdyn</code> was asserted on the previous cycle and the next cycle is the first data phase, the local master provides Data 1 and Data 2 on <code>l_ad_in[63:0]</code> and the byte enables on <code>lm_cben_in[7:0]</code>. And the Core asserts <code>lm_ldata_xfern</code> and <code>lm_hdata_xfern</code> to the local master to signify these data and byte enables are being read and will be transferred to the PCI bus.</p> <p>Asserting <code>lm_rdyn</code> means the local master is ready to write data. If it is not, it keeps <code>lm_rdyn</code> de-asserted until it is ready.</p>
7	Wait	<p>The Core keeps <code>reqn</code> when <code>framen</code> and <code>lm_req64n</code> were asserted to indicate fast back-to-back transaction.</p> <p>If the target completes the fast decode and is ready to receive 64-bit data, it asserts <code>devseln</code>, <code>ack64n</code> and <code>trdyn</code>.</p> <p>With <code>lm_ldata_xfern</code> and <code>lm_hdata_xfern</code> asserted on the previous cycle that was the address phase, the local master should increment the address counter while the Core transfers Data 1 and Data 2 and their byte enables to <code>ad[63:0]</code> and <code>cben[7:0]</code>.</p> <p>With <code>lm_rdyn</code> asserted on the previous cycle, the local master provides Data 3 and Data 4 on <code>l_ad_in[63:0]</code> and the byte enables on <code>lm_cben_in[7:0]</code>.</p> <p>Because this is the first write data phase and <code>devseln</code> is just asserted, the Core keeps <code>framen</code> asserted and <code>irdyn</code> de-asserted to judge 64-bit or 32-bit transaction. It also de-asserts <code>lm_ldata_xfern</code> and <code>lm_hdata_xfern</code> to the local master to signify Data 3 and Data 4 on <code>l_ad_in[63:0]</code> are not read.</p> <p>If the local master is ready to provide the next QWORD, it keeps <code>lm_rdyn</code> asserted.</p> <p>Since <code>irdyn</code> is not asserted, the first data phase is not completed.</p>
8	Wait	<p>Since <code>lm_ldata_xfern</code> and <code>lm_hdata_xfern</code> were not asserted on the previous cycle, the local master keeps Data 3 and Data 4 on <code>l_ad_in[63:0]</code> and the byte enables on <code>lm_cben_in[7:0]</code>.</p> <p>Because the Core needs one more cycle to decide 64-bit or 32-bit transaction, it keeps <code>framen</code> asserted and <code>irdyn</code> de-asserted. It also keeps <code>lm_ldata_xfern</code> and <code>lm_hdata_xfern</code> de-asserted to the local master to signify Data 3 and Data 4 on <code>l_ad_in[63:0]</code> are not read.</p> <p>The Core asserts <code>lm_64bit_transn</code> to indicate the current data transaction is 64-bit wide. It de-asserts <code>lm_gntn</code> to follow <code>gntn</code>.</p> <p>If the local master is ready to provide the next QWORD, it keeps <code>lm_rdyn</code> asserted.</p> <p>Since <code>irdyn</code> is not asserted, the first data phase is not completed.</p>

Table 2-27. Fast Back-to-Back Transaction (Continued)

CLK	PCI Data Phase	Description
9	Data 1 and 2	<p>Since <code>lm_ldata_xfern</code> and <code>lm_hdata_xfern</code> were not asserted on the previous cycle, the local master keeps Data 3 and Data 4 on <code>l_ad_in[63:0]</code> and the byte enables on <code>lm_cben_in[7:0]</code>.</p> <p>With both <code>devseln</code> and <code>lm_rdyn</code> asserted previous cycle, the Core asserts <code>irdyn</code>, and it prepares for the 64-bit write burst. So it asserts <code>lm_ldata_xfern</code> and <code>lm_hdata_xfern</code> to the local master to signify Data 3 and Data 4 on <code>l_ad_in[63:0]</code> and the byte enables on <code>lm_cben_in[7:0]</code> are being read and will be transferred to the PCI bus.</p> <p>The Core keeps <code>framen</code> asserted and <code>irdyn</code> de-asserted. It also keeps <code>lm_ldata_xfern</code> and <code>lm_hdata_xfern</code> de-asserted to the local master to signify Data 3 and Data 4 on <code>l_ad_in[63:0]</code> are not read.</p> <p>If the local master is ready to provide the next QWORD, it keeps <code>lm_rdyn</code> asserted. Because the Core performs the burst transactions, it keeps <code>framen</code> asserted.</p> <p>Since both <code>irdyn</code> and <code>trdyn</code> are asserted, the first data phase is completed on this cycle.</p>
10	Wait	<p>Since the previous data phase was completed, the Core decreases '<code>lm_burst_cnt</code>'.</p> <p>At the last data phase of first transaction, the Core inserts a wait cycle to prepare next transaction. So it de-asserts <code>irdyn</code> and changes <code>lm_status[3:0]</code> from 'Bus Transaction' to 'Fast Back2Back', and it also de-asserts <code>lm_ldata_xfern</code> and <code>lm_data_xfern</code>.</p> <p>With <code>lm_ldata_xfern</code> and <code>lm_hdata_xfern</code> asserted on the previous cycle, the local master should put next transaction's address, bus command and burst length on <code>l_ad_in[31:0]</code>, <code>lm_cbe_in[3:0]</code> and <code>lm_burst_length[11:0]</code> respectively.</p> <p>Since Data 1 and Data 2 on PCI bus were read by the target, the Core transfers Data 3 and Data 4 and their byte enables to <code>ad[63:0]</code> and <code>cben[7:0]</code>.</p>
11	Data 3 and 4	<p>The Core de-asserts <code>framen</code> and <code>req64n</code>, asserts <code>irdyn</code> to signal Data 3 and 4 transferred.</p> <p>Since both <code>irdyn</code> and <code>trdyn</code> are asserted, the second data phase is completed on this cycle.</p> <p>If both <code>lm_req64n</code> and <code>lm_gntn</code> were asserted on the previous cycle, <code>lm_status[3:0]</code> is changed to 'Address Loading' to indicate the starting address, the bus command and the burst length are being latched.</p>
12	Address	<p>The local master de-asserts <code>lm_req64n</code> when the previous <code>lm_status[3:0]</code> was 'Address Loading'.</p> <p>The Core asserts <code>framen</code> and <code>req64n</code> to initiate the second 64-bit write transaction when <code>gntn</code> was asserted and <code>lm_status[3:0]</code> was 'Address Loading' on the previous cycle. It also drives the PCI starting address on <code>ad[31:0]</code> and the PCI command on <code>cben[3:0]</code>. On the same cycle, it outputs <code>lm_status[3:0]</code> as 'Bus Transaction' to indicate the beginning of the address/data phases.</p> <p><code>lm_burst_cnt</code> gets the value of the burst length.</p> <p>Because <code>lm_rdyn</code> was asserted on the previous cycle and the next cycle is the first data phase, the local master provides Data 5 and Data 6 on <code>l_ad_in[63:0]</code> and the byte enables on <code>lm_cben_in[7:0]</code>. And the Core asserts <code>lm_ldata_xfern</code> and <code>lm_hdata_xfern</code> to the local master to signify these data and byte enables are being read and will be transferred to the PCI bus.</p> <p>Asserting <code>lm_rdyn</code> means the local master is ready to write data. If it is not, it keeps <code>lm_rdyn</code> de-asserted until it is ready.</p>

Table 2-27. Fast Back-to-Back Transaction (Continued)

CLK	PCI Data Phase	Description
13	Wait	<p>The Core de-asserts reqn when framen was asserted but lm_req64n was de-asserted on the previous cycle.</p> <p>If the target completes the fast decode and is ready to receive 64-bit data, it asserts devseln, ack64n and trdyn.</p> <p>With lm_ldata_xfern and lm_hdata_xfern asserted on the previous cycle that was the address phase, the local master should increment the address counter while the Core transfers Data 5 and Data 6 and their byte enables to ad[63:0] and cben[7:0].</p> <p>With lm_rdyn asserted on the previous cycle, the local master provides Data 7 and Data 8 on l_ad_in[63:0] and the byte enables on lm_cben_in[7:0].</p> <p>Because this is the first write data phase and devseln is just asserted, the Core keeps framen asserted and irdyn de-asserted to judge 64-bit or 32-bit transaction. It also de-asserts lm_ldata_xfern and lm_hdata_xfern to the local master to signify Data 7 and Data 8 on l_ad_in[63:0] are not read.</p> <p>If the local master is ready to provide the next QWORD, it keeps lm_rdyn asserted.</p> <p>Since irdyn is not asserted, the first data phase is not completed.</p>
14	Wait	<p>Since lm_ldata_xfern and lm_hdata_xfern were not asserted on the previous cycle, the local master keeps Data 7 and Data 8 on l_ad_in[63:0] and the byte enables on lm_cben_in[7:0].</p> <p>Because the Core needs one more cycle to decide 64-bit or 32-bit transaction, it keeps framen asserted and irdyn de-asserted. It also keeps lm_ldata_xfern and lm_hdata_xfern de-asserted to the local master to signify Data 7 and Data 8 on l_ad_in[63:0] are not read.</p> <p>The Core asserts lm_64bit_transn to indicate the current data transaction is 64-bit wide. It de-asserts lm_gntn to follow gntn.</p> <p>If the local master is ready to provide the next QWORD, it keeps lm_rdyn asserted.</p> <p>Since irdyn is not asserted, the first data phase is not completed.</p>
15	Data 5 and 6	<p>Since lm_ldata_xfern and lm_hdata_xfern were not asserted on the previous cycle, the local master keeps Data 7 and Data 8 on l_ad_in[63:0] and the byte enables on lm_cben_in[7:0].</p> <p>With both devseln and lm_rdyn asserted previous cycle, the Core asserts irdyn, and it prepares for the 64-bit write burst. So it asserts lm_ldata_xfern and lm_hdata_xfern to the local master to signify Data 7 and Data 8 on l_ad_in[63:0] and the byte enables on lm_cben_in[7:0] are being read and will be transferred to the PCI bus.</p> <p>The Core keeps framen asserted and asserts irdyn. It also keeps lm_ldata_xfern and lm_hdata_xfern de-asserted to the local master to signify Data 3 and Data 4 on l_ad_in[63:0] are not read.</p> <p>If the local master is ready to provide the next QWORD, it keeps lm_rdyn asserted.</p> <p>Because the Core performs the burst transactions, it keeps framen asserted.</p> <p>Since both irdyn and trdyn are asserted, the first data phase is completed on this cycle.</p>
16	Data 7 and 8	<p>Since the previous data phase was completed, the Core decreases 'lm_burst_cnt'.</p> <p>Since Data 5 and Data 6 on PCI bus were read, the Core transfers Data 7 and Data 8 and their byte enables to ad[63:0] and [7:0].</p> <p>With lm_rdyn asserted previous cycle, the Core keeps irdyn asserted.</p> <p>Because the current transaction is the last, the Core de-asserts framen and req64n to signal the end of the burst, also it de-asserts lm_ldata_xfern and lm_hdata_xfern.</p> <p>Since both irdyn and trdyn are asserted, the second data phase is completed on this cycle.</p>
17	Turn around	<p>The Core relinquishes control of framen, req64n, ad and cben. It de-asserts irdyn, decreases 'lm_burst_cnt' to zero and changes lm_status[3:0] into 'Bus Termination' with lm_termination as 'Normal Termination' because both trdyn and irdyn were asserted last cycle. The target de-asserts devseln, ack64n and trdyn.</p>
18	Idle	<p>The Core relinquishes control of irdyn, par and par64.</p>

Master and Target Termination

The signal `lm_termination[2:0]` indicates the different types of Master-initiated terminations. In addition, the state of the target's response when the master executes the transaction is made available for the user's master application. This enables the master application to complete, terminate or refer the transaction to software via interrupt.

The master-initiated early termination commands include timeout and Master Abort. When the master's `gntn` line is de-asserted and its internal latency timer is expired, the master ends the current transaction. When it doesn't detect the assertion of `devseln` within the required period after it asserts `framen`, the master terminates the current transaction. This is called Master Abort termination.

The back-end application monitors and controls early termination of PCI transactions by asserting `lm_abortn`. Any `lm_abortn` assertion is ignored during 'Address Loading' and the first clock cycle of 'Bus Transaction'. If `lm_abortn` is asserted after first clock cycle of 'Bus Transaction', the transaction is terminated at next data phase. When next clock cycle is a wait cycle, the transaction is not terminated until one data phase is completed, except when the target aborts the transaction.

A summary of the four types of target-initiated termination commands are described in [Table 2-28](#).

Table 2-28. Master Initiated Termination Summary

Lm_termination[2:0]	Name	Description
000	Normal termination	Normal Termination takes place.
001	Timeout termination	The cycle timed out.
010	No target response termination	Also known as Master Abort. The Master terminates the transaction because <code>devseln</code> was not asserted during the expected time.
011	Target abort termination	The Target issues an abort termination
100	Retry termination	The target of the transaction is not ready for the transaction. The Master issues a retry.
101	Disconnect data termination	The target device is terminating the burst transaction.
110	Grant abort termination	A Grant termination has occurred.
111	Local master termination	The Local Interface cannot complete the transaction.

Basic PCI Target Read and Write Transactions

Read and write transactions to memory and I/O space are used to transfer data on the PCI bus. The basic read and write transactions use the following PCI commands:

- I/O Read
- I/O Write
- Memory Read
- Memory Write
- Configuration Read
- Configuration Write

To make the integration of the PCI IP core as simple as possible, the basic transactions are described based on different bus configurations supported with this PCI IP core. Although the fundamentals of the basic transactions are the same, different bus configurations require slightly different local bus signaling. The PCI and local bus configurations do not affect configuration access because configuration accesses require no local bus intervention. Refer to the following sections for more information on the basic bus transactions with specific PCI IP core configurations:

- 32-Bit PCI Target with a 32-Bit Local Bus
- 64-Bit PCI Target with a 64-Bit Local Bus
- 32-Bit PCI Target with a 64-Bit Local Bus

Refer to the advanced bus transactions in the Advanced Target Transactions section for more information on proper wait state insertion and early termination of bus transactions by the PCI IP core.

Design Hint: Using the base address registers as memory space and not I/O space in a device is highly recommended. In a legacy PC environment the I/O space is extremely limited and fragmented due to legacy issues.

32-bit PCI Target with a 32-bit Local Bus Memory Transactions

This section discusses read and write transactions for the PCI IP core, operating as a Target, configured with a 32-bit PCI bus and a 32-bit local bus. Because 32-bit I/O and memory transactions are alike, they are discussed together.

[Figure 2-24](#) illustrates an example of a basic 32-bit read transaction. [Table 2-29](#) gives a clock-by-clock description of the basic 32-bit transaction in [Figure 2-24](#). On a read transaction it is important to realize and understand the latency between the PCI and Local Target Interface. For instance, two clock cycles of latency exist between `lt_rdyn` and `trdyn`.

Figure 2-24. 32-bit Target Single Read Transaction with a 32-bit Local Interface



Table 2-29. 32-bit Target Single Read Transaction with a 32-Bit Local Interface

CLK	PCI Data Phase	Description
1	Address	The master asserts <code>framen</code> and drives <code>ad[31:0]</code> and <code>cben[3:0]</code> .
2	Turn around	The master tri-states the <code>ad[31:0]</code> lines and drives the byte enables <code>cben[3:0]</code> . If the master is ready to receive single data, it asserts <code>irdyn</code> and de-asserts <code>framen</code> to indicate single data phase transaction. The PCI IP core starts to decode the address and command. It also registers and drives the <code>lt_address_out</code> <code>lt_command_out</code> to the back end.
3	Wait	If there is an address match, the Core drives the <code>bar_hit</code> signals to the back-end. It also asserts <code>lt_accessn</code> . The back-end can use the <code>bar_hit</code> signals as a chip select.
4	Wait	With the device select timing set to Slow, the Core asserts <code>devseln</code> one clock after <code>bar_hit</code> . If the back-end is ready to put data out on the next cycle, it can assert <code>lt_rdyn</code> . The local target can insert wait states by not asserting <code>lt_rdyn</code> .
5	Wait	The Core's Local Target Interface asserts <code>lt_data_xfern</code> since <code>lt_rdyn</code> was asserted the previous cycle. The back end drives the first DWORD (Data 1) on <code>l_ad_in[31:0]</code> . The Core asserts <code>lt_data_xfern</code> to indicate that data from the back-end logic must be valid at this time in order for the master to read the data correctly.
6	Data 1	With <code>lt_rdyn</code> asserted during the previous two cycles the Core asserts <code>trdyn</code> and puts Data 1 on <code>ad[31:0]</code> .
7	Turn around	The master relinquishes control of <code>framen</code> and <code>cben[3:0]</code> and de-asserts <code>irdyn</code> since the data transfer only requires one data phase. The Core relinquishes control of <code>ad[31:0]</code> and de-asserts both <code>devseln</code> and <code>trdyn</code> .
8	Idle	The Core relinquishes control of <code>devseln</code> and <code>trdyn</code> . The Core also clears <code>bar_hit</code> , to signal to the back end that the transaction is complete, and de-asserts <code>lt_data_xfern</code> .

Figure 2-25 illustrates an example of a basic 32-bit write transaction to the PCI IP core operating as a Target. Table 2-30 gives a clock-by-clock description of the 32-bit write transaction.

Figure 2-25. 32-bit Target Single Write Transaction with a 32-bit Local Interface



Table 2-30. 32-bit Target Single Write Transaction with a 32-bit Local Interface

CLK	PCI Data Phase	Description
1	Address	The master asserts <code>framen</code> and drives <code>ad[31:0]</code> and <code>cben[3:0]</code> .
2	Wait	The master drives the byte enable (Byte Enable 1). The master asserts <code>irdyn</code> , indicating that it is ready to write the data, and de-asserts <code>framen</code> . To indicate a single data phase transaction, it drives DWORD (Data 1) on <code>ad[31:0]</code> . The Core starts to decode the address and command and drives the <code>lt_address_out</code> to the back-end.
3	Wait	If an address match is present, the Core drives the <code>bar_hit</code> signals to the back-end. The back-end can use <code>bar_hit</code> as a chip select.
4	Wait	With the <code>DEVSEL_TIMING</code> set to slow, the Core asserts <code>devseln</code> one clock after <code>bar_hit</code> . If the back-end will be ready to write data in two cycles, it can assert <code>lt_rdyn</code> .
5	Data 1	<code>trdyn</code> is asserted by the Core since <code>lt_rdyn</code> was asserted by the application logic during the previous cycle.
6	Turn around	If both <code>irdyn</code> and <code>trdyn</code> were asserted on the previous cycle, the master relinquishes control of <code>framen</code> , <code>ad[31:0]</code> and <code>cben[3:0]</code> . The master also de-asserts <code>irdyn</code> since only one data phase is required. The Core asserts <code>lt_data_xfern</code> to indicate that the valid PCI data is available for writing.
7	Idle	The Core relinquishes control of <code>devseln</code> and <code>trdyn</code> . The target clears <code>bar_hit</code> to signal to the back-end that the transaction is complete. It also de-asserts <code>lt_data_xfern</code> .

64-Bit PCI Target with a 64-Bit Local Bus

This section discusses read and write transactions for a PCI IP core, operating as a target, configured with a 64-bit PCI bus and a 64-bit local bus. All 64-bit PCI devices are required by the PCI Specification to handle both 64-bit and 32-bit applications. The 32-bit transactions, described in the 32-Bit PCI Target with a 32-Bit Local Bus Memory Transactions section, are similar to a 32-bit transaction for the 64-bit PCI IP core configuration with the exception that when the 64-bit Core responds to a 32-bit transaction the upper 32 bits of the data bus should be ignored.

The 64-bit memory read transaction is similar to the 32-bit target read transaction with additional PCI signals required for 64-bit signaling. Figure 2-27 and Table 2-31 illustrate a basic 64-bit read transaction.

Figure 2-26. 64-Bit Target Single Read Transaction with a 64-Bit Local Interface



Table 2-31. 64-bit Target Single Read Transaction with a 64-bit Local Interface

CLK	PCI Data Phase	Description
1	Address	The master asserts <code>framen</code> , <code>req64n</code> and drives <code>ad[31:0]</code> and <code>cben[3:0]</code> .
2	Turn around	The master tri-states the <code>ad[63:0]</code> lines and drives the first byte enables (Byte Enable 1 and 2). If the master is ready to receive data, it asserts <code>irdyn</code> . The Core starts to decode the address and command. The Core drives the <code>lt_address_out</code> to the back-end. The <code>lt_64bit_transn</code> signal is driven low to signal the back-end that a 64-bit transaction has been requested.
3	Wait	If an address match is present, the Core drives the <code>bar_hit</code> signals to the back-end. The back-end can use the <code>bar_hit</code> as a chip select.
4	Wait	If the <code>DEVSEL_TIMING</code> is set to slow, the Core asserts <code>devseln</code> one clock after <code>bar_hit</code> . The <code>ack64n</code> signal is also asserted to acknowledge the 64-bit request. If the back-end is ready to put data out on the next cycle, it can assert <code>lt_rdyn</code> .
5	Wait	The local target asserts <code>lt_hdata_xfern</code> and <code>lt_ldata_xfern</code> since <code>lt_rdyn</code> was asserted the previous cycle. The back-end drives the first QWORD (Data 1) on <code>l_ad_in[63:0]</code> . With <code>lt_rdyn</code> asserted during the previous two cycles, the burst cycle starts the Core asserts <code>trdyn</code> and puts Data 1 on <code>ad[31:0]</code> .
6	Data 1	With <code>lt_rdyn</code> asserted previous two cycles, the burst cycle starts. The Core asserts <code>trdyn</code> and puts Data 1 on <code>ad[63:0]</code> . If both <code>irdyn</code> and <code>lt_rdyn</code> are asserted on the previous cycle, the Core keeps <code>lt_hdata_xfern</code> and <code>lt_ldata_xfern</code> asserted to the back-end. The back-end can increment the address counter and put the next QWORD (Don't care) on <code>l_ad_in[63:0]</code> .
9	Turn around	The master relinquishes control of <code>framen</code> , <code>ack64n</code> and <code>cben[7:0]</code> . It de-asserts <code>irdyn</code> if both <code>trdyn</code> and <code>irdyn</code> were asserted last cycle. The Core relinquishes control of <code>ad[63:0]</code> . It de-asserts both <code>devseln</code> and <code>trdyn</code> if both <code>trdyn</code> and <code>irdyn</code> were asserted during the last cycle. The Core also clears <code>bar_hit</code> to signal to the back-end that the transaction is complete. The Core de-asserts <code>lt_hdata_xfern</code> and <code>lt_ldata_xfern</code> .
10	Idle	

The 64-bit memory write transaction is similar to the 32-bit target write transaction with additional PCI signals required for 64-bit signaling. [Figure 2-27](#) and [Table 2-31](#) show a basic 64-bit write transaction.

Figure 2-27. 64-bit Target Single Write Transaction with a 64-bit Local Interface



Table 2-32. 64-bit Target Single Write Transaction with a 64-bit Local Interface

CLK	PCI Data Phase	Description
1	Address	The master asserts <code>framen</code> and <code>req64n</code> and drives <code>ad[63:0]</code> and <code>cben[3:0]</code> .
2	Wait	The master drives the first byte enables (Byte Enable 1). If the master is ready to write data, it asserts <code>irdyn</code> and drives the first QWORD (Data 1) on <code>ad[63:0]</code> . The Core starts to decode the address and command. The Core drives the <code>lt_address_out</code> to the back-end. The <code>lt_64bit_transn</code> signal is driven low to signal the back-end that a 64-bit transaction has been requested.
3	Wait	If there is an address match, the Core drives the <code>bar_hit</code> signals to the back-end. The back-end can use the <code>bar_hit</code> as a chip select.
4	Wait	If the <code>DEVSEL_TIMING</code> is set to slow, the Core asserts <code>devseln</code> on clock after <code>bar_hit</code> . The <code>ack64n</code> signal is also asserted to acknowledge the 64-bit request. If the back-end will be ready to put data out on the next cycle, it can assert <code>lt_rdyn</code> .
5	Data 1	<code>trdyn</code> is asserted since <code>lt_rdyn</code> was asserted during the previous cycle.
6	Turn around	If both <code>irdyn</code> and <code>trdyn</code> are asserted during the previous cycle, the master relinquishes control of <code>framen</code> , <code>req64n</code> , <code>ad[63:0]</code> and <code>cben[7:0]</code> . It also de-asserts <code>irdyn</code> if both <code>trdyn</code> and <code>irdyn</code> were asserted last cycle.
7	Idle	The Core signals to the back-end that the transaction is complete by clearing <code>bar_hit</code> . It also de-asserts <code>lt_hdata_xfern</code> and <code>lt_ldata_xfern</code> .
8	Idle	

32-Bit PCI Target with a 64-Bit Local Bus

This section discusses read and write transactions for a PCI IP core, operating as a target, configured with a 32-bit PCI bus and a 64-bit local bus. The 32-bit PCI transactions, described in the 32-Bit PCI Target with a 32-Bit Local Bus Memory Transactions section, look similar to the transaction; however, the data is handled differently at the Local Target Interface.

In order to present a full 64 bits of data to the Local Target Interface, two PCI data phase are required. Like retrieving 64 bits of data from the Local Target Interface, two PCI data phases are required

The Local Target Interface control latches the complete QWORD and routes the proper DWORD to the PCI data bus. The `lt_ldata_xfern` and `lt_hdata_xfern` signals specify which DWORD is transferred.

If the starting address is QWORD aligned, the first DWORD is assumed to be the lower DWORD of a QWORD and is placed on the PCI data bus. Otherwise, the upper DWORD is placed on the PCI data bus.

The 64-bit memory write transaction is similar to the 32-bit target write transaction with additional PCI signals required for 64-bit signaling. [Figure 2-28](#) and [Table 2-33](#) illustrate a basic 64-bit write transaction.

Figure 2-28. 32-bit Target Single Read Transaction with a 64-bit Local Interface



Table 2-33. 32-bit Target Single Read Transaction with a 64-bit Local Interface

CLK	PCI Data Phase	Description
1	Address	The master asserts <code>framen</code> and drives <code>ad[31:0]</code> and <code>cben[3:0]</code> .
2	Turn around	The master tri-states the <code>ad</code> lines and drives the first byte enables (Byte Enable 1). If the master is ready to receive data, it asserts <code>irdyn</code> . The Core starts to decode the address and command. The Core drives the <code>lt_address_out</code> to the back-end.
3	Wait	If there is an address match, the Core drives the <code>bar_hit</code> signals to the back-end. The back-end can use the <code>bar_hit</code> as a chip select.
4	Wait	If the <code>DEVSEL_TIMING</code> is set to slow, the Core asserts <code>devseln</code> on clock after <code>bar_hit</code> . If the back-end will be ready to put data out on the next cycle, it can assert <code>lt_rdyn</code> .
5	Wait	<u>Quad Word Aligned</u> With <code>lt_rdyn</code> asserted on the previous cycle, the local interface asserts <code>lt_ldata_xfern</code> . The back-end drives the first DWORD (Data 1) on <code>l_ad_in[31:0]</code> . <u>Double Word Aligned</u> With <code>lt_rdyn</code> asserted on the previous cycle, the local interface asserts <code>lt_hdata_xfern</code> . The back-end drives the first DWORD (Data 1) on <code>l_ad_in[63:32]</code> .
6	Data 1	With <code>trdyn</code> and <code>irdyn</code> asserted Data 1 is placed on <code>ad[31:0]</code> . <u>Quad Word Aligned</u> The Core de-asserts <code>lt_ldata_xfern</code> . If <code>irdyn</code> is asserted on the previous cycle, the Core asserts <code>lt_hdata_xfern</code> to the back-end. With <code>lt_hdata_xfern</code> de-asserted the previous cycle, the back-end does not increment the address counter and holds the QWORD (Data 2) on <code>l_ad_in[63:0]</code> . <u>Double Word Aligned</u> With <code>lt_rdyn</code> asserted during the previous two cycles, the burst cycle starts, so the Core asserts <code>trdyn</code> and puts Data 1 on <code>ad</code> since the initial address is DWORD aligned. Notice that the lower DWORD from <code>l_ad_in[31:0]</code> is discarded. The Core de-asserts <code>lt_hdata_xfern</code> . If both <code>irdyn</code> and <code>lt_rdyn</code> are asserted on the previous cycle, the Core asserts <code>lt_ldata_xfern</code> to the back-end. With <code>lt_hdata_xfern</code> asserted the previous cycle, the back-end can increment the address counter and put the next QWORD (Data 2) on <code>l_ad_in[31:0]</code> .
7	Data 2	The Core keeps <code>trdyn</code> asserted and puts Data 2 on <code>ad[31:0]</code> .
8	Turn around	The master relinquishes control of <code>framen</code> and <code>cben[3:0]</code> . It de-asserts <code>irdyn</code> if both <code>trdyn</code> and <code>irdyn</code> were asserted last cycle. The Core relinquishes control of <code>ad[31:0]</code> . It de-asserts both <code>devseln</code> and <code>trdyn</code> if both <code>trdyn</code> and <code>irdyn</code> were asserted last cycle.
9	Idle	The Core relinquishes control of <code>devseln</code> and <code>trdyn</code> . The Core also signals to the back-end that the transaction is complete by clearing <code>bar_hit</code> . The Core de-asserts <code>lt_data_xfern</code> .

The 64-bit memory write transaction is very similar to the 32-bit target write transaction with additional PCI signals required for 64-bit signaling. [Figure 2-29](#) and [Table 2-34](#) show a basic 64-bit write transaction.

Figure 2-29. 32-bit Target Single Write Transaction with a 64-bit Local Interface



Table 2-34. 32-bit Target Single Write Transaction with a 64-bit Local Interface

CLK	PCI Data Phase	Description
1	Address	The master asserts <code>framen</code> and drives <code>ad[31:0]</code> and <code>cben[3:0]</code> .
2	Wait	The master drives the first byte enables (Byte Enable 1). If the master is ready to write data, it asserts <code>irdyn</code> and drives the first DWORD (Data 1) on <code>ad[31:0]</code> . The Core starts to decode the address and command. The Core drives the <code>lt_address_out</code> and <code>lt_command_out</code> to the back-end.
3	Wait	If there is an address match, the Core drives the <code>bar_hit</code> signals to the back-end. The back-end can use the <code>bar_hit</code> as a chip select.
4	Wait	If the <code>DEVSEL_TIMING</code> is set to slow, the Core asserts <code>devseln</code> on clock after <code>bar_hit</code> . If the back-end will be ready to write data in two cycles, it can assert <code>lt_rdyn</code> .
5	Data 1	<code>trdyn</code> is asserted since <code>lt_rdyn</code> was asserted the previous cycle.
6	Data 2	<u>Quad Word Aligned</u> The Core keeps <code>trdyn</code> asserted and puts Data 1 on the lower DWORD of <code>lt_data_out</code> . If both <code>irdyn</code> and <code>trdyn</code> are asserted on the previous cycle, the master drives the next byte enables (Byte Enable 2) on <code>cben[3:0]</code> . If the PCI master is still ready to write data, it keeps <code>irdyn</code> asserted and drives the next DWORD (Data 2) on <code>ad[31:0]</code> . If both <code>irdyn</code> and <code>trdyn</code> were asserted on the previous cycle, the Core asserts <code>lt_ldata_xfern</code> to the back-end to signify that Data 1 is valid. With <code>lt_ldata_xfern</code> asserted, the back-end doesn't write the data or increment the address counter. <u>Double Word Aligned</u> The Core keeps <code>trdyn</code> asserted and puts Data 1 on the upper DWORD of <code>lt_data_out</code> . If both <code>irdyn</code> and <code>trdyn</code> are asserted on the previous cycle, the master drives the next byte enables (Byte Enable 2) on <code>cben[3:0]</code> . If the master is still ready to write data, it keeps <code>irdyn</code> asserted and drives the next DWORD (Data 2) on <code>ad[31:0]</code> . If <code>irdyn</code> , <code>trdyn</code> and <code>lt_rdyn</code> are asserted on the previous cycle, the Core asserts <code>lt_hdata_xfern</code> to the back-end to signify that Data 1 is valid. With <code>lt_hdata_xfern</code> asserted, the back-end can safely write the QWORD (Don't care and Data 1) and increment the address counter.
7	Turn around	If both <code>irdyn</code> and <code>trdyn</code> are asserted on the previous cycle, the master relinquishes control of <code>framen</code> , <code>ad[31:0]</code> and <code>cben[3:0]</code> . It also de-asserts <code>irdyn</code> if both <code>trdyn</code> and <code>irdyn</code> were asserted last cycle. It de-asserts both <code>devseln</code> and <code>trdyn</code> if both <code>trdyn</code> and <code>irdyn</code> were asserted last cycle.
8	Idle	The Core relinquishes control of <code>devseln</code> and <code>trdyn</code> . The target signals to the back-end that the transaction is complete by clearing <code>bar_hit</code> . It also de-asserts <code>lt_data_xfern</code> .

Configuration Read and Write Transactions

The PCI IP core handles configuration transactions from addresses 00h to 40h. The Local Target Interface has no control of these types of accesses and is independent of these transactions. However, these transactions are still provided for verification purposes.

The PCI IP core only supports 32-bit, single data phase transactions to configuration registers. An individual `idsel` signal is connected to each PCI IP core device. Otherwise, read and write transactions are like the standard memory and I/O transactions. [Figure 2-30](#) and [Table 2-35](#) illustrate an example of a configuration read. [Figure 2-31](#) and [Table 2-36](#) shows an example of a configuration write.

The Capabilities List accesses and other configuration accesses over address 40h are beyond the PCI IP core's ability to complete the transaction without intervention from the Local Target Interface. Therefore, accesses to memory locations over address 40h are treated as local accesses and handled by the local target interface control. These configuration accesses are discussed further in [Advanced Configuration Accesses](#) section.

Figure 2-30. Basic Configuration Read



Table 2-35. Basic Configuration Read

CLK	PCI Bus Phase	Description
1	Address	The master asserts <code>framen</code> and <code>idsel</code> . It drives the configuration address and Configuration Read command. The configuration address is <code>ad[1:0] = 00</code> (type zero access); <code>ad[7:2] = configuration DWORD address</code> ; <code>ad[10:8] = function number</code> ; and <code>ad[31:11] = unused</code> .
2	Turn around	The master tri-states <code>ad[31:0]</code> and drives the first byte enable (Byte Enable 1). If the master is ready to receive data, it asserts <code>irdyn</code> . The Core starts to decode the address and command.
3	Wait	The address decode continues.
4	Wait	If the <code>devsel_timing</code> is set to slow, the Core asserts <code>devseln</code> . The Core is ready to put data out on the next cycle.
5	Data 1	The data cycle starts as the target Core <code>trdyn</code> and puts Data 1 on <code>ad</code> . The Core also asserts <code>stopn</code> to ensure the configuration transaction is single data phase.
6	Turn around	The master relinquishes control of <code>framen</code> and <code>cben[3:0]</code> . It de-asserts <code>irdyn</code> if both <code>trdyn</code> and <code>irdyn</code> were asserted during the last cycle. The Core relinquishes control of <code>ad[31:0]</code> . It de-asserts both <code>devseln</code> , <code>trdyn</code> and <code>stopn</code> if both <code>trdyn</code> and <code>irdyn</code> were asserted during the last cycle.
7	Idle	The Core relinquishes control of <code>devseln</code> , <code>trdyn</code> and <code>stopn</code> .

Figure 2-31. Basic Configuration Write

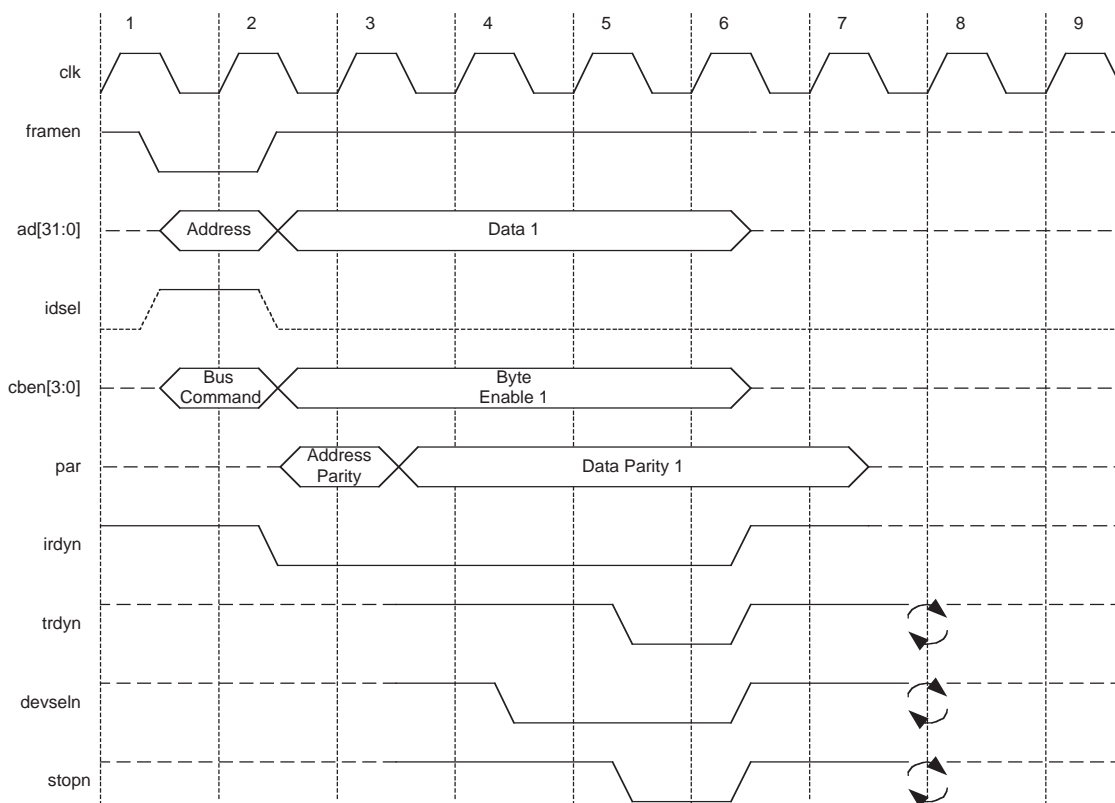

Table 2-36. Basic Configuration Write

CLK	PCI Bus Phase	Description
1	Address	The master asserts <i>framen</i> and <i>idsel</i> . It drives the configuration address and configuration write command. The configuration address is $ad[1:0] = 00$ (type zero access); $ad[7:2] =$ (Configuration DWORD address); $ad[10:8] =$ (function number); $ad[31:11] =$ unused.
2	Wait	The master drives the first byte enables (Byte Enable 1). If the bridge is ready to write data, it asserts <i>irdyn</i> and drives the first DWORD (Data 1) on $ad[31:0]$. The master signals the last data phase when it de-asserts <i>framen</i> . The Core starts to decode the address and command.
3	Wait	The address decode continues.
4	Wait	If the <i>DEVSEL_TIMING</i> is set to slow, the Core asserts <i>devseln</i> . The Core should be ready to get the data on the next cycle.
5	Data	The <i>trdyn</i> signal is asserted and the Core writes the DWORD. The Core also asserts <i>stopn</i> to ensure the configuring transaction is single data phase.
6	Turn around	The master relinquishes control of <i>framen</i> , $ad[31:0]$ and <i>cben[3:0]</i> . It de-asserts <i>irdyn</i> if both <i>trdyn</i> and <i>irdyn</i> were asserted last cycle. The Core de-asserts <i>devseln</i> , <i>trdyn</i> and <i>stopn</i> if both <i>trdyn</i> and <i>irdyn</i> were asserted last cycle.
7	Idle	The Core relinquishes control of <i>devseln</i> , <i>trdyn</i> and <i>stopn</i> .

PCI Target I/O Read and Write Transactions

Designing a PCI target application using I/O space is not recommended for several reasons. They include legacy device conflicts, and full address and byte enable decoding for all I/O locations. However, the PCI IP core does support I/O space. Transactions to I/O locations are similar to the basic memory transactions discussed in the Basic PCI Target Read and Write Transactions section.

In legacy systems, I/O space is limited. The system generally uses I/O space for vital system components such as interrupt controllers. These system components are spread throughout the I/O space, leaving only small gaps for additional devices that require I/O space. If I/O space is used in a legacy system, it is limited to 256 bytes.

By definition, read and write transactions to I/O space can only be completed using 32-bit PCI transactions. Decoding all 32 bits in the address and determining which byte enables (`cben[3:0]`) are supported is necessary. The back-end application responds with a target abort if any unsupported byte enable combinations are requested.

Advanced Target Transactions

Some PCI applications require more than basic read and write transactions. For these applications, the *PCI Local Bus Specification, Revision 3.0* offers advanced features to handle the more difficult aspects of the PCI bus. The advanced features are used to provide the PCI application with more flexibility and improve the overall PCI system performance. The following sections offer more detail on these advanced PCI bus features.

Wait States

Care must be taken when processing wait states to be compliant with the *PCI Local Bus Specification, Revision 3.0*. Once a PCI master or a PCI target signals that it is ready to send or receive data, it must complete the current PCI data phase. For example, if the PCI IP core is ready to write data and the PCI master inserts wait states, the PCI IP core must wait to write the data until the master is ready again. Additionally, if the PCI IP core has committed to a data phase by asserting `trdyn`, it can not insert any wait states until the next data phase. Coincident master and target wait state insertion is also a possibility. Refer to the PCI Specification for more information regarding coincident wait state insertion.

Two types of wait states that can occur on the PCI bus. The first is master wait state insertion. When the PCI master inserts wait states, the PCI IP core must hold off data until the PCI master is ready. The PCI IP core inserts the second type of wait states. The back-end application controls the PCI IP core's wait state insertion via the Local Target Interface.

[Figure 2-32](#) and [Table 2-37](#) illustrate master-inserted and target-inserted wait states for read transactions. The figure illustrates how the PCI interface correlates to the Local Target Interface. The table gives a clock-by-clock description of each event in the figure.

Figure 2-32. 32-bit Target Read Transaction with Master Wait State



Table 2-37. 32-bit Target Read Transaction with Master Wait State

CLK	PCI Data Phase	Description
1	Address	The PCI master asserts <i>framen</i> and drives <i>ad[31:0]</i> and <i>cben[3:0]</i> .
2	Turn around	The PCI master tri-states <i>ad[31:0]</i> . The PCI master is ready to receive data. It asserts <i>irdyn</i> .
3	Target Wait	The Core starts to decode the address and command.
4	Target Wait	If the <i>DEVSEL_TIMING</i> is set to slow, the Core asserts <i>devseln</i> one clock after <i>bar_hit</i> . <i>trdyn</i> is kept asserted since the back-end logic did not assert <i>lt_rdyn</i> during clock cycle 3. The back-end logic asserts <i>lt_rdyn</i> during this cycle.
5	Target Wait	The PCI IP core inserts a wait state as it has not yet asserted the <i>trdyn</i> signal. Since both <i>irdyn</i> and <i>lt_rdyn</i> were asserted on the previous cycle, the Core asserts <i>lt_data_xfern</i> .
6	Data 1	The Core asserts <i>trdyn</i> and drives Data 1 from the local target on to the PCI <i>ad[31:0]</i> bus. If the PCI master is still ready to receive data, it keeps <i>irdyn</i> asserted and drives the next byte enables (Byte Enables) on <i>cben[3:0]</i> . If the back-end kept <i>lt_rdyn</i> asserted in the previous two cycles, the Core keeps <i>trdyn</i> asserted and puts Data 2 on <i>ad[31:0]</i> . If both <i>irdyn</i> and <i>lt_rdyn</i> are asserted on the previous cycle, the Core re-asserts <i>lt_data_xfern</i> to the back-end.
7	Master Wait	The PCI master is not ready to receive data, it de-asserts <i>irdyn</i> . If the back-end keeps <i>lt_rdyn</i> asserted previous two cycles, the Core keeps <i>trdyn</i> asserted and puts Data 2 on <i>ad[31:0]</i> . If both <i>irdyn</i> and <i>lt_rdyn</i> are asserted on the previous cycle, the Core re-asserts <i>lt_data_xfern</i> to the back-end. The back-end should increment the address counter.

Table 2-37. 32-bit Target Read Transaction with Master Wait State (Continued)

CLK	PCI Data Phase	Description
8	Data 2	If the PCI master is ready to receive data, it asserts <i>irdyn</i> and drives the next byte enables (Byte Enable 3) on <i>cben</i> [3:0]. Because <i>irdyn</i> is not asserted on the previous cycle, the Core de-asserts <i>lt_data_xfern</i> on the local interface.
9	Data 3	Since the last data phase, the master asserts <i>irdyn</i> and de-asserts <i>framen</i> . If both <i>irdyn</i> and <i>lt_rdyn</i> are asserted on the previous cycle, the Core re-asserts <i>lt_data_xfern</i> to the back-end.
10	Turn around	The master relinquishes control of <i>framen</i> , <i>ad</i> [31:0] and <i>cben</i> [3:0]. The Core de-asserts both <i>devseln</i> and <i>trdyn</i> .
11	Idle	The Core relinquishes control of <i>devseln</i> and <i>trdyn</i> .

Figure 2-33 and Table 2-38 show master-inserted and target-inserted wait states that are inserted on write transactions. The figure illustrates how the PCI interface correlates to the Local Target Interface. The table gives a clock-by-clock description of each event in the figure.

Figure 2-33. 32-bit Target Write Transaction with Master Wait State



Table 2-38. 32-bit Target Write Transaction with Master Wait State

CLK	PCI Data Phase	Description
1	Address	The master asserts <code>framen</code> and drives <code>ad[31:0]</code> and <code>cben[3:0]</code> .
2	Target Wait	The PCI master is ready to receive data. It asserts <code>irdyn</code> .
3	Target Wait	The Core starts to decode the address and command.
4	Target Wait	If the <code>DEVSEL_TIMING</code> is set to slow, the target asserts <code>devseln</code> on clock after <code>bar_hit</code> . The <code>lt_rdyn</code> signal is driven low to indicate that the back-end application is ready to receive data.
5	Data 1	The <code>irdyn</code> and <code>trdyn</code> signals are asserted Data 1 is registered from <code>ad[31:0]</code> .
6	Master Wait	With <code>lt_data_xfern</code> signal asserted Data1 is registered on <code>lt_data_out[31:0]</code> . The master is not ready to receive data. It inserts a wait state by de-asserting <code>irdyn</code> . The master holds Data 1 on the <code>ad[31:0]</code> lines and continues to drive the first byte enables (Byte Enable 1).
7	Data 2	With the <code>irdyn</code> signal asserted Data 2 is driven on to <code>ad[31:0]</code> . Because <code>irdyn</code> is not asserted on the previous cycle, the Core de-asserts <code>lt_data_xfern</code> on the local interface.
8	Data 3	With the <code>irdyn</code> signal asserted Data 3 is driven on to <code>ad[31:0]</code> . If both <code>irdyn</code> and <code>lt_rdyn</code> are asserted on the previous cycle, the Core re-asserts <code>lt_data_xfern</code> to the back-end.
9	Turn around	With <code>lt_data_xfern</code> signal asserted Data 2 is registered on <code>lt_data_out[31:0]</code> . The master relinquishes control of <code>framen</code> , <code>ad[31:0]</code> and <code>cben[3:0]</code> . The Core de-asserts both <code>devseln</code> and <code>trdyn</code> if both <code>trdyn</code> and <code>irdyn</code> were asserted last cycle.
10	Idle	The Core relinquishes control of <code>devseln</code> and <code>trdyn</code> .

Burst Read and Write Target Transactions

Burst read and write transactions to memory addresses are used to achieve the high throughput that is typically associated with the PCI bus. The following lists the commands for the PCI IP core that support bursting.

- Memory Read
- Memory Write
- Memory Read Multiple
- Dual Address Cycle
- Memory Read Line
- Memory Write and Invalidate

These PCI burst transactions are described based on the different PCI and Local bus configurations supported by the PCI IP core. Although the fundamentals of bursting are similar for all PCI IP core configurations, different bus configurations require slightly different Local Target Interface signaling. The PCI IP core does not support bursting for Configuration Space or I/O space accesses. Refer to the following sections for more information on bursting with specific PCI Target configurations:

- 32-Bit PCI Target with a 32-Bit Local Bus
- 64-Bit PCI Target with a 64-Bit Local Bus
- 32-Bit PCI Target with a 64-Bit Local Bus

Typically for burst transactions, the PCI master and the PCI target has a predefined number of PCI data phases that are to be transferred. The PCI master will know the number of data phases that are to be transferred based on the software driver and specifications that were defined by the PCI IP core's implementation. The PCI IP core will have a predefined number of data phases based on the design requirements of the PCI Target core's application. The design requirements include items like FIFO depth and the general ability to handle throughput. Handling these requirements is covered in more detail in the *PCI Local Bus Specification, Revision 3.0*.

32-Bit PCI Bus and a 32-Bit Local Bus

The following section discusses read and write, burst transactions for a PCI IP core configured with a 32-bit PCI bus and a 32-bit Local bus. Figure 2-34 and Table 2-39 show a 32-bit burst read transaction. The figure illustrates how the PCI interface correlates to the Local Target Interface. The table gives a clock-by-clock description of each event that occurs in the figure.

Figure 2-34. 32-bit Target Burst Read Transaction with a 32-bit Local Interface



Table 2-39. 32-bit Target Burst Read Transaction with a 32-bit Local Interface

CLK	PCI Data Phase	Description
1	Address	The PCI master asserts <i>framen</i> and drives <i>ad[31:0]</i> and <i>cben[3:0]</i> .
2	Turn around	The PCI master tri-states <i>ad[31:0]</i> and drives the first byte enables (Byte Enable 1) on <i>cben[3:0]</i> . If the PCI master is ready to receive data, it asserts <i>irdyn</i> . The Core starts to decode the address and command and drives the <i>lt_address_out</i> to the back-end application.
3	Wait	If there is an address match, the Core drives the <i>bar_hit</i> signals to the back-end. The back-end can use the <i>bar_hit</i> as a chip select.

Table 2-39. 32-bit Target Burst Read Transaction with a 32-bit Local Interface (Continued)

CLK	PCI Data Phase	Description
4	Wait	If the DEVSEL_TIMING is set to slow, the Core asserts <code>devseln</code> on clock after <code>bar_hit</code> . If the back-end will be ready to put data out on the next cycle, it can assert <code>lt_rdyn</code> .
5	Wait	The Core asserts <code>lt_data_xfern</code> since <code>lt_rdyn</code> was asserted the previous cycle. The back-end drives the first DWORD (Data 1) on <code>l_ad_in</code> .
6	Data 1	With <code>lt_rdyn</code> asserted for the previous two cycles, the burst cycle starts, so the Core asserts <code>trdyn</code> and puts Data 1 on <code>ad[31:0]</code> . If both <code>irdyn</code> and <code>lt_rdyn</code> are asserted on the previous cycle, the target keeps <code>lt_data_xfern</code> asserted to the back-end. The back-end can increment the address counter and put the next DWORD (Data 2) on <code>l_ad_in</code> .
7	Data 2	If the PCI master is still ready to receive data, it keeps <code>irdyn</code> asserted and drives the next byte enables (Byte Enable 2) on <code>cben[3:0]</code> . If the back-end keeps <code>lt_rdyn</code> asserted for the previous two cycles, the Core keeps <code>trdyn</code> asserted and puts Data 2 on <code>ad[31:0]</code> . If both <code>irdyn</code> and <code>lt_rdyn</code> are asserted on the previous cycle, the Core keeps <code>lt_data_xfern</code> asserted to the back-end. The back-end can increment the address counter and put the next DWORD (Data 3) on <code>l_ad_in</code> .
8	Data 3	If the PCI master is still ready to receive data, it keeps <code>irdyn</code> asserted and drives the next byte enables (Byte Enable 3) on <code>cben[3:0]</code> . The master signals the end of the burst when it de-asserts <code>framen</code> . If the back-end keeps <code>lt_rdyn</code> asserted previous two cycles, the Core keeps <code>trdyn</code> asserted and puts Data 3 on <code>ad[31:0]</code> . If both <code>irdyn</code> and <code>lt_rdyn</code> are asserted on the previous cycle, the Core keeps <code>lt_data_xfern</code> asserted to the back-end application. The back-end can increment the address counter and put the next DWORD (Don't care) on <code>l_ad_in</code> .
9	Turn around	The master relinquishes control of <code>framen</code> and <code>cben[3:0]</code> . It de-asserts <code>irdyn</code> if both <code>trdyn</code> and <code>irdyn</code> were asserted last cycle. The Core relinquishes control of <code>ad[31:0]</code> . It de-asserts both <code>devseln</code> and <code>trdyn</code> if both <code>trdyn</code> and <code>irdyn</code> were asserted last cycle. The Core also signals to the back-end that the transaction is complete by clearing <code>bar_hit</code> . The Core de-asserts <code>lt_data_xfern</code> .
10	Idle	The Core relinquishes control of <code>devseln</code> and <code>trdyn</code> .

Figure 2-35 and Table 2-40 show an example of a 32-bit burst write transaction. The assumption is that the device select timing is set to slow and wait states are not inserted. The figure illustrates how the PCI interface correlates to the Local Target Interface. The table gives a clock-by-clock description of each event that occurs in the figure.

Figure 2-35. 32-bit Target Burst Write Transaction with a 32-bit Local Interface



Table 2-40. 32-bit Target Burst Write Transaction with a 32-bit Local Interface

CLK	PCI Data Phase	Description
1	Address	The PCI master asserts <code>framen</code> and drives <code>ad[31:0]</code> and <code>cben[3:0]</code> .
2	Wait	The PCI master drives the first byte enables (Byte Enable 1) on <code>cben[3:0]</code> . If the master is ready to write data, it asserts <code>irdyn</code> and drives the first DWORD (Data 1) on <code>ad[31:0]</code> . The PCI IP core starts to decode the address and command and drives the <code>lt_address_out</code> to the back-end.
3	Wait	If there is an address match, the Core drives the <code>bar_hit</code> signals on the Local Interface. The back-end can use the <code>bar_hit</code> as a chip select.
4	Wait	If the <code>DEVSEL_TIMING</code> is set to slow, the Core asserts <code>devseln</code> on clock after <code>bar_hit</code> . If the back-end will be ready to write data in two cycles, it can assert <code>lt_rdyn</code> .
5	Data 1	<code>trdyn</code> is asserted since <code>lt_rdyn</code> was asserted the previous cycle.
6	Data 2	If the back-end keeps <code>lt_rdyn</code> asserted for the previous cycle, the Core keeps <code>trdyn</code> asserted and puts Data 1 on <code>l_data_out</code> . If both <code>irdyn</code> and <code>trdyn</code> are asserted on the previous cycle, the master drives the next byte enables (Byte Enable 2) on <code>cben[3:0]</code> . If the master is still ready to write data, it keeps <code>irdyn</code> asserted and drives the next DWORD (Data 2) on <code>ad[31:0]</code> . If both <code>irdyn</code> and <code>lt_rdyn</code> are asserted on the previous cycle, the Core asserts <code>lt_data_xfern</code> to the back-end to signify Data 1 was transferred successfully. With <code>lt_data_xfern</code> asserted, the back-end can safely write Data 1 and increment the address counter.
7	Data 3	If the back-end keeps <code>lt_rdyn</code> asserted for the previous cycle, the Core keeps <code>trdyn</code> asserted and puts Data 2 on <code>l_data_out</code> . If both <code>irdyn</code> and <code>trdyn</code> are asserted on the previous cycle, the master drives the next byte enables (Byte Enable 3) on <code>cben[3:0]</code> . If the master is still ready to write data, it keeps <code>irdyn</code> asserted and drives the next DWORD (Data 3) on <code>ad[31:0]</code> . The master signals the end of the burst when it de-asserts <code>framen</code> . If both <code>irdyn</code> and <code>lt_rdyn</code> are asserted on the previous cycle, the Core keeps <code>lt_data_xfern</code> asserted to the back-end to signify Data 2 was transferred successfully.
8	Turn around	If the back-end keeps <code>lt_rdyn</code> asserted for the previous cycle, the Core puts Data 3 on <code>l_data_out</code> . If both <code>irdyn</code> and <code>trdyn</code> are asserted on the previous cycle, the master relinquishes control of <code>framen</code> , <code>ad</code> and <code>cben</code> . It also de-asserts <code>irdyn</code> if both <code>trdyn</code> and <code>irdyn</code> were asserted last cycle. If both <code>irdyn</code> and <code>lt_rdyn</code> are asserted on the previous cycle, the Core keeps <code>lt_data_xfern</code> asserted to the back-end to signify Data 3 was transferred successfully. With <code>lt_data_xfern</code> asserted the back-end can safely write Data 3 and increment the address counter. The PCI IP core de-asserts both <code>devseln</code> and <code>trdyn</code> if both <code>trdyn</code> and <code>irdyn</code> were asserted last cycle.
9	Idle	The target signals to the back-end that the transaction is complete by clearing <code>bar_hit</code> . It also de-asserts <code>lt_data_xfern</code> . The Core relinquishes control of <code>devseln</code> and <code>trdyn</code> .

64-Bit PCI Target with a 64-Bit Local Bus

The following discusses read and write burst transactions for the PCI IP core configured with a 64-bit PCI bus and a 64-bit local bus. [Figure 2-36](#) and [Table 2-41](#) illustrate a 64-bit burst write transaction. The figure shows how the PCI interface correlates to the local interface. The table gives a clock-by-clock description of each event that occurs in the figure.

The 32-bit burst transaction, as described in the 32-Bit PCI Bus and a 32-Bit Local Bus section, is similar to a 32-bit burst transaction for the 64-bit PCI IP core configuration. When the 64-bit target core responds to a 32-bit burst transaction, the upper 32 bits of the data bus should be ignored.

Figure 2-36. 64-bit Target Burst Read Transaction with a 64-bit Local Interface

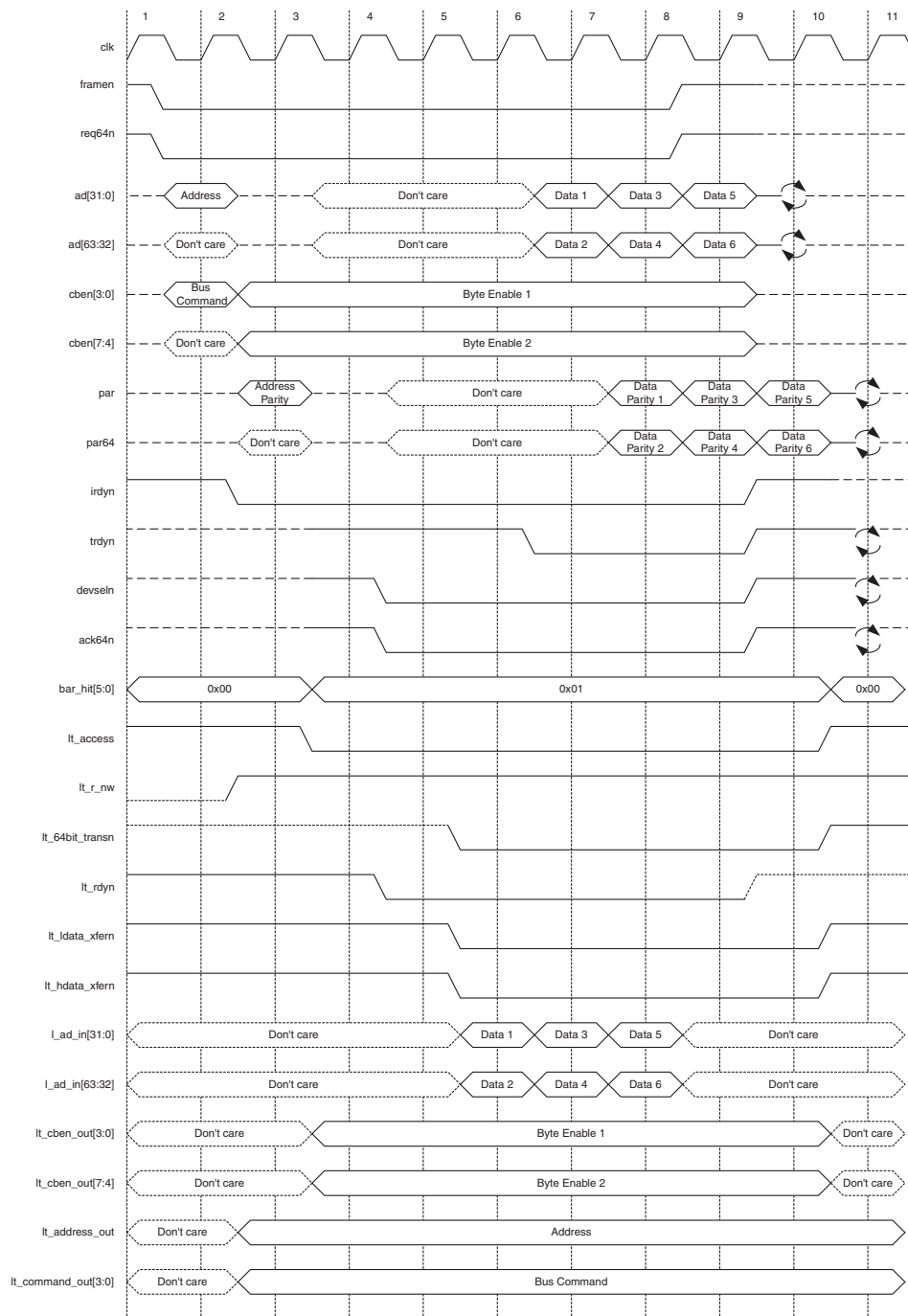

Table 2-41. 64-bit Target Burst Read Transaction with a 64-bit Local Interface

CLK	PCI Data Phase	Description
1	Address	The PCI master asserts <code>framen</code> and drives <code>ad[31:0]</code> and <code>cben[3:0]</code> . It requests a 64-bit transaction by asserting <code>req64n</code> with <code>framen</code> .
2	Turn around	The master tri-states <code>ad[63:0]</code> and drives the first byte enables (Byte Enable 1 and 2) <code>cben[7:0]</code> . If the PCI master is ready to receive data, it asserts <code>irdyn</code> . The Core starts to decode the address and command. The target drives the <code>lt_address_out</code> to the back-end. The <code>lt_64bit_trans</code> signal is driven high to signal the back-end that a 64-bit transaction has been requested.
3	Wait	If there is an address match, the Core drives the <code>bar_hit</code> signals to the Local Interface. The back-end application can use the <code>bar_hit</code> as a chip select.
4	Wait	If the <code>DEVSEL_TIMING</code> is set to slow, the PCI IP core asserts <code>devseln</code> and <code>ack64n</code> on clock after <code>bar_hit</code> . If the back-end will be ready to put data out on the next cycle, it can assert <code>lt_rdyn</code> . The Core acknowledges the 64-bit transaction by asserting <code>ack64n</code> .
5	Wait	The PCI IP core asserts <code>lt_ldata_xfern</code> and <code>lt_hdata_xfern</code> since <code>lt_rdyn</code> was asserted the previous cycle. The back-end drives the first QWORD (Data 1 and 2) on <code>l_ad_in</code> .
6	Data 1 and 2	With <code>lt_rdyn</code> asserted previous two cycles, the burst cycle starts, so the Core asserts <code>trdyn</code> and puts (Data 1 and 2) on <code>ad[63:0]</code> . If both <code>irdyn</code> and <code>lt_rdyn</code> are asserted on the previous cycle, the Core keeps <code>lt_ldata_xfern</code> and <code>lt_hdata_xfern</code> asserted to the back-end. The back-end can increment the address counter and put the next QWORD (Data 3 and 4) on <code>l_ad_in</code> .
7	Data 3 and 4	If the master is still ready to receive data, it keeps <code>irdyn</code> asserted and drives the next byte enables (Byte Enable 3 and 4) on <code>cben[7:0]</code> . If the back-end keeps <code>lt_rdyn</code> asserted previous two cycles, the PCI IP core keeps <code>trdyn</code> asserted and puts (Data 3 and 4) on <code>ad[63:0]</code> . If both <code>irdyn</code> and <code>lt_rdyn</code> are asserted on the previous cycle, the Core keeps <code>lt_ldata_xfern</code> and <code>lt_hdata_xfern</code> asserted. The back-end application can increment the address counter and put the next QWORD (Data 5 and 6) on <code>l_ad_in</code> .
8	Data 5 and 6	If the PCI master is still ready to receive data, it keeps <code>irdyn</code> asserted and drives the next byte enables (Byte Enable 5 and 6) on <code>cben[7:0]</code> . The PCI master signals the end of the burst when it de-asserts <code>framen</code> and <code>req64n</code> . If the back-end application keeps <code>lt_rdyn</code> asserted for the previous two cycles, the Core keeps <code>trdyn</code> asserted and puts Data 5 and 6 on <code>ad[63:0]</code> . If both <code>irdyn</code> and <code>lt_rdyn</code> are asserted on the previous cycle, the Core keeps <code>lt_ldata_xfern</code> and <code>lt_hdata_xfern</code> asserted. The back-end application can increment the address counter and put the next QWORD (Don't care) on <code>l_ad_in</code> .
9	Turn around	The master relinquishes control of <code>framen</code> , <code>req64n</code> and <code>cben[7:0]</code> . It de-asserts <code>irdyn</code> if both <code>trdyn</code> and <code>irdyn</code> were asserted last cycle. The Core relinquishes control of <code>ad[63:0]</code> . It de-asserts <code>devseln</code> , <code>ack64n</code> and <code>trdyn</code> if both <code>trdyn</code> and <code>irdyn</code> were asserted last cycle. The Core also signals to the back-end that the transaction is complete by clearing <code>bar_hit</code> . The target de-asserts <code>lt_ldata_xfern</code> and <code>lt_hdata_xfern</code> .
10	Idle	The Core relinquishes control of <code>devseln</code> , <code>ack64n</code> and <code>trdyn</code> .

Figure 2-37 and Table 2-42 illustrate a 64-bit burst write transaction. The figure shows how the PCI interface correlates to the Local Interface. The table gives a clock-by-clock description of each event that occurs in the figure.

Figure 2-37. 64-bit Target Burst Write Transaction with a 64-bit Local Interface



Table 2-42. 64-bit Target Burst Write Transaction with a 64-bit Local Interface

CLK	PCI Data Phase	Description
1	Address	The PCI master asserts <code>framen</code> and drives <code>ad[31:0]</code> and <code>cben[3:0]</code> . It requests a 64-bit transaction by asserting <code>req64n</code> with <code>framen</code> .
2	Wait	The PCI master drives the first byte enables (Byte Enable 1 and 2) on <code>cben[7:0]</code> . If the PCI master is ready to write data, it asserts <code>irdyn</code> and drives the first QWORD (Data 1 and 2) on <code>ad[63:0]</code> . The Core starts to decode the address and command. The target drives <code>lt_address_out</code> to the back-end. The <code>lt_64bit_trans</code> signal is driven high to signal the back-end application that a 64-bit transaction has been requested.
3	Wait	If there is an address match, the Core drives the <code>bar_hit</code> signals to the back-end application. It can use <code>bar_hit</code> as a chip select.
4	Wait	If the <code>DEVSEL_TIMING</code> is set to slow, the Core asserts <code>devseln</code> on the clock after <code>bar_hit</code> . If the back-end is ready to write data in two cycles it can assert <code>lt_rdyn</code> . The PCI IP core acknowledges the 64-bit transaction by asserting <code>ack64n</code> .
5	Data 1 and 2	The <code>trdyn</code> signal is asserted since <code>lt_rdyn</code> was asserted on the previous cycle.
6	Data 3 and 4	If the back-end keeps <code>lt_rdyn</code> asserted on the previous cycle, the Core keeps <code>trdyn</code> asserted and puts Data 1 and 2 on <code>lt_data_out</code> . If both <code>irdyn</code> and <code>trdyn</code> are asserted on the previous cycle, the master drives the next byte enables (Byte Enable 3 and 4) on <code>cben[7:0]</code> . If the PCI master is still ready to write data, it keeps <code>irdyn</code> asserted and drives the next QWORD (Data 3 and 4) on <code>ad[63:0]</code> . If both <code>irdyn</code> and <code>lt_rdyn</code> are asserted on the previous cycle, the Core asserts <code>lt_ldata_xfern</code> and <code>lt_hdata_xfern</code> to the back-end to signify Data 1 and 2 is valid. With <code>lt_ldata_xfern</code> and <code>lt_hdata_xfern</code> asserted the back-end can safely write Data 1 and 2 and increment the address counter.
7	Data 5 and 6	If the back-end keeps <code>lt_rdyn</code> asserted on the previous cycle, the Core keeps <code>trdyn</code> asserted and puts Data 3 and 4 on <code>lt_data_out</code> . If both <code>irdyn</code> and <code>trdyn</code> are asserted on the previous cycle, the PCI master drives the next byte enables (Byte Enable 5 and 6) on <code>cben[7:0]</code> . If it is still ready to write data, it keeps <code>irdyn</code> asserted and drives the next QWORD (Data 5 and 6) on <code>ad[63:0]</code> . The master signals the end of the burst when it de-asserts <code>framen</code> and <code>req64n</code> . If both <code>irdyn</code> and <code>lt_rdyn</code> are asserted on the previous cycle, the Core keeps <code>lt_ldata_xfern</code> and <code>lt_hdata_xfern</code> asserted to the back-end to signify Data 3 and 4 is valid. With <code>lt_ldata_xfern</code> and <code>lt_hdata_xfern</code> asserted the back-end can safely write Data 3 and 4 and increment the address counter. There is no signal yet to the back-end that the burst is over.
8	Turn around	If the back-end keeps <code>lt_rdyn</code> asserted the previous cycle, the target puts Data 5 and 6 on <code>lt_data_out</code> . If both <code>irdyn</code> and <code>trdyn</code> are asserted on the previous cycle, the master relinquishes control of <code>framen</code> , <code>req64n</code> , <code>ad[63:0]</code> and <code>cben[7:0]</code> . It also de-asserts <code>irdyn</code> if both <code>trdyn</code> and <code>irdyn</code> were asserted on the last cycle. If both <code>irdyn</code> and <code>lt_rdyn</code> were asserted on the previous cycle, the target keeps <code>lt_ldata_xfern</code> and <code>lt_hdata_xfern</code> asserted to the back-end to signify Data 5 and 6 is valid. With <code>lt_ldata_xfern</code> and <code>lt_hdata_xfern</code> asserted the back-end can safely write Data 5 and 6 and increment the address counter. It de-asserts <code>devseln</code> , <code>ack64n</code> and <code>trdyn</code> if both <code>trdyn</code> and <code>irdyn</code> were asserted last cycle.
9	Idle	The Core signals to the back-end that the transaction is complete by clearing <code>bar_hit</code> . It also de-asserts <code>lt_ldata_xfern</code> and <code>lt_hdata_xfern</code> . The target relinquishes control of <code>devseln</code> , <code>ack46n</code> and <code>trdyn</code> .

32-Bit PCI Target with a 64-bit Local Bus

The following discusses read and write transactions for a PCI IP core configured with a 32-bit PCI bus and a 64-bit local bus. In order to present a full 64 bits of data to the Local Interface, two PCI data phase are required. Likewise retrieving 64 bits of data from the Local Interface, two PCI data phases are required.

The 32-bit PCI transaction, as described in the 32-Bit PCI Bus and 32-Bit Local Bus section, looks similar to these transactions; however, the data is handled differently at the Local Interface. When the 32-bit target core responds to a 32-bit burst transaction, the upper 32 bits of the Local data bus should be ignored or return 0's.

With a 64-bit back-end, it is assumed that the address counter needs to increment only by a Quad Word (QWORD) (8 bytes), so the local back-end control latches the complete QWORD and routes the proper DWORD to the PCI data bus. The `lt_ldata_xfern` and `lt_hdata_xfern` signals specify which DWORD is transferred.

If the starting address is QWORD aligned, the first DWORD is assumed to be the lower DWORD of a QWORD. Otherwise, it is the upper DWORD. If the starting address is not QWORD aligned, it must be DWORD aligned.

Figure 2-38 and Table 2-43 illustrate a burst transaction to a 32-bit PCI IP core with a 64-bit Local Interface. The figure illustrates how the PCI interface correlates to the Local Interface. The table gives a clock-by-clock description of each event in the figure.

Figure 2-38. 32-bit Target Burst Read Transaction with a 64-bit Local Interface



Table 2-43. 32-bit Target Burst Read Transaction with a 64-bit Local Interface

CLK	PCI Data Phase	Description
1	Address	The master asserts <code>framen</code> and drives <code>ad[31:0]</code> and <code>cben[3:0]</code> .
2	Turn around	The master tri-states <code>ad[31:0]</code> and drives the first byte enables (Byte Enable 1) on <code>cben[3:0]</code> . If the master is ready to receive data, it asserts <code>irdyn</code> . The Core starts to decode the address and command. It drives the <code>lt_address_out</code> to the back-end.
3	Wait	If there is an address match, the Core drives the <code>bar_hit</code> signals to the back-end. The back-end can use <code>bar_hit</code> as a chip select.
4	Wait	If the <code>DEVSEL_TIMING</code> is set to slow, the Core asserts <code>devseln</code> on the clock following <code>bar_hit</code> . If the back-end application is ready to put data out on the next cycle, it asserts <code>lt_rdyn</code> .
5	Wait	The Core asserts <code>lt_ldata_xfern</code> since <code>lt_rdyn</code> was asserted on the previous cycle and the initial address is QWORD aligned. The back-end drives the first QWORD (Data 1 and Data 2) on <code>l_ad_in</code> .
6	Data 1	<p><u>Quad Word Aligned</u></p> <p>With <code>lt_rdyn</code> asserted for the previous two cycles, the burst cycle starts. The PCI IP core asserts <code>trdyn</code> and puts Data 1 on <code>ad[31:0]</code>.</p> <p>The Core de-asserts <code>lt_ldata_xfern</code>. If <code>irdyn</code> is asserted on the previous cycle, the Core asserts <code>lt_hdata_xfern</code> to the back-end. With <code>lt_hdata_xfern</code> de-asserted the previous cycle, the back-end does not increment the address counter and holds the QWORD (Data 1 and Data 2) on <code>l_ad_in</code>.</p> <p><u>Double Word Aligned</u></p> <p>With <code>lt_rdyn</code> asserted for the previous two cycles, the burst cycle starts, so the Core asserts <code>trdyn</code> and puts Data 1 on <code>ad</code> since the initial address is DWORD aligned. Notice that the lower DWORD from <code>l_ad_in</code> is discarded.</p> <p>The Core de-asserts <code>lt_hdata_xfern</code>. If both <code>irdyn</code> and <code>lt_rdyn</code> are asserted on the previous cycle, the Core asserts <code>lt_ldata_xfern</code> to the back-end. With <code>lt_hdata_xfern</code> asserted the previous cycle, the back-end can increment the address counter and put the next QWORD (Data 2 and Data 3) on <code>l_ad_in</code>.</p>
7	Data 2	<p><u>Quad Word Aligned</u></p> <p>If the master is still ready to receive data, it keeps <code>irdyn</code> asserted and drives the next byte enables. The Core keeps <code>trdyn</code> asserted and puts Data 2 on and loads the appropriate byte enables.</p> <p>The Core de-asserts <code>lt_hdata_xfern</code>. If both <code>irdyn</code> and <code>lt_rdyn</code> are asserted on the previous cycle, the Core asserts <code>lt_ldata_xfern</code> to the back-end. With <code>lt_hdata_xfern</code> asserted the previous cycle, the back-end can increment the address counter and put the next QWORD (Data 3 and Data 4) on <code>l_ad_in</code>.</p> <p><u>Double Word Aligned</u></p> <p>If the master is still ready to receive data, it keeps <code>irdyn</code> asserted and drives the next byte enables on <code>cben[3:0]</code>.</p> <p>If the back-end keeps <code>lt_rdyn</code> asserted previous two cycles, the Core keeps <code>trdyn</code> asserted and puts Data 2 on <code>ad[31:0]</code>. If the master is still ready to receive data, it keeps <code>irdyn</code> asserted and drives the byte enables on <code>cben[3:0]</code>.</p> <p>The Core de-asserts <code>lt_ldata_xfern</code>. If <code>irdyn</code> is asserted on the previous cycle, the Core asserts <code>lt_hdata_xfern</code> to the back-end. With <code>lt_hdata_xfern</code> de-asserted on the previous cycle, the back-end does not increment the address counter and holds the QWORD (Data 2 and Data 3) on <code>l_ad_in</code>.</p>

Table 2-43. 32-bit Target Burst Read Transaction with a 64-bit Local Interface (Continued)

CLK	PCI Data Phase	Description
8	Data 3	<p><u>Quad Word Aligned</u></p> <p>If the PCI master is still ready to receive data, it keeps <code>irdyn</code> asserted and drives the next byte enables (Byte Enable 3) on <code>cben[3:0]</code>. It signals the end of the burst when it de-asserts <code>framen</code>.</p> <p>If the back-end keeps <code>lt_rdyn</code> asserted for the previous two cycles, the Core keeps <code>trdyn</code> asserted and puts Data 3 on <code>ad[31:0]</code>.</p> <p>The Core de-asserts <code>lt_ldata_xfern</code>. If <code>irdyn</code> is asserted on the previous cycle, the Core asserts <code>lt_hdata_xfern</code> to the back-end. With <code>lt_hdata_xfern</code> de-asserted on the previous cycle, the back-end does not increment the address counter and holds the QWORD (Data 3 and Data 4) on <code>l_ad_in</code>.</p> <p><u>Double Word Aligned</u></p> <p>If the master is still ready to receive data, it keeps <code>irdyn</code> asserted and drives the next byte enables (Byte Enable 3) on <code>cben[3:0]</code>. It signals the end of the burst when it de-asserts <code>framen</code>.</p> <p>The Core keeps <code>trdyn</code> asserted and puts Data 3 on <code>ad[31:0]</code> since it latched it with Data 2.</p> <p>The Core de-asserts <code>lt_hdata_xfern</code>. If both <code>irdyn</code> and <code>lt_rdyn</code> are asserted on the previous cycle, the Core asserts <code>lt_ldata_xfern</code> to the back-end. With <code>lt_hdata_xfern</code> asserted on the previous cycle, the back-end can increment the address counter and put the next QWORD (Don't care and Don't care) on <code>l_ad_in</code>.</p>
9	Turn around	<p>The master relinquishes control of <code>framen</code> and <code>cben[3:0]</code>. It de-asserts <code>irdyn</code> if both <code>trdyn</code> and <code>irdyn</code> were asserted for the last cycle.</p> <p>The PCI IP core relinquishes control of <code>ad[31:0]</code>. It de-asserts both <code>devseln</code> and <code>trdyn</code>. If both <code>trdyn</code> and <code>irdyn</code> were asserted last cycle, the PCI IP core also signals to the back-end application that the transaction is complete by clearing <code>bar_hit</code>. The target de-asserts <code>lt_hdata_xfern</code>.</p>
10	Idle	The Core relinquishes control of <code>devseln</code> and <code>trdyn</code> .

Figure 2-39 and Table 2-44 illustrate a burst transaction to a 32-bit PCI IP core with a 64-bit Local Interface. The figure shows how the PCI interface correlates to the Local Interface. The table gives a clock-by-clock description of each event illustrated in the figure.

Figure 2-39. 32-bit Target Burst Write Transaction With a 64-bit Local Interface



Table 2-44. 32-bit Target Burst Write Transaction With a 64-bit Local Interface

CLK	PCI Data Phase	Description
1	Address	The master asserts <code>framen</code> and drives <code>ad[31:0]</code> and <code>cben[3:0]</code> .
2	Wait	The PCI master drives the first byte enable (Byte Enable 1) on <code>cben[3:0]</code> . If it is ready to write data, it asserts <code>irdyn</code> and drives the first DWORD (Data 1) on <code>ad[31:0]</code> . The Core starts to decode the address and command. It drives the <code>lt_address_out</code> to the back-end.
3	Wait	If there is an address match, the Core drives the <code>bar_hit</code> signals to the back-end application. The back-end can use <code>bar_hit</code> as a chip select.
4	Wait	If the <code>DEVSEL_TIMING</code> is set to slow, the Core asserts <code>devseln</code> on the clock after <code>bar_hit</code> . If the back-end will be ready to write data in two cycles, it can assert <code>lt_rdyn</code> .
5	Data 1	<code>trdyn</code> is asserted since <code>lt_rdyn</code> was asserted the previous cycle.
6	Data 2	<p><u>Quad Word Aligned</u></p> <p>The Core keeps <code>trdyn</code> asserted and puts Data 1 on the lower DWORD of <code>lt_data_out</code>.</p> <p>If both <code>irdyn</code> and <code>trdyn</code> are asserted on the previous cycle, the master drives the next byte enable (Byte Enable 2) on <code>cben[3:0]</code>. If the PCI master is still ready to write data, it keeps <code>irdyn</code> asserted and drives the next DWORD (Data 2) on <code>ad[31:0]</code>.</p> <p>If both <code>irdyn</code> and <code>trdyn</code> were asserted on the previous cycle, the Core asserts <code>lt_ldata_xfern</code> to the back-end to signify that Data 1 is valid. With <code>lt_ldata_xfern</code> asserted, the back-end doesn't write the data or increment the address counter.</p> <p><u>Double Word Aligned</u></p> <p>The Core keeps <code>trdyn</code> asserted and puts Data 1 on the upper DWORD of <code>lt_data_out</code>.</p> <p>If both <code>irdyn</code> and <code>trdyn</code> are asserted on the previous cycle, the master drives the next byte enables (Byte Enable 2) on <code>cben[3:0]</code>. If the master is still ready to write data, it keeps <code>irdyn</code> asserted and drives the next DWORD (Data 2) on <code>ad[31:0]</code>.</p> <p>If <code>irdyn</code>, <code>trdyn</code> and <code>lt_rdyn</code> are asserted on the previous cycle, the Core asserts <code>lt_hdata_xfern</code> to the back-end to signify that Data 1 is valid. With <code>lt_hdata_xfern</code> asserted, the back-end can safely write the QWORD (Don't care and Data 1) and increment the address counter.</p>
7	Data 3	<p><u>Quad Word Aligned</u></p> <p>The back-end puts Data 2 on <code>lt_data_out</code>. If the back-end keeps <code>lt_rdyn</code> asserted on the previous cycle, the Core keeps <code>trdyn</code> asserted.</p> <p>If both <code>irdyn</code> and <code>trdyn</code> are asserted on the previous cycle, the master drives the next byte enables (Byte Enable 3) on <code>cben[3:0]</code>. If the master is still ready to write data, it keeps <code>irdyn</code> asserted and drives the next DWORD (Data 3) on <code>ad[31:0]</code>. The master signals the end of the burst when it de-asserts <code>framen</code>.</p> <p>The Core de-asserts <code>lt_ldata_xfern</code>. If <code>irdyn</code>, <code>trdyn</code> and <code>lt_rdyn</code> are asserted on the previous cycle, the Core asserts <code>lt_hdata_xfern</code> to the back-end to signify that Data 2 is valid. With <code>lt_hdata_xfern</code> asserted, the back-end can safely write the QWORD (Data 1 and Data 2) and increment the address counter.</p> <p><u>Double Word Aligned</u></p> <p>The Core keeps <code>trdyn</code> asserted and puts Data 2 on <code>lt_data_out</code>.</p> <p>If both <code>irdyn</code> and <code>trdyn</code> are asserted on the previous cycle, the master drives the next byte enables (Byte Enable 3) on <code>cben[3:0]</code>. If the master is still ready to write data, it keeps <code>irdyn</code> asserted and drives the next DWORD (Data 3) on <code>ad</code>. The master signals the end of the burst when it de-asserts <code>framen</code>.</p> <p>The Core de-asserts <code>lt_hdata_xfern</code>. If both <code>irdyn</code> and <code>trdyn</code> are asserted on the previous cycle, the Core asserts <code>lt_ldata_xfern</code> to the back-end to signify Data 2 is valid. With <code>lt_ldata_xfern</code> asserted, the back-end doesn't write the data or increment the address counter.</p>

Table 2-44. 32-bit Target Burst Write Transaction With a 64-bit Local Interface (Continued)

CLK	PCI Data Phase	Description
8	Turn around	<p><u>Quad Word Aligned</u></p> <p>The Core puts Data 3 on <code>lt_data_out</code>.</p> <p>If both <code>irdyn</code> and <code>trdyn</code> are asserted on the previous cycle, the master relinquishes control of <code>framen</code>, <code>ad</code> and <code>cbe</code>. It also de-asserts <code>irdyn</code> if both <code>trdyn</code> and <code>irdyn</code> were asserted last cycle.</p> <p>The Core de-asserts <code>lt_hdata_xfern</code>. If both <code>irdyn</code> and <code>trdyn</code> are asserted on the previous cycle, the Core asserts <code>lt_ldata_xfern</code> to the back-end to signify Data 3 was transferred successfully. With <code>lt_ldata_xfern</code> asserted, the back-end doesn't write the data yet nor increment the address counter. It de-asserts both <code>devseln</code> and <code>trdyn</code> if both <code>trdyn</code> and <code>irdyn</code> were asserted last cycle.</p>
9	Cleanup	The Core de-asserts <code>lt_ldata_xfern</code> . If <code>lt_rdyn</code> is asserted on the previous cycle, the Core asserts <code>lt_hdata_xfern</code> to signify to the back-end that it can safely write the QWORD (Data 3 and Don't care).
10	Idle	The Core signals to the back-end that the transaction is complete by clearing <code>bar_hit</code> . It also de-asserts <code>lt_hdata_xfern</code> . The target relinquishes control of <code>devseln</code> and <code>trdyn</code> .

Dual Address Cycle (DAC)

The PCI master uses a Dual Address Cycle (DAC) to inform the PCI IP core, operating as a target, that it is using 64-bit addressing with two back-to-back address phases. The PCI IP core can respond to 64-bit addressing when the memory address being accessed is over the 4GB limit. 64-bit addressing is not restricted to only 64-bit configurations of the PCI IP core.

[Figure 2-40](#) shows an example of the DAC during a 32-bit read transaction. [Table 2-45](#) gives a clock-by-clock description of the dual address cycle.

Figure 2-40. 32-Bit Target Dual Address Cycle

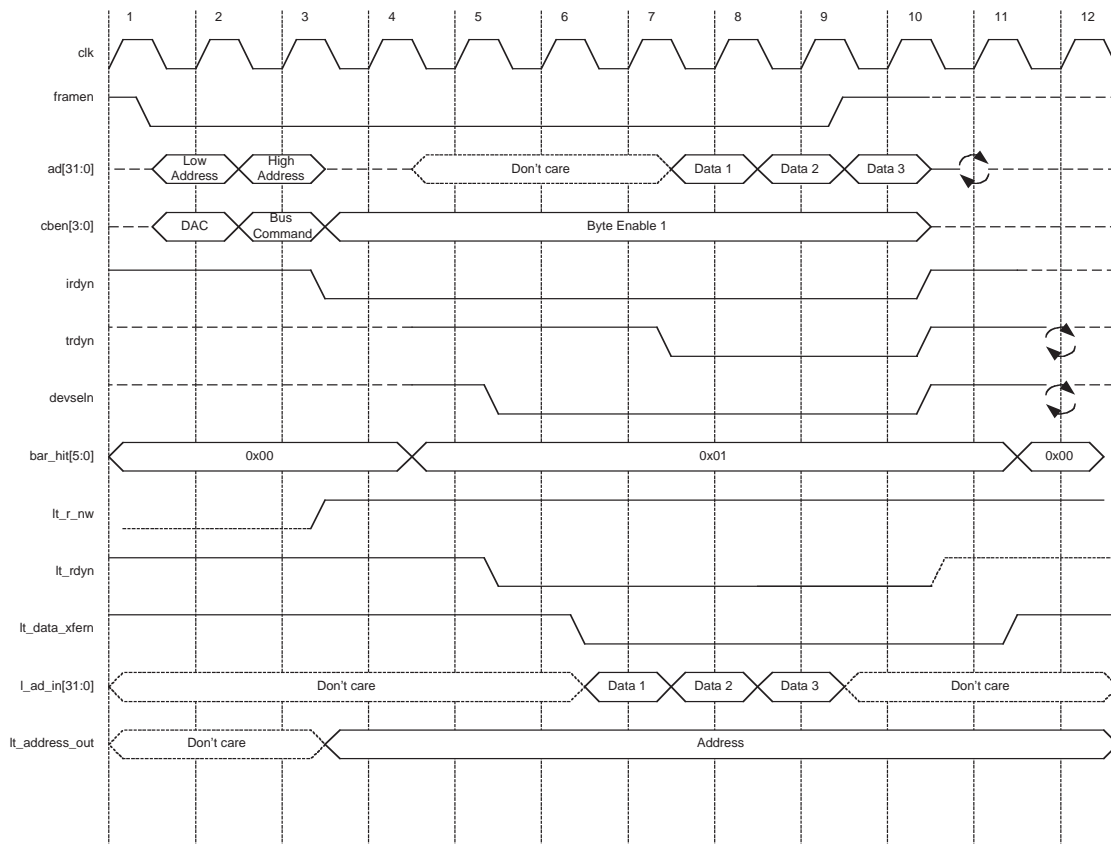

Table 2-45. 32-Bit Target Dual Address Cycle

CLK	PCI Data Phase	Description
1	Address	The master asserts <code>framen</code> and drives <code>ad[31:0]</code> (lower address and <code>cben[3:0]</code> (DAC).
2	Address	The master drives the <code>ad[31:0]</code> (higher address) and <code>cben[3:0]</code> (Bus command).
3	Turn around	The master tri-states <code>ad[31:0]</code> and drives the first byte enables (Byte Enable 1) on <code>cben[3:0]</code> . If the master is ready to receive data, it asserts <code>irdyn</code> . The Core starts to decode the address and command. The Core drives the <code>lt_address_out</code> to the back-end application.
4	Wait	If there is an address match, the Core drives the <code>bar_hit</code> signals to the back-end. The back-end can use <code>bar_hit</code> as a chip select.
5	Wait	If the <code>DEVSEL_TIMING</code> is set to slow, the Core asserts <code>devseln</code> on the clock after <code>bar_hit</code> . If the back-end will be ready to put data out on the next cycle, it asserts <code>lt_rdyn</code> .
6	Wait	The Core asserts <code>lt_data_xfern</code> since <code>lt_rdyn</code> was asserted on the previous cycle. The back-end drives the first DWORD (Data 1) on <code>l_ad_in</code> .
7	Data 1	With <code>lt_rdyn</code> asserted previous two cycles, the PCI IP core asserts <code>trdyn</code> and puts Data 1 on <code>ad[31:0]</code> . The Core asserts <code>lt_data_xfern</code> since <code>lt_rdyn</code> was asserted on the previous cycle. The back-end drives the second DWORD (Data 2) on <code>l_ad_in</code> .
8	Data 2	With <code>lt_rdyn</code> asserted previous two cycles, the PCI IP core asserts <code>trdyn</code> and puts Data 1 on <code>ad[31:0]</code> . The Core asserts <code>lt_data_xfern</code> since <code>lt_rdyn</code> was asserted on the previous cycle. The back-end drives the second DWORD (Data 3) on <code>l_ad_in</code> .
9	Data3	The master asserts <code>irdyn</code> and de-asserts <code>framen</code> . With <code>lt_rdyn</code> asserted previous two cycles, the PCI IP core asserts <code>trdyn</code> and puts Data 3 on <code>ad[31:0]</code> .
10	Turn around	The master relinquishes control of <code>framen</code> and <code>cben[3:0]</code> . It de-asserts <code>irdyn</code> if both <code>trdyn</code> and <code>irdyn</code> were asserted last cycle. The Core relinquishes control of <code>ad</code> . It de-asserts both <code>devseln</code> and <code>trdyn</code> if both <code>trdyn</code> and <code>irdyn</code> were asserted last cycle. The Core also signals to the back-end that the transaction is complete by clearing <code>bar_hit</code> . The Core de-asserts <code>lt_data_xfern</code> .
11	Idle	The Core relinquishes <code>devseln</code> and <code>trdyn</code> .

Fast Back-to-Back Transactions

The PCI IP core, as a target, can respond to a fast back-to-back transaction if a PCI master wants to perform two or more consecutive transactions to the PCI IP core. The fast back-to-back transaction consists of two or more complete PCI transactions without an idle state between them. [Figure 2-41](#) and [Table 2-46](#) illustrate a fast back-to-back write transaction. The figure illustrates how the PCI interface correlates to the Local Interface. The table explains each event in the figure with a clock-by-clock description.

Figure 2-41. 32-bit Target Fast Back-to-Back Transaction



Table 2-46. 32-bit Target Fast Back-to-Back Transaction

CLK	PCI Data Phase	Description
1	Address	The PCI master asserts <i>framen</i> and drives <i>ad[31:0]</i> and <i>cben[3:0]</i> .
2	Wait	The PCI master drives the first byte enables (Byte Enable 1) on <i>cben[3:0]</i> . If the master is ready to write data, it asserts <i>irdyn</i> and drives the first DWORD (Data 1) on <i>ad[31:0]</i> . The Core starts to decode the address and command. The target drives the <i>lt_address_out</i> to the back-end application.
3	Wait	If there is an address match, the Core drives the <i>bar_hit</i> signals to the back-end. The back-end application can use <i>bar_hit</i> as a chip select.
4	Wait	If the <i>DEVSEL_TIMING</i> is set to slow, the Core asserts <i>devseln</i> on the clock after <i>bar_hit</i> . If the back-end will be ready in two cycles to write data, it can assert <i>lt_rdyn</i> .
5	Data 1	<i>trdyn</i> is asserted since <i>lt_rdyn</i> was asserted the previous cycle.
6	Address	The master asserts <i>framen</i> and drives the <i>ad[31:0]</i> and <i>cben[3:0]</i> . If both <i>irdyn</i> and <i>lt_rdyn</i> are asserted on the previous cycle, the Core asserts <i>lt_data_xfern</i> to the back-end to signify Data 1 is valid. With <i>lt_data_xfern</i> asserted the back-end can safely write Data 1.
7	Wait	The PCI master drives the first byte enables (Byte Enable 1) on <i>cben[3:0]</i> . If the master is ready to write data, it asserts <i>irdyn</i> and drives the first DWORD (Data 1) on <i>ad[31:0]</i> . The Core starts to decode the address and command. The Core drives the <i>lt_address_out</i> to the back-end.
8	Wait	If there is an address match, the Core drives the <i>bar_hit</i> signals to the back-end. The back-end can use <i>bar_hit</i> as a chip select.

Table 2-46. 32-bit Target Fast Back-to-Back Transaction (Continued)

CLK	PCI Data Phase	Description
9	Wait	If the DEVSEL_TIMING is set to slow, the Core asserts devseln on the clock after bar_hit. If the back-end will be ready to write data in two cycles, it can assert lt_rdyn.
10	Data 1	trdyn is asserted since lt_rdyn was asserted the previous cycle.
12	Termination	If both irdyn and trdyn are asserted on the previous cycle, the master relinquishes control of framen, ad[31:0] and cben[3:0]. It also de-asserts irdyn if both trdyn and irdyn were asserted last cycle.
13	Idle	The Core relinquishes devseln and trdyn.

Advanced Configuration Accesses

Advanced Configuration Space read accesses are very similar to the 32-bit target read transactions with additional PCI and Local bus signals. [Figure 2-42](#) and [Table 2-47](#) illustrate advanced Configuration Space read transactions.

Figure 2-42. Advanced Configuration Read Transaction



Table 2-47. Advanced Configuration Read Transactions

CLK	PCI Data Phase	Description
1	Address	The master asserts <code>framen</code> and <code>idsel</code> . It and drives the configuration address on <code>ad[31:0]</code> and the read command on <code>cben[3:0]</code> .
2	Turn around	The master tri-states the <code>ad[31:0]</code> lines and drives the first byte enables <code>cben[3:0]</code> . If the master is ready to receive data, it asserts <code>irdyn</code> . The Core starts to decode the address and command. The target drives the <code>lt_address_out</code> to the back-end.
3	Wait	If there is an address match, the Core drives the <code>new_cap_hit</code> signals to the back-end. The back-end can use the <code>new_cap_hit</code> as a chip select.
4	Wait	If the device select timing is set to slow, the Core asserts <code>devseln</code> on the clock after <code>new_cap_hit</code> . If the back-end is ready to put data out on the next cycle, it can assert <code>lt_rdyn</code> .
5	Wait	The Core asserts <code>lt_data_xfern</code> since <code>lt_rdyn</code> was asserted the previous cycle. The back-end drives the first DWORD (Data 1) on <code>l_ad_in</code> .
6	Data 1	With <code>lt_rdyn</code> asserted for the previous two cycles, the Core asserts <code>trdyn</code> and puts Data 1 on <code>ad[31:0]</code> .
7	Turn around	The master relinquishes control of <code>framen</code> and <code>cben[3:0]</code> . It de-asserts <code>irdyn</code> if both <code>trdyn</code> and <code>irdyn</code> were asserted on the last cycle. The Core relinquishes control of <code>ad[31:0]</code> . It de-asserts both <code>devseln</code> and <code>trdyn</code> if both <code>trdyn</code> and <code>irdyn</code> were asserted on the last cycle. The Core also signals to the back-end that the transaction is complete by clearing <code>new_cap_hit</code> . The Core de-asserts <code>lt_data_xfern</code> .
8	Idle	The Core relinquishes <code>devseln</code> and <code>trdyn</code> .

Advanced Configuration Space write accesses are similar to the 32-bit target write transactions with additional PCI and Local bus signals. [Figure 2-43](#) and [Table 2-48](#) illustrate advanced Configuration Space write transactions.

Figure 2-43. Advanced Configuration Write Transaction



Table 2-48. Advanced Configuration Write Transaction

CLK	PCI Data Phase	Description
1	Address	The master asserts <code>framen</code> and <code>idsel</code> . It and drives the configuration address on <code>ad[31:0]</code> and the read command on <code>cben[3:0]</code> .
2	Wait	The PCI master drives the first byte enables (Byte Enable 1) on <code>cben[3:0]</code> . If it is ready to write data, it asserts <code>irdyn</code> and drives the first DWORD (Data 1) on <code>ad[31:0]</code> . The Core starts to decode the address and command.
3	Wait	If there is an address match, the Core drives the <code>new_cap_hit</code> signals to the back-end. The back-end can use <code>new_cap_hit</code> as a chip select.
4	Wait	If the <code>DEVSEL_TIMING</code> is set to slow, the Core asserts <code>devseln</code> on the clock after <code>new_cap_hit</code> . If the back-end is ready to write data in two cycles, it can assert <code>lt_rdyn</code> .
5	Data 1	<code>trdyn</code> is asserted since <code>lt_rdyn</code> was asserted the previous cycle.
6	Turn around	If both <code>irdyn</code> and <code>trdyn</code> are asserted on the previous cycle, the master relinquishes control of <code>framen</code> , <code>ad[31:0]</code> and <code>cben[3:0]</code> . It also de-asserts <code>irdyn</code> if both <code>trdyn</code> and <code>irdyn</code> were asserted last cycle. It de-asserts both <code>devseln</code> and <code>trdyn</code> if both <code>trdyn</code> and <code>irdyn</code> were asserted last cycle.
7	Idle	The Core signals to the back-end that the transaction is complete by clearing <code>new_cap_hit</code> . It also de-asserts <code>lt_data_xfern</code> . The Core relinquishes <code>devseln</code> and <code>trdyn</code> .

Target Termination

The back-end application has full control over the termination of all PCI transactions requesting information from the Local Interface. The back-end application must handle the termination properly. The four types of target-initiated termination are:

- Retry
- Target Abort
- Disconnect With Data
- Disconnect Without Data

The back-end application utilizes the Local Interface signals `lt_abortn`, `lt_disconnectn`, and `lt_rdyn` to initiate termination. These signals control the target's response and termination of PCI transactions that request data from the Local Interface. [Table 2-49](#) shows a summary of the different target initiated termination types.

In order to prevent a PCI IP core from monopolizing the PCI bus, the *PCI Local Bus Specification, Revision 3.0* includes limitations on the amount of transferring time for a target. During the initial data phase, the target must issue a Retry if it cannot respond within 16 clocks of `framen` being asserted. For subsequent data phases following the initial data phase, the PCI IP core must respond within eight clock cycles or issue a Disconnect Without Data or a Target Abort. The first option is preferred. The different target initiated termination sequences are discussed in the following section.

Table 2-49. Target Initiated Termination Summary

Termination Type	lt_rdyn	lt_disconnectn	lt_abortn	Comments
Disconnect With Data	Asserted	Asserted	De-asserted	Some data is transferred. This includes the current DWORD or QWORD. If the PCI master needs to transfer more data, the transaction is re-initiated using the next address.
Disconnect Without Data	De-asserted	Asserted	De-asserted	Some data is transferred but not the current DWORD or QWORD. This occurs in a data phase other than the first phase. The master may resume the transaction or not. If resumed, it starts on the same address.
Retry	De-asserted	Asserted	De-asserted	No data is transferred. This occurs during the first data phase. Master may or may not try the same transaction.
Target Abort	Don't Care	Don't Care	Asserted	Indicates a fatal error. Data is disregarded.

Disconnect With Data

A Disconnect With Data occurs after at least one DWORD or QWORD has been transferred. The difference between a Disconnect With Data and a Disconnect Without Data depends on the state of `lt_rdyn` when the Local Interface requests a disconnect using the `lt_disconnectn` signal. This condition indicates if the bus transaction is terminated before or after the completion of the current data phase. Once the current data phase is completed, the bus transaction is terminated with a Disconnect With Data. [Figure 2-44](#) and [Table 2-50](#) show a Disconnect With Data on a read transaction.

Below is a list of the reasons for the PCI IP core to perform a Disconnect With Data:

- Target is slow to complete subsequent data phase
- Target does not support requested burst mode
- Memory target does not understand addressing sequence
- Transfer crosses over target's address boundary

Figure 2-44. 32-bit Target Disconnect with Data for Read Transaction

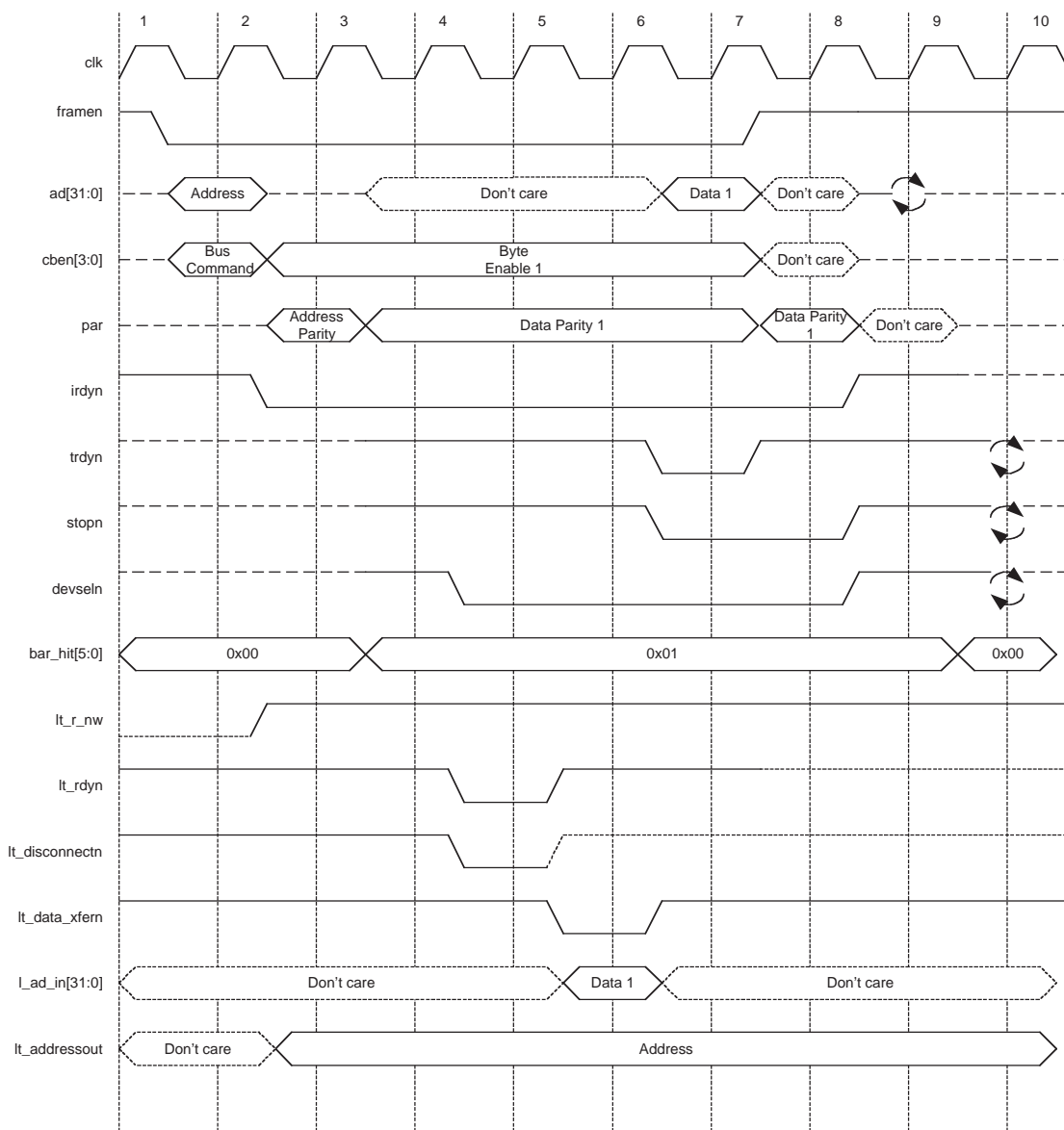

Table 2-50. 32-bit Target Disconnect with Data for Read Transaction

CLK	Description
4	The <code>devseln</code> signal is driven low to indicate that the PCI IP core is selected for the transaction. The <code>lt_rdyn</code> signal is driven low to indicate that the back-end application is ready to provide data on the next clock cycle. Because the target cannot complete any more PCI data phases, the <code>lt_disconnectn</code> signal is also driven low.
5	The <code>lt_data_xferm</code> signal is driven low by the PCI IP core to the back-end to indicate that data is available on <code>l_ad_in</code> .
6	The <code>trdyn</code> and <code>stopn</code> signals are driven low because both <code>lt_rdyn</code> and <code>lt_disconnectn</code> were driven low during the previous two clock cycles. The <code>lt_data_xferm</code> signal is de-asserted because <code>lt_rdyn</code> was de-asserted during the previous cycle. Data 1 is presented on the PCI bus via <code>ad[31:0]</code> .
7	The PCI master de-asserts <code>framen</code> to acknowledge the disconnection initiated by the target. The PCI IP core de-asserts <code>trdyn</code> since the completion of the last PCI data phase and the assertion of <code>stopn</code> .

Table 2-50. 32-bit Target Disconnect with Data for Read Transaction (Continued)

CLK	Description
8	De-asserting <i>irdyn</i> disconnects the PCI master. De-asserting <i>devseln</i> and <i>stopn</i> . Disconnects the PCI IP core from the PCI bus.
9	The larger relinquishes <i>devseln</i> , <i>stopn</i> and <i>trdyn</i> .

Figure 2-45 and Table 2-51 illustrate a Disconnect With Data on a write transaction.

Figure 2-45. 32-bit Target Disconnect with Data for Write Transaction

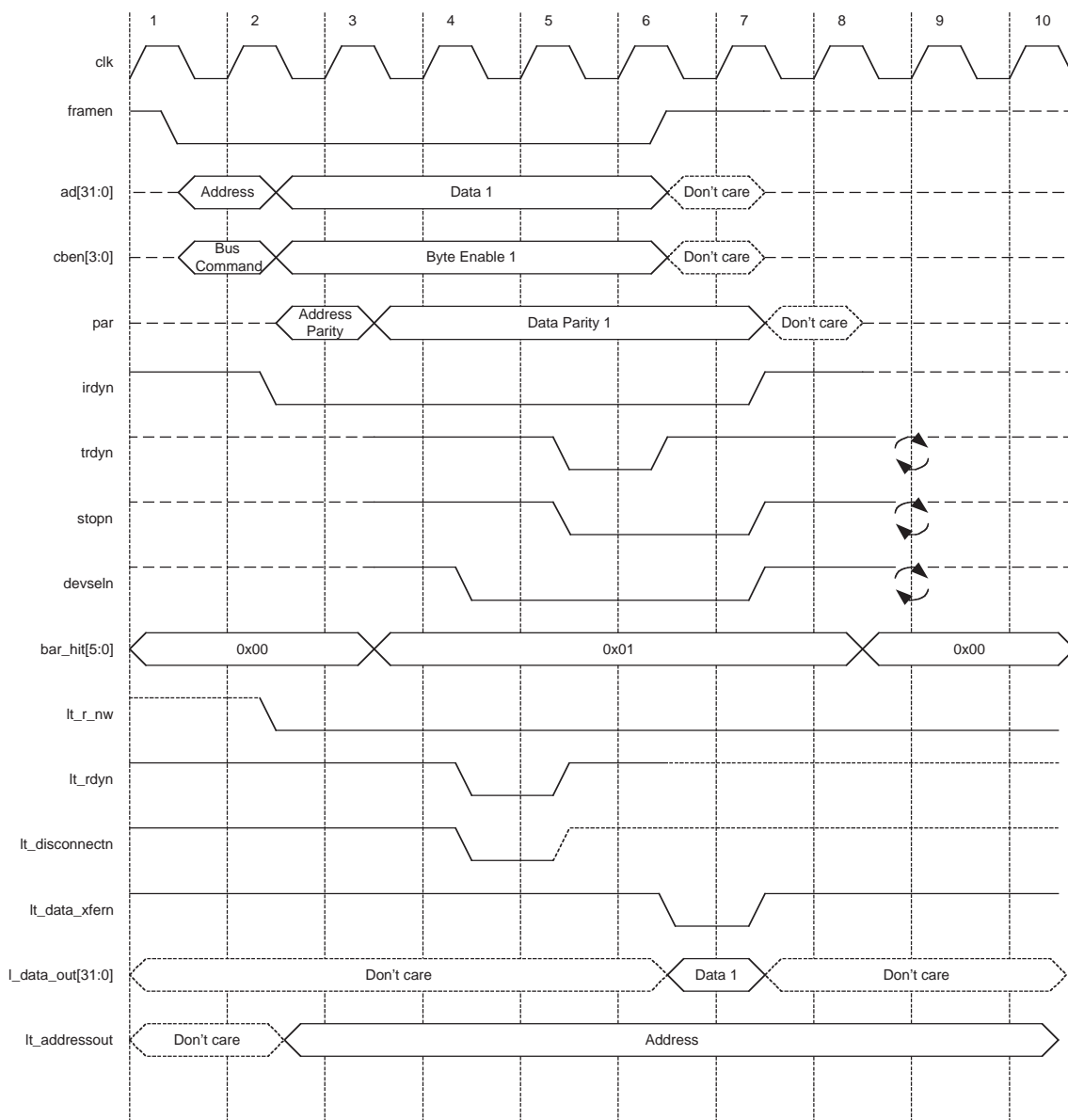

Table 2-51. 32-bit Target Disconnect with Data for Write Transaction

CLK	Description
4	The <code>devseln</code> signal is driven low to indicate that the PCI IP core has been selected for the transaction. The <code>lt_rdyn</code> signal is driven low to indicate that the back-end application is ready to receive data. Because the target can not complete any more PCI data phases the <code>lt_disconnectn</code> signal is also driven low.
5	The <code>trdyn</code> and the <code>stopn</code> signals are driven low because both the <code>lt_rdyn</code> and the <code>lt_disconnectn</code> signals were driven low the previous cycle.
6	The target asserts <code>lt_data_xfern</code> to the back-end to signify Data 1 is available on the <code>lt_data_out</code> . The PCI IP core de-asserts <code>trdyn</code> since the last PCI data phase was complete and the <code>stopn</code> was asserted. The PCI master de-asserts the <code>framen</code> to acknowledge the disconnection initiated by the target.
7	The PCI master disconnects by de-asserting <code>irdyn</code> . The PCI IP core disconnects from the PCI bus by de-asserting <code>devseln</code> and <code>stopn</code> .
8	The target relinquishes <code>devseln</code> , <code>stopn</code> and <code>trdyn</code> .

Disconnect Without Data

A Disconnect Without Data occurs after at least one data DWORD or QWORD has been transferred. A Disconnect Without Data is used if the PCI IP core is incapable of completing the current PCI data phase. [Figure 2-46](#) and [Table 2-52](#) show a Disconnect Without Data for a read transaction.

Below is a list of the reasons that the PCI IP core may Disconnect Without Data:

- Target slow to complete subsequent data phase
- Target does not support burst mode requested
- Memory target doesn't understand addressing sequence
- Transfer crosses over target's address boundary

Figure 2-46. 32-bit Target Disconnect Without Data for Read Transaction

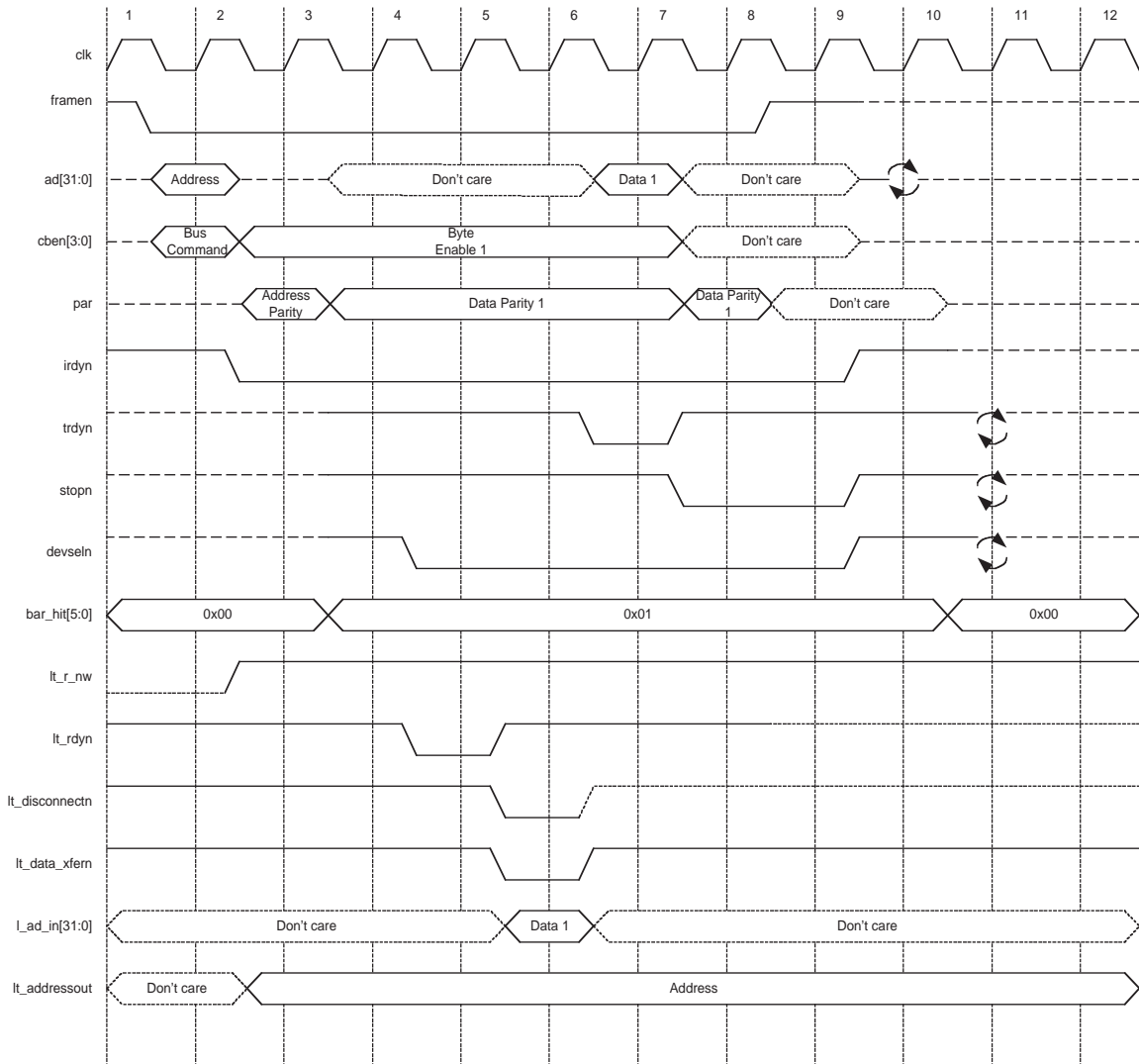

Table 2-52. 32-bit Target Disconnect Without Data for Read Transaction

CLK	Description
4	The devseln signal is driven low to indicate that the PCI IP core is selected for the transaction. The lt_r_dyn signal is driven low to indicate that the back-end application is ready to provide data on the next clock cycle.
5	The lt_data_xfern signal is driven low by the PCI IP core to indicate that data is valid on l_ad_in[31:0] . Because the target can not complete any more PCI data phases the lt_r_dyn signal is driven high and lt_disconnectn signals are driven low.
6	The trdyn signal is driven low because the lt_r_dyn signal was driven low two clock cycle before. The lt_data_xfern signal is de-asserted because the lt_r_dyn signal was de-asserted in the previous cycle. Data 1 is presented to the PCI bus via ad[31:0] .
7	The trdyn signal is de-asserted since the lt_r_dyn signal was driven high two clock cycles before. The stopn signal is asserted since the lt_disconnectn signal was driven low two clock cycles before.
8	The PCI master de-asserts the framen to acknowledge the disconnection initiated by the target.
9	The PCI master disconnects by de-asserting the irdyn . The PCI IP core disconnects from the PCI bus by de-asserting the devseln and stopn .

Figure 2-47 and Table 2-53 illustrate a Disconnect Without Data for a write transaction.

Figure 2-47. 32-bit Target Disconnect Without Data for Write Transaction



Table 2-53. 32-bit Target Disconnect Without Data for Write Transaction

CLK	Description
4	The devseln signal is driven low to indicate that the PCI IP core is selected for the transaction. The lt_rdyn signal is driven low to indicate that the back-end application is ready to receive data.
5	The trdyn signal is driven low because the lt_rdyn signal was driven low on the previous clock cycle. Data 1 is presented to the PCI bus via ad[31:0]. Because the target can not complete any more PCI data phases the lt_rdyn signal is driven high and lt_disconnectn signals are driven low.
6	The target asserts lt_data_xfern to the back-end to signify Data 1 is available on the lt_data_out. The trdyn signal is de-asserted since the lt_rdyn signal was driven high the previous cycle. And the stopn signal is asserted since the lt_disconnectn signal was driven low the previous cycle.
7	The PCI master de-asserts the framen to acknowledge the disconnection initiated by the target.
8	The PCI IP core disconnects from the PCI bus by de-asserting the devseln and stopn.
9	Idle

Retry

A Retry may be necessary if the PCI IP core cannot assert the `trdyn` signal within the maximum number of clock cycles defined by the *PCI Local Bus Specification, Revision 3.0*. A Retry occurs if `lt_rdyn` is not asserted before `lt_disconnectn` is asserted. A Retry can also occur if the PCI IP core does not assert `lt_rdyn` within 16 clocks after the assertion of `framen`. [Figure 2-48](#) and [Table 2-54](#) show a Retry on a read transaction.

Below is a list of the reasons for a Retry.

- Target is very slow to respond to complete first data phase
- Snoop hit occurs on modified cache line
- Resource is busy

Figure 2-48. 32-bit Target Retry for Read Transaction



Table 2-54. 32-bit Target Retry for Read Transaction

CLK	Description
4	The <code>devseln</code> signal is driven low to indicate that the PCI IP core is selected for the transaction. The <code>lt_rdyn</code> signal remains high to indicate that the back-end application is not ready to provide data. Because the target can not complete any PCI data phases, the <code>lt_rdyn</code> signal remains high and the <code>lt_disconnectn</code> signal is driven low.
5	The <code>lt_data_xfern</code> signal remains high because the <code>lt_rdyn</code> signal was high during the previous cycle.
6	The <code>stopn</code> signal is driven low on the PCI bus as the <code>lt_disconnectn</code> signal was driven low for the previous two clock cycles.
7	The PCI master de-asserts the <code>framen</code> to acknowledge the retry initiated by the target.
8	The PCI master terminates the transaction by de-asserting the <code>irdyn</code> . The PCI IP core de-asserts the <code>devseln</code> and <code>stopn</code> .
9	Idle

Figure 2-49 and Table 2-55 show a Retry on a write transaction.

Figure 2-49. 32-bit Target Retry for Write Transaction



Table 2-55. 32-bit Target Retry for Write Transaction

CLK	Description
4	The <code>devseln</code> signal is driven low to indicate that the PCI IP core is selected for the transaction. The <code>lt_rdyn</code> signal remains high to indicate that the back-end application is not ready to provide data. Because the target can not complete any PCI data phases, the <code>lt_rdyn</code> signal remains high and the <code>lt_disconnectn</code> signal is driven low.
5	The <code>lt_data_xfern</code> signal remains high because the <code>lt_rdyn</code> signal was high during the previous cycle.
6	The <code>stopn</code> signal is driven low on the PCI bus as the <code>lt_disconnectn</code> signal was driven low for the previous two clock cycles.
7	The PCI master de-asserts the <code>framen</code> to acknowledge the retry initiated by the target.

Table 2-55. 32-bit Target Retry for Write Transaction (Continued)

CLK	Description
8	The PCI master terminates the transaction by de-asserting the <code>irdyn</code> . The PCI IP core de-asserts the <code>devseln</code> and <code>stopn</code> .
9	Idle

Target Abort

Unlike the other types of disconnects, the state of `irdyn` does not have any effect on termination during a Target Abort. [Figure 2-50](#) illustrates a Target Abort during a read transaction.

Some possible reasons for a target abort are:

- Broken target
- I/O addressing error
- Address phase parity error

[Figure 2-50](#) and [Table 2-56](#) show a target abort on a read transaction.

Figure 2-50. 32-bit Target Abort for Read Transaction



Table 2-56. 32-bit Target Abort for Read Transaction

CLK	Description
4	The <code>devseln</code> signal is driven low to indicate that the PCI IP core is selected for the transaction. The <code>lt_rdyn</code> signal is driven low to indicate that the back-end application is ready to put data out on the next cycle.
5	The <code>lt_data_xfern</code> signal is driven low by the PCI IP core to the back-end to indicate that data on <code>l_ad_in</code> is being read. The <code>lt_rdyn</code> signal is driven low to indicate the back-end is ready to provide the next data.
6	The <code>trdyn</code> signal is driven low because the <code>lt_rdyn</code> signal was driven low two clock cycles before. The <code>lt_data_xfern</code> signal is asserted because the <code>lt_rdyn</code> signal was asserted in the previous cycle. Data 1 is presented to the PCI bus via <code>ad[31:0]</code> . Because the back-end wants to abort the transaction the <code>lt_abortn</code> signal is driven low. The data on <code>l_ad_in</code> is also invalid.
7	A target abort is requested as the <code>devseln</code> and the <code>trdyn</code> signals are de-asserted and the <code>stopn</code> signal is asserted.
8	The PCI master de-asserts the <code>framen</code> to acknowledge the target abort.
9	The PCI master terminates the transaction by de-asserting the <code>irdyn</code> . The PCI IP core de-asserts the <code>stopn</code> .

Figure 2-51 and Table 2-57 show a target abort on a write transaction.

Figure 2-51. 32-bit Target Abort for Write Transaction



Table 2-57. 32-bit Target Abort for Write Transaction

CLK	Description
4	The <code>devseln</code> signal is driven low to indicate that the PCI IP core is selected for the transaction. The <code>lt_rdyn</code> signal is driven low to indicate that the back-end application is ready to receive data on the next two cycles.
5	The target asserts <code>trdyn</code> because <code>lt_rdyn</code> was asserted on previous cycle. The first data phase is completed.
6	The <code>trdyn</code> signal remains low because the <code>lt_rdyn</code> signal was driven low two clock cycles before. The <code>lt_data_xfern</code> signal is asserted because the <code>lt_rdyn</code> signal was de-asserted in the previous cycle. The target transfers data 1 on <code>lt_data_out[31:0]</code> . Because the back-end wants to abort the transaction the <code>lt_abortn</code> signal is driven low.
7	A target abort is requested as the <code>devseln</code> and the <code>trdyn</code> signals are de-asserted and the <code>stopn</code> signal is asserted.
8	The PCI master de-asserts the <code>framen</code> to acknowledge the target abort.
9	The PCI master terminates the transaction by de-asserting the <code>irdyn</code> . The PCI IP core de-asserts the <code>stopn</code> .

Parameter Settings

The IPexpress tool is used to create IP and architectural modules in the Diamond and ispLEVER software. Refer to [“IP Core Generation” on page 143](#) for a description on how to generate the IP.

Table 3-1 provides the list of user configurable parameters for the PCI IP core. The parameter settings are specified using the PCI IP core Configuration GUI in IPexpress. The numerous PCI Express parameter options are partitioned across multiple GUI tabs as shown in this chapter.

Table 3-1. Parameter Descriptions

Parameter	Range	Default
Bus		
PCI Data Bus Size	32, 64	32
Local Master Data Bus Size ¹	32, 64	32
Local Target Data Bus Size ¹	32, 64	32
Local Data Bus Size ²	32, 64	32
Local Address Bus Width	32, 64	32
Bus Speed	33MHz, 66MHz	—
Identification		
Vendor ID [15:0]	0x 0000-FFFF	0x 1573
Device ID [15:0]	0x 0000-FFFF	0x 0000
Subsystem Vendor ID [15:0]	0x 0000-FFFF	0x 0000
Subsystem ID [15:0]	0x 0000-FFFF	0x 0000
Revision ID [7:0]	0x 00-FF	0x 01
Class Code (Base Class, Sub Class Interface)	0x 00-FF 0x 00-FF 0x 00-FF	0x 05 0x 00 0x 00
Options		
Timing of DEVSEL	slow	slow
Expansion ROM	Yes, No	No
Address Space Size	None, 2k, 4k, 8k, ... , 16M	None
Capabilities Pointer [7:0]	{Yes, No} 0x 00-FF	Yes 0x 40
CardBus CIS Pointer [31:0]	0x 00000000 - 0x FFFFFFFF	0x 00000000
Fast Back to Back	Enable, Disable	Enable
Interrupt Acknowledge	Yes, No	Yes
Interrupt Pin	None, INTAN	INTAN
PCI Master¹		
Read Only Latency Timer ¹	Yes, No	No
MIN_GNT ¹	0x 00-FF	0x 00
MAX_LAT ¹	0x 00-FF	0x 00
BARs		
Number of BARs	0 - 6	3
BAR0	0x 00000000 - 0x FFFFFFFF	0x FFFFFFFF
BAR1	0x 00000000 - 0x FFFFFFFF	0x FFFFFFF0

Table 3-1. Parameter Descriptions (Continued)

Parameter	Range	Default
BAR2	0x 00000000 - 0x FFFFFFFF	0x FFFFFFF0
BAR3 - BAR5	0x 00000000 - 0x FFFFFFFF	0x 00000000
BAR0 to BAR5 Configuration Options		
BAR width	32, 64	32
BAR Type	Memory, I/O	I/O for BAR0, Memory for BAR1, BAR2
Address Space Size	None, 4 bytes, 8 bytes, ... , 8G	4 bytes for BAR0 16 bytes for BAR1, BAR2
Prefetching Enable	Yes, No	No

1. Only for PCI Master/Target Core.

2. Only for PCI Target Core.

Bus Tab

Figure 3-1 shows the contents of the Bus tab. This example shows the PCI Master/Target 33.

Figure 3-1. Bus Tab

The screenshot shows the 'Bus Tab' configuration window with the following sections and settings:

- Bus Definition:**
 - PCI Data Bus Size: 32 bit, 64 bit
 - Local Master Data Bus Size: 32 bit, 64 bit
 - Local Target Data Bus Size: 32 bit, 64 bit
 - Local Address Bus Width: 32 bit, 64 bit
- Bus Speed:**
 - Bus Speed: 33 MHz, 66 MHz
- Backend Configuration:**
 - Enable backend configuraton
- Synthesis/Simulation Tools Selection:**
 - Support Synplify
 - Support Precision
 - Support ModelSim
 - Support ALDEC

Bus Definition

PCI Data Bus Size

The address and data width on the PCI side.

Local Master Data Bus Size (Master/Target cores only)

The data width for Local Master read/write transactions, must be the same as the PCI Data Bus Size.

Local Target Data Bus Size (Master/Target cores only)

The data width for Local Target read/write transactions, must be the same as the PCI Data Bus Size.

Local Data Bus Size (Target cores only)

The data width for Local side Target read/write transactions, must be the same as the PCI Data Bus Size.

Local Address Bus Width

The address width for Local Master and Target read/write transactions, must be the same as the PCI Data Bus Size.

Bus Speed

PCI bus operation frequency. A clock frequency on the PCI side. A fixed value that depends on the PCI core being used.

Backend Configuration**Enable Backend Configuration**

When this option is selected, the core works independently by configuring in the backend. The PCI core will provide a backend interface named `self_cfg`. The `self_cfg` interface can directly configure the PCI core after power on instead of another PCI master on PCI bus. The `self_cfg` interface can read/write the PCI core configuration space., The core takes the read/write command same as PCI config command(`cben=h02/h03`).

The `self_cfg` interface signals are listed in [Table 3-2](#).

Table 3-2. self_cfg Interface Signals

Port Name	Type	Corresponding PCI signals	Description
<code>self_cfg_en</code>	In		Self configuration enable signals, when it's 1'b1, pci bus will be blocked and replaced by <code>self_cfg</code> interface.
<code>self_cfg_addr</code>	In	<code>ad</code> (address cycle)	Address of configuration space
<code>self_cfg_data_in</code>	In	<code>ad</code> (data cycle of config write command)	Data write to configuration space
<code>self_cfg_data_out</code>	Out	<code>ad</code> (data cycle of config read command)	Data read from configuration space
<code>self_cfg_rd_wrn</code>	In	<code>cben(0)</code>	Specify the Read/write command. '1' define a read command, '0' define a write command.
<code>self_cfg_rdy</code>	Out	<code>!delsein & !trdyn</code>	Only valid for read command, '1' indicate that <code>self_cfg_data_out</code> is valid.

The backend asserts `self_cfg_en` to '1' and then starts configuring the PCI core. After configuration is finished, `self_cfg_en` is deasserted to '0'.

Synthesis/Simulation Tools Selection**Support Synplify**

If selected, IPexpress generates evaluation scripts and other associated files required to synthesize the top-level design using the Synplify synthesis tool.

Support Precision

If selected, IPexpress generates evaluation script and other associated files required to synthesize the top-level design using the Precision synthesis tool.

Support ModelSim

If selected, IPexpress generates evaluation script and other associated files required to synthesize the top-level design using the Modelsim simulator.

Support ALDEC

If selected, IPexpress generates evaluation script and other associated files required to synthesize the top-level design using the ALDEC simulator.

Identification Tab

Figure 3-2 shows the contents of the Identification tab. This example shows the PCI Master/Target 33.

Figure 3-2. Identification Tab

Field	Value
Vendor ID [15:0]	0x 1573
Device ID [15:0]	0x 0000
Subsystem Vendor ID [15:0]	0x 0000
Subsystem ID [15:0]	0x 0000
Revision ID [7:0]	0x 01
Class Code	
Base Class:	Sub Class:
0x 05	0x 00
Interface:	
0x 00	

Vendor ID [15:0]

The Vendor ID is a 16-bit parameter used to identify the manufacturer of the product. The Vendor ID is assigned by the PCI SIG to ensure uniqueness.

Device ID [15:0]

The Device ID is a 16-bit parameter defined by the manufacturer to uniquely identify a particular product or model.

Subsystem Vendor ID [15:0]

The Subsystem Vendor ID is a 16-bit parameter used to further identify the manufacturer of the expansion board or subsystem.

Subsystem ID [15:0]

The Subsystem ID is a 16-bit parameter used to further identify the particular device. This field is defined by the manufacturer to uniquely identify products or models.

Revision ID [15:0]

The Revision ID is an 8-bit parameter used by the manufacturer and should be viewed as an extension of the Device ID to distinguish between different functional versions of a PCI product.

Class Code (Base Class, Bus Class, Interface)

The Class Code is broken into three byte-size fields. The base class code broadly classifies the type of function the device performs. The sub-class code identifies more specifically the function of the device. The interface byte identifies a specific register-level programming interface.

Options Tab

Figure 3-3 shows the contents of the Options tab. This example shows the PCI Master/Target 33.

Figure 3-3. Options Tab

The screenshot shows the 'Options' tab selected in a software interface. The settings are as follows:

- Devsel Timing:** Timing of Devsel: Slow
- Expansion ROM BAR:**
 - Expansion ROM: Address Space Size: None
 - Read Only: Read Only Address: 0x 00000000
- Capabilities Pointer[7:0]:** 0x 40
- CardBus CIS Pointer[31:0]:** 0x 00000000
- Fast Back-to-Back:** Enable Disable
- Interrupts:**
 - Interrupt Acknowledge
 - Interrupt Pin: None INTAN

Devsel Timing

Timing of Devsel

The slowest time for a device to assert the devseln signal for all accesses except the configuration accesses. The PCI Core supports only the slow decode setting.

Expansion ROM BAR

Expansion ROM

When selected, includes support for the Expansion ROM option.

Address Space Size

Specifies the Expansion ROM address space size.

Read Only and Read Only Address

When Read Only is selected, the Expansion ROM base address is specified by the Read Only Address parameter and can only be read by other PCI devices. When Read Only is not selected, the Expansion ROM base address can be specified by another PCI master device via the PCI bus.

Capabilities Pointer

The Capabilities Pointer indicates the starting location of the Capabilities List.

CardBus CIS Pointer

The CardBus CIS Pointer is 32-bit register at location 28h in the Configuration Space. For more information on setting this register, refer to the CardBus specification.

Fast Back-to-Back

This option determines if the master Core supports two or more complete PCI transactions without an idle state between them.

Interrupts

Interrupt Acknowledge

This option determines if the PCI core supports Interrupt Acknowledge.

Interrupt Pin

Indicates which Interrupt Pin will be used by the PCI Core.

PCI Master Tab (PCI Master/Target Cores Only)

Figure 3-4 shows the contents of the PCI Master tab. This example shows the PCI Master/Target 33.

Figure 3-4. PCI Master Tab

Option	Value
<input type="checkbox"/> Read Only Latency Timer	0x 00
MIN_GNT	0x 00
MAX_LAT	0x 00

Read Only Latency Timer

A mechanism for ensuring that a bus master does not extend the access latency of other masters beyond a specified value.

MIN_GNT

An 8-bit parameter used to specify the length of time in microseconds for the Master to control the PCI bus.

MAX_LAT

An 8-bit parameter used to specify how often the PCI Core possess the bus.

BARs Tab

Figure 3-5 shows the contents of the BARs tab. This example shows the PCI Master/Target 33.

Figure 3-5. BARs Tab

Register	Address	Action
Base Address Registers		
Number of BARs: 3		
BAR0	0x FFFFFFFD	Configure
BAR1	0x FFFFFFF0	Configure
BAR2	0x FFFFFFF0	Configure
BAR3	0x 00000000	Configure
BAR4	0x 00000000	Configure
BAR5	0x 00000000	Configure

Base Address Registers

Number of BARs

The number of Base Address Registers configured by the user.

BAR0 - BAR5

The Base Address value used to map memory or I/O address space.

BAR Configuration Options

Figure 3-6 shows the BAR Configuration dialog box, which is displayed when the Configure button is pressed in the BARs tab.

Figure 3-6. BAR Configuration Options



BAR Width

The width of the Base Address Register. When using 64-bit width, the current BAR and next BAR will combine as the 64-bit Base Address.

BAR Type

Used to map memory or I/O space.

Address Space Size

The parameter is the size of the address range mapped to memory or I/O space.

Prefetching Enable

This option determines if the memory mapped by this BAR support prefetching operation.

This chapter provides information on how to generate the PCI IP core using the Diamond or ispLEVER software IPexpress tool, and how to include the core in a top-level design.

Licensing the IP Core

An IP core- and device-specific license is required to enable full, unrestricted use of the PCI IP core in a complete, top-level design. Instructions on how to obtain licenses for Lattice IP cores are given at:

<http://www.latticesemi.com/products/intellectualproperty/aboutip/isplicvercoreonlinepurchas.cfm>

Users may download and generate the PCI IP core and fully evaluate the core through functional simulation and implementation (synthesis, map, place and route) without an IP license. The PCI IP core also supports Lattice's IP hardware evaluation capability, which makes it possible to create versions of the IP core that operate in hardware for a limited time (approximately four hours) without requiring an IP license. See "[Hardware Evaluation](#)" on [page 148](#) for further details. However, a license is required to enable timing simulation, to open the design in the Diamond or ispLEVER EPIC tool, and to generate bitstreams that do not include the hardware evaluation timeout limitation.

Getting Started

The PCI IP core is available for download from the Lattice IP Server using the IPexpress tool. The IP files are automatically installed using ispUPDATE technology in any customer-specified directory. After the IP core has been installed, the IP core will be available in the IPexpress GUI dialog box shown in [Figure 4-1](#).

The IPexpress tool GUI dialog box for the PCI IP core is shown in [Figure 4-1](#). To generate a specific IP core configuration the user specifies:

- **Project Path** – Path to the directory where the generated IP files will be located.
- **File Name** – "username" designation given to the generated IP core and corresponding folders and files.
- **(Diamond) Module Output** – Verilog or VHDL.
- **(ispLEVER) Design Entry Type** – Verilog HDL or VHDL.
- **Device Family** – Device family to which IP is to be targeted (e.g. LatticeSCM, Lattice ECP2M, LatticeECP3, etc.). Only families that support the particular IP core are listed.
- **Part Name** – Specific targeted part within the selected device family.

Figure 4-1. IPexpress Dialog Box (Diamond Version)



Note that if the IPexpress tool is called from within an existing project, Project Path, Module Output (Design Entry in ispLEVER), Device Family and Part Name default to the specified project parameters. Refer to the IPexpress tool online help for further information.

To create a custom configuration, the user clicks the **Customize** button in the IPexpress tool dialog box to display the PCI IP core Configuration GUI, as shown in [Figure 4-2](#). From this dialog box, the user can select the IP parameter options specific to their application. Refer to [“Parameter Settings” on page 136](#) for more information on the PCI IP core parameter settings.

Figure 4-2. Configuration GUI (Diamond Version)



IPexpress-Created Files and Top Level Directory Structure

When the user clicks the **Generate** button in the IP Configuration dialog box, the IP core and supporting files are generated in the specified “Project Path” directory. The directory structure of the generated files is shown in [Figure 4-3](#). This example shows the directory structure generated with the PCI Master/Target 33 for LatticeECP3 device.

Figure 4-3. PCI IP Core Directory Structure



[Table 4-1](#) provides a list of key files and directories created by the IPexpress tool and how they are used. The IPexpress tool creates several files that are used throughout the design cycle. The names of most of the created files are customized to the user’s module name specified in the IPexpress tool.

Table 4-1. File List

File	Description
<username>.lpc	This file contains the IPexpress tool options used to recreate or modify the core in the IPexpress tool.
<username>.ipx	The IPX file holds references to all of the elements of an IP or Module after it is generated from the IPexpress tool (Diamond version only). The file is used to bring in the appropriate files during the design implementation and analysis. It is also used to re-load parameter settings into the IP/Module generation GUI when an IP/Module is being re-generated.
<username>.ngo	This file provides the synthesized IP core.
<username>_bb.v.vhd	This file provides the synthesis black box for the user’s synthesis.
<username>_inst.v.vhd	This file provides an instance template for the PCI IP core.
<username>_beh.v.vhd	This file provides the front-end simulation library for the PCI IP core.

[Table 4-2](#) provides a list of key additional files providing IP core generation status information and command line generation capability are generated in the user’s project directory.

Table 4-2. Additional Files

File	Description
<username>_generate.tcl	This file is created when the GUI “Generate” button is pushed. This file may be run from command line.
<username>_generate.log	This is the synthesis and map log file.

Table 4-2. Additional Files (Continued)

<code><username>_gen.log</code>	This is the IPexpress IP generation log file
---------------------------------------	--

Instantiating the Core

The generated PCI IP core package includes black-box (`<username>_bb.v/vhd`) and instance (`<username>_inst.v/vhd`) templates (Verilog or VHDL) that can be used to instantiate the core in a top-level design. An example RTL top-level reference source file that can be used as an instantiation template for the IP core is provided in `<project_dir>\pci_master_target_eval\<>username>\src\rtl\top`. Users may also use this top-level reference as the starting template for the top-level for their complete design.

Running Functional Simulation

Simulation support for the PCI IP core is provided for Aldec Active-HDL (Verilog and VHDL) simulator and Mentor Graphics ModelSim (Verilog only) simulator.

The functional simulation includes a PCI bus stimulus module (`pci_stim_tb`) and a local module (`lt_stim_tb`), which is instantiated in a top level (`pci_testbench_top`). Module `pci_stim_tb` simulates a master PCI to configure PCI core and test the core's basic read/write command.

The generated IP core package includes behavior model (`<username>_beh.v`) for functional simulation in the “Project Path” root directory, which `<username>_beh.v` is instantiated in PCI top model (`<project_dir>\pci_master_target_eval\<>username>\src\rtl\top`).

The simulation script supporting ModelSim evaluation simulation is provided in `<project_dir>\pci_master_target_eval\<>username>\sim\modelsim`.

The simulation script supporting Aldec evaluation simulation is provided in `<project_dir>\pci_master_target_eval\<>username>\sim\aldec`.

The Test Application Design is instantiated in a test-bench provided in `<project_dir>\pci_master_target_eval\testbench`.

Both ModelSim and Aldec simulation is supported via test bench files provided in `<project_dir>\pci_master_target_eval\testbench`. Models required for simulation are provided in the corresponding `\models` folder.

Users may run the Aldec evaluation simulation by doing the following:

1. Open Active-HDL.
2. Under the Tools tab, select **Execute Macro**.
3. Browse to folder `<project_dir>\pci_master_target_eval\<>username>\sim\aldec` and execute one of the “do” scripts shown.

Users may run the ModelSim evaluation simulation by doing the following:

1. Open ModelSim.
2. Under the File tab, select **Change Directory** and choose the folder `<project_dir>\pci_master_target_eval\<>username>\sim\modelsim`.
3. Under the Tools tab, select **Execute Macro** and execute the ModelSim “do” script shown.

Note: When the simulation completes, displayed on the console are:

```
<< Simulation complete... >>
```

<< Number of errors: 0 >>

Synthesizing and Implementing the Core in a Top-Level Design

Synthesis support for the PCI IP core is provided for Mentor Graphics Precision or Synopsys Synplify. The PCI IP core itself is synthesized and is provided in NGO format when the core is generated in IPexpress. Users may synthesize the core in their own top-level design by instantiating the core in their top-level as described previously and then synthesizing the entire design with either Synplify or Precision RTL synthesis.

The top-level file `<username>_eval_top.v` provided in

`\<project_dir>\pci_master_target_eval\<username>\src\top`

supports the ability to implement the PCI Express core in isolation. Push-button implementation of this top-level design with either Synplify or Precision RTL Synthesis is supported via the project files

`<username>_eval.lfd` (Diamond) or `.syn` (ispLEVER) located in the

`\<project_dir>\pci_master_target_eval\<username>\impl\synplify`

and the

`\<project_dir>\pci_master_target_eval\<username>\impl\precision` directories, respectively.

To use this project file in Diamond:

1. Choose **File > Open > Project**.
2. Browse to `\<project_dir>\pci_master_target_eval\<username>\impl\` (synplify or precision) in the Open Project dialog box.
3. Select and open `<username>.lfd`. At this point, all of the files needed to support top-level synthesis and implementation will be imported to the project.
4. Select the **Process** tab in the left-hand GUI window.
5. Implement the complete design via the standard Diamond GUI flow.

To use this project file in ispLEVER:

1. Choose **File > Open Project**.
2. Browse to `\<project_dir>\pci_master_target_eval\<username>\impl\` (synplify or precision) in the Open Project dialog box.
3. Select and open `<username>.syn`. At this point, all of the files needed to support top-level synthesis and implementation will be imported to the project.
4. Select the device top-level entry in the left-hand GUI window.
5. Implement the complete design via the standard ispLEVER GUI flow.

Hardware Evaluation

The PCI IP core supports Lattice's IP hardware evaluation capability, which makes it possible to create versions of the IP core that operate in hardware for a limited period of time (approximately four hours) without requiring the purchase of an IP license. It may also be used to evaluate the core in hardware in user-defined designs.

Enabling Hardware Evaluation in Diamond

Choose **Project > Active Strategy > Translate Design Settings**. The hardware evaluation capability may be enabled/disabled in the Strategy dialog box. It is enabled by default.

Enabling Hardware Evaluation in ispLEVER

In the Processes for Current Source pane, right-click the **Build Database** process and choose **Properties** from the dropdown menu. The hardware evaluation capability may be enabled/disabled in the Properties dialog box. It is enabled by default.

Updating/Regenerating the IP Core

By regenerating an IP core with the IPexpress tool, you can modify any of its settings including device type, design entry method, and any of the options specific to the IP core. Regenerating can be done to modify an existing IP core or to create a new but similar one.

Regenerating an IP Core in Diamond

To regenerate an IP core in Diamond:

1. In IPexpress, click the **Regenerate** button.
2. In the Regenerate view of IPexpress, choose the IPX source file of the module or IP you wish to regenerate.
3. IPexpress shows the current settings for the module or IP in the Source box. Make your new settings in the **Target** box.
4. If you want to generate a new set of files in a new location, set the new location in the **IPX Target File** box. The base of the file name will be the base of all the new file names. The IPX Target File must end with an .ipx extension.
5. Click **Regenerate**. The module's dialog box opens showing the current option settings.
6. In the dialog box, choose the desired options. To get information about the options, click **Help**. Also, check the About tab in IPexpress for links to technical notes and user guides. IP may come with additional information. As the options change, the schematic diagram of the module changes to show the I/O and the device resources the module will need.
7. To import the module into your project, if it's not already there, select **Import IPX to Diamond Project** (not available in stand-alone mode).
8. Click **Generate**.
9. Check the Generate Log tab to check for warnings and error messages.
10. Click **Close**.

The IPexpress package file (.ipx) supported by Diamond holds references to all of the elements of the generated IP core required to support simulation, synthesis and implementation. The IP core may be included in a user's design by importing the .ipx file to the associated Diamond project. To change the option settings of a module or IP that is already in a design project, double-click the module's .ipx file in the File List view. This opens IPexpress and the module's dialog box showing the current option settings. Then go to step 6 above.

Regenerating an IP Core in ispLEVER

To regenerate an IP core in ispLEVER:

1. In the IPexpress tool, choose **Tools > Regenerate IP/Module**.
2. In the Select a Parameter File dialog box, choose the Lattice Parameter Configuration (.lpc) file of the IP core you wish to regenerate, and click **Open**.
3. The Select Target Core Version, Design Entry, and Device dialog box shows the current settings for the IP core in the Source Value box. Make your new settings in the Target Value box.

4. If you want to generate a new set of files in a new location, set the location in the LPC Target File box. The base of the .lpc file name will be the base of all the new file names. The LPC Target File must end with an .lpc extension.
5. Click **Next**. The IP core's dialog box opens showing the current option settings.
6. In the dialog box, choose desired options. To get information about the options, click **Help**. Also, check the About tab in the IPexpress tool for links to technical notes and user guides. The IP core might come with additional information. As the options change, the schematic diagram of the IP core changes to show the I/O and the device resources the IP core will need.
7. Click **Generate**.
8. Click the **Generate Log** tab to check for warnings and error messages.

This chapter contains information about Lattice Technical Support, additional references, and document revision history.

Lattice Technical Support

There are a number of ways to receive technical support.

Online Forums

The first place to look is Lattice Forums (<http://www.latticesemi.com/support/forums.cfm>). Lattice Forums contain a wealth of knowledge and are actively monitored by Lattice Applications Engineers.

Telephone Support Hotline

Receive direct technical support for all Lattice products by calling Lattice Applications from 5:30 a.m. to 6 p.m. Pacific Time.

- For USA & Canada: 1-800-LATTICE (528-8423)
- For other locations: +1 503 268 8001

In Asia, call Lattice Applications from 8:30 a.m. to 5:30 p.m. Beijing Time (CST), +0800 UTC. Chinese and English language only.

- For Asia: +86 21 52989090

E-mail Support

- techsupport@latticesemi.com
- techsupport-asia@latticesemi.com

Local Support

Contact your nearest Lattice Sales Office.

Internet

www.latticesemi.com

PCI-SIG Website

The Peripheral Component Interconnect Special Interest Group (PCI-SIG) website contains specifications and documents referred to in this user's guide. The PCI-SIG URL is:

<http://www.pcisig.com>.

References

LatticeEC/ECP

- [HB1000](#), *LatticeEC/ECP Family Handbook*

LatticeECP2M

- [HB1003](#), *LatticeECP2M Family Handbook*

LatticeECP3

- [HB1009](#), *LatticeECP3 Family Handbook*

LatticeSC/M

- [DS1004](#), *LatticeSC/M Family Data Sheet*

LatticeXP

- [HB1001](#), *LatticeXP Family Handbook*

LatticeXP2

- [DS1009](#), *Lattice XP2 Datasheet*

MachXO

- [DS1002](#), *MachXO Family Datasheet*

MachXO2

- [DS1035](#), *MachXO2 Family Datasheet*

Revision History

Date	Document Version	IP Version	Change Summary
—	—	5.2	Previous Lattice releases.
August 2006	08.3	5.2	Core version 5.2 - IPexpress User-Configurable flow supported for LatticeECP/EC, LatticeECP2, LatticeSC, LatticeXP, and MachXO only.
September 2006	08.4	5.2	Added Parameter Descriptions section.
December 2006	08.5	5.2	Updated appendices. Added LatticeECP2M appendix.
April 2007	08.6	5.2	Updated references to PCI Local Bus Specification from revision 2.2 to revision 3.0. Updated Command Register figure and table. Replaced “stepping control” with “reserved bit”.
May 2007	08.7	5.2	Updated BAR Mapped to Memory Space section. Updated command9:0 signal description in the Local Interface Signals table. Added support for LatticeXP2 FPGA family.
November 2007	08.8	5.2	Updated appendices.
July 2008	08.9	6.1	Updated appendices.
July 2009	09.0	6.1	Added support for LatticeECP3 FPGA family.
July 2010	09.1	6.2	Divided document into chapters. Added table of contents. Added Quick Facts table in Chapter 1 , “Introduction.” Added new content in Chapter 4 , “IP Core Generation.”
November 2010	09.2	6.4	Added support for Diamond software throughout. Added support for MachXO2 device family throughout.

Resource Utilization

This appendix gives resource utilization information for Lattice FPGAs using the PCI IP core.

IPexpress is the Lattice IP configuration utility, and is included as a standard feature of the Diamond and ispLEVER design tools. Details regarding the usage of IPexpress can be found in the IPexpress and Diamond or ispLEVER help system. For more information on the Diamond or ispLEVER design tools, visit the Lattice web site at: www.latticesemi.com/software.

LatticeECP and LatticeEC FPGAs

Table A-1. Performance and Resource Utilization¹

IPexpress User-Configurable Mode	SLICES	LUTs	Registers	sysMEM™ EBRs	External Pins (PCI Interface)	f _{MAX}
Target 33 MHz, 32-bit PCI/Local/Address bus width	586	703	472	0	48	33
Target 33 MHz, 64-bit PCI/Local/Address bus width	715	913	594	0	87	33
Target 66 MHz, 32-bit PCI/Local/Address bus width	606	966	493	0	48	66
Target 66 MHz, 64-bit PCI/Local/Address bus width	832	1344	614	0	87	66
Master/Target 33 MHz, 32-bit PCI/Local/Address bus width	846	1060	642	0	50	33
Master/Target 33 MHz, 64-bit PCI/Local/Address bus width	1153	1549	849	0	89	33
Master/Target 66 MHz, 32-bit PCI/Local/Address bus width	1083	1690	663	0	50	66
Master/Target 66 MHz, 64-bit PCI/Local/Address bus width	1599	2569	869	0	89	66

1. Performance and utilization data are generated using an LFEC33E-5F672C device with Lattice Diamond 1.0 software. Performance may vary when using a different software version or targeting a different device density or speed grade within the LatticeECP/EC family.

Ordering Part Number

Table A-2 lists the Ordering Part Number (OPNs) for each mode of operation supported by the PCI IP core for LatticeECP/EC.

Table A-2. OPN for LatticeECP/EC PCI IP Core

Speed	PCI Bus	Type	OPN
33 MHz	32-bit	Target	PCI-T32-E2-U6
33 MHz	64-bit	Target	PCI-T64-E2-U6
66 MHz	32-bit	Target	PCI-T32-E2-U6
66 MHz	64-bit	Target	PCI-T64-E2-U6
33 MHz	32-bit	Master/Target	PCI-MT32-E2-U6
33 MHz	64-bit	Master/Target	PCI-MT64-E2-U6
66 MHz	32-bit	Master/Target	PCI-MT32-E2-U6
66 MHz	64-bit	Master/Target	PCI-MT64-E2-U6

LatticeECP2 FPGAs

Table A-3. Performance and Resource Utilization¹

IPexpress User-Configurable Mode	SLICES	LUTs	Registers	sysMEM EBRs	External Pins (PCI Interface)	f _{MAX}
Target 33 MHz, 32-bit PCI/ Local/Address bus width	593	717	472	0	48	33
Target 33 MHz, 64-bit PCI/ Local/Address bus width	722	927	594	0	87	33
Target 66 MHz, 32-bit PCI/ Local/Address bus width	606	972	493	0	48	66
Target 66 MHz, 64-bit PCI/ Local/Address bus width	832	1350	614	0	87	66
Master/Target 33 MHz, 32-bit PCI/ Local/Address bus width	856	1068	642	0	50	33
Master/Target 33 MHz, 64-bit PCI/ Local/Address bus width	1168	1561	849	0	89	33
Master/Target 66 MHz, 32-bit PCI/ Local/Address bus width	1086	1700	663	0	50	66
Master/Target 66 MHz, 64-bit PCI/ Local/Address bus width	1598	2580	869	0	89	66

1. Performance and utilization data are generated using an LFE2-20E-6F672C device with Lattice Diamond 1.0 software. Performance may vary when using a different software version or targeting a different device density or speed grade within the LatticeECP2 family.

Ordering Part Number

Table A-4 lists the Ordering Part Number (OPNs) for each mode of operation supported by the PCI IP core for LatticeECP2.

Table A-4. OPN for LatticeECP2 PCI IP Core

Speed	PCI Bus	Type	OPN
33 MHz	32-bit	Target	PCI-T32-P2-U6
33 MHz	64-bit	Target	PCI-T64-P2-U6
66 MHz	32-bit	Target	PCI-T32-P2-U6
66 MHz	64-bit	Target	PCI-T64-P2-U6
33 MHz	32-bit	Master/Target	PCI-MT32-P2-U6
33 MHz	64-bit	Master/Target	PCI-MT64-P2-U6
66 MHz	32-bit	Master/Target	PCI-MT32-P2-U6
66 MHz	64-bit	Master/Target	PCI-MT64-P2-U6

LatticeECP2M FPGAs

Table A-5. Performance and Resource Utilization¹

IPexpress User-Configurable Mode	SLICES	LUTs	Registers	sysMEM EBRs	External Pins (PCI Interface)	f _{MAX}
Target 33 MHz, 32-bit PCI/ Local/Address bus width	593	717	472	0	48	33
Target 33 MHz, 64-bit PCI/ Local/Address bus width	722	927	594	0	87	33
Target 66 MHz, 32-bit PCI/ Local/Address bus width	606	972	493	0	48	66
Target 66 MHz, 64-bit PCI/ Local/Address bus width	832	1350	614	0	87	66
Master/Target 33 MHz, 32-bit PCI/ Local/Address bus width	856	1068	642	0	50	33
Master/Target 33 MHz, 64-bit PCI/ Local/Address bus width	1168	1561	849	0	89	33
Master/Target 66 MHz, 32-bit PCI/ Local/Address bus width	1086	1700	663	0	50	66
Master/Target 66 MHz, 64-bit PCI/ Local/Address bus width	1598	2580	869	0	89	66

1. Performance and utilization data are generated using an LFE2M-35E-6F672C device with Lattice Diamond 1.0 software. Performance may vary when using a different software version or targeting a different device density or speed grade within the LatticeECP2M family.

Ordering Part Number

Table A-6 lists the Ordering Part Number (OPNs) for each mode of operation supported by the PCI IP core for LatticeECP2M.

Table A-6. OPN for LatticeECP2M PCI IP Core

Speed	PCI Bus	Type	OPN
33 MHz	32-bit	Target	PCI-T32-PM-U6
33 MHz	64-bit	Target	PCI-T64-PM-U6
66 MHz	32-bit	Target	PCI-T32-PM-U6
66 MHz	64-bit	Target	PCI-T64-PM-U6
33 MHz	32-bit	Master/Target	PCI-MT32-PM-U6
33 MHz	64-bit	Master/Target	PCI-MT64-PM-U6
66 MHz	32-bit	Master/Target	PCI-MT32-PM-U6
66 MHz	64-bit	Master/Target	PCI-MT64-PM-U6

LatticeECP3 FPGAs

Table A-7. Performance and Resource Utilization¹

IPexpress User-Configurable Mode	SLICES	LUTs	Registers	sysMEM EBRs	External Pins (PCI Interface)	f _{MAX}
Target 33 MHz, 32-bit PCI/Local/Address bus width	483	706	470	0	48	33
Target 33 MHz, 64-bit PCI/Local/Address bus width	612	918	592	0	87	33
Target 66 MHz, 32-bit PCI/Local/Address bus width	589	963	491	0	48	66
Target 66 MHz, 64-bit PCI/Local/Address bus width	809	1341	612	0	87	66
Master/Target 33 MHz, 32-bit PCI/Local/Address bus width	683	1059	640	0	50	33
Master/Target 33 MHz, 64-bit PCI/Local/Address bus width	1005	1552	847	0	89	33
Master/Target 66 MHz, 32-bit PCI/Local/Address bus width	1076	1691	661	0	50	66
Master/Target 66 MHz, 64-bit PCI/Local/Address bus width	1550	2570	867	0	89	66

1. Performance and utilization data are generated using an LFE3-95EA-7FN1156CES device with Lattice Diamond 1.0 software. Performance may vary when using a different software version or targeting a different device density or speed grade within the LatticeECP3 family.

Ordering Part Number

Table A-8 lists the Ordering Part Number (OPNs) for each mode of operation supported by the PCI IP core for LatticeECP3.

Table A-8. OPN for LatticeECP3 PCI IP Core

Speed	PCI Bus	Type	OPN
33 MHz	32-bit	Target	PCI-T32-E3-U6
33 MHz	64-bit	Target	PCI-T64-E3-U6
66 MHz	32-bit	Target	PCI-T32-E3-U6
66 MHz	64-bit	Target	PCI-T64-E3-U6
33 MHz	32-bit	Master/Target	PCI-MT32-E3-U6
33 MHz	64-bit	Master/Target	PCI-MT64-E3-U6
66 MHz	32-bit	Master/Target	PCI-MT32-E3-U6
66 MHz	64-bit	Master/Target	PCI-MT64-E3-U6

LatticeXP FPGAs

Table A-9. Performance and Resource Utilization¹

IPexpress User-Configurable Mode	SLICES	LUTs	Registers	sysMEM EBRs	External Pins (PCI Interface)	f _{MAX}
Target 33 MHz, 32-bit PCI/ Local/Address bus width	586	703	472	0	48	33
Target 33 MHz, 64-bit PCI/ Local/Address bus width	715	913	594	0	87	33
Target 66 MHz, 32-bit PCI/ Local/Address bus width	606	966	493	0	48	66
Target 66 MHz, 64-bit PCI/ Local/Address bus width	832	1344	614	0	87	66
Master/Target 33 MHz, 32-bit PCI/ Local/Address bus width	846	1060	642	0	50	33
Master/Target 33 MHz, 64-bit PCI/ Local/Address bus width	1090	1549	849	0	89	33
Master/Target 66 MHz, 32-bit PCI/ Local/Address bus width	1083	1690	663	0	50	66

1. Performance and utilization data are generated using an LFXP20C-5F484C device with Lattice Diamond 1.0 software. Performance may vary when using a different software version or targeting a different device density or speed grade within the LatticeXP family.

Ordering Part Number

Table A-10 lists the Ordering Part Number (OPNs) for each mode of operation supported by the PCI IP core for LatticeXP.

Table A-10. OPN for LatticeXP PCI IP Core

Speed	PCI Bus	Type	OPN
33 MHz	32-bit	Target	PCI-T32-XM-U6
33 MHz	64-bit	Target	PCI-T64-XM-U6
66 MHz	32-bit	Target	PCI-T32-XM-U6
66 MHz	64-bit	Target	PCI-T64-XM-U6
33 MHz	32-bit	Master/Target	PCI-MT32-XM-U6
33 MHz	64-bit	Master/Target	PCI-MT64-XM-U6
66 MHz	32-bit	Master/Target	PCI-MT32-XM-U6
66 MHz	64-bit	Master/Target	PCI-MT64-XM-U6

LatticeXP2 FPGAs

Table A-11. Performance and Resource Utilization¹

IPexpress User-Configurable Mode	SLICES	LUTs	Registers	sysMEM EBRs	External Pins (PCI Interface)	f _{MAX}
Target 33 MHz, 32-bit PCI/ Local/Address bus width	588	709	470	0	48	33
Target 33 MHz, 64-bit PCI/ Local/Address bus width	707	919	592	0	87	33
Target 66 MHz, 32-bit PCI/ Local/Address bus width	601	964	491	0	48	66
Target 66 MHz, 64-bit PCI/ Local/Address bus width	827	1342	612	0	87	66
Master/Target 33 MHz, 32-bit PCI/ Local/Address bus width	851	1060	640	0	50	33
Master/Target 33 MHz, 64-bit PCI/ Local/Address bus width	1100	1553	847	0	89	33
Master/Target 66 MHz, 32-bit PCI/ Local/Address bus width	1081	1692	661	0	50	66
Master/Target 66 MHz, 64-bit PCI/ Local/Address bus width	1530	2572	867	0	89	66

1. Performance and utilization data are generated using an LFXP2-17E-6F484C device with Lattice Diamond 1.0 software. Performance may vary when using a different software version or targeting a different device density or speed grade within the LatticeXP2 family.

Ordering Part Number

Table A-12 lists the Ordering Part Number (OPNs) for each mode of operation supported by the PCI IP core for LatticeXP2.

Table A-12. OPN for LatticeXP2 PCI IP Core

Speed	PCI Bus	Type	OPN
33 MHz	32-bit	Target	PCI-T32-X2-U6
33 MHz	64-bit	Target	PCI-T64-X2-U6
66 MHz	32-bit	Target	PCI-T32-X2-U6
66 MHz	64-bit	Target	PCI-T64-X2-U6
33 MHz	32-bit	Master/Target	PCI-MT32-X2-U6
33 MHz	64-bit	Master/Target	PCI-MT64-X2-U6
66 MHz	32-bit	Master/Target	PCI-MT32-X2-U6
66 MHz	64-bit	Master/Target	PCI-MT64-X2-U6

MachXO FPGAs

Table A-13. Performance and Resource Utilization¹

IPexpress User-Configurable Mode	SLICES	LUTs	Registers	sysMEM EBRs	External Pins (PCI Interface)	f _{MAX}
Target 33 MHz, 32-bit PCI/Local/Address bus width	359	703	472	0	48	33
Target 66 MHz, 32-bit PCI/Local/Address bus width	517	966	493	0	48	66
Master/Target 33 MHz, 32-bit PCI/Local/Address bus width	542	1060	642	0	50	33

1. Performance and utilization data are generated using an LCMXO2280C-5FT324C device with Lattice Diamond 1.0 software. Performance may vary when using a different software version or targeting a different device density or speed grade within the MachXO family.

Ordering Part Number

Table A-14 lists the Ordering Part Number (OPNs) for each mode of operation supported by the PCI IP core for MachXO.

Table A-14. MachXO OPN for PCI IP Core

Speed	PCI Bus	Type	OPN
33 MHz	32-bit	Target	PCI-T32-XO-U6
66 MHz	32-bit	Target	PCI-T32-XO-U6
33 MHz	32-bit	Master/Target	PCI-MT32-XO-U6

MachXO2 FPGAs

Table A-15. Performance and Resource Utilization¹

IPexpress User-Configurable Mode	SLICES	LUTs	Registers	sysMEM EBRs	External Pins (PCI Interface)	f _{MAX}
Target 33 MHz, 32-bit PCI/Local/Address bus width	304	601	422	0	48	33
Master/Target 33 MHz, 32-bit PCI/Local/Address bus width	406	803	582	0	50	33

1. Performance and utilization data are generated using an LCMXO2-1200HC-6TG144CES device with Lattice Diamond 1.0 software. Performance may vary when using a different software version or targeting a different device density or speed grade within the MachXO2 family.

Ordering Part Number

Table A-16 lists the Ordering Part Number (OPNs) for each mode of operation supported by the PCI IP core for MachXO2.

Table A-16. OPN for MachXO2 PCI IP Core

Speed	PCI Bus	Type	OPN
33 MHz	32-bit	Target	PCI-T32-M2-U1
33 MHz	32-bit	Master/Target	PCI-MT32-M2-U1

LatticeSC FPGAs

Table A-17. Performance and Resource Utilization¹

IPexpress User-Configurable Mode	SLICES	LUTs	Registers	sysMEM EBRs	External Pins (PCI Interface)	f _{MAX}
Target 33 MHz, 32-bit PCI/Local/Address bus width	488	679	470	0	48	33
Target 33 MHz, 64-bit PCI/Local/Address bus width	621	893	594	0	87	33
Target 66 MHz, 32-bit PCI/Local/Address bus width	618	990	493	0	48	66
Target 66 MHz, 64-bit PCI/Local/Address bus width	845	1391	622	0	87	66
Master/Target 33 MHz, 32-bit PCI/Local/Address bus width	724	1050	640	0	50	33
Master/Target 33 MHz, 64-bit PCI/Local/Address bus width	986	1529	850	0	89	33
Master/Target 66 MHz, 32-bit PCI/Local/Address bus width	1085	1722	663	0	50	66
Master/Target 66 MHz, 64-bit PCI/Local/Address bus width	1513	2631	871	0	89	66

1. Performance and utilization data are generated using an LFSC3GA25E-6F900C device with Lattice Diamond 1.0 software. Performance may vary when using a different software version or targeting a different device density or speed grade within the LatticeSC family.

Ordering Part Number

Table A-18 lists the Ordering Part Number (OPNs) for each mode of operation supported by the PCI IP core for LatticeSC.

Table A-18. OPN for LatticeSC PCI IP Core

Speed	PCI Bus	Type	OPN
33 MHz	32-bit	Target	PCI-T32-SC-U6
33 MHz	64-bit	Target	PCI-T64-SC-U6
66 MHz	32-bit	Target	PCI-T32-SC-U6
66 MHz	64-bit	Target	PCI-T64-SC-U6
33 MHz	32-bit	Master/Target	PCI-MT32-SC-U6
33 MHz	64-bit	Master/Target	PCI-MT64-SC-U6
66 MHz	32-bit	Master/Target	PCI-MT32-SC-U6
66 MHz	64-bit	Master/Target	PCI-MT64-SC-U6

Pin Assignments For Lattice FPGAs

Pin Assignment Considerations for LatticeECP and LatticeEC Devices

PCI Pin Assignments for Master/Target 33MHz 64-Bit Bus

The PCI Master/Target 33MHz 64-bit core is optimized for LFEC33E-5F672C. An example assignment, optimized for best performance, is given in [Table B-1](#). In the IPexpress user-configurable design flow, actual pin assignment is contained with the .lpf preference file. Refer to the readme file included with the core package for further information.

Table B-1. PCI Pins Assignments

Signal Name	Pin/Bank	Buffer Type
PCI System Pins		
clk	W1/6	LVC MOS33_IN
rstn	Y8/5	PCI33_IN
PCI Address and Data		
ad[0]	AB13/5	PCI33_BIDI
ad[1]	AC10/5	PCI33_BIDI
ad[2]	AD10/5	PCI33_BIDI
ad[3]	AA9/5	PCI33_BIDI
ad[4]	AB9/5	PCI33_BIDI
ad[5]	AC9/5	PCI33_BIDI
ad[6]	AD9/5	PCI33_BIDI
ad[7]	AA8/5	PCI33_BIDI
ad[8]	AB8/5	PCI33_BIDI
ad[9]	AC8/5	PCI33_BIDI
ad[10]	AD8/5	PCI33_BIDI
ad[11]	AE8/5	PCI33_BIDI
ad[12]	AF8/5	PCI33_BIDI
ad[13]	AA7/5	PCI33_BIDI
ad[14]	AB7/5	PCI33_BIDI
ad[15]	AC7/5	PCI33_BIDI
ad[16]	AD7/5	PCI33_BIDI
ad[17]	AE7/5	PCI33_BIDI
ad[18]	AF7/5	PCI33_BIDI
ad[19]	AC6/5	PCI33_BIDI
ad[20]	AD6/5	PCI33_BIDI
ad[21]	AE6/5	PCI33_BIDI
ad[22]	AF6/5	PCI33_BIDI
ad[23]	AC5/5	PCI33_BIDI
ad[24]	AD5/5	PCI33_BIDI
ad[25]	AE5/5	PCI33_BIDI
ad[26]	AF5/5	PCI33_BIDI
ad[27]	AE4/5	PCI33_BIDI
ad[28]	AF4/5	PCI33_BIDI
ad[29]	AE3/5	PCI33_BIDI

Table B-1. PCI Pins Assignments (Continued)

Signal Name	Pin/Bank	Buffer Type
ad[30]	AF3/5	PCI33_BIDI
ad[31]	AE2/5	PCI33_BIDI
ad[32]	AF24/4	PCI33_BIDI
ad[33]	AF23/4	PCI33_BIDI
ad[34]	AE23/4	PCI33_BIDI
ad[35]	AF22/4	PCI33_BIDI
ad[36]	AE22/4	PCI33_BIDI
ad[37]	AF21/4	PCI33_BIDI
ad[38]	AE21/4	PCI33_BIDI
ad[39]	AF20/4	PCI33_BIDI
ad[40]	AE20/4	PCI33_BIDI
ad[41]	AF19/4	PCI33_BIDI
ad[42]	AE19/4	PCI33_BIDI
ad[43]	AF18/4	PCI33_BIDI
ad[44]	AE18/4	PCI33_BIDI
ad[45]	AD18/4	PCI33_BIDI
ad[46]	AC18/4	PCI33_BIDI
ad[47]	AB18/4	PCI33_BIDI
ad[48]	AA18/4	PCI33_BIDI
ad[49]	AF17/4	PCI33_BIDI
ad[50]	AD17/4	PCI33_BIDI
ad[51]	AC17/4	PCI33_BIDI
ad[52]	AB17/4	PCI33_BIDI
ad[53]	AA17/4	PCI33_BIDI
ad[54]	AF16/4	PCI33_BIDI
ad[55]	AE16/4	PCI33_BIDI
ad[56]	AD16/4	PCI33_BIDI
ad[57]	AC16/4	PCI33_BIDI
ad[58]	AB16/4	PCI33_BIDI
ad[59]	AA16/4	PCI33_BIDI
ad[60]	Y16/4	PCI33_BIDI
ad[61]	AD15/4	PCI33_BIDI
ad[62]	AA15/4	PCI33_BIDI
ad[63]	Y15/4	PCI33_BIDI
cben[0]	AA10/5	PCI33_BIDI
cben[1]	AC11/5	PCI33_BIDI
cben[2]	AD11/5	PCI33_BIDI
cben[3]	AF9/5	PCI33_BIDI
cben[4]	AF12/5	PCI33_BIDI
cben[5]	AF11/5	PCI33_BIDI
cben[6]	AE11/5	PCI33_BIDI
cben[7]	AA11/5	PCI33_BIDI
par	AF10/5	PCI33_BIDI
par64	AB11/5	PCI33_BIDI

Table B-1. PCI Pins Assignments (Continued)

Signal Name	Pin/Bank	Buffer Type
PCI Interface Controls		
Framen	AA12/5	PCI33_BIDI
irdyn	AB12/5	PCI33_BIDI
trdyn	AC12/5	PCI33_BIDI
stopn	AE12/5	PCI33_BIDI
ldsel	AB6/5	PCI33_IN
devseln	AD12/5	PCI33_BIDI
perrn	AE9/5	PCI33_BIDI
serrn	AE10/5	PCI33_BIDI
ack64n	AE13/5	PCI33_BIDI
req64n	AF13/5	PCI33_BIDI
PCI Interrupts		
intan	AA6/5	PCI33_OUT
PCI Bus Arbitration		
gntn	AF2/5	PCI33_IN
reqn	AD4/5	PCI33_OUT

PCI Pin Assignments for Target 66MHz 64-Bit Bus

The PCI Target 33MHz 64-bit core is optimized for LFEC33E-5F672C. An example pin assignment, optimized for best performance, is given in [Table B-2](#). Refer to the readme file included with the core package for further information.

Table B-2. PCI Pins Assignments

Signal Name	Pin/Bank	I/O Type
PCI System Pins		
clk	W1/6	LVC MOS33_IN
rstn	Y8/5	PCI33_IN
PCI Address and Data		
ad[0]	AB10/5	PCI33_BIDI
ad[1]	AC10/5	PCI33_BIDI
ad[2]	AD10/5	PCI33_BIDI
ad[3]	AA9/5	PCI33_BIDI
ad[4]	AB9/5	PCI33_BIDI
ad[5]	AC9/5	PCI33_BIDI
ad[6]	AD9/5	PCI33_BIDI
ad[7]	AA8/5	PCI33_BIDI
ad[8]	AB8/5	PCI33_BIDI
ad[9]	AC8/5	PCI33_BIDI
ad[10]	AD8/5	PCI33_BIDI
ad[11]	AE8/5	PCI33_BIDI
ad[12]	AF8/5	PCI33_BIDI
ad[13]	AA7/5	PCI33_BIDI
ad[14]	AB7/5	PCI33_BIDI
ad[15]	AC7/5	PCI33_BIDI
ad[16]	AD7/5	PCI33_BIDI

Table B-2. PCI Pins Assignments (Continued)

Signal Name	Pin/Bank	I/O Type
ad[17]	AE7/5	PCI33_BIDI
ad[18]	AF7/5	PCI33_BIDI
ad[19]	AC6/5	PCI33_BIDI
ad[20]	AD6/5	PCI33_BIDI
ad[21]	AE6/5	PCI33_BIDI
ad[22]	AF6/5	PCI33_BIDI
ad[23]	AC5/5	PCI33_BIDI
ad[24]	AD5/5	PCI33_BIDI
ad[25]	AE5/5	PCI33_BIDI
ad[26]	AF5/5	PCI33_BIDI
ad[27]	AE4/5	PCI33_BIDI
ad[28]	AF4/5	PCI33_BIDI
ad[29]	AE3/5	PCI33_BIDI
ad[30]	AF3/5	PCI33_BIDI
ad[31]	AE2/5	PCI33_BIDI
ad[32]	AF24/4	PCI33_BIDI
ad[33]	AF23/4	PCI33_BIDI
ad[34]	AE23/4	PCI33_BIDI
ad[35]	AF22/4	PCI33_BIDI
ad[36]	AE22/4	PCI33_BIDI
ad[37]	AF21/4	PCI33_BIDI
ad[38]	AE21/4	PCI33_BIDI
ad[39]	AF20/4	PCI33_BIDI
ad[40]	AE20/4	PCI33_BIDI
ad[41]	AF19/4	PCI33_BIDI
ad[42]	AE19/4	PCI33_BIDI
ad[43]	AF18/4	PCI33_BIDI
ad[44]	AE18/4	PCI33_BIDI
ad[45]	AD18/4	PCI33_BIDI
ad[46]	AC18/4	PCI33_BIDI
ad[47]	AB18/4	PCI33_BIDI
ad[48]	AA18/4	PCI33_BIDI
ad[49]	AF17/4	PCI33_BIDI
ad[50]	AD17/4	PCI33_BIDI
ad[51]	AC17/4	PCI33_BIDI
ad[52]	AB17/4	PCI33_BIDI
ad[53]	AA17/4	PCI33_BIDI
ad[54]	AF16/4	PCI33_BIDI
ad[55]	AE16/4	PCI33_BIDI
ad[56]	AD16/4	PCI33_BIDI
ad[57]	AC16/4	PCI33_BIDI
ad[58]	AB16/4	PCI33_BIDI
ad[59]	AA16/4	PCI33_BIDI
ad[60]	Y16/4	PCI33_BIDI

Table B-2. PCI Pins Assignments (Continued)

Signal Name	Pin/Bank	I/O Type
ad[61]	AD15/4	PCI33_BIDI
ad[62]	AA15/4	PCI33_BIDI
ad[63]	Y15/4	PCI33_BIDI
cben[0]	AA10/5	PCI33_IN
cben[1]	AC11/5	PCI33_IN
cben[2]	AD11/5	PCI33_IN
cben[3]	AF9/5	PCI33_IN
cben[4]	AF12/5	PCI33_IN
cben[5]	AF11/5	PCI33_IN
cben[6]	AE11/5	PCI33_IN
cben[7]	AA11/5	PCI33_IN
par64	AB11/5	PCI33_BIDI
par	AF10/5	PCI33_BIDI
PCI Interface Controls		
Framen	AA12/5	PCI33_IN
irdyn	AB12/5	PCI33_IN
trdyn	AC12/5	PCI33_OUT
Stopn	AE12/5	PCI33_OUT
ldsel	AB6/5	PCI33_IN
devseln	AD12/5	PCI33_OUT
perrn	AE9/5	PCI33_OUT
serrn	AE10/5	PCI33_OUT
ack64n	AE13/5	PCI33_OUT
req64n	AF13/5	PCI33_IN
PCI Interrupts		
intan	AA6/5	PCI33_OUT

PCI Pin Assignments for Master/Target 33MHz 32-Bit Bus

The PCI Master/Target 33MHz 32-bit core is optimized for LFEC33E-5F672C. An example pin assignment, optimized for best performance, is given in [Table B-3](#). Refer to the readme file included with the core package for further information.

Table B-3. PCI Pins Assignments

Signal Name	Pin/Bank	Buffer Type
PCI System Pins		
clk	W1/6	LVC MOS33_IN
rstn	Y8/5	PCI33_IN
PCI Address and Data		
ad[0]	AB10/5	PCI33_BIDI
ad[1]	AC10/5	PCI33_BIDI
ad[2]	AD10/5	PCI33_BIDI
ad[3]	AA9/5	PCI33_BIDI
ad[4]	AB9/5	PCI33_BIDI
ad[5]	AC9/5	PCI33_BIDI
ad[6]	AD9/5	PCI33_BIDI

Table B-3. PCI Pins Assignments (Continued)

Signal Name	Pin/Bank	Buffer Type
ad[7]	AA8/5	PCI33_BIDI
ad[8]	AB8/5	PCI33_BIDI
ad[9]	AC8/5	PCI33_BIDI
ad[10]	AD8/5	PCI33_BIDI
ad[11]	AE8/5	PCI33_BIDI
ad[12]	AF8/5	PCI33_BIDI
ad[13]	AA7/5	PCI33_BIDI
ad[14]	AB7/5	PCI33_BIDI
ad[15]	AC7/5	PCI33_BIDI
ad[16]	AD7/5	PCI33_BIDI
ad[17]	AE7/5	PCI33_BIDI
ad[18]	AF7/5	PCI33_BIDI
ad[19]	AC6/5	PCI33_BIDI
ad[20]	AD6/5	PCI33_BIDI
ad[21]	AE6/5	PCI33_BIDI
ad[22]	AF6/5	PCI33_BIDI
ad[23]	AC5/5	PCI33_BIDI
ad[24]	AD5/5	PCI33_BIDI
ad[25]	AE5/5	PCI33_BIDI
ad[26]	AF5/5	PCI33_BIDI
ad[27]	AE4/5	PCI33_BIDI
ad[28]	AF4/5	PCI33_BIDI
ad[29]	AE3/5	PCI33_BIDI
ad[30]	AF3/5	PCI33_BIDI
ad[31]	AE2/5	PCI33_BIDI
cben[0]	AA10/5	PCI33_BIDI
cben[1]	AC11/5	PCI33_BIDI
cben[2]	AD11/5	PCI33_BIDI
cben[3]	AF9/5	PCI33_BIDI
Par	AF10/5	PCI33_BIDI
PCI Interface Controls		
Framen	AA12/5	PCI33_BIDI
irdyn	AB12/5	PCI33_BIDI
trdyn	AC12/5	PCI33_BIDI
stopn	AE12/5	PCI33_BIDI
ldsel	AB6/5	PCI33_IN
devseln	AD12/5	PCI33_BIDI
perrn	AE9/5	PCI33_BIDI
serrn	AE10/5	PCI33_BIDI
PCI Interrupts		
intan	AA6/5	PCI33_OUT
PCI Bus Arbitration		
gntn	AF2/5	PCI33_IN
reqn	AD4/5	PCI33_OUT

PCI Pin Assignments for Target 33MHz 32-Bit Bus

The PCI Target 33MHz 32-bit core is optimized for LFEC33E-5F672C. An example pin assignment, optimized for best performance, is given in [Table B-4](#). Refer to the readme file included with the core package for further information.

Table B-4. PCI Pins Assignments

Signal Name	Pin/ Bank	Buffer Type
PCI System Pins		
clk	W1/6	LVC MOS33_IN
rstn	Y8/5	PCI33_IN
PCI Address and Data		
ad[0]	AB10/5	PCI33_BIDI
ad[1]	AC10/5	PCI33_BIDI
ad[2]	AD10/5	PCI33_BIDI
ad[3]	AA9/5	PCI33_BIDI
ad[4]	AB9/5	PCI33_BIDI
ad[5]	AC9/5	PCI33_BIDI
ad[6]	AD9/5	PCI33_BIDI
ad[7]	AA8/5	PCI33_BIDI
ad[8]	AB8/5	PCI33_BIDI
ad[9]	AC8/5	PCI33_BIDI
ad[10]	AD8/5	PCI33_BIDI
ad[11]	AE8/5	PCI33_BIDI
ad[12]	AF8/5	PCI33_BIDI
ad[13]	AA7/5	PCI33_BIDI
ad[14]	AB7/5	PCI33_BIDI
ad[15]	AC7/5	PCI33_BIDI
ad[16]	AD7/5	PCI33_BIDI
ad[17]	AE7/5	PCI33_BIDI
ad[18]	AF7/5	PCI33_BIDI
ad[19]	AC6/5	PCI33_BIDI
ad[20]	AD6/5	PCI33_BIDI
ad[21]	AE6/5	PCI33_BIDI
ad[22]	AF6/5	PCI33_BIDI
ad[23]	AC5/5	PCI33_BIDI
ad[24]	AD5/5	PCI33_BIDI
ad[25]	AE5/5	PCI33_BIDI
ad[26]	AF5/5	PCI33_BIDI
ad[27]	AE4/5	PCI33_BIDI
ad[28]	AF4/5	PCI33_BIDI
ad[29]	AE3/5	PCI33_BIDI
ad[30]	AF3/5	PCI33_BIDI
ad[31]	AE2/5	PCI33_BIDI
cben[0]	AA10/5	PCI33_BIDI
cben[1]	AC11/5	PCI33_BIDI
cben[2]	AD11/5	PCI33_BIDI

Table B-4. PCI Pins Assignments (Continued)

Signal Name	Pin/ Bank	Buffer Type
cben[3]	AF9/5	PCI33_BIDI
Par	AF10/5	PCI33_BIDI
PCI Interface Controls		
Framen	AA12/5	PCI33_BIDI
irdyn	AB12/5	PCI33_BIDI
trdyn	AC12/5	PCI33_BIDI
stopn	AE12/5	PCI33_BIDI
ldsel	AB6/5	PCI33_IN
devseln	AD12/5	PCI33_BIDI
perrn	AE9/5	PCI33_BIDI
serrn	AE10/5	PCI33_BIDI
PCI Interrupts		
intan	AA6/5	PCI33_OUT

Pin Assignment Considerations for LatticeXP Devices

PCI Pin Assignments for Master/Target 33MHz 32-Bit Bus

The PCI Master/Target 33MHz 32-bit core is optimized for LFXP10-4F388C. An example pin assignment, optimized for best performance, is given in [Table B-5](#). Refer to the readme file included with the core package for further information.

Table B-5. PCI Pins Assignments

Signal Name	Pin/Bank	BufferType
PCI System Pins		
clk	U1/6	LVC MOS33_IN
rstn	AA4/5	PCI33_IN
PCI Address and Data		
ad[0]	AB18/4	PCI33_BIDI
ad[1]	AA18/4	PCI33_BIDI
ad[2]	Y18/4	PCI33_BIDI
ad[3]	AB17/4	PCI33_BIDI
ad[4]	Y14/4	PCI33_BIDI
ad[5]	Y13/4	PCI33_BIDI
ad[6]	AA17/4	PCI33_BIDI
ad[7]	Y17/4	PCI33_BIDI
ad[8]	AB16/4	PCI33_BIDI
ad[9]	AA16/4	PCI33_BIDI
ad[10]	AB15/4	PCI33_BIDI
ad[11]	AA15/4	PCI33_BIDI
ad[12]	W13/4	PCI33_BIDI
ad[13]	W12/4	PCI33_BIDI
ad[14]	AB14/4	PCI33_BIDI
ad[15]	AA14/4	PCI33_BIDI
ad[16]	AA13/4	PCI33_BIDI
ad[17]	AA10/5	PCI33_BIDI

Table B-5. PCI Pins Assignments (Continued)

Signal Name	Pin/Bank	BufferType
ad[18]	Y8/5	PCI33_BIDI
ad[19]	AB8/5	PCI33_BIDI
ad[20]	AA8/5	PCI33_BIDI
ad[21]	Y7/5	PCI33_BIDI
ad[22]	AB7/5	PCI33_BIDI
ad[23]	AA7/5	PCI33_BIDI
ad[24]	Y10/5	PCI33_BIDI
ad[25]	Y9/5	PCI33_BIDI
ad[26]	AB6/5	PCI33_BIDI
ad[27]	AA6/5	PCI33_BIDI
ad[28]	AB5/5	PCI33_BIDI
ad[29]	AA5/5	PCI33_BIDI
ad[30]	AB4/5	PCI33_BIDI
ad[31]	W9/5	PCI33_BIDI
cben[0]	AA19/4	PCI33_BIDI
cben[1]	Y20/4	PCI33_BIDI
cben[2]	W14/4	PCI33_BIDI
cben[3]	W15/4	PCI33_BIDI
PCI Interface Controls		
par	W11/5	PCI33_BIDI
serrn	AB9/5	PCI33_BIDI
perrn	W10/5	PCI33_BIDI
devseln	AB10/5	PCI33_BIDI
framen	AB11/5	PCI33_BIDI
irdyn	Y11/5	PCI33_BIDI
stopn	AA11/5	PCI33_BIDI
trdyn	Y12/5	PCI33_BIDI
gntn	AA12/4	PCI33_BIDI
reqn	AB12/4	PCI33_BIDI
PCI Interrupts		
idsel	AB19/4	PCI33_IN
intan	W6/5	PCI33_OUT

PCI Pin Assignments for Target 33MHz 32-Bit Bus

The PCI Target 33MHz 32-bit core is optimized for LFXP10-4F388C. An example pin assignment, optimized for best performance, is given in Table 63. Refer to the readme file included with the core package for further information.

Table B-6. PCI Pins Assignments

Signal Name	Pin/Bank	Buffer Type
PCI System Pins		
clk	U1/6	LVC MOS33_IN
rstn	AA4/5	PCI33_IN
PCI Address and Data		
ad[0]	AB18/4	PCI33_BIDI

Table B-6. PCI Pins Assignments (Continued)

Signal Name	Pin/Bank	Buffer Type
ad[1]	AA18/4	PCI33_BIDI
ad[2]	Y18/4	PCI33_BIDI
ad[3]	AB17/4	PCI33_BIDI
ad[4]	Y14/4	PCI33_BIDI
ad[5]	Y13/4	PCI33_BIDI
ad[6]	AA17/4	PCI33_BIDI
ad[7]	Y17/4	PCI33_BIDI
ad[8]	AB16/4	PCI33_BIDI
ad[9]	AA16/4	PCI33_BIDI
ad[10]	AB15/4	PCI33_BIDI
ad[11]	AA15/4	PCI33_BIDI
ad[12]	W13/4	PCI33_BIDI
ad[13]	W12/4	PCI33_BIDI
ad[14]	AB14/4	PCI33_BIDI
ad[15]	AA14/4	PCI33_BIDI
ad[16]	AA13/4	PCI33_BIDI
ad[17]	AA10/5	PCI33_BIDI
ad[18]	Y8/5	PCI33_BIDI
ad[19]	AB8/5	PCI33_BIDI
ad[20]	AA8/5	PCI33_BIDI
ad[21]	Y7/5	PCI33_BIDI
ad[22]	AB7/5	PCI33_BIDI
ad[23]	AA7/5	PCI33_BIDI
ad[24]	Y10/5	PCI33_BIDI
ad[25]	Y9/5	PCI33_BIDI
ad[26]	AB6/5	PCI33_BIDI
ad[27]	AA6/5	PCI33_BIDI
ad[28]	AB5/5	PCI33_BIDI
ad[29]	AA5/5	PCI33_BIDI
ad[30]	AB4/5	PCI33_BIDI
ad[31]	W9/5	PCI33_BIDI
cben[0]	AA19/4	PCI33_BIDI
cben[1]	Y20/4	PCI33_BIDI
cben[2]	W14/4	PCI33_BIDI
cben[3]	W15/4	PCI33_BIDI
par	W11/5	PCI33_BIDI
PCI Interface Controls		
serrn	AB9/5	PCI33_BIDI
perrn	W10/5	PCI33_BIDI
devseln	AB10/5	PCI33_BIDI
framen	AB11/5	PCI33_BIDI
irdyn	Y11/5	PCI33_BIDI
stopn	AA11/5	PCI33_BIDI
trdyn	Y12/5	PCI33_BIDI

Table B-6. PCI Pins Assignments (Continued)

Signal Name	Pin/Bank	Buffer Type
idsel	AB19/4	PCI33_IN
PCI Interrupts		
intan	W6/5	PCI33_OUT

PCI Pin Assignments for Master/Target 33MHz 64-Bit Bus

The PCI Master/Target 33MHz 64-bit core is optimized for LFXP20C-4F484C. An example pin assignment, optimized for best performance, is given in [Table B-7](#). Refer to the readme file included with the core package for further information.

Table B-7. PCI Pin Assignments

Signal Name	Pin/Bank	Buffer Type
PCI System Pins		
clk	U2 / 6	LVC MOS33_IN
rstn	Y5 / 5	PCI33_IN
PCI Address and Data		
ad(0)	W13 / 4	PCI33_BIDI
ad(1)	Y13 / 4	PCI33_BIDI
ad(2)	AA13 / 4	PCI33_BIDI
ad(3)	AB13 / 4	PCI33_BIDI
ad(4)	V12 / 4	PCI33_BIDI
ad(5)	W12 / 4	PCI33_BIDI
ad(6)	Y12 / 4	PCI33_BIDI
ad(7)	AA12 / 4	PCI33_BIDI
ad(8)	V11 / 5	PCI33_BIDI
ad(9)	W11 / 5	PCI33_BIDI
ad(10)	Y11 / 5	PCI33_BIDI
ad(11)	AA11 / 5	PCI33_BIDI
ad(12)	AB11 / 5	PCI33_BIDI
ad(13)	V10 / 5	PCI33_BIDI
ad(14)	W10 / 5	PCI33_BIDI
ad(15)	Y10 / 5	PCI33_BIDI
ad(16)	W8 / 5	PCI33_BIDI
ad(17)	Y8 / 5	PCI33_BIDI
ad(18)	AA8 / 5	PCI33_BIDI
ad(19)	AB8 / 5	PCI33_BIDI
ad(20)	U7 / 5	PCI33_BIDI
ad(21)	V7 / 5	PCI33_BIDI
ad(22)	W7 / 5	PCI33_BIDI
ad(23)	Y7 / 5	PCI33_BIDI
ad(24)	Y6 / 5	PCI33_BIDI
ad(25)	AA6 / 5	PCI33_BIDI
ad(26)	AB6 / 5	PCI33_BIDI
ad(27)	AA5 / 5	PCI33_BIDI

Table B-7. PCI Pin Assignments (Continued)

Signal Name	Pin/Bank	Buffer Type
ad(28)	AB5 / 5	PCI33_BIDI
ad(29)	AA4 / 5	PCI33_BIDI
ad(30)	AB4 / 5	PCI33_BIDI
ad(31)	AA3 / 5	PCI33_BIDI
ad(32)	AA21 / 4	PCI33_BIDI
ad(33)	AB20 / 4	PCI33_BIDI
ad(34)	AA20 / 4	PCI33_BIDI
ad(35)	Y20 / 4	PCI33_BIDI
ad(36)	AB19 / 4	PCI33_BIDI
ad(37)	AA19 / 4	PCI33_BIDI
ad(38)	Y19 / 4	PCI33_BIDI
ad(39)	W19 / 4	PCI33_BIDI
ad(40)	AB18 / 4	PCI33_BIDI
ad(41)	AA18 / 4	PCI33_BIDI
ad(42)	Y18 / 4	PCI33_BIDI
ad(43)	W18 / 4	PCI33_BIDI
ad(44)	V18 / 4	PCI33_BIDI
ad(45)	U18 / 4	PCI33_BIDI
ad(46)	AB17 / 4	PCI33_BIDI
ad(47)	AA17 / 4	PCI33_BIDI
ad(48)	Y17 / 4	PCI33_BIDI
ad(49)	W17 / 4	PCI33_BIDI
ad(50)	V17 / 4	PCI33_BIDI
ad(51)	U17 / 4	PCI33_BIDI
ad(52)	AB16 / 4	PCI33_BIDI
ad(53)	AA16 / 4	PCI33_BIDI
ad(54)	Y16 / 4	PCI33_BIDI
ad(55)	W16 / 4	PCI33_BIDI
ad(56)	V16 / 4	PCI33_BIDI
ad(57)	U16 / 4	PCI33_BIDI
ad(58)	AB15 / 4	PCI33_BIDI
ad(59)	AA15 / 4	PCI33_BIDI
ad(60)	Y15 / 4	PCI33_BIDI
ad(61)	W15 / 4	PCI33_BIDI
ad(62)	V15 / 4	PCI33_BIDI
ad(63)	U15 / 4	PCI33_BIDI
cben(0)	AB12 / 5	PCI33_BIDI
cben(1)	AA10 / 5	PCI33_BIDI
cben(2)	V8 / 5	PCI33_BIDI
cben(3)	AB7 / 5	PCI33_BIDI
cben(4)	AA14 / 4	PCI33_BIDI

Table B-7. PCI Pin Assignments (Continued)

Signal Name	Pin/Bank	Buffer Type
cben(5)	Y14 / 4	PCI33_BIDI
cben(6)	W14 / 4	PCI33_BIDI
cben(7)	V14 / 4	PCI33_BIDI
par	AB10 / 5	PCI33_BIDI
par64	AB14 / 4	PCI33_BIDI
PCI Interface Controls		
Framen	U8 / 5	PCI33_BIDI
irdyn	AB9 / 5	PCI33_BIDI
trdyn	AA9 / 5	PCI33_BIDI
stopn	W9 / 5	PCI33_BIDI
idsel	AA7 / 5	PCI33_IN
devseln	Y9 / 5	PCI33_BIDI
perrn	V9 / 5	PCI33_BIDI
serrn	U9 / 5	PCI33_BIDI
ack64n	V13 / 4	PCI33_BIDI
req64n	U14 / 4	PCI33_BIDI
PCI Interrupts		
intan	W6 / 5	PCI33_OUT

Pin Assignment Considerations for MachXO Devices

PCI Pin Assignments for Target 33MHz 32-Bit Bus

The PCI Target 33MHz 32-bit core is optimized for LCMXO1200C-4FT256C. An example pin assignment, optimized for best performance, is given in [Table B-8](#). Refer to the readme file included with the core package for further information.

Table B-8. PCI Pin Assignments

Signal Name	Pin/Bank	Buffer Type
PCI System Pins		
clk	M5 / 6	LVC MOS33_IN
rstn	G2 / 7	LVC MOS33_IN
PCI Address and Data		
ad(0)	B9 / 1	PCI33_BIDI
ad(1)	D10 / 1	PCI33_BIDI
ad(2)	D9 / 1	PCI33_BIDI
ad(3)	C10 / 1	PCI33_BIDI
ad(4)	C9 / 1	PCI33_BIDI
ad(5)	A9 / 1	PCI33_BIDI
ad(6)	A10 / 1	PCI33_BIDI
ad(7)	E9 / 1	PCI33_BIDI
ad(8)	D7 / 0	PCI33_BIDI
ad(9)	D8 / 0	PCI33_BIDI
ad(10)	C8 / 0	PCI33_BIDI
ad(11)	B8 / 0	PCI33_BIDI

Table B-8. PCI Pin Assignments (Continued)

Signal Name	Pin/Bank	Buffer Type
ad(12)	A7 / 0	PCI33_BIDI
ad(13)	A6 / 0	PCI33_BIDI
ad(14)	B7 / 0	PCI33_BIDI
ad(15)	B6 / 0	PCI33_BIDI
ad(16)	C6 / 0	PCI33_BIDI
ad(17)	A4 / 0	PCI33_BIDI
ad(18)	A5 / 0	PCI33_BIDI
ad(19)	E6 / 0	PCI33_BIDI
ad(20)	E7 / 0	PCI33_BIDI
ad(21)	C5 / 0	PCI33_BIDI
ad(22)	C4 / 0	PCI33_BIDI
ad(23)	B5 / 0	PCI33_BIDI
ad(24)	D5 / 0	PCI33_BIDI
ad(25)	D6 / 0	PCI33_BIDI
ad(26)	A3 / 0	PCI33_BIDI
ad(27)	A2 / 0	PCI33_BIDI
ad(28)	D4 / 0	PCI33_BIDI
ad(29)	D3 / 0	PCI33_BIDI
ad(30)	B3 / 0	PCI33_BIDI
ad(31)	B2 / 0	PCI33_BIDI
cben(0)	A11 / 1	PCI33_BIDI
cben(1)	E8 / 1	PCI33_BIDI
cben(2)	C7 / 0	PCI33_BIDI
cben(3)	B4 / 0	PCI33_BIDI
par	D11 / 1	PCI33_BIDI
PCI Interface Controls		
Framen	B11 / 1	PCI33_BIDI
irdyn	B12 / 1	PCI33_BIDI
trdyn	C12 / 1	PCI33_BIDI
stopn	C11 / 1	PCI33_BIDI
idsel	A13 / 1	PCI33_IN
devseln	A12 / 1	PCI33_BIDI
perrn	E10 / 1	PCI33_BIDI
serrn	D12 / 1	PCI33_BIDI
PCI Interrupts		
intan	A14 / 1	PCI33_OUT

PCI Pin Assignments for Target 66MHz 32-Bit Bus

The PCI Target 66MHz 32-bit core is optimized for LCMXO1200C-4FT256C. An example pin assignment, optimized for best performance, is given in [Table B-9](#). Refer to the readme file included with the core package for further information.

Table B-9. PCI Pin Assignments

Signal Name	Pin/Bank	Buffer Type
PCI System Pins		
clk	M5 / 6	LVC MOS33_IN
rstn	G2 / 7	LVC MOS33_IN
PCI Address and Data		
ad(0)	A3 / 0	PCI33_BIDI
ad(1)	D6 / 0	PCI33_BIDI
ad(2)	D5 / 0	PCI33_BIDI
ad(3)	B4 / 0	PCI33_BIDI
ad(4)	B5 / 0	PCI33_BIDI
ad(5)	C4 / 0	PCI33_BIDI
ad(6)	C5 / 0	PCI33_BIDI
ad(7)	E7 / 0	PCI33_BIDI
ad(8)	E6 / 0	PCI33_BIDI
ad(9)	A5 / 0	PCI33_BIDI
ad(10)	A4 / 0	PCI33_BIDI
ad(11)	C6 / 0	PCI33_BIDI
ad(12)	C7 / 0	PCI33_BIDI
ad(13)	B6 / 0	PCI33_BIDI
ad(14)	B7 / 0	PCI33_BIDI
ad(15)	A6 / 0	PCI33_BIDI
ad(16)	E9 / 1	PCI33_BIDI
ad(17)	E8 / 1	PCI33_BIDI
ad(18)	A9 / 1	PCI33_BIDI
ad(19)	A10 / 1	PCI33_BIDI
ad(20)	C10 / 1	PCI33_BIDI
ad(21)	C9 / 1	PCI33_BIDI
ad(22)	D10 / 1	PCI33_BIDI
ad(23)	D9 / 1	PCI33_BIDI
ad(24)	B10 / 1	PCI33_BIDI
ad(25)	B9 / 1	PCI33_BIDI
ad(26)	A12 / 1	PCI33_BIDI
ad(27)	A11 / 1	PCI33_BIDI
ad(28)	B12 / 1	PCI33_BIDI
ad(29)	B11 / 1	PCI33_BIDI
ad(30)	C12 / 1	PCI33_BIDI
ad(31)	C11 / 1	PCI33_BIDI
cben(0)	A14 / 1	PCI33_BIDI

Table B-9. PCI Pin Assignments (Continued)

Signal Name	Pin/Bank	Buffer Type
cben(1)	E10 / 1	PCI33_BIDI
cben(2)	D12 / 1	PCI33_BIDI
cben(3)	B13 / 1	PCI33_BIDI
par	D11 / 1	PCI33_BIDI
PCI Interface Controls		
Framen	D7 / 0	PCI33_BIDI
irdyn	C8 / 0	PCI33_BIDI
trdyn	A7 / 0	PCI33_BIDI
stopn	B8 / 0	PCI33_BIDI
idsel	C14 / 1	PCI33_IN
devseln	D8 / 0	PCI33_BIDI
perrn	B14 / 1	PCI33_BIDI
serrn	E11 / 1	PCI33_BIDI
PCI Interrupts		
intan	A15 / 1	PCI33_OUT

PCI Pin Assignments for Master/Target 33MHz 32-Bit Bus

The PCI Master/Target 33MHz 32-bit core is optimized for LCMXO2280C-5FT324C. An example pin assignment, optimized for best performance, is given in [Table B-10](#). Refer to the readme file included with the core package for further information.

Table B-10. PCI Pin Assignments

Signal Name	Pin/Bank	Buffer Type
PCI System Pins		
clk	R3 / 6	LVC MOS33_IN
PCI Address and Data		
ad(0)	B5 / 0	PCI33_BIDI
ad(1)	C6 / 0	PCI33_BIDI
ad(2)	A5 / 0	PCI33_BIDI
ad(3)	E7 / 0	PCI33_BIDI
ad(4)	D7 / 0	PCI33_BIDI
ad(5)	E8 / 0	PCI33_BIDI
ad(6)	C7 / 0	PCI33_BIDI
ad(7)	F8 / 0	PCI33_BIDI
ad(8)	D8 / 0	PCI33_BIDI
ad(9)	B6 / 0	PCI33_BIDI
ad(10)	A6 / 0	PCI33_BIDI
ad(11)	B7 / 0	PCI33_BIDI
ad(12)	A7 / 0	PCI33_BIDI
ad(13)	C8 / 0	PCI33_BIDI
ad(14)	B8 / 0	PCI33_BIDI
ad(15)	A8 / 0	PCI33_BIDI
ad(16)	D9 / 1	PCI33_BIDI

Table B-10. PCI Pin Assignments (Continued)

Signal Name	Pin/Bank	Buffer Type
ad(17)	E9 / 1	PCI33_BIDI
ad(18)	E10 / 1	PCI33_BIDI
ad(19)	C10 / 1	PCI33_BIDI
ad(20)	B11 / 1	PCI33_BIDI
ad(21)	A11 / 1	PCI33_BIDI
ad(22)	F10 / 1	PCI33_BIDI
ad(23)	D10 / 1	PCI33_BIDI
ad(24)	C11 / 1	PCI33_BIDI
ad(25)	A12 / 1	PCI33_BIDI
ad(26)	E11 / 1	PCI33_BIDI
ad(27)	D11 / 1	PCI33_BIDI
ad(28)	C12 / 1	PCI33_BIDI
ad(29)	B12 / 1	PCI33_BIDI
ad(30)	B13 / 1	PCI33_BIDI
ad(31)	A13 / 1	PCI33_BIDI
cben(0)	D12 / 1	PCI33_BIDI
cben(1)	A15 / 1	PCI33_BIDI
cben(2)	B14 / 1	PCI33_BIDI
cben(3)	B16 / 1	PCI33_BIDI
par	A14 / 1	PCI33_BIDI
PCI Interface Controls		
Framen	B10 / 0	PCI33_BIDI
irdyn	A9 / 0	PCI33_BIDI
trdyn	B9 / 0	PCI33_BIDI
stopn	C9 / 0	PCI33_BIDI
idsel	C14 / 1	PCI33_IN
devseln	A10 / 0	PCI33_BIDI
perrn	E12 / 1	PCI33_BIDI
serrn	B15 / 1	PCI33_BIDI
PCI Interrupts		
intan	F12 / 1	PCI33_OUT
PCI Bus Arbitration		
gntn	F11 / 1	PCI33_IN
reqn	C13 / 1	PCI33_OUT

PCI Assignment Considerations for LatticeSC Devices

PCI Pin Assignments for Master/Target 33 MHz 32-bit Bus

The PCI Master/Target 33 MHz 32-bit core is optimized for LFSC3GA25E-5F900C. An example pin assignment, optimized for best performance, is given in [Table B-11](#). Refer to the readme file included with the core package for further information.

Table B-11. PCI Pin Assignments

Signal Name	Pin/Bank	I/O Type
PCI System Pins		
clk	AH1/5	PCI33_IN
rstn	AJ11/4	PCI33_IN
PCI Address and Data		
ad[0]	AJ8/5	PCI33_BIDI
ad[1]	AJ7/5	PCI33_BIDI
ad[2]	AJ6/5	PCI33_BIDI
ad[3]	AJ5/5	PCI33_BIDI
ad[4]	AK5/5	PCI33_BIDI
ad[5]	AK4/5	PCI33_BIDI
ad[6]	AE13/5	PCI33_BIDI
ad[7]	AE12/5	PCI33_BIDI
ad[8]	AH8/5	PCI33_BIDI
ad[9]	AH7/5	PCI33_BIDI
ad[10]	AF10/5	PCI33_BIDI
ad[11]	AE11/5	PCI33_BIDI
ad[12]	AJ4/5	PCI33_BIDI
ad[13]	AK3/5	PCI33_BIDI
ad[14]	AE10/5	PCI33_BIDI
ad[15]	AF9/5	PCI33_BIDI
ad[16]	AJ3/5	PCI33_BIDI
ad[17]	AH3/5	PCI33_BIDI
ad[18]	AG8/5	PCI33_BIDI
ad[19]	AF8/5	PCI33_BIDI
ad[20]	AG5/5	PCI33_BIDI
ad[21]	AH4/5	PCI33_BIDI
ad[22]	AF6/5	PCI33_BIDI
ad[23]	AF7/5	PCI33_BIDI
ad[24]	AD8/5	PCI33_BIDI
ad[25]	AD7/5	PCI33_BIDI
ad[26]	AK2/5	PCI33_BIDI
ad[27]	AJ2/5	PCI33_BIDI
ad[28]	AD6/5	PCI33_BIDI
ad[29]	AH2/5	PCI33_BIDI
ad[30]	AG3/5	PCI33_BIDI
ad[31]	AE5/5	PCI33_BIDI
cben[0]	AH10/5	PCI33_BIDI
cben[1]	AH11/5	PCI33_BIDI

Table B-11. PCI Pin Assignments (Continued)

Signal Name	Pin/Bank	I/O Type
cben[2]	AF13/5	PCI33_BIDI
cben[3]	AE14/5	PCI33_BIDI
par	AG14/5	PCI33_BIDI
PCI Interface Controls		
framen	AF15/5	PCI33_BIDI
irdyn	AK7/5	PCI33_BIDI
trdyn	AK6/5	PCI33_BIDI
stopn	AH13/5	PCI33_BIDI
idsel	AG13/5	PCI33_IN
devseln	AK8/5	PCI33_BIDI
perrn	AK9/5	PCI33_BIDI
serrn	AH14/5	PCI33_BIDI
PCI Interrupts		
intan	AJ12/5	PCI33_OUT
PCI Bus Arbitration		
gntn	AF4/5	PCI33_IN
reqn	AJ1/5	PCI33_OUT

PCI Pin Assignments for Master/Target 33 MHz 64-bit Bus

The PCI Master/Target 33 MHz 64-bit core is optimized for LFSC3GA25E-5F900C. An example pin assignment, optimized for best performance, is given in [Table B-12](#). Refer to the readme file included with the core package for further information.

Table B-12. PCI Pin Assignments

Signal Name	Pin/Bank	I/O Type
PCI System Pins		
clk	AH1/5	PCI33_IN
rstn	AJ11/5	PCI33_IN
PCI Address and Data		
ad[0]	AJ8/5	PCI33_BIDI
ad[1]	AJ7/5	PCI33_BIDI
ad[2]	AJ6/5	PCI33_BIDI
ad[3]	AJ5/5	PCI33_BIDI
ad[4]	AK5/5	PCI33_BIDI
ad[5]	AK4/5	PCI33_BIDI
ad[6]	AE13/5	PCI33_BIDI
ad[7]	AE12/5	PCI33_BIDI
ad[8]	AH8/5	PCI33_BIDI
ad[9]	AH7/5	PCI33_BIDI
ad[10]	AF10/5	PCI33_BIDI
ad[11]	AE11/5	PCI33_BIDI
ad[12]	AJ4/5	PCI33_BIDI
ad[13]	AK3/5	PCI33_BIDI

Table B-12. PCI Pin Assignments (Continued)

Signal Name	Pin/Bank	I/O Type
ad[14]	AE10/5	PCI33_BIDI
ad[15]	AF9/5	PCI33_BIDI
ad[16]	AJ3/5	PCI33_BIDI
ad[17]	AH3/5	PCI33_BIDI
ad[18]	AG8/5	PCI33_BIDI
ad[19]	AF8/5	PCI33_BIDI
ad[20]	AG5/5	PCI33_BIDI
ad[21]	AH4/5	PCI33_BIDI
ad[22]	AF6/5	PCI33_BIDI
ad[23]	AF7/5	PCI33_BIDI
ad[24]	AD8/5	PCI33_BIDI
ad[25]	AD7/5	PCI33_BIDI
ad[26]	AK2/5	PCI33_BIDI
ad[27]	AJ2/5	PCI33_BIDI
ad[28]	AD6/5	PCI33_BIDI
ad[29]	AH2/5	PCI33_BIDI
ad[30]	AG3/5	PCI33_BIDI
ad[31]	AE5/5	PCI33_BIDI
ad[32]	AK23/4	PCI33_BIDI
ad[33]	AK22/4	PCI33_BIDI
ad[34]	AF19/4	PCI33_BIDI
ad[35]	AG19/4	PCI33_BIDI
ad[36]	AJ21/4	PCI33_BIDI
ad[37]	AJ20/4	PCI33_BIDI
ad[38]	AG18/4	PCI33_BIDI
ad[39]	AF18/4	PCI33_BIDI
ad[40]	AK20/4	PCI33_BIDI
ad[41]	AJ19/4	PCI33_BIDI
ad[42]	AJ18/4	PCI33_BIDI
ad[43]	AG17/4	PCI33_BIDI
ad[44]	AF17/4	PCI33_BIDI
ad[45]	AH18/4	PCI33_BIDI
ad[46]	AH17/4	PCI33_BIDI
ad[47]	AK19/4	PCI33_BIDI
ad[48]	AK18/4	PCI33_BIDI
ad[49]	AG16/4	PCI33_BIDI
ad[50]	AH16/4	PCI33_BIDI
ad[51]	AF16/4	PCI33_BIDI
ad[52]	AE16/4	PCI33_BIDI
ad[53]	AJ17/4	PCI33_BIDI
ad[54]	AJ16/4	PCI33_BIDI

Table B-12. PCI Pin Assignments (Continued)

Signal Name	Pin/Bank	I/O Type
ad[55]	AK17/4	PCI33_BIDI
ad[56]	AK16/4	PCI33_BIDI
ad[57]	AK15/5	PCI33_BIDI
ad[58]	AK14/5	PCI33_BIDI
ad[59]	AJ15/5	PCI33_BIDI
ad[60]	AJ14/5	PCI33_BIDI
ad[61]	AK13/5	PCI33_BIDI
ad[62]	AK12/5	PCI33_BIDI
ad[63]	AE15/5	PCI33_BIDI
cben[0]	AH10/5	PCI33_BIDI
cben[1]	AH11/5	PCI33_BIDI
cben[2]	AF13/5	PCI33_BIDI
cben[3]	AE14/5	PCI33_BIDI
cben[4]	AG15/5	PCI33_BIDI
cben[5]	AH12/5	PCI33_BIDI
cben[6]	AJ13/5	PCI33_BIDI
cben[7]	AD15/5	PCI33_BIDI
par	AG14/5	PCI33_BIDI
par64	AK10/5	PCI33_BIDI
PCI Interface Controls		
framen	AF15/5	PCI33_BIDI
irdyn	AK7/5	PCI33_BIDI
trdyn	AK6/5	PCI33_BIDI
stopn	AH13/5	PCI33_BIDI
idsel	AG13/5	PCI33_IN
devseln	AK8/5	PCI33_BIDI
perrn	AK9/5	PCI33_BIDI
serrn	AH14/5	PCI33_BIDI
ack64n	AH15/5	PCI33_BIDI
req64n	K11/5	PCI33_BIDI
PCI Interrupts		
intan	AJ12/5	PCI33_OUT
PCI Bus Arbitration		
gntn	AF4/5	PCI33_IN
reqn	AJ1/5	PCI33_OUT

PCI Pin Assignments for Target 33 MHz 32-bit Bus

The PCI Target 33 MHz 32-bit core is optimized for LFSC3GA25E-5F900C. An example pin assignment, optimized for best performance, is given in [Table B-13](#). Refer to the readme file included with the core package for further information.

Table B-13. PCI Pin Assignments

Signal Name	Pin/Bank	I/O Type
PCI System Pins		
clk	AH1/5	PCI33_IN
rstn	AJ11/4	PCI33_IN
PCI Address and Data		
ad[0]	AJ8/5	PCI33_BIDI
ad[1]	AJ7/5	PCI33_BIDI
ad[2]	AJ6/5	PCI33_BIDI
ad[3]	AJ5/5	PCI33_BIDI
ad[4]	AK5/5	PCI33_BIDI
ad[5]	AK4/5	PCI33_BIDI
ad[6]	AE13/5	PCI33_BIDI
ad[7]	AE12/5	PCI33_BIDI
ad[8]	AH8/5	PCI33_BIDI
ad[9]	AH7/5	PCI33_BIDI
ad[10]	AF10/5	PCI33_BIDI
ad[11]	AE11/5	PCI33_BIDI
ad[12]	AJ4/5	PCI33_BIDI
ad[13]	AK3/5	PCI33_BIDI
ad[14]	AE10/5	PCI33_BIDI
ad[15]	AF9/5	PCI33_BIDI
ad[16]	AJ3/5	PCI33_BIDI
ad[17]	AH3/5	PCI33_BIDI
ad[18]	AG8/5	PCI33_BIDI
ad[19]	AF8/5	PCI33_BIDI
ad[20]	AG5/5	PCI33_BIDI
ad[21]	AH4/5	PCI33_BIDI
ad[22]	AF6/5	PCI33_BIDI
ad[23]	AF7/5	PCI33_BIDI
ad[24]	AD8/5	PCI33_BIDI
ad[25]	AD7/5	PCI33_BIDI
ad[26]	AK2/5	PCI33_BIDI
ad[27]	AJ2/5	PCI33_BIDI
ad[28]	AD6/5	PCI33_BIDI
ad[29]	AH2/5	PCI33_BIDI
ad[30]	AG3/5	PCI33_BIDI
ad[31]	AE5/5	PCI33_BIDI
cben[0]	AH10/5	PCI33_IN
cben[1]	AH11/5	PCI33_IN
cben[2]	AF13/5	PCI33_IN

Table B-13. PCI Pin Assignments (Continued)

Signal Name	Pin/Bank	I/O Type
cben[3]	AE14/5	PCI33_IN
par	AG14/5	PCI33_BIDI
PCI Interface Controls		
framen	AF15/5	PCI33_IN
irdyn	AK7/5	PCI33_IN
trdyn	AK6/5	PCI33_OUT
stopn	AH13/5	PCI33_OUT
idsel	AG13/5	PCI33_IN
devseln	AK8/5	PCI33_OUT
perrn	AK9/5	PCI33_OUT
serrn	AH14/5	PCI33_OUT
PCI Interrupts		
intan	AJ12/5	PCI33_OUT

PCI Pin Assignments for Target 33 MHz 64-bit Bus

The PCI Target 33 MHz 64-bit core is optimized for LFSC3GA25E-5F900C. An example pin assignment, optimized for best performance, is given in [Table B-14](#). Refer to the readme file included with the core package for further information.

Table B-14. PCI Pin Assignments

Signal Name	Pin/Bank	I/O Type
PCI System Pins		
clk	AH1/5	PCI33_IN
rstn	AJ11/5	PCI33_IN
PCI Address and Data		
ad[0]	AJ8/5	PCI33_BIDI
ad[1]	AJ7/5	PCI33_BIDI
ad[2]	AJ6/5	PCI33_BIDI
ad[3]	AJ5/5	PCI33_BIDI
ad[4]	AK5/5	PCI33_BIDI
ad[5]	AK4/5	PCI33_BIDI
ad[6]	AE13/5	PCI33_BIDI
ad[7]	AE12/5	PCI33_BIDI
ad[8]	AH8/5	PCI33_BIDI
ad[9]	AH7/5	PCI33_BIDI
ad[10]	AF10/5	PCI33_BIDI
ad[11]	AE11/5	PCI33_BIDI
ad[12]	AJ4/5	PCI33_BIDI
ad[13]	AK3/5	PCI33_BIDI
ad[14]	AE10/5	PCI33_BIDI
ad[15]	AF9/5	PCI33_BIDI
ad[16]	AJ3/5	PCI33_BIDI
ad[17]	AH3/5	PCI33_BIDI
ad[18]	AG8/5	PCI33_BIDI
ad[19]	AF8/5	PCI33_BIDI

Table B-14. PCI Pin Assignments (Continued)

Signal Name	Pin/Bank	I/O Type
ad[20]	AG5/5	PCI33_BIDI
ad[21]	AH4/5	PCI33_BIDI
ad[22]	AF6/5	PCI33_BIDI
ad[23]	AF7/5	PCI33_BIDI
ad[24]	AD8/5	PCI33_BIDI
ad[25]	AD7/5	PCI33_BIDI
ad[26]	AK2/5	PCI33_BIDI
ad[27]	AJ2/5	PCI33_BIDI
ad[28]	AD6/5	PCI33_BIDI
ad[29]	AH2/5	PCI33_BIDI
ad[30]	AG3/5	PCI33_BIDI
ad[31]	AE5/5	PCI33_BIDI
ad[32]	AK23/4	PCI33_BIDI
ad[33]	AK22/4	PCI33_BIDI
ad[34]	AF19/4	PCI33_BIDI
ad[35]	AG19/4	PCI33_BIDI
ad[36]	AJ21/4	PCI33_BIDI
ad[37]	AJ20/4	PCI33_BIDI
ad[38]	AG18/4	PCI33_BIDI
ad[39]	AF18/4	PCI33_BIDI
ad[40]	AK20/4	PCI33_BIDI
ad[41]	AJ19/4	PCI33_BIDI
ad[42]	AJ18/4	PCI33_BIDI
ad[43]	AG17/4	PCI33_BIDI
ad[44]	AF17/4	PCI33_BIDI
ad[45]	AH18/4	PCI33_BIDI
ad[46]	AH17/4	PCI33_BIDI
ad[47]	AK19/4	PCI33_BIDI
ad[48]	AK18/4	PCI33_BIDI
ad[49]	AG16/4	PCI33_BIDI
ad[50]	AH16/4	PCI33_BIDI
ad[51]	AF16/4	PCI33_BIDI
ad[52]	AE16/4	PCI33_BIDI
ad[53]	AJ17/4	PCI33_BIDI
ad[54]	AJ16/4	PCI33_BIDI
ad[55]	AK17/4	PCI33_BIDI
ad[56]	AK16/4	PCI33_BIDI
ad[57]	AK15/5	PCI33_BIDI
ad[58]	AK14/5	PCI33_BIDI
ad[59]	AJ15/5	PCI33_BIDI
ad[60]	AJ14/5	PCI33_BIDI
ad[61]	AK13/5	PCI33_BIDI
ad[62]	AK12/5	PCI33_BIDI
ad[63]	AE15/5	PCI33_BIDI

Table B-14. PCI Pin Assignments (Continued)

Signal Name	Pin/Bank	I/O Type
cben[0]	AH10/5	PCI33_IN
cben[1]	AH11/5	PCI33_IN
cben[2]	AF13/5	PCI33_IN
cben[3]	AE14/5	PCI33_IN
cben[4]	AG15/5	PCI33_IN
cben[5]	AH12/5	PCI33_IN
cben[6]	AJ13/5	PCI33_IN
cben[7]	AD15/5	PCI33_IN
par	AG14/5	PCI33_BIDI
par64	AK10/5	PCI33_BIDI
PCI Interface Controls		
framen	AF15/5	PCI33_IN
irdyn	AK7/5	PCI33_IN
trdyn	AK6/5	PCI33_OUT
stopn	AH13	PCI33_OUT
idsel	AG13/5	PCI33_IN
devseln	AK8/5	PCI33_OUT
perrn	AK9/5	PCI33_OUT
serrn	AH14/5	PCI33_OUT
ack64n	AH15/5	PCI33_OUT
req64n	K11/5	PCI33_IN
PCI Interrupts		
intan	AJ12/5	PCI33_OUT

PCI Pin Assignments for Master/Target 66 MHz 32-bit Bus

The PCI Master/Target 66 MHz 32-bit core is optimized for LFSC3GA25E-5F900C. An example pin assignment, optimized for best performance, is given in [Table B-15](#). Refer to the readme file included with the core package for further information.

Table B-15. PCI Pin Assignments

Signal Name	Pin/Bank	I/O Type
PCI System Pins		
clk	AH1/5	PCI33_IN
rstn	AJ11/5	PCI33_IN
PCI Address and Data		
ad[0]	AJ8/5	PCI33_BIDI
ad[1]	AJ7/5	PCI33_BIDI
ad[2]	AJ6/5	PCI33_BIDI
ad[3]	AJ5/5	PCI33_BIDI
ad[4]	AK5/5	PCI33_BIDI
ad[5]	AK4/5	PCI33_BIDI
ad[6]	AE13/5	PCI33_BIDI
ad[7]	AE12/5	PCI33_BIDI
ad[8]	AH8/5	PCI33_BIDI
ad[9]	AH7/5	PCI33_BIDI

Table B-15. PCI Pin Assignments (Continued)

Signal Name	Pin/Bank	I/O Type
ad[10]	AF10/5	PCI33_BIDI
ad[11]	AE11/5	PCI33_BIDI
ad[12]	AJ4/5	PCI33_BIDI
ad[13]	AK3/5	PCI33_BIDI
ad[14]	AE10/5	PCI33_BIDI
ad[15]	AF9/5	PCI33_BIDI
ad[16]	AJ3/5	PCI33_BIDI
ad[17]	AH3/5	PCI33_BIDI
ad[18]	AG8/5	PCI33_BIDI
ad[19]	AF8/5	PCI33_BIDI
ad[20]	AG5/5	PCI33_BIDI
ad[21]	AH4/5	PCI33_BIDI
ad[22]	AF6/5	PCI33_BIDI
ad[23]	AF7/5	PCI33_BIDI
ad[24]	AD8/5	PCI33_BIDI
ad[25]	AD7/5	PCI33_BIDI
ad[26]	AK2/5	PCI33_BIDI
ad[27]	AJ2/5	PCI33_BIDI
ad[28]	AD6/5	PCI33_BIDI
ad[29]	AH2/5	PCI33_BIDI
ad[30]	AG3/5	PCI33_BIDI
ad[31]	AE5/5	PCI33_BIDI
cben[0]	AH10/5	PCI33_BIDI
cben[1]	AH11/5	PCI33_BIDI
cben[2]	AF13/5	PCI33_BIDI
cben[3]	AE14/5	PCI33_BIDI
par	AG14/5	PCI33_BIDI
PCI Interface Controls		
framen	AF15/5	PCI33_BIDI
irdyn	AK7/5	PCI33_BIDI
trdyn	AK6/5	PCI33_BIDI
stopn	AH13/5	PCI33_BIDI
idsel	AG13/5	PCI33_IN
devseln	AK8/5	PCI33_BIDI
perrn	AK9/5	PCI33_BIDI
serrn	AH14/5	PCI33_BIDI
PCI Interrupts		
intan	AJ12/5	PCI33_OUT
PCI Bus Arbitration		
reqn	AJ1/5	PCI33_IN
gntn	AF4/5	PCI33_OUT

PCI Pin Assignments for Master/Target 66 MHz 64-bit Bus

The PCI Master/Target 66 MHz 64-bit core is optimized for LFSC3GA25E-5F900C. An example pin assignment, optimized for best performance, is given in [Table B-16](#). Refer to the readme file included with the core package for further information.

Table B-16. PCI Pin Assignments

Signal Name	Pin/Bank	I/O Type
PCI System Pins		
clk	AH1/5	PCI33_IN
rstn	AJ11/5	PCI33_IN
PCI Address and Data		
ad[0]	AJ8/5	PCI33_BIDI
ad[1]	AJ7/5	PCI33_BIDI
ad[2]	AJ6/5	PCI33_BIDI
ad[3]	AJ5/5	PCI33_BIDI
ad[4]	AK5/5	PCI33_BIDI
ad[5]	AK4/5	PCI33_BIDI
ad[6]	AE13/5	PCI33_BIDI
ad[7]	AE12/5	PCI33_BIDI
ad[8]	AH8/5	PCI33_BIDI
ad[9]	AH7/5	PCI33_BIDI
ad[10]	AF10/5	PCI33_BIDI
ad[11]	AE11/5	PCI33_BIDI
ad[12]	AJ4/5	PCI33_BIDI
ad[13]	AK3/5	PCI33_BIDI
ad[14]	AE10/5	PCI33_BIDI
ad[15]	AF9/5	PCI33_BIDI
ad[16]	AJ3/5	PCI33_BIDI
ad[17]	AH3/5	PCI33_BIDI
ad[18]	AG8/5	PCI33_BIDI
ad[19]	AF8/5	PCI33_BIDI
ad[20]	AG5/5	PCI33_BIDI
ad[21]	AH4/5	PCI33_BIDI
ad[22]	AF6/5	PCI33_BIDI
ad[23]	AF7/5	PCI33_BIDI
ad[24]	AD8/5	PCI33_BIDI
ad[25]	AD7/5	PCI33_BIDI
ad[26]	AK2/5	PCI33_BIDI
ad[27]	AJ2/5	PCI33_BIDI
ad[28]	AD6/5	PCI33_BIDI
ad[29]	AH2/5	PCI33_BIDI
ad[30]	AG3/5	PCI33_BIDI
ad[31]	AE5/5	PCI33_BIDI
ad[32]	AK23/4	PCI33_BIDI
ad[33]	AK22/4	PCI33_BIDI
ad[34]	AF19/4	PCI33_BIDI

Table B-16. PCI Pin Assignments (Continued)

Signal Name	Pin/Bank	I/O Type
ad[35]	AG19/4	PCI33_BIDI
ad[36]	AJ21/4	PCI33_BIDI
ad[37]	AJ20/4	PCI33_BIDI
ad[38]	AG18/4	PCI33_BIDI
ad[39]	AF18/4	PCI33_BIDI
ad[40]	AK20/4	PCI33_BIDI
ad[41]	AJ19/4	PCI33_BIDI
ad[42]	AJ18/4	PCI33_BIDI
ad[43]	AG17/4	PCI33_BIDI
ad[44]	AF17/4	PCI33_BIDI
ad[45]	AH18/4	PCI33_BIDI
ad[46]	AH17/4	PCI33_BIDI
ad[47]	AK19/4	PCI33_BIDI
ad[48]	AK18/4	PCI33_BIDI
ad[49]	AG16/4	PCI33_BIDI
ad[50]	AH16/4	PCI33_BIDI
ad[51]	AF16/4	PCI33_BIDI
ad[52]	AE16/4	PCI33_BIDI
ad[53]	AJ17/4	PCI33_BIDI
ad[54]	AJ16/4	PCI33_BIDI
ad[55]	AK17/4	PCI33_BIDI
ad[56]	AK16/4	PCI33_BIDI
ad[57]	AK15/5	PCI33_BIDI
ad[58]	AK14/5	PCI33_BIDI
ad[59]	AJ15/5	PCI33_BIDI
ad[60]	AJ14/5	PCI33_BIDI
ad[61]	AK13/5	PCI33_BIDI
ad[62]	AK12/5	PCI33_BIDI
ad[63]	AE15/5	PCI33_BIDI
cben[0]	AH10/5	PCI33_BIDI
cben[1]	AH11/5	PCI33_BIDI
cben[2]	AF13/5	PCI33_BIDI
cben[3]	AE14/5	PCI33_BIDI
cben[4]	AG15/5	PCI33_BIDI
cben[5]	AH12/5	PCI33_BIDI
cben[6]	AJ13/5	PCI33_BIDI
cben[7]	AD15/5	PCI33_BIDI
par64	AK10/5	PCI33_BIDI
par	AG14/5	PCI33_BIDI
PCI Interface Controls		
framen	AF15/5	PCI33_BIDI
irdyn	AK7/5	PCI33_BIDI
trdyn	AK6/5	PCI33_BIDI
stopn	AH13/5	PCI33_BIDI

Table B-16. PCI Pin Assignments (Continued)

Signal Name	Pin/Bank	I/O Type
idsel	AG13/5	PCI33_IN
devseln	AK8/5	PCI33_BIDI
perrn	AK9/5	PCI33_BIDI
serrn	AH14/5	PCI33_BIDI
ack64n	AH15/5	PCI33_BIDI
req64n	K11/5	PCI33_BIDI
PCI Interrupts		
intan	AJ12/5	PCI33_IN
PCI Bus Arbitration		
gntn	AF4/5	PCI33_IN
reqn	AJ1/5	PCI33_OUT

PCI Pin Assignments for Target 66 MHz 32-bit Bus

The PCI Target 66 MHz 32-bit core is optimized for LFSC3GA25E-5F900C. An example pin assignment, optimized for best performance, is given in [Table B-17](#). Refer to the readme file included with the core package for further information.

Table B-17. PCI Pin Assignments

Signal Name	Pin/Bank	I/O Type
PCI System Pins		
clk	AH1/5	PCI33_IN
rstn	AJ11/5	PCI33_IN
PCI Address and Data		
ad[0]	AJ8/5	PCI33_BIDI
ad[1]	AJ7/5	PCI33_BIDI
ad[2]	AJ6/5	PCI33_BIDI
ad[3]	AJ5/5	PCI33_BIDI
ad[4]	AK5/5	PCI33_BIDI
ad[5]	AK4/5	PCI33_BIDI
ad[6]	AE13/5	PCI33_BIDI
ad[7]	AE12/5	PCI33_BIDI
ad[8]	AH8/5	PCI33_BIDI
ad[9]	AH7/5	PCI33_BIDI
ad[10]	AF10/5	PCI33_BIDI
ad[11]	AE11/5	PCI33_BIDI
ad[12]	AJ4/5	PCI33_BIDI
ad[13]	AK3/5	PCI33_BIDI
ad[14]	AE10/5	PCI33_BIDI
ad[15]	AF9/5	PCI33_BIDI
ad[16]	AJ3/5	PCI33_BIDI
ad[17]	AH3/5	PCI33_BIDI
ad[18]	AG8/5	PCI33_BIDI
ad[19]	AF8/5	PCI33_BIDI
ad[20]	AG5/5	PCI33_BIDI
ad[21]	AH4/5	PCI33_BIDI

Table B-17. PCI Pin Assignments (Continued)

Signal Name	Pin/Bank	I/O Type
ad[22]	AF6/5	PCI33_BIDI
ad[23]	AF7/5	PCI33_BIDI
ad[24]	AD8/5	PCI33_BIDI
ad[25]	AD7/5	PCI33_BIDI
ad[26]	AK2/5	PCI33_BIDI
ad[27]	AJ2/5	PCI33_BIDI
ad[28]	AD6/5	PCI33_BIDI
ad[29]	AH2/5	PCI33_BIDI
ad[30]	AG3/5	PCI33_BIDI
ad[31]	AE5/5	PCI33_BIDI
ad[32]	AK23/4	PCI33_BIDI
ad[33]	AK22/4	PCI33_BIDI
ad[34]	AF19/4	PCI33_BIDI
ad[35]	AG19/4	PCI33_BIDI
ad[36]	AJ21/4	PCI33_BIDI
ad[37]	AJ20/4	PCI33_BIDI
ad[38]	AG18/4	PCI33_BIDI
ad[39]	AF18/4	PCI33_BIDI
ad[40]	AK20/4	PCI33_BIDI
ad[41]	AJ19/4	PCI33_BIDI
ad[42]	AJ18/4	PCI33_BIDI
ad[43]	AG17/4	PCI33_BIDI
ad[44]	AF17/4	PCI33_BIDI
ad[45]	AH18/4	PCI33_BIDI
ad[46]	AH17/4	PCI33_BIDI
ad[47]	AK19/4	PCI33_BIDI
ad[48]	AK18/4	PCI33_BIDI
ad[49]	AG16/4	PCI33_BIDI
ad[50]	AH16/4	PCI33_BIDI
ad[51]	AF16/4	PCI33_BIDI
ad[52]	AE16/4	PCI33_BIDI
ad[53]	AJ17/4	PCI33_BIDI
ad[54]	AJ16/4	PCI33_BIDI
ad[55]	AK17/4	PCI33_BIDI
ad[56]	AK16/4	PCI33_BIDI
ad[57]	AK15/5	PCI33_BIDI
ad[58]	AK14/5	PCI33_BIDI
ad[59]	AJ15/5	PCI33_BIDI
ad[60]	AJ14/5	PCI33_BIDI
ad[61]	AK13/5	PCI33_BIDI
ad[62]	AK12/5	PCI33_BIDI
ad[63]	AE15/5	PCI33_BIDI
cben[0]	AH10/5	PCI33_BIDI
cben[1]	AH11/5	PCI33_BIDI

Table B-17. PCI Pin Assignments (Continued)

Signal Name	Pin/Bank	I/O Type
cben[2]	AF13/5	PCI33_BIDI
cben[3]	AE14/5	PCI33_BIDI
cben[4]	AG15/5	PCI33_BIDI
cben[5]	AH12/5	PCI33_BIDI
cben[6]	AJ13/5	PCI33_BIDI
cben[7]	AD15/5	PCI33_BIDI
par64	AK10/5	PCI33_BIDI
par	AG14/5	PCI33_BIDI
PCI Interface Controls		
framen	AF15/5	PCI33_BIDI
irdyn	AK7/5	PCI33_BIDI
trdyn	AK6/5	PCI33_BIDI
stopn	AH13/5	PCI33_BIDI
idsel	AG13/5	PCI33_IN
devseln	AK8/5	PCI33_BIDI
perrn	AK9/5	PCI33_BIDI
serrn	AH14/5	PCI33_BIDI
ack64n	AH15/5	PCI33_BIDI
req64n	K11/5	PCI33_BIDI
PCI Interrupts		
intan	AJ12/5	PCI33_IN
PCI Bus Arbitration		
gntn	AF4/5	PCI33_IN
reqn	AJ1/5	PCI33_OUT

PCI Pin Assignments for Target 66 MHz 64-bit Bus

The PCI Target 66 MHz 64-bit core is optimized for LFSC3GA25E-5F900C. An example pin assignment, optimized for best performance, is given in [Table B-18](#). Refer to the readme file included with the core package for further information.

Table B-18. PCI Pin Assignments

Signal Name	Pin/Bank	I/O Type
PCI System Pins		
clk	AH1/5	PCI33_IN
rstn	AJ11/5	PCI33_IN
PCI Address and Data		
ad[0]	AJ8/5	PCI33_BIDI
ad[1]	AJ7/5	PCI33_BIDI
ad[2]	AJ6/5	PCI33_BIDI
ad[3]	AJ5/5	PCI33_BIDI
ad[4]	AK5/5	PCI33_BIDI
ad[5]	AK4/5	PCI33_BIDI
ad[6]	AE13/5	PCI33_BIDI
ad[7]	AE12/5	PCI33_BIDI
ad[8]	AH8/5	PCI33_BIDI

Table B-18. PCI Pin Assignments (Continued)

Signal Name	Pin/Bank	I/O Type
ad[9]	AH7/5	PCI33_BIDI
ad[10]	AF10/5	PCI33_BIDI
ad[11]	AE11/5	PCI33_BIDI
ad[12]	AJ4/5	PCI33_BIDI
ad[13]	AK3/5	PCI33_BIDI
ad[14]	AE10/5	PCI33_BIDI
ad[15]	AF9/5	PCI33_BIDI
ad[16]	AJ3/5	PCI33_BIDI
ad[17]	AH3/5	PCI33_BIDI
ad[18]	AG8/5	PCI33_BIDI
ad[19]	AF8/5	PCI33_BIDI
ad[20]	AG5/5	PCI33_BIDI
ad[21]	AH4/5	PCI33_BIDI
ad[22]	AF6/5	PCI33_BIDI
ad[23]	AF7/5	PCI33_BIDI
ad[24]	AD8/5	PCI33_BIDI
ad[25]	AD7/5	PCI33_BIDI
ad[26]	AK2/5	PCI33_BIDI
ad[27]	AJ2/5	PCI33_BIDI
ad[28]	AD6/5	PCI33_BIDI
ad[29]	AH2/5	PCI33_BIDI
ad[30]	AG3/5	PCI33_BIDI
ad[31]	AE5/5	PCI33_BIDI
ad[32]	AK23/4	PCI33_BIDI
ad[33]	AK22/4	PCI33_BIDI
ad[34]	AF19/4	PCI33_BIDI
ad[35]	AG19/4	PCI33_BIDI
ad[36]	AJ21/4	PCI33_BIDI
ad[37]	AJ20/4	PCI33_BIDI
ad[38]	AG18/4	PCI33_BIDI
ad[39]	AF18/4	PCI33_BIDI
ad[40]	AK20/4	PCI33_BIDI
ad[41]	AJ19/4	PCI33_BIDI
ad[42]	AJ18/4	PCI33_BIDI
ad[43]	AG17/4	PCI33_BIDI
ad[44]	AF17/4	PCI33_BIDI
ad[45]	AH18/4	PCI33_BIDI
ad[46]	AH17/4	PCI33_BIDI
ad[47]	AK19/4	PCI33_BIDI
ad[48]	AK18/4	PCI33_BIDI
ad[49]	AG16/4	PCI33_BIDI
ad[50]	AH16/4	PCI33_BIDI
ad[51]	AF16/4	PCI33_BIDI
ad[52]	AE16/4	PCI33_BIDI

Table B-18. PCI Pin Assignments (Continued)

Signal Name	Pin/Bank	I/O Type
ad[53]	AJ17/4	PCI33_BIDI
ad[54]	AJ16/4	PCI33_BIDI
ad[55]	AK17/4	PCI33_BIDI
ad[56]	AK16/4	PCI33_BIDI
ad[57]	AK15/5	PCI33_BIDI
ad[58]	AK14/5	PCI33_BIDI
ad[59]	AJ15/5	PCI33_BIDI
ad[60]	AJ14/5	PCI33_BIDI
ad[61]	AK13/5	PCI33_BIDI
ad[62]	AK12/5	PCI33_BIDI
ad[63]	AE15/5	PCI33_BIDI
cben[0]	AH10/5	PCI33_IN
cben[1]	AH11/5	PCI33_IN
cben[2]	AF13/5	PCI33_IN
cben[3]	AE14/5	PCI33_IN
cben[4]	AG15/5	PCI33_IN
cben[5]	AH12/5	PCI33_IN
cben[6]	AJ13/5	PCI33_IN
cben[7]	AD15/5	PCI33_IN
par	AG14/5	PCI33_BIDI
par64	AK10/5	PCI33_BIDI
PCI Interface Controls		
framen	AF15/5	PCI33_IN
irdyn	AK7/5	PCI33_IN
trdyn	AK6/5	PCI33_OUT
stopn	AH13/5	PCI33_OUT
idsel	AG13/5	PCI33_IN
devseln	AK8/5	PCI33_OUT
perrn	AK9/5	PCI33_OUT
serrn	AH14/5	PCI33_OUT
ack64n	AH15/5	PCI33_OUT
req64n	K11/5	PCI33_IN
PCI Interrupts		
intan	AJ12/5	PCI33_OUT



Компания «ЭлектроПласт» предлагает заключение долгосрочных отношений при поставках импортных электронных компонентов на взаимовыгодных условиях!

Наши преимущества:

- Оперативные поставки широкого спектра электронных компонентов отечественного и импортного производства напрямую от производителей и с крупнейших мировых складов;
- Поставка более 17-ти миллионов наименований электронных компонентов;
- Поставка сложных, дефицитных, либо снятых с производства позиций;
- Оперативные сроки поставки под заказ (от 5 рабочих дней);
- Экспресс доставка в любую точку России;
- Техническая поддержка проекта, помощь в подборе аналогов, поставка прототипов;
- Система менеджмента качества сертифицирована по Международному стандарту ISO 9001;
- Лицензия ФСБ на осуществление работ с использованием сведений, составляющих государственную тайну;
- Поставка специализированных компонентов (Xilinx, Altera, Analog Devices, Intersil, Interpoint, Microsemi, Aeroflex, Peregrine, Syfer, Eurofarad, Texas Instrument, Miteq, Cobham, E2V, MA-COM, Hittite, Mini-Circuits, General Dynamics и др.);

Помимо этого, одним из направлений компании «ЭлектроПласт» является направление «Источники питания». Мы предлагаем Вам помощь Конструкторского отдела:

- Подбор оптимального решения, техническое обоснование при выборе компонента;
- Подбор аналогов;
- Консультации по применению компонента;
- Поставка образцов и прототипов;
- Техническая поддержка проекта;
- Защита от снятия компонента с производства.



Как с нами связаться

Телефон: 8 (812) 309 58 32 (многоканальный)

Факс: 8 (812) 320-02-42

Электронная почта: org@eplast1.ru

Адрес: 198099, г. Санкт-Петербург, ул. Калинина, дом 2, корпус 4, литера А.