

The S-85S1A Series introduces own distinctive low power consumption control and COT (Constant On-Time) control and features ultra low current consumption and fast transient response. PWM / PFM switching control automatically switches to PFM control when under light load, and the IC operates at ultra low current consumption of 260 nA quiescent current. The S-85S1A Series realizes high efficiency in a wide range of load current consumption and provides strong support for extended period operation of mobile devices and wearable devices which are equipped with compact batteries.

The S-85S1A Series can configure a step-down regulator only with a coil, an input capacitor, and an output capacitor. By using external parts recommended in this datasheet, the occupancy area can be reduced to $2.0 \text{ mm} \times 4.5 \text{ mm} = 9.0 \text{ mm}^2$, and it contributes to miniaturization of electronic equipment.

■ Features

- Ultra low current consumption: 260 nA quiescent current
- Efficiency (when under 100 μA load): 90.5%
- Fast transient response: COT control
- Input voltage: 2.2 V to 5.5 V
- Output voltage: 0.7 V to 2.5 V, in 0.05 V step
2.6 V to 3.9 V, in 0.1 V step
- Output voltage accuracy: $\pm 1.5\%$ ($1.0 \text{ V} \leq V_{\text{OUT}} \leq 3.9 \text{ V}$)
 $\pm 15 \text{ mV}$ ($0.7 \text{ V} \leq V_{\text{OUT}} < 1.0 \text{ V}$)
- Switching frequency: 1.0 MHz (at PWM operation)
- High side power MOS FET on-resistance: 420 m Ω
- Low side power MOS FET on-resistance: 320 m Ω
- Soft-start function: 1 ms typ.
- Under voltage lockout function (UVLO): 1.8 V typ. (detection voltage)
- Thermal shutdown function: 135°C typ. (detection temperature)
- Overcurrent protection function: 450 mA (at L = 2.2 μH)
- Automatic recovery type short-circuit protection function: Hiccup control
- Input and output capacitors: Ceramic capacitor compatible
- Operation temperature range: $T_a = -40^\circ\text{C}$ to $+85^\circ\text{C}$
- Lead-free (Sn 100%), halogen-free

■ Applications

- Wearable device
- Bluetooth device
- Wireless sensor network device
- Healthcare equipment
- Smart meter
- Portable game device

■ Package

- SNT-6A
(1.80 mm \times 1.57 mm \times t0.5 mm max.)

■ Typical Application Circuit

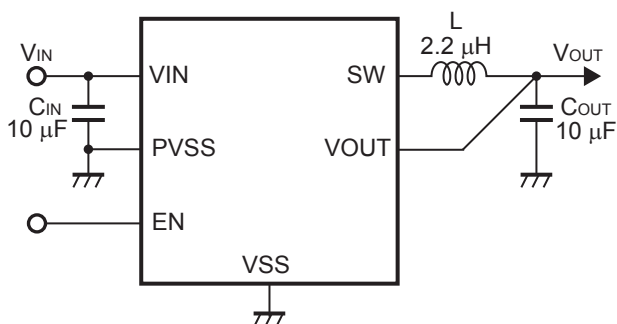

■ Efficiency

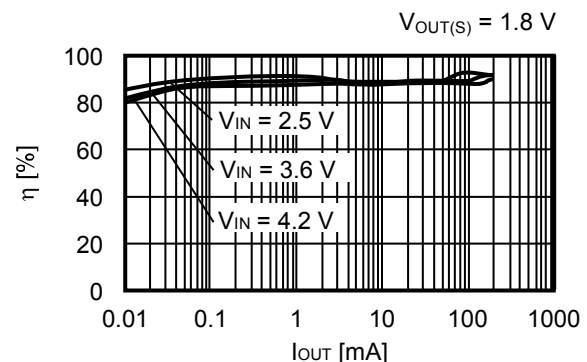

■ **Block Diagram**

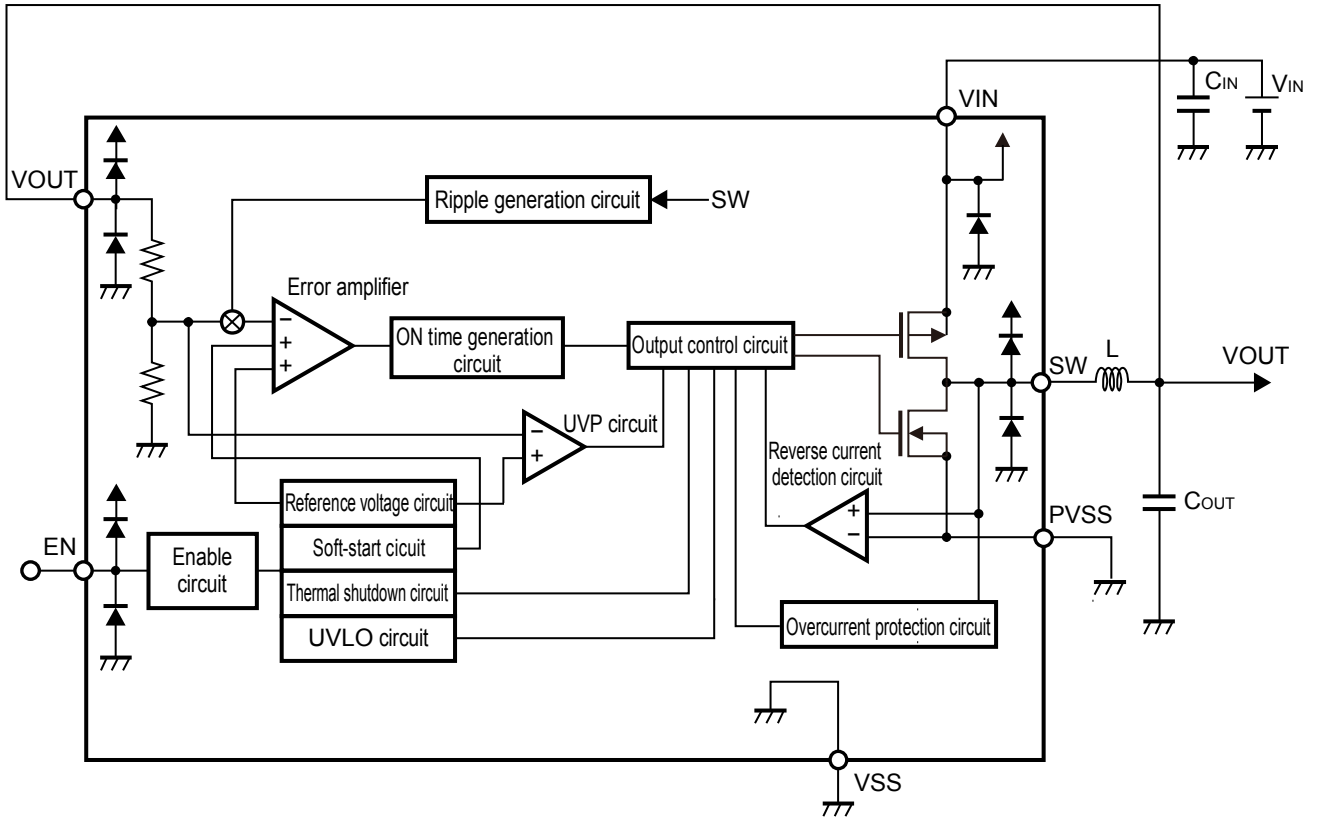

Figure 1

■ Product Name Structure

Users can select output voltage for the S-85S1A Series. Refer to "1. Product name" regarding the contents of product name, "2. Package" regarding the package, "3. Product name list" regarding details of the product name.

1. Product name



*1. Refer to the tape drawing.

*2. Refer to "3. Product name list".

*3. In the range from 0.7 V to 2.5 V, the products which have 0.05 V step are also available.
 Contact our sales office when the product is necessary.

2. Package

Table 1 Package Drawing Codes

Package Name	Dimension	Tape	Reel	Land
SNT-6A	PG006-A-P-SD	PG006-A-C-SD	PG006-A-R-SD	PG006-A-L-SD

3. Product name list

Table 2

Output Voltage (V_{OUT})	S-85S1A Series
0.7 V \pm 15 mV	S-85S1AB07-I6T1U
0.8 V \pm 15 mV	S-85S1AB08-I6T1U
0.9 V \pm 15 mV	S-85S1AB09-I6T1U
1.0 V \pm 1.5%	S-85S1AB10-I6T1U
1.1 V \pm 1.5%	S-85S1AB11-I6T1U
1.2 V \pm 1.5%	S-85S1AB12-I6T1U
1.3 V \pm 1.5%	S-85S1AB13-I6T1U
1.4 V \pm 1.5%	S-85S1AB14-I6T1U
1.5 V \pm 1.5%	S-85S1AB15-I6T1U
1.6 V \pm 1.5%	S-85S1AB16-I6T1U
1.7 V \pm 1.5%	S-85S1AB17-I6T1U
1.8 V \pm 1.5%	S-85S1AB18-I6T1U
1.9 V \pm 1.5%	S-85S1AB19-I6T1U
2.0 V \pm 1.5%	S-85S1AB20-I6T1U
2.1 V \pm 1.5%	S-85S1AB21-I6T1U
2.2 V \pm 1.5%	S-85S1AB22-I6T1U
2.3 V \pm 1.5%	S-85S1AB23-I6T1U
2.4 V \pm 1.5%	S-85S1AB24-I6T1U
2.5 V \pm 1.5%	S-85S1AB25-I6T1U
2.6 V \pm 1.5%	S-85S1AB26-I6T1U
2.7 V \pm 1.5%	S-85S1AB27-I6T1U
2.8 V \pm 1.5%	S-85S1AB28-I6T1U
2.9 V \pm 1.5%	S-85S1AB29-I6T1U
3.0 V \pm 1.5%	S-85S1AB30-I6T1U
3.1 V \pm 1.5%	S-85S1AB31-I6T1U
3.2 V \pm 1.5%	S-85S1AB32-I6T1U
3.3 V \pm 1.5%	S-85S1AB33-I6T1U
3.4 V \pm 1.5%	S-85S1AB34-I6T1U
3.5 V \pm 1.5%	S-85S1AB35-I6T1U
3.6 V \pm 1.5%	S-85S1AB36-I6T1U
3.7 V \pm 1.5%	S-85S1AB37-I6T1U
3.8 V \pm 1.5%	S-85S1AB38-I6T1U
3.9 V \pm 1.5%	S-85S1AB39-I6T1U

Remark Please contact our sales office for products with specifications other than the above.

■ Pin Configuration

1. SNT-6A

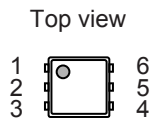

Figure 2

Table 3

Pin No.	Symbol	Description
1	VOUT	Voltage output pin
2	VSS	GND pin
3	SW	External inductor connection pin
4	PVSS	Power GND pin
5	VIN	Power supply pin
6	EN	Enable pin "H" : Enable (normal operation) "L" : Disable (standby)

■ **Absolute Maximum Ratings**

Table 4

(Unless otherwise specified: Ta = +25°C, V_{SS} = 0 V)

Item	Symbol	Absolute Maximum Rating	Unit
VIN pin voltage	V _{IN}	V _{SS} - 0.3 to V _{SS} + 6.0	V
EN pin voltage	V _{EN}	V _{SS} - 0.3 to V _{IN} + 0.3 ≤ V _{SS} + 6.0	V
VOOUT pin voltage	V _{OUT}	V _{SS} - 0.3 to V _{IN} + 0.3 ≤ V _{SS} + 6.0	V
SW pin voltage	V _{SW}	V _{SS} - 0.3 to V _{IN} + 0.3 ≤ V _{SS} + 6.0	V
PVSS pin voltage	V _{PVSS}	V _{SS} - 0.3 to V _{SS} + 0.3 ≤ V _{SS} + 6.0	V
Operation temperature	T _{opr}	-40 to +85	°C
Storage temperature	T _{stg}	-40 to +125	°C

Caution The absolute maximum ratings are rated values exceeding which the product could suffer physical damage. These values must therefore not be exceeded under any conditions.

■ **Thermal Resistance Value**

Table 5

Item	Symbol	Condition	Min.	Typ.	Max.	Unit	
Junction-to-ambient thermal resistance*1	θ _{JA}	SNT-6A	Board A	-	224	-	°C/W
			Board B	-	176	-	°C/W
			Board C	-	-	-	°C/W
			Board D	-	-	-	°C/W
			Board E	-	-	-	°C/W

*1. Test environment: compliance with JEDEC STANDARD JESD51-2A

Remark Refer to "■ Power Dissipation" and "Test Board" for details.

■ Electrical Characteristics

Table 6

($V_{IN} = 3.6\text{ V}^{*1}$, $T_a = +25^\circ\text{C}$ unless otherwise specified)

Item	Symbol	Condition	Min.	Typ.	Max.	Unit
Operating input voltage	V_{IN}	–	2.2	3.6	5.5	V
Output voltage ^{*2}	V_{OUT}	$1.0\text{ V} \leq V_{OUT} \leq 3.9\text{ V}$, no external parts	$V_{OUT(S)} \times 0.985$	$V_{OUT(S)}$	$V_{OUT(S)} \times 1.015$	V
		$0.7\text{ V} \leq V_{OUT} < 1.0\text{ V}$, no external parts	$V_{OUT(S)} - 0.015$	$V_{OUT(S)}$	$V_{OUT(S)} + 0.015$	V
Current consumption during shutdown	I_{SSS}	$V_{EN} = 0\text{ V}$	–	1	100	nA
Current consumption during switching off	I_{SS1}	$V_{OUT} = V_{OUT(S)} + 0.1\text{ V}$, $V_{EN} = V_{IN}$, no external parts, no switching operation	–	260	500	nA
High level input voltage	V_{SH}	$V_{IN} = 2.2\text{ V}$ to 5.5 V , EN pin	1.1	–	–	V
Low level input voltage	V_{SL}	$V_{IN} = 2.2\text{ V}$ to 5.5 V , EN pin	–	–	0.3	V
High level input current	I_{SH}	$V_{IN} = 2.2\text{ V}$ to 5.5 V , EN pin, $V_{EN} = V_{IN}$	–100	–	100	nA
Low level input current	I_{SL}	$V_{IN} = 2.2\text{ V}$ to 5.5 V , EN pin, $V_{EN} = 0\text{ V}$	–100	–	100	nA
High side power MOS FET on-resistance	R_{HFET}	$I_{SW} = 100\text{ mA}$	–	420	–	m Ω
Low side power MOS FET on-resistance	R_{LFET}	$I_{SW} = -100\text{ mA}$	–	320	–	m Ω
High side power MOS FET leakage current	I_{HSW}	$V_{IN} = 2.2\text{ V}$ to 5.5 V , $V_{EN} = 0\text{ V}$, $V_{SW} = 0\text{ V}$	–	1	100	nA
Low side power MOS FET leakage current	I_{LSW}	$V_{IN} = 2.2\text{ V}$ to 5.5 V , $V_{EN} = 0\text{ V}$, $V_{SW} = V_{IN}$	–100	1	–	nA
Current limit ^{*3}	I_{LIM}	$L = 2.2\text{ }\mu\text{H}$	–	450	–	mA
ON time ^{*4}	t_{ON}	$t_{ON(S)} = 1/f_{SW}^{*5} \times V_{OUT}/V_{IN}$, $V_{OUT} = V_{OUT(S)} \times 0.9$	$t_{ON(S)}/1.3$	$t_{ON(S)}$	$t_{ON(S)}/0.7$	ns
Minimum OFF time	$t_{OFF(MIN)}$	–	–	100	–	ns
UVLO detection voltage	V_{UVLO-}	When V_{IN} falls	1.7	1.8	1.9	V
UVLO release voltage	V_{UVLO+}	When V_{IN} rises	1.9	2.0	2.1	V
UVP detection voltage	V_{UVP}	–	–	$V_{OUT(S)} \times 0.7$	–	V
Soft-start wait time	t_{SSW}	Time until V_{OUT} starts rising	–	1.5	–	ms
Soft-start time	t_{SS}	Time until V_{OUT} reaches 90% after it starts rising	–	1.0	–	ms
Thermal shutdown detection temperature	T_{SD}	Junction temperature	–	135	–	$^\circ\text{C}$
Thermal shutdown release temperature	T_{SR}	Junction temperature	–	115	–	$^\circ\text{C}$

*1. $V_{IN} = V_{OUT(S)} + 1.0\text{ V}$ ($V_{OUT(S)} \geq 2.6\text{ V}$)

*2. V_{OUT} : Actual output voltage
 $V_{OUT(S)}$: Set output voltage

*3. The current limit changes according to the L value for the inductor to be used, input voltage, and output voltage. Refer to "■ Operation" for details.

*4. t_{ON} : Actual ON time
 $t_{ON(S)}$: Set ON time

*5. f_{SW} : Switching frequency (1 MHz)

■ Operation

1. Fast transient response

Distinctive COT (Constant On-Time) control is used for DC-DC converter control.

The S-85S1A Series monitors the output voltage (V_{OUT}) using a comparator and if V_{OUT} falls below the targeted value, the high side power MOS FET will turn on for a certain amount of time. Since the high side power MOS FET turns on and V_{OUT} rises immediately after the load current fluctuates rapidly and V_{OUT} falls, the fast transient response is realized.

The S-85S1A Series outputs ON time in proportion to V_{OUT} and in inverse proportion to power supply voltage. Therefore, when in continuous mode, even if the power supply voltage or V_{OUT} settings would change, it always operates at a quasi-fixed frequency of 1 MHz.

2. PWM / PFM switching control

The S-85S1A Series automatically switches between the pulse width modulation method (PWM) and pulse frequency modulation method (PFM) according to the load current. If the output current (I_{OUT}) is large, the IC will operate at PWM control. If I_{OUT} is small, the IC will operate at PFM control and the pulse will skip according to the load current. This reduces switching loss and improves efficiency when under light load.

The S-85S1A Series has a built-in reverse current detection circuit. The reverse current detection circuit monitors the current flowing through the inductor. If the bottom of ripple current in the inductor falls to 0 mA, the high side power MOS FET and low side power MOS FET will turn off and switching operation will stop. Switching frequency will fall from 1.0 MHz by skipping a pulse. This means that the smaller I_{OUT} is, the more the switching frequency (f_{SW}) will drop, and it reduces switching loss.

3. Ultra low current consumption

When in discontinuous mode, the S-85S1A Series reduces current consumption to 260 nA typ. by intermittently operating a control circuit and a protection circuit. When under light load, the high side power MOS FET and low side power MOS FET will turn off. When switching operation stops and a certain amount of time elapses, only the necessary circuits will operate.

Under voltage lockout function (UVLO), thermal shutdown function, current limit function, and automatic recovery type short-circuit protection function are prepared in the S-85S1A Series, and each protection function will carry out detection operation for a certain amount of time from when the high side power MOS FET turns on under light load. It is thus able to realize ultra low current consumption. When under heavy load, the IC changes to continuous mode as a result of the fact that the high side power MOS FET and low side power MOS FET turn on continuously, so all the IC, including the protection circuits, will operate.

4. EN pin

This pin starts and stops switching operation. When the EN pin is set to "L", the operation of all internal circuits, including the high side power MOS FET, is stopped, reducing current consumption. Current consumption increases when a voltage of 0.3 V to $V_{IN} - 0.3$ V is applied to the EN pin. When not using the EN pin, connect it to the VIN pin. Since the EN pin is neither pulled down nor pulled up internally, do not use it in the floating status. The structure of the EN pin is shown in **Figure 3**.

Table 7

EN Pin	Internal Circuit	V _{OUT} Pin Voltage
"H"	Enable (normal operation)	V_{OUT}^{*1}
"L"	Disable (standby)	"High-Z"

*1. Refer to *2 in Table 6 in "■ Electrical Characteristics".

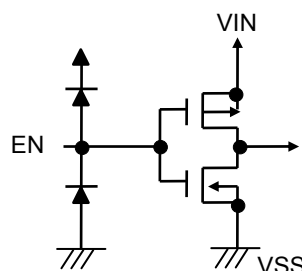

Figure 3

5. Under voltage lockout function (UVLO)

The S-85S1A Series has a built-in UVLO circuit to prevent the IC from malfunctioning due to a transient status at power-on or a momentary drop in the supply voltage. When UVLO status is detected, the high side power MOS FET and low side power MOS FET will turn off, and the SW pin will change to "High-Z". For this reason, switching operation will stop. The soft-start function is reset if UVLO status is detected once, and is restarted by releasing the UVLO status.

Note that the other internal circuits operate normally and the status is different from the disabled status.

Also, there is a hysteresis width for avoiding malfunctions due to generation of noise etc. in the input voltage.

6. Thermal shutdown function

The S-85S1A Series has a built-in thermal shutdown circuit to limit overheating. When the junction temperature increases to 135°C typ., the thermal shutdown circuit becomes the detection status, and the switching operation is stopped. When the junction temperature decreases to 115°C typ., the thermal shutdown circuit becomes the release status, and the switching operation is restarted.

If the thermal shutdown circuit becomes the detection status due to self-heating, the switching operation is stopped and output voltage (V_{OUT}) decreases. For this reason, the self-heating is limited and the temperature of the IC decreases. The thermal shutdown circuit becomes release status when the temperature of the IC decreases, and the switching operation is restarted, thus the self-heating is generated again. Repeating this procedure makes the waveform of V_{OUT} into a pulse-like form. Switching operation stopping and starting can be stopped by either setting the EN pin to "L", lowering the output current (I_{OUT}) to reduce internal power consumption, or decreasing the ambient temperature.

Table 8

Thermal Shutdown Circuit	VOUT Pin Voltage
Release: 115°C typ.*1	V_{OUT}
Detection: 135°C typ.*1	"High-Z"

*1. Junction temperature

7. Overcurrent protection function

The S-85S1A Series has a built-in current limit circuit.

The overcurrent protection circuit monitors the current that flows through the low side power MOS FET and limits current to prevent thermal destruction of the IC due to an overload, magnetic saturation in the inductor, etc.

When a current exceeding the current limit (I_{LIM}) flows through the low side power MOS FET, the current limit circuit operates and prohibits turning on the high side power MOS FET until the current falls below the low side current limit (I_{LIMDET}). If the value of the current that flows through the low side power MOS FET falls to the I_{LIMDET} or lower, the S-85S1A Series returns to normal operation. I_{LIMDET} is fixed at 270 mA typ. in the IC, and I_{LIM} will vary depending on the external parts to be used.

The relation between I_{LIM} , the inductor value (L), the input voltage (V_{IN}), and the output voltage (V_{OUT}) are shown in the following expression.

$$I_{LIM} = I_{LIMDET} + \frac{1}{2 \times L \times f_{SW}} \times \frac{(V_{IN} - V_{OUT}) \times V_{OUT}}{V_{IN}}$$

8. Automatic recovery type short-circuit protection function (Hiccup control)

The S-85S1A Series has a built-in automatic recovery type short-circuit protection function for Hiccup control. Hiccup control is a method for periodically carrying out automatic recovery when the IC detects overcurrent and stops the switching operation.

8.1 When over load status is released

- <1> Overcurrent detection
- <2> Under voltage protection circuit (UVP circuit) detects a drop in the output voltage (V_{OUT}).
- <3> 220 μ s elapse
- <4> Switching operation stop (for 9 ms typ.)
- <5> Overload status release
- <6> The IC restarts, soft-start function starts.
 In this case, it is unnecessary to input an external reset signal for restart.
- <7> V_{OUT} reaches $V_{OUT(S)}$ after 1.0 ms typ. elapses.



*1. Inductor current

Figure 4

8.2 When over load status continues

- <1> Overcurrent detection
- <2> The UVP circuit detects a drop in V_{OUT} .
- <3> 220 μ s elapse
- <4> Switching operation stop (for 9 ms typ.)
- <5> The IC restarts, soft-start function starts.
- <6> The status returns to <2> when over load status continues after 1.25 ms typ. elapses.



*1. Inductor current

Figure 5

9. Pre-bias compatible soft-start function

The S-85S1A Series has a built-in pre-bias compatible soft-start circuit.

If the pre-bias compatible soft-start circuit starts when electrical charge remains in the output voltage (V_{OUT}) as a result of power supply restart, etc., or when V_{OUT} is biased beforehand (pre-bias status), switching operation is stopped until the soft-start voltage exceeds the internal feedback voltage, and then V_{OUT} is maintained. If the soft-start voltage exceeds the internal feedback voltage, switching operation will restart and V_{OUT} will rise to the output voltage setting value ($V_{OUT(S)}$). This allows $V_{OUT(S)}$ to be reached without lowering the pre-biased V_{OUT} .

In soft-start circuits which are not pre-bias compatible, a large current flows as a result of the discharge of the residual electric charge through the low side power MOS FET when switching operation starts, which could cause damage, however in a pre-bias compatible soft-start circuit, the IC is protected from the large current when switching operation starts, and it makes power supply design for the application circuit simpler.

In the S-85S1A Series, V_{OUT} reaches $V_{OUT(S)}$ gradually due to the soft-start circuit.

In the following cases, rush current and V_{OUT} overshoot are reduced.

- At power-on
- When the EN pin changes from "L" to "H".
- When UVLO operation is released.
- When thermal shutdown is released.
- At short-circuit recovery

In addition, the soft-start circuit operates under the following conditions.

The soft-start circuit starts operating after "H" is input to the EN pin and the soft-start wait time (t_{SSW}) = 1.5 ms typ. elapses. The soft-start time (t_{SS}) is set to 1.0 ms typ.

- At power supply restart (the IC restart)
- At UVLO detection (after UVLO release)
- At thermal shutdown detection (after thermal shutdown release)
- After Hiccup control



Figure 6

■ **Typical Circuit**



Figure 7

Caution The above connection diagram and constants will not guarantee successful operation. Perform thorough evaluation using an actual application to set the constants.

External Parts Selection

Selectable values and recommended values for external parts are shown in **Table 9**.
Use ceramic capacitors for C_{IN} and C_{OUT} .

Table 9

Item	Input Capacitor (C_{IN})	Output Capacitor (C_{OUT})	Inductor (L)
Selectable value	2.2 μ F or larger	4.7 μ F to 100 μ F	1.5 μ H to 10 μ H
Recommended value	10 μ F	10 μ F	2.2 μ H

1. Input capacitor (C_{IN})

C_{IN} can lower the power supply impedance, average the input current, improve the efficiency and noise tolerance. Select a capacitor according to the impedance of the power supply to be used. Also take into consideration the DC bias characteristics of the capacitor to be used.

2. Output capacitor (C_{OUT})

C_{OUT} is used to smooth output voltage. If the capacitance is large, the overshoot and undershoot during load transient and output ripple voltage can be improved even more. Select a proper capacitor after the sufficient evaluation under actual conditions.

Table 10 Recommended Capacitors (C_{IN} , C_{OUT}) List (at $V_{OUT(S)} \leq 3.3$ V)

Manufacturer	Part Number	Capacitance	Withstanding Voltage	Dimensions (L × W × H)
Murata Manufacturing Co., Ltd.	GRM155R60J106ME15	10 μ F	6.3 V	1.0 mm × 0.5 mm × 0.5 mm
TDK Corporation	C1608X5R0J106K080AB	10 μ F	6.3 V	1.6 mm × 0.8 mm × 0.8 mm
Murata Manufacturing Co., Ltd.	GRM185R60J106ME15	10 μ F	6.3 V	1.6 mm × 0.8 mm × 0.5 mm

Table 11 Recommended Capacitors (C_{IN} , C_{OUT}) List (at $V_{OUT(S)} > 3.3$ V)

Manufacturer	Part Number	Capacitance	Withstanding Voltage	Dimensions (L × W × H)
TDK Corporation	C1608X5R0J106K080AB	10 μ F	6.3 V	1.6 mm × 0.8 mm × 0.8 mm
Murata Manufacturing Co., Ltd.	GRM185R60J106ME15	10 μ F	6.3 V	1.6 mm × 0.8 mm × 0.5 mm

3. Inductor (L)

When selecting L, note the allowable current. If a current exceeding this allowable current flows through the inductor, magnetic saturation may occur, and there may be risks which substantially lower efficiency and damage the IC as a result of large current.

Therefore, select an inductor so that peak current value (I_{PK}), even during overcurrent detection, does not exceed the allowable current.

When prioritizing the load response, select an inductor with a small L value such as 2.2 μ H. When prioritizing the efficiency, select an inductor with a large L value such as 10 μ H. I_{PK} is calculated using the following expression.

$$I_{PK} = I_{OUT} + \frac{1}{2 \times L \times f_{SW}} \times \frac{(V_{IN} - V_{OUT}) \times V_{OUT}}{V_{IN}}$$

Table 12 Recommended Inductors (L) List

Manufacturer	Part Number	Inductance	Rated Current	Dimensions (L × W × H)
ALPS ELECTRIC CO., LTD.	GLUHK2R201A	2.2 μ H	1700 mA	2.0 mm × 1.6 mm × 1.0 mm
Murata Manufacturing Co., Ltd.	DFE201210S-2R2M=P2	2.2 μ H	2000 mA	2.0 mm × 1.2 mm × 1.0 mm
Würth Elektronik GmbH & Co. KG	74438343022	2.2 μ H	1100 mA	2.0 mm × 1.6 mm × 1.0 mm
Murata Manufacturing Co., Ltd.	LQM2MPN2R2MGH	2.2 μ H	1300 mA	2.0 mm × 1.6 mm × 0.9 mm
TDK Corporation	MLP2016G2R2M	2.2 μ H	850 mA	2.0 mm × 1.6 mm × 1.0 mm
Coilcraft, Inc.	PFL2015-222ME	2.2 μ H	1050 mA	2.2 mm × 1.45 mm × 1.5 mm

■ Board Layout Guidelines

Note the following cautions when determining the board layout for the S-85S1A Series.

- Place C_{IN} as close to the VIN pin and the PVSS pin as possible.
- Make the VIN pattern and GND pattern as wide as possible.
- Place thermal vias in the GND pattern to ensure sufficient heat dissipation.
- Keep thermal vias near C_{IN} and C_{OUT} approximately 3 mm to 4 mm away from capacitor pins.
- Large current flows through the SW pin. Make the wiring area of the pattern to be connected to the SW pin small to minimize parasitic capacitance and emission noise.
- Do not wire the SW pin pattern under the IC.

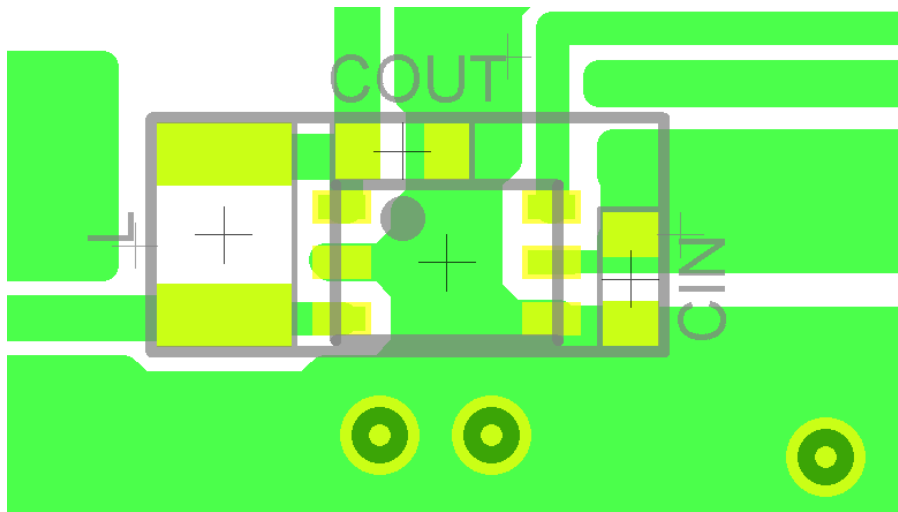

Total size 2.0 mm × 4.5 mm = 9.0 mm²

Figure 8 Reference Board Pattern

Caution The above pattern diagram does not guarantee successful operation. Perform thorough evaluation using the actual application to determine the pattern.

Remark Refer to the land drawing of SNT-6A and "SNT Package User's Guide".

■ Precautions

- Mount external capacitors and inductors as close as possible to the IC, and make single GND.
- Characteristic ripple voltage and spike noise occur in the IC containing switching regulators. Moreover rush current flows at the time of a power supply injection. Because these largely depend on the inductor, the capacitor and impedance of power supply to be used, fully check them using an actually mounted model.
- The 10 μ F capacitor connected between the VIN pin and the VSS pin is a bypass capacitor. It stabilizes the power supply in the IC when application is used with a heavy load, and thus effectively works for stable switching regulator operation. Allocate the bypass capacitor as close to the IC as possible, prioritized over other parts.
- Although the IC contains a static electricity protection circuit, static electricity or voltage that exceeds the limit of the protection circuit should not be applied.
- The power dissipation of the IC greatly varies depending on the size and material of the board to be connected. Perform sufficient evaluation using an actual application before designing.
- ABLIC Inc. assumes no responsibility for the way in which this IC is used on products created using this IC or for the specifications of that product, nor does ABLIC Inc. assume any responsibility for any infringement of patents or copyrights by products that include this IC either in Japan or in other countries.

■ **Characteristics (Typical Data)**

1. Example of major power supply dependence characteristics (Ta = +25°C)

1.1 Current consumption during switching off (I_{SS1}) vs. Input voltage (V_{IN})

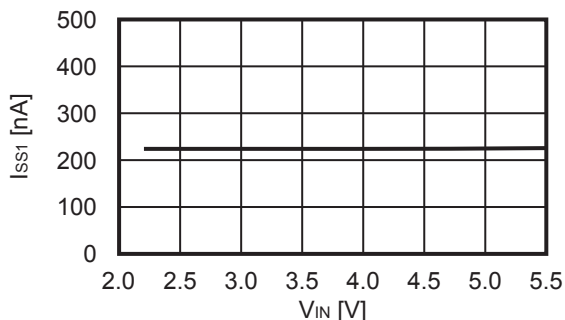

1.2 Current consumption during shutdown (I_{SSS}) vs. Input voltage (V_{IN})

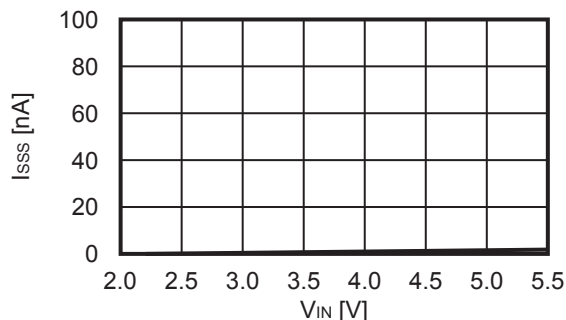

1.3 Output voltage (V_{OUT}) vs. Input voltage (V_{IN})
 V_{OUT(S)} = 1.2 V

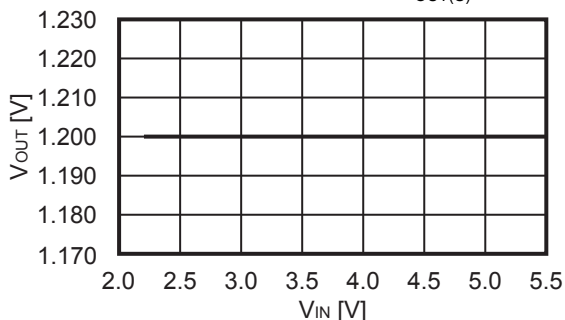

1.4 Output voltage (V_{OUT}) vs. Input voltage (V_{IN})
 V_{OUT(S)} = 1.8 V

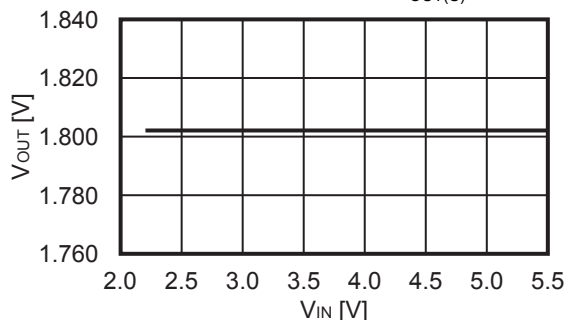

1.5 Output voltage (V_{OUT}) vs. Input voltage (V_{IN})
 V_{OUT(S)} = 2.5 V

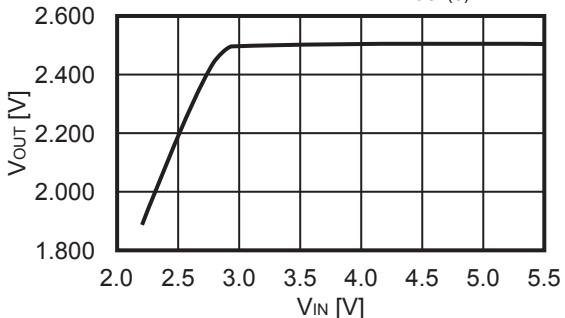

1.6 ON time (t_{ON}) vs. Input voltage (V_{IN})
 V_{OUT(S)} = 1.8 V

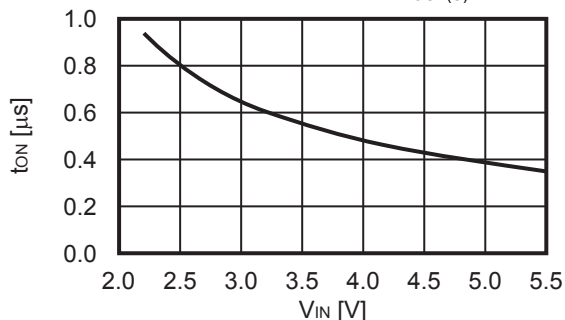

1.7 Switching frequency (f_{SW}) vs. Input voltage (V_{IN})
 V_{OUT(S)} = 1.8 V

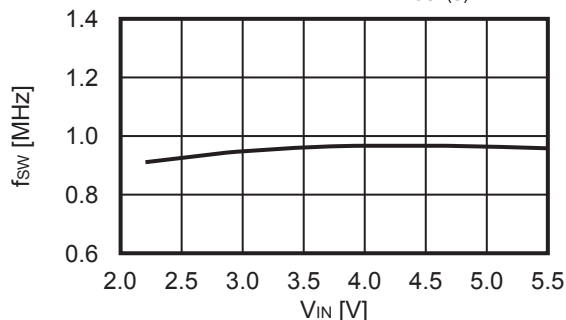

1. 8 Soft-start wait time (t_{SSW}) vs. Input voltage (V_{IN})



1. 9 Soft-start time (t_{SS}) vs. Input voltage (V_{IN})



1. 10 High side power MOS FET on-resistance (R_{HFET}) vs. Input voltage (V_{IN})



1. 11 Low side power MOS FET on-resistance (R_{LFET}) vs. Input voltage (V_{IN})



1. 12 High side power MOS FET leakage current (I_{HSW}) vs. Input voltage (V_{IN})



1. 13 Low side power MOS FET leakage current (I_{LSW}) vs. Input voltage (V_{IN})

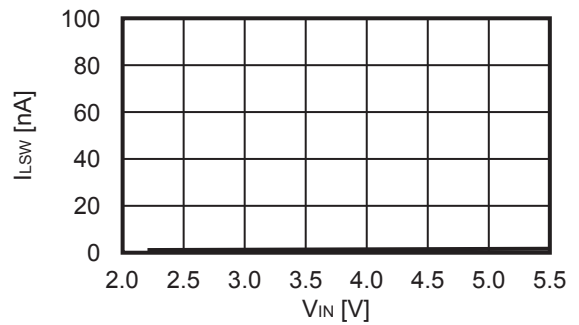

1. 14 High level input voltage (V_{SH}) vs. Input voltage (V_{IN})



1. 15 Low level input voltage (V_{SL}) vs. Input voltage (V_{IN})



2. Example of major temperature characteristics (Ta = -40°C to +85°C)

2.1 Current consumption during switching off (Iss1) vs. Temperature (Ta)



2.2 Current consumption during shutdown (Isss) vs. Temperature (Ta)

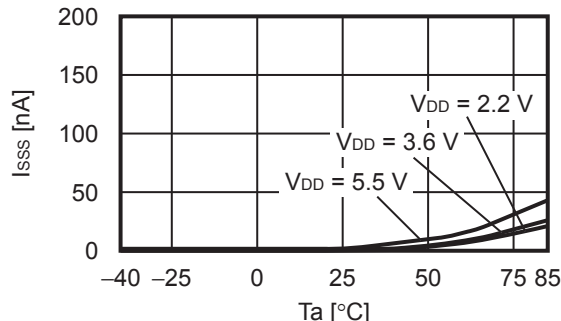

2.3 Output voltage (VOUT) vs. Temperature (Ta)



2.4 Output voltage (VOUT) vs. Temperature (Ta)

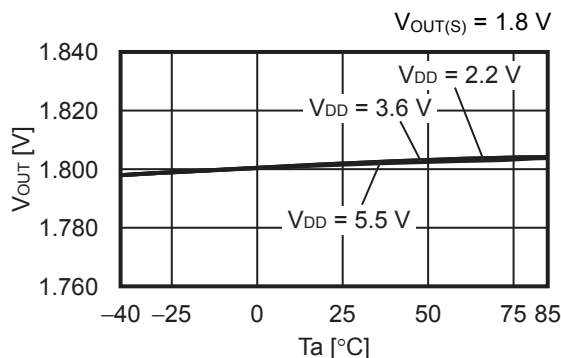

2.5 Output voltage (VOUT) vs. Temperature (Ta)



2.6 ON time (ton) vs. Temperature (Ta)

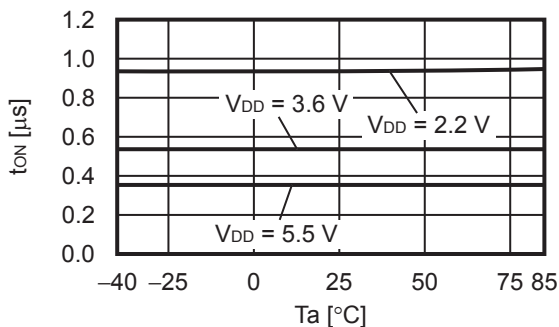

2.7 Switching frequency (fsw) vs. Temperature (Ta)

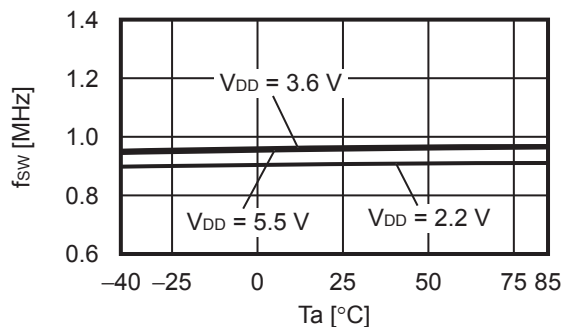

2. 8 Soft-start wait time (t_{SSW}) vs. Temperature (T_a)

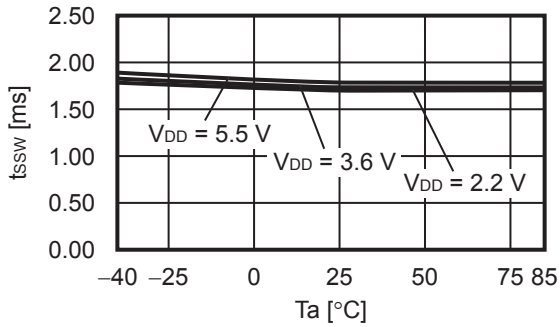

2. 9 Soft-start time (t_{SS}) vs. Temperature (T_a)

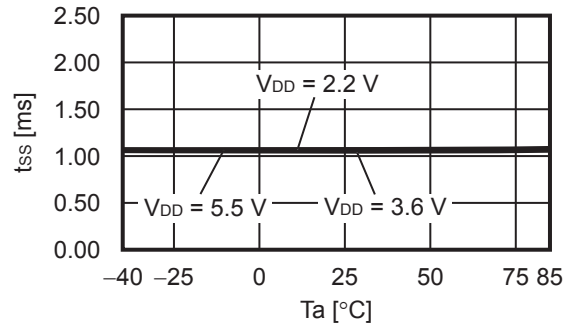

2. 10 High side power MOS FET on-resistance (R_{HFET}) vs. Temperature (T_a)

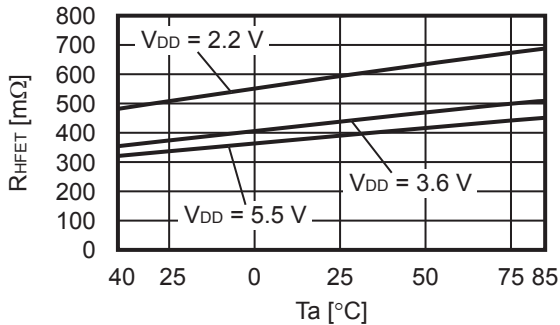

2. 11 Low side power MOS FET on-resistance (R_{LFET}) vs. Temperature (T_a)

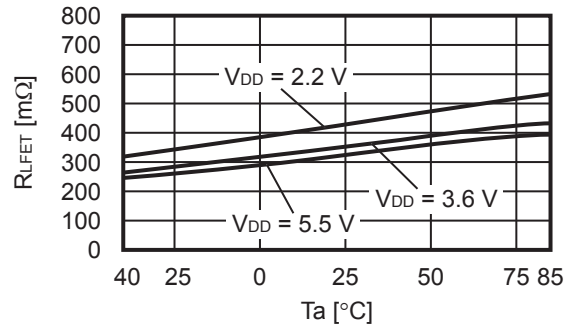

2. 12 High side power MOS FET leakage current (I_{HSW}) vs. Temperature (T_a)

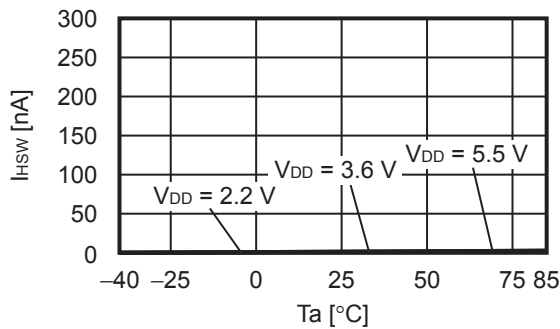

2. 13 Low side power MOS FET leakage current (I_{LSW}) vs. Temperature (T_a)

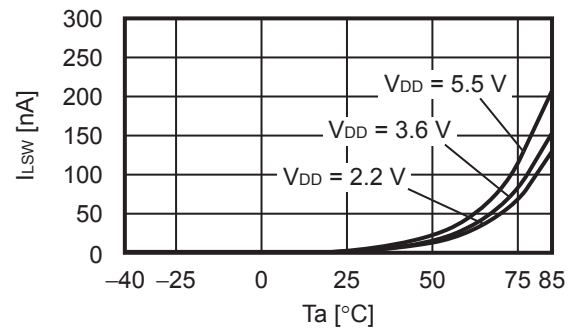

2. 14 High level input voltage (V_{SH}) vs. Temperature (T_a)

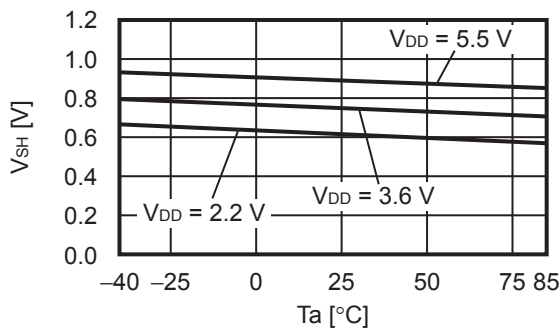

2. 15 Low level input voltage (V_{SL}) vs. Temperature (T_a)



2. 16 UVLO detection voltage (V_{UVLO-}) vs. Temperature (T_a)

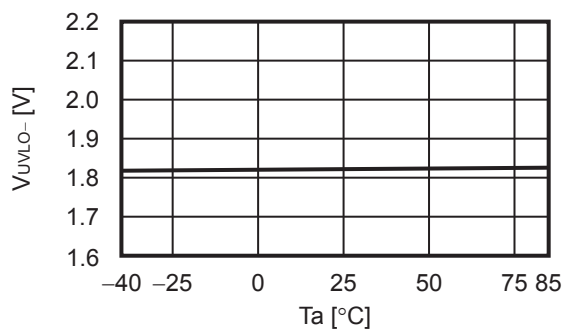

2. 17 UVLO release voltage (V_{UVLO+}) vs. Temperature (T_a)

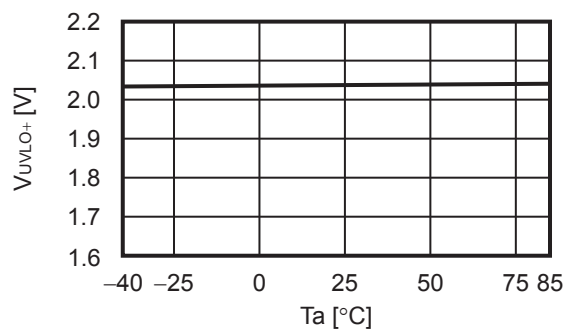

3. Transient response characteristics

The external parts shown in Table 13 are used in "3. Transient response characteristics".

Table 13

Element Name	Constant	Manufacturer	Part Number
Inductor	2.2 μ H	ALPS ELECTRIC CO., LTD.	GLUHK2R201A
Input capacitor	10 μ F	TDK Corporation	C1608X5R0J106K080AB
Output capacitor	10 μ F	TDK Corporation	C1608X5R0J106K080AB

3.1 Power-on ($V_{OUT} = 1.8$ V, $V_{IN} = 0$ V \rightarrow 3.6 V, $T_a = +25^\circ$ C)

3.1.1 $I_{OUT} = 0.1$ mA



3.1.2 $I_{OUT} = 200$ mA



3.2 Transient response characteristics of EN pin

($V_{OUT} = 1.8$ V, $V_{IN} = 3.6$ V, $V_{EN} = 0$ V \rightarrow 3.6 V, $T_a = +25^\circ$ C)

3.2.1 $I_{OUT} = 0.1$ mA



3.2.2 $I_{OUT} = 200$ mA



3.3 Power supply fluctuation ($V_{OUT} = 1.8$ V, $T_a = +25^\circ$ C)

3.3.1 $I_{OUT} = 0.1$ mA



3.3.2 $I_{OUT} = 200$ mA



3. 4 Load fluctuation ($V_{OUT} = 1.8\text{ V}$, $V_{IN} = 3.6\text{ V}$, $T_a = +25^\circ\text{C}$)

3. 4. 1 $I_{OUT} = 0.1\text{ mA} \rightarrow 10\text{ mA} \rightarrow 0.1\text{ mA}$

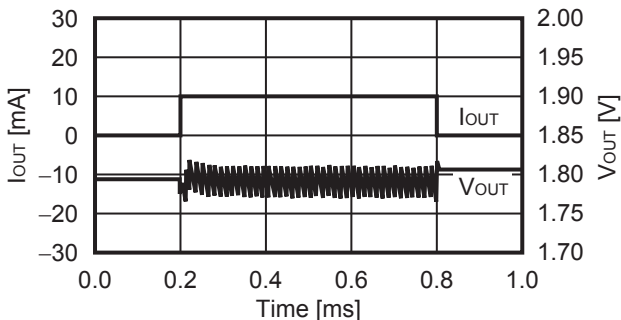

3. 4. 2 $I_{OUT} = 0.1\text{ mA} \rightarrow 200\text{ mA} \rightarrow 0.1\text{ mA}$

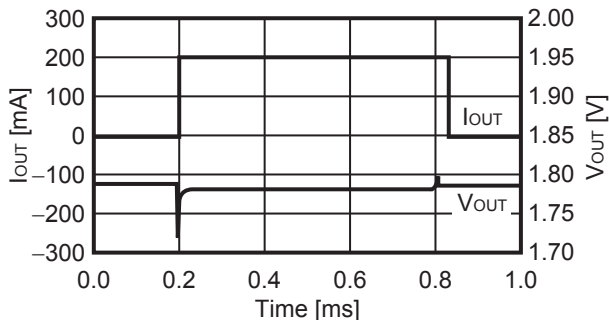

■ Reference Data

The external parts shown in **Table 14** are used in "■ Reference Data".

Table 14

Condition	Inductor (L)	Input Capacitor (C_{IN})	Output Capacitor (C_{OUT})
<1>	GLUHK2R201A (2.2 μH) ALPS ELECTRIC CO., LTD	C1005X5R0J106M050BC (10 μF) TDK Corporation	C1005X5R0J106M050BC (10 μF) TDK Corporation
<2>	DFE201210S (2.2 μH) Toko Ink.	C1005X5R0J106M050BC (10 μF) TDK Corporation	C1005X5R0J106M050BC (10 μF) TDK Corporation

1. $V_{OUT} = 1.2\text{ V}$ (External parts: Condition<1>)

1. 1 Efficiency (η) vs. Output current (I_{OUT})

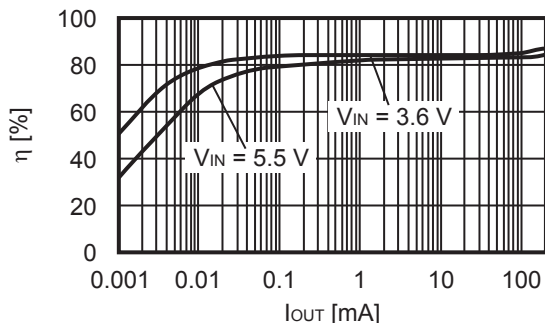

1. 2 Output voltage (V_{OUT}) vs. Output current (I_{OUT})

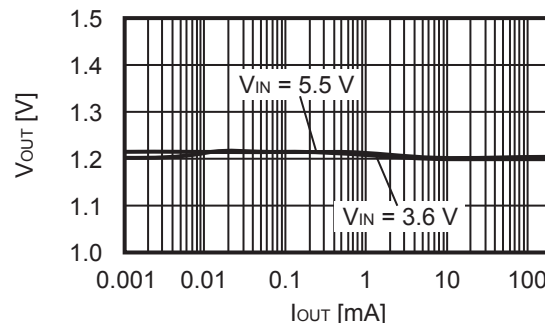

2. $V_{OUT} = 1.8\text{ V}$ (External parts: Condition<1>)

2. 1 Efficiency (η) vs. Output current (I_{OUT})

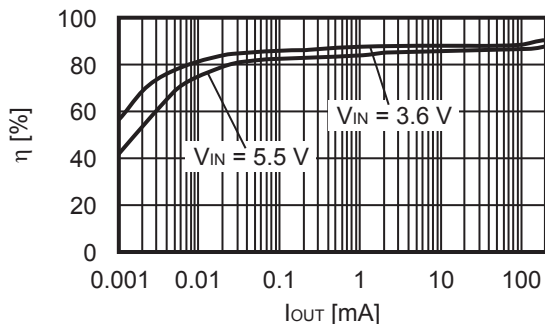

2. 2 Output voltage (V_{OUT}) vs. Output current (I_{OUT})

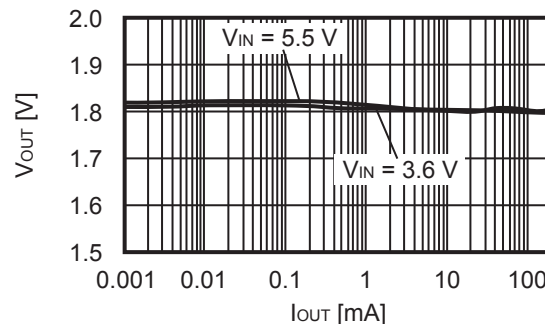

3. $V_{OUT} = 1.2\text{ V}$ (External parts: Condition<2>)

3.1 Efficiency (η) vs. Output current (I_{OUT})

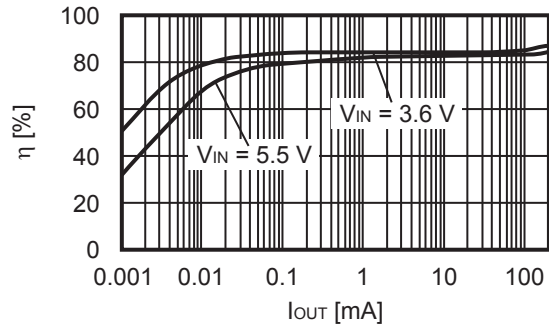

3.2 Output voltage (V_{OUT}) vs. Output current (I_{OUT})

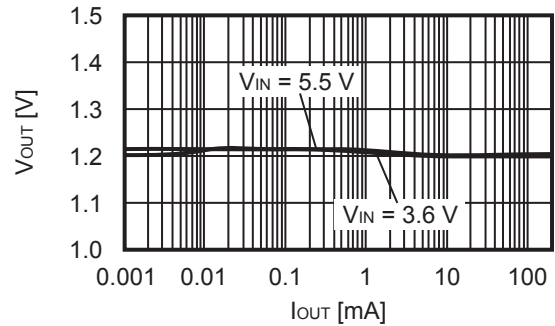

4. $V_{OUT} = 1.8\text{ V}$ (External parts: Condition<2>)

4.1 Efficiency (η) vs. Output current (I_{OUT})

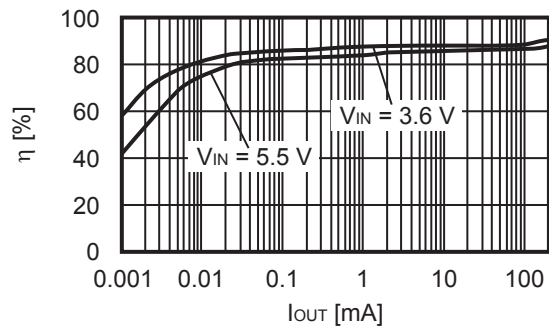

4.2 Output voltage (V_{OUT}) vs. Output current (I_{OUT})

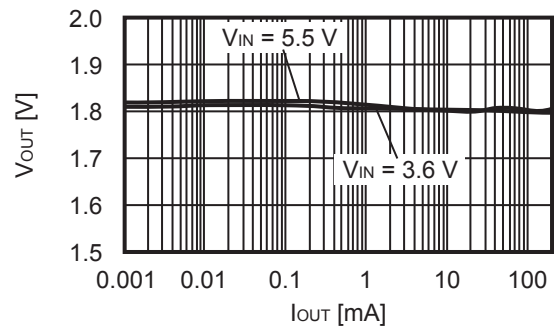

■ **Power Dissipation**

SNT-6A



Board	Power Dissipation (P_D)
A	0.45 W
B	0.57 W
C	–
D	–
E	–

SNT-6A Test Board

(1) Board A

 IC Mount Area



Item		Specification
Size [mm]		114.3 x 76.2 x t1.6
Material		FR-4
Number of copper foil layer		2
Copper foil layer [mm]	1	Land pattern and wiring for testing: t0.070
	2	-
	3	-
	4	74.2 x 74.2 x t0.070
Thermal via		-

(2) Board B

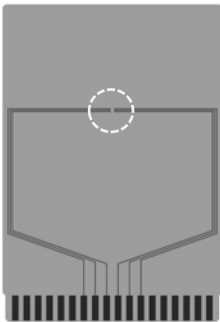

Item		Specification
Size [mm]		114.3 x 76.2 x t1.6
Material		FR-4
Number of copper foil layer		4
Copper foil layer [mm]	1	Land pattern and wiring for testing: t0.070
	2	74.2 x 74.2 x t0.035
	3	74.2 x 74.2 x t0.035
	4	74.2 x 74.2 x t0.070
Thermal via		-

No. SNT6A-A-Board-SD-1.0



No. PG006-A-P-SD-2.1

TITLE	SNT-6A-A-PKG Dimensions
No.	PG006-A-P-SD-2.1
ANGLE	
UNIT	mm
ABLIC Inc.	

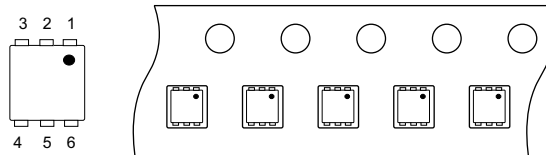

No. PG006-A-C-SD-2.0

TITLE	SNT-6A-A-Carrier Tape
No.	PG006-A-C-SD-2.0
ANGLE	
UNIT	mm
ABLIC Inc.	



Enlarged drawing in the central part



No. PG006-A-R-SD-1.0

TITLE	SNT-6A-A-Reel		
No.	PG006-A-R-SD-1.0		
ANGLE		QTY.	5,000
UNIT	mm		
ABLIC Inc.			



※1. ランドパターンの幅に注意してください (0.25 mm min. / 0.30 mm typ.).
 ※2. パッケージ中央にランドパターンを広げないでください (1.30 mm ~ 1.40 mm)。

- 注意
1. パッケージのモールド樹脂下にシルク印刷やハンダ印刷などしないでください。
 2. パッケージ下の配線上のソルダーレジストなどの厚みをランドパターン表面から0.03 mm以下にしてください。
 3. マスク開口サイズと開口位置はランドパターンと合わせてください。
 4. 詳細は "SNTパッケージ活用の手引き" を参照してください。

※1. Pay attention to the land pattern width (0.25 mm min. / 0.30 mm typ.).
 ※2. Do not widen the land pattern to the center of the package (1.30 mm ~ 1.40 mm).

- Caution**
1. Do not do silkscreen printing and solder printing under the mold resin of the package.
 2. The thickness of the solder resist on the wire pattern under the package should be 0.03 mm or less from the land pattern surface.
 3. Match the mask aperture size and aperture position with the land pattern.
 4. Refer to "SNT Package User's Guide" for details.

※1. 请注意焊盘模式的宽度 (0.25 mm min. / 0.30 mm typ.).
 ※2. 请勿向封装中间扩展焊盘模式 (1.30 mm ~ 1.40 mm)。

- 注意
1. 请勿在树脂型封装的下面印刷丝网、焊锡。
 2. 在封装下、布线上的阻焊膜厚度 (从焊盘模式表面起) 请控制在 0.03 mm 以下。
 3. 钢网的开口尺寸和开口位置请与焊盘模式对齐。
 4. 详细内容请参阅 "SNT 封装的应用指南"。

No. PG006-A-L-SD-4.1

TITLE	SNT-6A-A -Land Recommendation
No.	PG006-A-L-SD-4.1
ANGLE	
UNIT	mm
ABLIC Inc.	

Disclaimers (Handling Precautions)

1. All the information described herein (product data, specifications, figures, tables, programs, algorithms and application circuit examples, etc.) is current as of publishing date of this document and is subject to change without notice.
2. The circuit examples and the usages described herein are for reference only, and do not guarantee the success of any specific mass-production design.
ABLIC Inc. is not liable for any losses, damages, claims or demands caused by the reasons other than the products described herein (hereinafter "the products") or infringement of third-party intellectual property right and any other right due to the use of the information described herein.
3. ABLIC Inc. is not liable for any losses, damages, claims or demands caused by the incorrect information described herein.
4. Be careful to use the products within their ranges described herein. Pay special attention for use to the absolute maximum ratings, operation voltage range and electrical characteristics, etc.
ABLIC Inc. is not liable for any losses, damages, claims or demands caused by failures and / or accidents, etc. due to the use of the products outside their specified ranges.
5. Before using the products, confirm their applications, and the laws and regulations of the region or country where they are used and verify suitability, safety and other factors for the intended use.
6. When exporting the products, comply with the Foreign Exchange and Foreign Trade Act and all other export-related laws, and follow the required procedures.
7. The products are strictly prohibited from using, providing or exporting for the purposes of the development of weapons of mass destruction or military use. ABLIC Inc. is not liable for any losses, damages, claims or demands caused by any provision or export to the person or entity who intends to develop, manufacture, use or store nuclear, biological or chemical weapons or missiles, or use any other military purposes.
8. The products are not designed to be used as part of any device or equipment that may affect the human body, human life, or assets (such as medical equipment, disaster prevention systems, security systems, combustion control systems, infrastructure control systems, vehicle equipment, traffic systems, in-vehicle equipment, aviation equipment, aerospace equipment, and nuclear-related equipment), excluding when specified for in-vehicle use or other uses by ABLIC, Inc. Do not apply the products to the above listed devices and equipments.
ABLIC Inc. is not liable for any losses, damages, claims or demands caused by unauthorized or unspecified use of the products.
9. In general, semiconductor products may fail or malfunction with some probability. The user of the products should therefore take responsibility to give thorough consideration to safety design including redundancy, fire spread prevention measures, and malfunction prevention to prevent accidents causing injury or death, fires and social damage, etc. that may ensue from the products' failure or malfunction.
The entire system in which the products are used must be sufficiently evaluated and judged whether the products are allowed to apply for the system on customer's own responsibility.
10. The products are not designed to be radiation-proof. The necessary radiation measures should be taken in the product design by the customer depending on the intended use.
11. The products do not affect human health under normal use. However, they contain chemical substances and heavy metals and should therefore not be put in the mouth. The fracture surfaces of wafers and chips may be sharp. Be careful when handling these with the bare hands to prevent injuries, etc.
12. When disposing of the products, comply with the laws and ordinances of the country or region where they are used.
13. The information described herein contains copyright information and know-how of ABLIC Inc. The information described herein does not convey any license under any intellectual property rights or any other rights belonging to ABLIC Inc. or a third party. Reproduction or copying of the information from this document or any part of this document described herein for the purpose of disclosing it to a third-party is strictly prohibited without the express permission of ABLIC Inc.
14. For more details on the information described herein or any other questions, please contact ABLIC Inc.'s sales representative.
15. This Disclaimers have been delivered in a text using the Japanese language, which text, despite any translations into the English language and the Chinese language, shall be controlling.

2.4-2019.07

Mouser Electronics

Authorized Distributor

Click to View Pricing, Inventory, Delivery & Lifecycle Information:

ABLIC:

[S-85S1AB32-I6T1U](#) [S-85S1AB33-I6T1U](#) [S-85S1AB16-I6T1U](#) [S-85S1AB17-I6T1U](#) [S-85S1AB34-I6T1U](#) [S-85S1AB14-I6T1U](#) [S-85S1AB28-I6T1U](#) [S-85S1AB35-I6T1U](#) [S-85S1AB26-I6T1U](#) [S-85S1AB24-I6T1U](#) [S-85S1AB25-I6T1U](#) [S-85S1AB22-I6T1U](#) [S-85S1AB08-I6T1U](#) [S-85S1AB13-I6T1U](#) [S-85S1AB09-I6T1U](#) [S-85S1AB39-I6T1U](#) [S-85S1AB20-I6T1U](#) [S-85S1AB11-I6T1U](#) [S-85S1AB15-I6T1U](#) [S-85S1AB29-I6T1U](#) [S-85S1AB36-I6T1U](#) [S-85S1AB19-I6T1U](#) [S-85S1AB37-I6T1U](#) [S-85S1AB12-I6T1U](#) [S-85S1AB38-I6T1U](#) [S-85S1AB31-I6T1U](#) [S-85S1AB21-I6T1U](#) [S-85S1AB18-I6T1U](#) [S-85S1AB07-I6T1U](#) [S-85S1AB30-I6T1U](#) [S-85S1AB27-I6T1U](#) [S-85S1AB10-I6T1U](#) [S-85S1AB23-I6T1U](#)



Компания «ЭлектроПласт» предлагает заключение долгосрочных отношений при поставках импортных электронных компонентов на взаимовыгодных условиях!

Наши преимущества:

- Оперативные поставки широкого спектра электронных компонентов отечественного и импортного производства напрямую от производителей и с крупнейших мировых складов;
- Поставка более 17-ти миллионов наименований электронных компонентов;
- Поставка сложных, дефицитных, либо снятых с производства позиций;
- Оперативные сроки поставки под заказ (от 5 рабочих дней);
- Экспресс доставка в любую точку России;
- Техническая поддержка проекта, помощь в подборе аналогов, поставка прототипов;
- Система менеджмента качества сертифицирована по Международному стандарту ISO 9001;
- Лицензия ФСБ на осуществление работ с использованием сведений, составляющих государственную тайну;
- Поставка специализированных компонентов (Xilinx, Altera, Analog Devices, Intersil, Interpoint, Microsemi, Aeroflex, Peregrine, Syfer, Eurofarad, Texas Instrument, Miteq, Cobham, E2V, MA-COM, Hittite, Mini-Circuits, General Dynamics и др.);

Помимо этого, одним из направлений компании «ЭлектроПласт» является направление «Источники питания». Мы предлагаем Вам помощь Конструкторского отдела:

- Подбор оптимального решения, техническое обоснование при выборе компонента;
- Подбор аналогов;
- Консультации по применению компонента;
- Поставка образцов и прототипов;
- Техническая поддержка проекта;
- Защита от снятия компонента с производства.



Как с нами связаться

Телефон: 8 (812) 309 58 32 (многоканальный)

Факс: 8 (812) 320-02-42

Электронная почта: org@eplast1.ru

Адрес: 198099, г. Санкт-Петербург, ул. Калинина, дом 2, корпус 4, литера А.