



LUXEON CoB Core Range (Gen 2)

Uniform, high-efficacy and easy-to-design array

The second generation of LUXEON CoB represents a new breakthrough in efficacy for arrays. It has 10% higher efficiency and 10% higher lumen output at the same drive currents as existing LUXEON CoB. Due to its small Light Emitting Surface (LES) and industry-leading thermal resistance, LUXEON CoB is easy to work with, enabling simplified and less expensive luminaire designs. LUXEON CoBs are hot-tested at 85°C—real world operating conditions—which means additional testing can be minimized. LUXEON CoB LEDs are available in 3-step MacAdam ellipse, ensuring uniform optical performance in a wide range of applications.



FEATURES AND BENEFITS

Highest flux densities with industry's smallest LES

3-step MacAdam ellipse color definition: *Freedom from Binning* for color consistency from luminaire to luminaire

Up to 4x lower thermal resistance than competition, enabling smaller heat sinks and higher lumens

Supported by a comprehensive optical, mechanical and electrical ecosystem

PRIMARY APPLICATIONS

Architectural

Downlights

High Bay & Low Bay

Lamps

Outdoor

Specialty Lighting

Spotlights

Revision History

Each instance in the revision history table reflects a change to this document from its previous version. For more details, refer to the corresponding sections or links in the table below. For older revisions not listed on the page, please contact your local Lumileds representative.

DATE	DESCRIPTION
February 18, 2016	Added the following parts to LUXEON CoB 1202s: 90CRI (2200K, 2700K, 3000K, 3500K, 4000K)

Table of Contents

General Product Information	2
Product Test Conditions	2
Part Number Nomenclature	2
Lumen Maintenance	2
Environmental Compliance	2
Performance Characteristics	3
Product Selection Guide	3
Optical Characteristics	7
Electrical and Thermal Characteristics	7
Absolute Maximum Ratings	7
Characteristic Curves	8
Spectral Power Distribution Characteristics	8
Light Output Characteristics	9
Forward Current Characteristics	13
Radiation Pattern Characteristics	17
Color Bin Definition	18
Mechanical Dimensions	19
Package and Labeling Information	23
Total Units per Tube	23
Tube Dimensions	23
Tube Label	24
Inner Box	25
Outer Box	26

General Product Information

Product Test Conditions

LUXEON CoB Core Range (Gen 2) LEDs are tested and binned with a DC drive current specified below at a junction temperature, T_j , of 85°C:

200mA	-	LUXEON CoB 1202s
200mA	-	LUXEON CoB 1202
300mA	-	LUXEON CoB 1203
450mA	-	LUXEON CoB 1204
600mA	-	LUXEON CoB 1205
900mA	-	LUXEON CoB 1208
1200mA	-	LUXEON CoB 1211
1600mA	-	LUXEON CoB 1216

Part Number Nomenclature

Part numbers for LUXEON CoB Core Range (Gen 2) follow the convention below:

L 2 C 2 - **A A B B C C C C E D D F F**

Where:

- A A** - designates nominal CCT (22=2200K, 27=2700K, 30=3000K, 35=3500K, 40=4000K, 50=5000K, 57=5700K)
- B B** - designates minimum CRI (70=70CRI, 80=80CRI, 90=90CRI)
- C C C C** - designates product configuration (example: 1202, 1203, 1204, 1205, 1208, 1211, 1216)
- D D** - designates light emitting surface (LES) size (06=6mm, 09=9mm, 13=13mm, 15=15mm, 19=19mm, 23=23mm)
- F F** - designates options for product specification

Therefore, the following part number is used for a LUXEON CoB Core Range (Gen 2) 1203, 3000K 80CRI, 9mm LES:

L 2 C 2 - **3 0 8 0 1 2 0 3 E 0 9 0 0**

Lumen Maintenance

Please contact your local Sales Representative or Lumileds Technical Solutions Manager for more information about the long-term performance of this product.

Environmental Compliance

Lumileds LLC is committed to providing environmentally friendly products to the solid-state lighting market. LUXEON CoB Core Range (Gen 2) is compliant to the European Union directives on the restriction of hazardous substances in electronic equipment, namely the RoHS Directive 2011/65/EU and REACH Regulation (EC) 1907/2006. Lumileds LLC will not intentionally add the following restricted materials to its products: lead, mercury, cadmium, hexavalent chromium, polybrominated biphenyls (PBB) or polybrominated diphenyl ethers (PBDE).

Performance Characteristics

Product Selection Guide

Table 1. Product performance of LUXEON CoB Core Range (Gen 2) at specified test current, $T_j=85^\circ\text{C}$.

PRODUCT	NOMINAL CCT	MINIMUM CRI ^[1, 2, 3]	LUMINOUS FLUX ^[1] (lm)		TYPICAL LUMINOUS EFFICACY (lm/W)	TEST CURRENT (mA)	LES (mm)	PART NUMBER	
			MINIMUM	TYPICAL					
LUXEON CoB 1202s	2200K	80	660	733	105	200	6.5	L2C2-22801202E0600	
	2700K	80	756	840	120	200	6.5	L2C2-27801202E0600	
	3000K	80	788	875	125	200	6.5	L2C2-30801202E0600	
	3500K	80	828	920	131	200	6.5	L2C2-35801202E0600	
	4000K	80	844	938	134	200	6.5	L2C2-40801202E0600	
	5000K	80	860	956	137	200	6.5	L2C2-50801202E0600	
	5700K	80	828	920	131	200	6.5	L2C2-57801202E0600	
	2200K	90	573	636	91	200	6.5	L2C2-22901202E0600	
	2200K	90 ^[4]	539	599	86	200	6.5	L2C2-22951202E0600	
	2700K	90	661	734	105	200	6.5	L2C2-27901202E0600	
	2700K	90 ^[4]	609	677	97	200	6.5	L2C2-27951202E0600	
	3000K	90	675	750	107	200	6.5	L2C2-30901202E0600	
	3000K	90 ^[4]	637	708	101	200	6.5	L2C2-30951202E0600	
	3500K	90	708	786	112	200	6.5	L2C2-35901202E0600	
	3500K	90 ^[4]	662	735	105	200	6.5	L2C2-35951202E0600	
	4000K	90	720	800	114	200	6.5	L2C2-40901202E0600	
	4000K	90 ^[4]	700	778	111	200	6.5	L2C2-40951202E0600	
	LUXEON CoB 1202	3000K	70	924	1027	147	200	9	L2C2-30701202E0900
		3500K	70	924	1027	147	200	9	L2C2-35701202E0900
		4000K	70	982	1092	152	200	9	L2C2-40701202E0900
5000K		70	982	1092	152	200	9	L2C2-50701202E0900	
5700K		70	941	1045	149	200	9	L2C2-57701202E0900	
2200K		80	658	731	104	200	9	L2C2-22801202E0900	
2700K		80	791	879	126	200	9	L2C2-27801202E0900	
3000K		80	833	925	132	200	9	L2C2-30801202E0900	
3500K		80	866	962	137	200	9	L2C2-35801202E0900	
4000K		80	895	994	142	200	9	L2C2-40801202E0900	
5000K		80	899	999	143	200	9	L2C2-50801202E0900	
5700K		80	859	955	134	200	9	L2C2-57801202E0900	
2200K		90	599	666	95	200	9	L2C2-22901202E0900	
2700K		90	691	768	110	200	9	L2C2-27901202E0900	
3000K		90	716	796	114	200	9	L2C2-30901202E0900	
3500K		90	740	822	118	200	9	L2C2-35901202E0900	
4000K		90	774	860	123	200	9	L2C2-40901202E0900	

Table 1 continued on next page.

1. Lumileds maintains a tolerance of ± 2 on CRI and $\pm 6.5\%$ on luminous flux measurements.
2. Typical CRI is approximately 2 points higher than the minimum CRI specified, but this is not guaranteed.
3. R9 value of 90CRI products is >50 .
4. Typical CRI is 97.

Table 1. Product performance of LUXEON CoB Core Range (Gen 2) at specified test current, T_j=85°C (continued).

PRODUCT	NOMINAL CCT	MINIMUM CRI ^[1, 2, 3]	LUMINOUS FLUX ^[1] (lm)		TYPICAL LUMINOUS EFFICACY (lm/W)	TEST CURRENT (mA)	LES (mm)	PART NUMBER	
			MINIMUM	TYPICAL					
LUXEON CoB 1203	3000K	70	1332	1499	143	300	9	L2C2-30701203E0900	
	3500K	70	1332	1499	143	300	9	L2C2-35701203E0900	
	4000K	70	1416	1593	148	300	9	L2C2-40701203E0900	
	5000K	70	1416	1593	148	300	9	L2C2-50701203E0900	
	5700K	70	1356	1526	145	300	9	L2C2-57701203E0900	
	2200K	80	948	1067	102	300	9	L2C2-22801203E0900	
	2700K	80	1140	1283	122	300	9	L2C2-27801203E0900	
	3000K	80	1200	1350	129	300	9	L2C2-30801203E0900	
	3500K	80	1248	1404	134	300	9	L2C2-35801203E0900	
	4000K	80	1290	1451	138	300	9	L2C2-40801203E0900	
	5000K	80	1296	1458	139	300	9	L2C2-50801203E0900	
	5700K	80	1264	1404	134	300	9	L2C2-57801203E0900	
	2200K	90	864	972	93	300	9	L2C2-22901203E0900	
	2700K	90	996	1121	107	300	9	L2C2-27901203E0900	
	3000K	90	1032	1161	111	300	9	L2C2-30901203E0900	
	3500K	90	1067	1200	114	300	9	L2C2-35901203E0900	
	4000K	90	1116	1256	120	300	9	L2C2-40901203E0900	
	LUXEON CoB 1204	3000K	70	1998	2248	143	450	13	L2C2-30701204E1300
		3500K	70	1998	2248	143	450	13	L2C2-35701204E1300
		4000K	70	2124	2390	148	450	13	L2C2-40701204E1300
5000K		70	2124	2390	148	450	13	L2C2-50701204E1300	
5700K		70	2034	2288	145	450	13	L2C2-57701204E1300	
2200K		80	1422	1600	102	450	13	L2C2-22801204E1300	
2700K		80	1710	1924	122	450	13	L2C2-27801204E1300	
3000K		80	1800	2025	129	450	13	L2C2-30801204E1300	
3500K		80	1872	2106	134	450	13	L2C2-35801204E1300	
4000K		80	1935	2177	138	450	13	L2C2-40801204E1300	
5000K		80	1944	2187	139	450	13	L2C2-50801204E1300	
5700K		80	1971	2190	134	450	13	L2C2-57801204E1300	
2200K		90	1296	1458	93	450	13	L2C2-22901204E1300	
2700K		90	1494	1681	107	450	13	L2C2-27901204E1300	
3000K		90	1548	1742	111	450	13	L2C2-30901204E1300	
3500K		90	1600	1800	114	450	13	L2C2-35901204E1300	
4000K		90	1674	1883	120	450	13	L2C2-40901204E1300	

Table 1 continued on next page.

1. Lumileds maintains a tolerance of ±2 on CRI and ±6.5% on luminous flux measurements.
2. Typical CRI is approximately 2 points higher than the minimum CRI specified, but this is not guaranteed.
3. R9 value of 90CRI products is >50.

Table 1. Product performance of LUXEON CoB Core Range (Gen 2) at specified test current, T_j=85°C (continued).

PRODUCT	NOMINAL CCT	MINIMUM CRI ^[1, 2, 3]	LUMINOUS FLUX ^[1] (lm)		TYPICAL LUMINOUS EFFICACY (lm/W)	TEST CURRENT (mA)	LES (mm)	PART NUMBER	
			MINIMUM	TYPICAL					
LUXEON CoB 1205	3000K	70	2720	2997	143	600	13	L2C2-30701205E1300	
	3500K	70	2720	2997	143	600	13	L2C2-35701205E1300	
	4000K	70	2891	3186	148	600	13	L2C2-40701205E1300	
	5000K	70	2891	3186	148	600	13	L2C2-50701205E1300	
	5700K	70	2769	3051	145	600	13	L2C2-57701205E1300	
	2200K	80	1936	2133	102	600	13	L2C2-22801205E1300	
	2700K	80	2328	2565	122	600	13	L2C2-27801205E1300	
	3000K	80	2450	2700	129	600	13	L2C2-30801205E1300	
	3500K	80	2548	2808	134	600	13	L2C2-35801205E1300	
	4000K	80	2634	2903	138	600	13	L2C2-40801205E1300	
	5000K	80	2646	2916	139	600	13	L2C2-50801205E1300	
	5700K	80	2527	2808	134	600	13	L2C2-57801205E1300	
	2200K	90	1764	1944	93	600	13	L2C2-22901205E1300	
	2700K	90	2034	2241	107	600	13	L2C2-27901205E1300	
	3000K	90	2107	2322	111	600	13	L2C2-30901205E1300	
	3500K	90	2178	2400	114	600	13	L2C2-35901205E1300	
	4000K	90	2279	2511	120	600	13	L2C2-40901205E1300	
	LUXEON CoB 1208	3000K	70	4024	4496	143	900	15	L2C2-30701208E1500
		3500K	70	4024	4496	143	900	15	L2C2-35701208E1500
		4000K	70	4278	4779	148	900	15	L2C2-40701208E1500
5000K		70	4278	4779	148	900	15	L2C2-50701208E1500	
5700K		70	4096	4577	145	900	15	L2C2-57701208E1500	
2200K		80	2864	3200	102	900	15	L2C2-22801208E1500	
2700K		80	3444	3848	122	900	15	L2C2-27801208E1500	
3000K		80	3625	4050	129	900	15	L2C2-30801208E1500	
3500K		80	3770	4212	134	900	15	L2C2-35801208E1500	
4000K		80	3897	4354	138	900	15	L2C2-40801208E1500	
5000K		80	3915	4374	139	900	15	L2C2-50801208E1500	
5700K		80	3791	4212	134	900	15	L2C2-57801208E1500	
2200K		90	2610	2916	93	900	15	L2C2-22901208E1500	
2700K		90	3009	3362	107	900	15	L2C2-27901208E1500	
3000K		90	3118	3483	111	900	15	L2C2-30901208E1500	
3500K		90	3223	3600	114	900	15	L2C2-35901208E1500	
4000K		90	3371	3767	120	900	15	L2C2-40901208E1500	

Table 1 continued on next page.

1. Lumileds maintains a tolerance of ±2 on CRI and ±6.5% on luminous flux measurements.
2. Typical CRI is approximately 2 points higher than the minimum CRI specified, but this is not guaranteed.
3. R9 value of 90CRI products is >50.

Table 1. Product performance of LUXEON CoB Core Range (Gen 2) at specified test current, $T_j=85^{\circ}\text{C}$ (continued).

PRODUCT	NOMINAL CCT	MINIMUM CRI ^[1, 2, 3]	LUMINOUS FLUX ^[1] (lm)		TYPICAL LUMINOUS EFFICACY (lm/W)	TEST CURRENT (mA)	LES (mm)	PART NUMBER
			MINIMUM	TYPICAL				
LUXEON CoB 1211	3000K	70	5550	5994	143	1200	19	L2C2-30701211E1900
	3500K	70	5550	5994	143	1200	19	L2C2-35701211E1900
	4000K	70	5900	6372	148	1200	19	L2C2-40701211E1900
	5000K	70	5900	6372	148	1200	19	L2C2-50701211E1900
	5700K	70	5650	6102	145	1200	19	L2C2-57701211E1900
	2200K	80	3950	4266	102	1200	19	L2C2-22801211E1900
	2700K	80	4750	5130	122	1200	19	L2C2-27801211E1900
	3000K	80	5000	5400	129	1200	19	L2C2-30801211E1900
	3500K	80	5200	5616	134	1200	19	L2C2-35801211E1900
	4000K	80	5375	5805	138	1200	19	L2C2-40801211E1900
	5000K	80	5400	5832	139	1200	19	L2C2-50801211E1900
	5700K	80	5054	5616	134	1200	19	L2C2-57801211E1900
	2200K	90	3600	3888	93	1200	19	L2C2-22901211E1900
	2700K	90	4150	4482	107	1200	19	L2C2-27901211E1900
	3000K	90	4300	4644	111	1200	19	L2C2-30901211E1900
	3500K	90	4445	4801	114	1200	19	L2C2-35901211E1900
	4000K	90	4650	5022	120	1200	19	L2C2-40901211E1900
	LUXEON CoB 1216	3000K	70	7229	8032	143	1600	23
3500K		70	7229	8032	143	1600	23	L2C2-35701216E2300
4000K		70	7684	8538	152	1600	23	L2C2-40701216E2300
5000K		70	7684	8538	152	1600	23	L2C2-50701216E2300
5700K		70	7359	8177	146	1600	23	L2C2-57701216E2300
2200K		80	5144	5716	102	1600	23	L2C2-22801216E2300
2700K		80	6187	6874	123	1600	23	L2C2-27801216E2300
3000K		80	6512	7236	129	1600	23	L2C2-30801216E2300
3500K		80	6773	7525	134	1600	23	L2C2-35801216E2300
4000K		80	7002	7780	139	1600	23	L2C2-40801216E2300
5000K		80	7034	7815	140	1600	23	L2C2-50801216E2300
5700K		80	6773	7525	134	1600	23	L2C2-57801216E2300
2200K		90	4689	5210	93	1600	23	L2C2-22901216E2300
2700K		90	5405	6006	107	1600	23	L2C2-27901216E2300
3000K		90	5601	6223	111	1600	23	L2C2-30901216E2300
3500K		90	5790	6433	115	1600	23	L2C2-35901216E2300
4000K		90	6056	6729	120	1600	23	L2C2-40901216E2300

Notes for Table 1:

1. Lumileds maintains a tolerance of ± 2 on CRI and $\pm 6.5\%$ on luminous flux measurements.
2. Typical CRI is approximately 2 points higher than the minimum CRI specified, but this is not guaranteed.
3. R9 value of 90CRI products is >50 .

Optical Characteristics

Table 2. Optical characteristics for LUXEON CoB Core Range (Gen 2) at specified test current, $T_j=85^\circ\text{C}$.

PART NUMBER	TYPICAL TOTAL INCLUDED ANGLE ^[1]	TYPICAL VIEWING ANGLE ^[2]
L2C2-xxxx12xxExx00	135°	115°

Notes for Table 2:

1. Total angle at which 90% of total luminous flux is captured.
2. Viewing angle is the off axis angle from the LED centerline where the luminous intensity is ½ of the peak value.

Electrical and Thermal Characteristics

Table 3. Electrical and thermal characteristics for LUXEON CoB Core Range (Gen 2) at specified test current, $T_j=85^\circ\text{C}$.

PART NUMBER	FORWARD VOLTAGE ^[1] (V)			TYPICAL TEMPERATURE COEFFICIENT OF FORWARD VOLTAGE ^[2] (mV/°C)	TYPICAL THERMAL RESISTANCE JUNCTION TO SOLDER PAD ^[3] (°C/W)
	MINIMUM	TYPICAL	MAXIMUM		
L2C2-XXXX1202E0600	32.5	34.5	37.5	-16	0.98
L2C2-xxxx1202E0900	32.5	34.5	37.5	-16	0.98
L2C2-xxxx1203E0900	32.5	34.5	37.5	-16	0.70
L2C2-xxxx1204E1300	32.5	35.0	37.5	-16	0.55
L2C2-xxxx1205E1300	32.5	35.0	37.5	-16	0.51
L2C2-xxxx1208E1500	32.5	35.0	37.5	-16	0.29
L2C2-xxxx1211E1900	32.5	35.0	37.5	-16	0.23
L2C2-xxxx1216E2300	32.5	35.0	37.5	-16	0.14

Notes for Table 3:

1. Lumileds maintains a tolerance of $\pm 2\%$ on forward voltage measurements.
2. Measured between 25°C and 85°C.
3. Thermal resistance is measured between junction and the bottom of the LUXEON CoB substrate.

Absolute Maximum Ratings

Table 4. Absolute maximum ratings for LUXEON CoB Core Range (Gen 2).

PARAMETER	MAXIMUM PERFORMANCE
DC Forward Current ^[1,2]	2x test current
LED Junction Temperature ^[1] (DC & Pulse)	125°C
ESD Sensitivity (ANSI/ESDA/JEDEC JS-001-2012)	Class 3B
Operating Case Temperature ^[1]	-40°C to 105°C
LED Storage Temperature	-40°C to 120°C
Allowable Reflow Cycles	3
Reverse Voltage (V_{reverse})	LUXEON LEDs are not designed to be driven in reverse bias

Notes for Table 4:

1. Proper current derating must be observed to maintain the junction temperature below the maximum allowable junction temperature.
2. Residual periodic variations due to power conversion from alternating current (AC) to direct current (DC), also called "ripple," are acceptable if the following conditions are met:
 - The frequency of the ripple current is 100Hz or higher
 - The average current for each cycle does not exceed the maximum allowable DC forward current
 - The maximum amplitude of the ripple does not exceed 20% of the maximum allowable DC forward current

Characteristic Curves

Spectral Power Distribution Characteristics

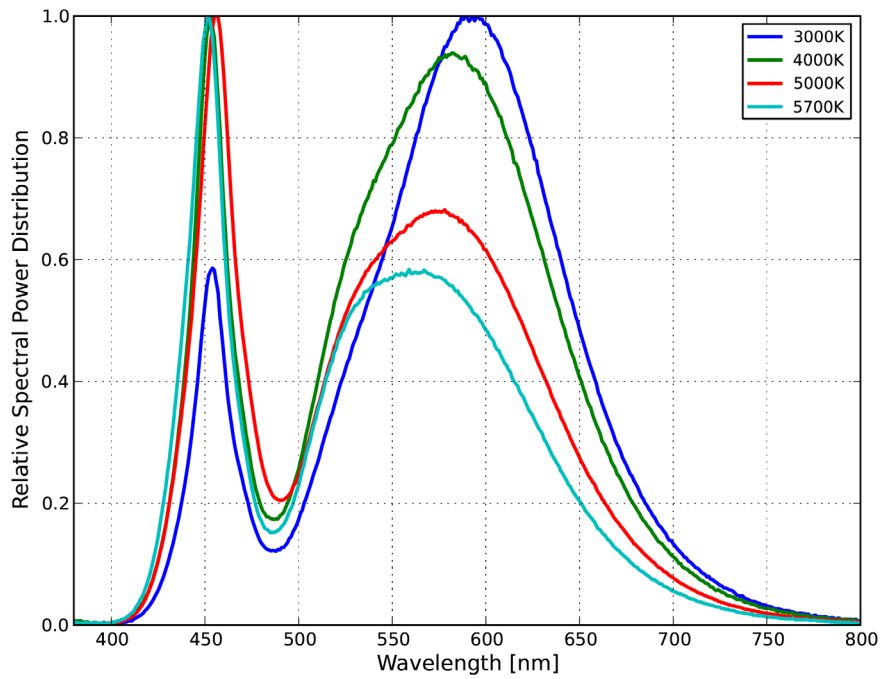

Figure 1a: Typical normalized power vs. wavelength for L2C2-xx70xxxxExx00 at specified test current, $T_j=85^{\circ}\text{C}$.

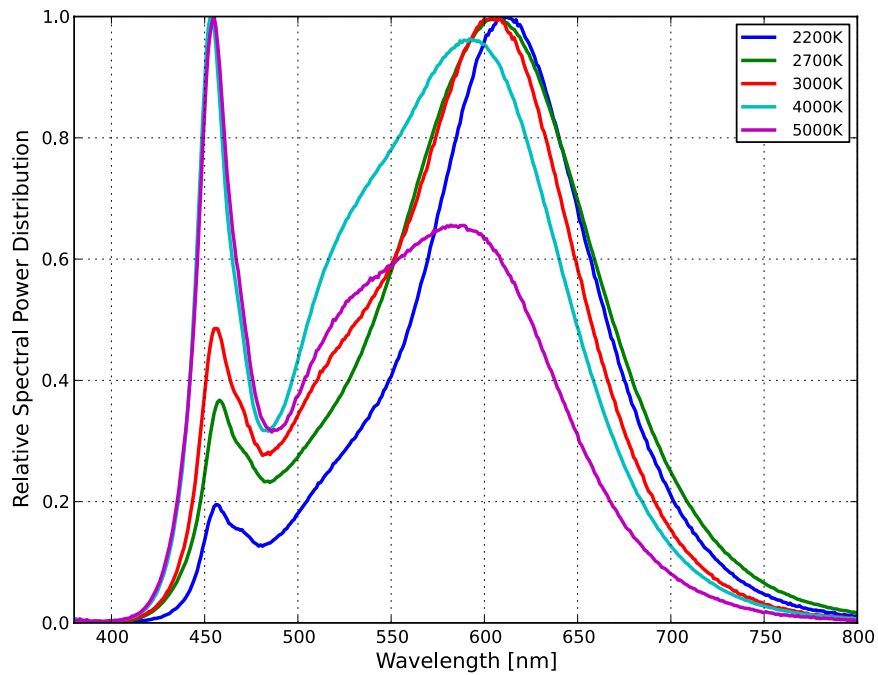

Figure 1b: Typical normalized power vs. wavelength for L2C2-xx80xxxxExx00 at specified test current, $T_j=85^{\circ}\text{C}$.

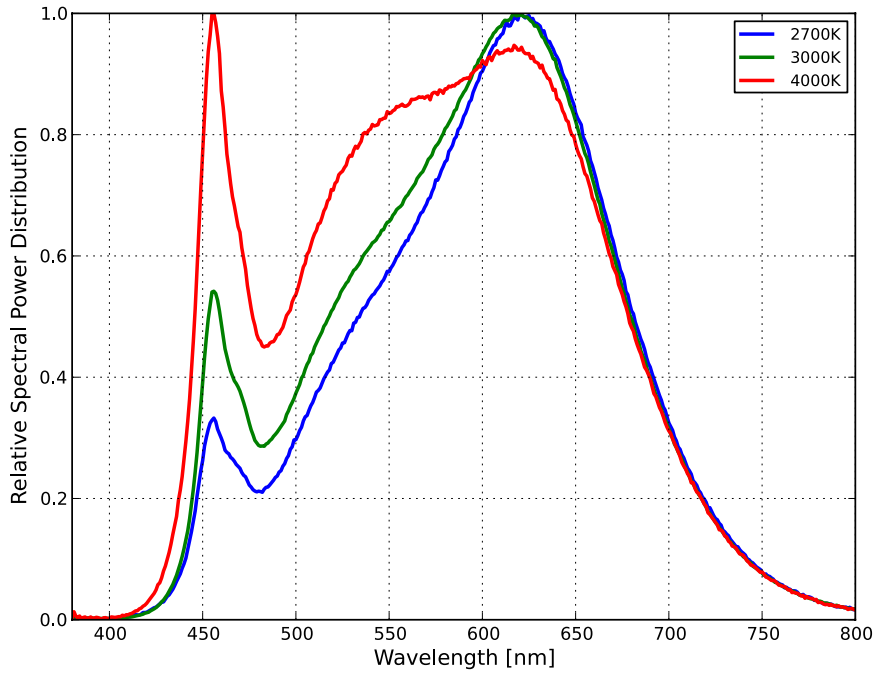

Figure 1c: Typical normalized power vs. wavelength for L2C2-xx90xxxxExx00 at specified test current, $T_j=85^\circ\text{C}$.

Light Output Characteristics

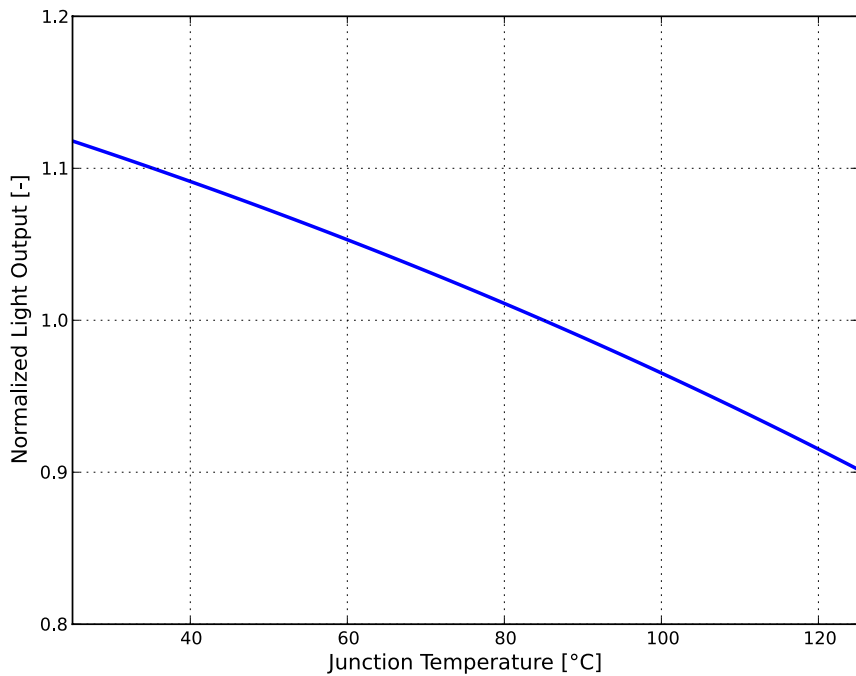

Figure 2: Typical normalized light output vs. junction temperature for L2C2-xxxxxxxExx00 at specified test current.

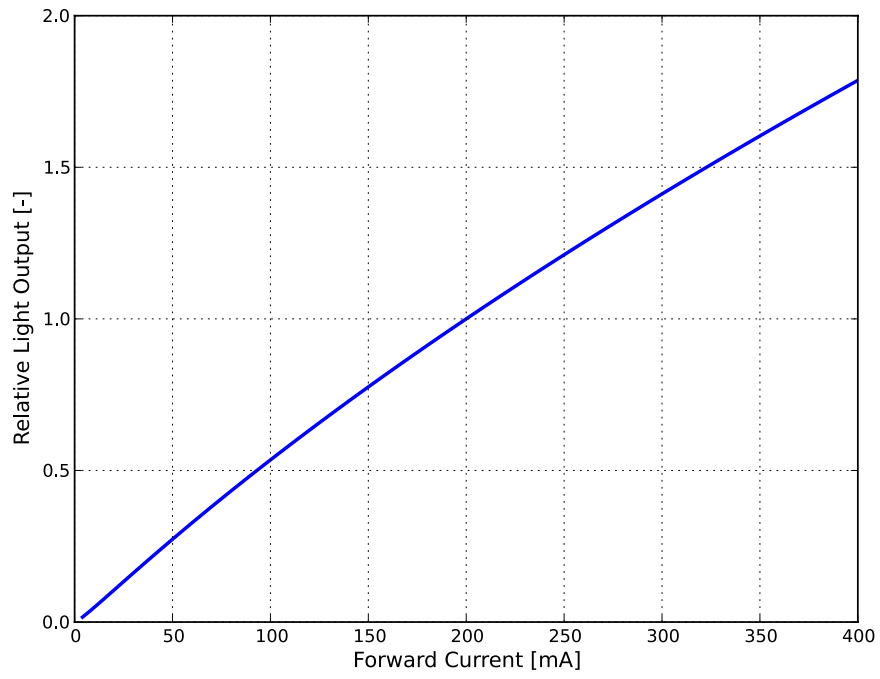

Figure 3a: Typical normalized light output vs. forward current for L2C2-XXXX1202E0600 and L2C2-xxxx1202E0900 at $T_j=85^\circ\text{C}$.

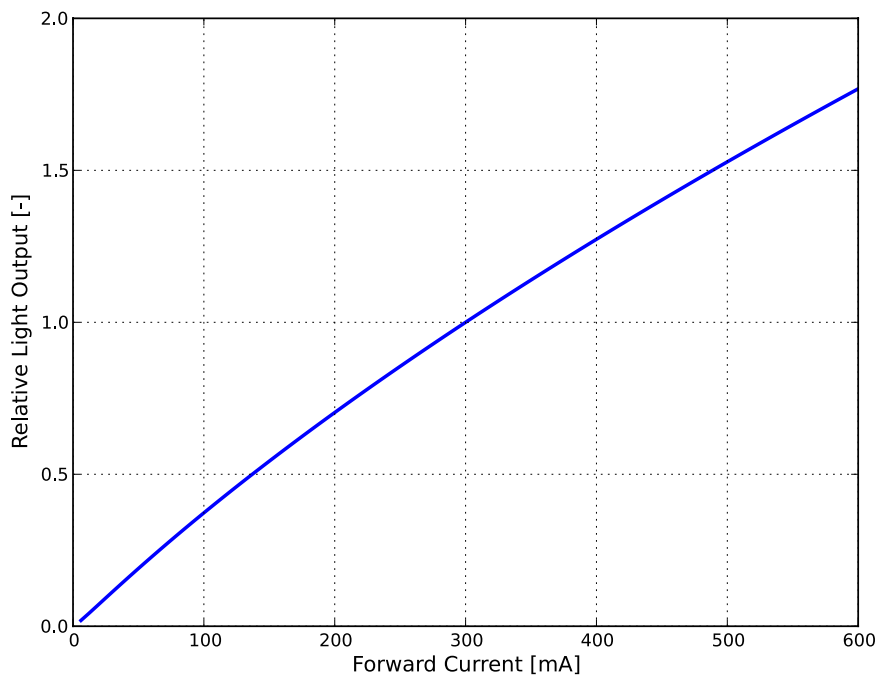

Figure 3b: Typical normalized light output vs. forward current for L2C2-xxxx1203E0900 at $T_j=85^\circ\text{C}$.

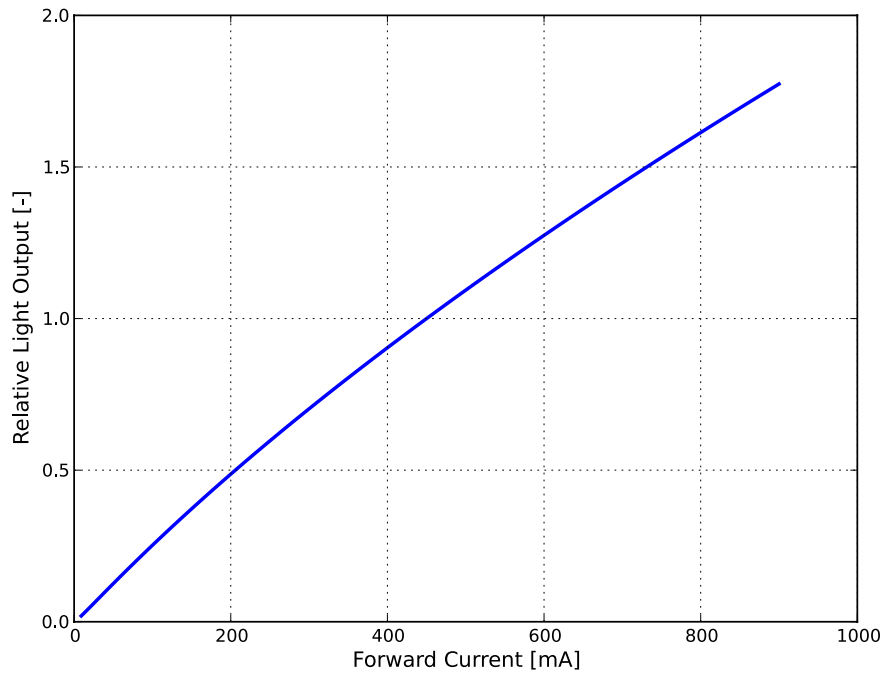

Figure 3c: Typical normalized light output vs. forward current for L2C2-xxxx1204E1300 at $T_j=85^\circ\text{C}$.

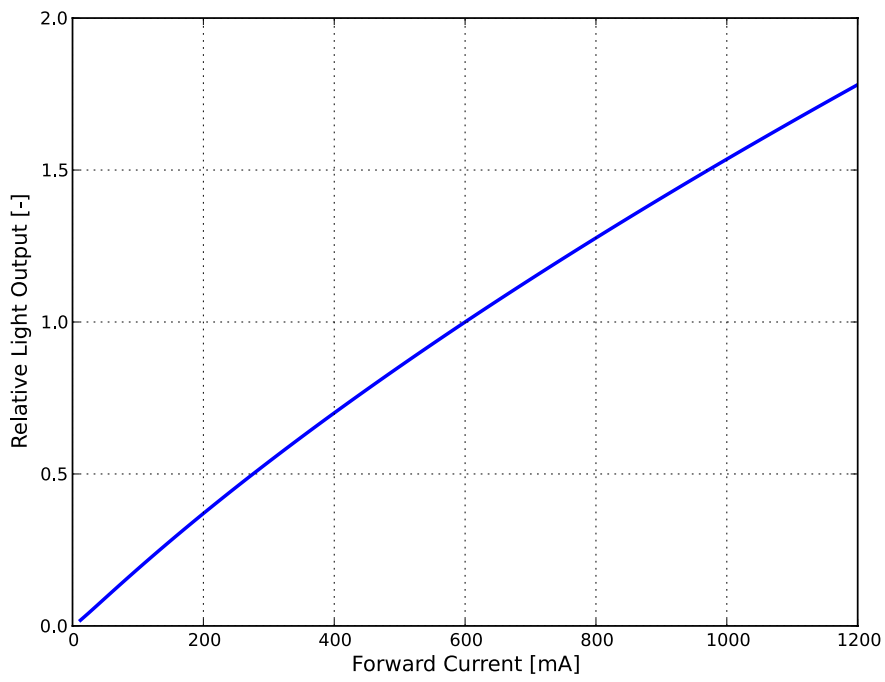

Figure 3d: Typical normalized light output vs. forward current for L2C2-xxxx1205E1300 at $T_j=85^\circ\text{C}$.

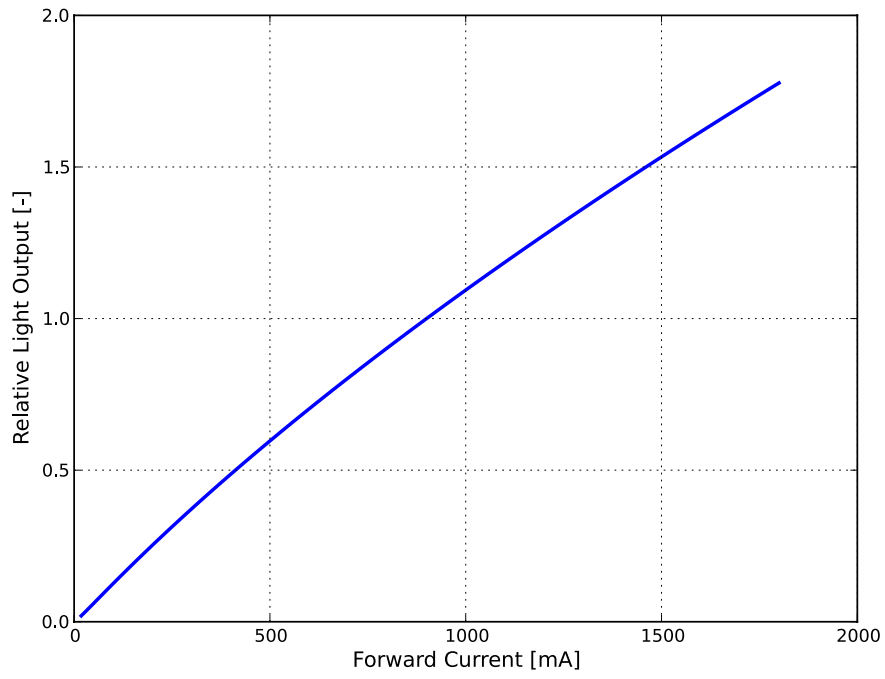

Figure 3e: Typical normalized light output vs. forward current for L2C2-xxxx1208E1500 at $T_j=85^\circ\text{C}$.

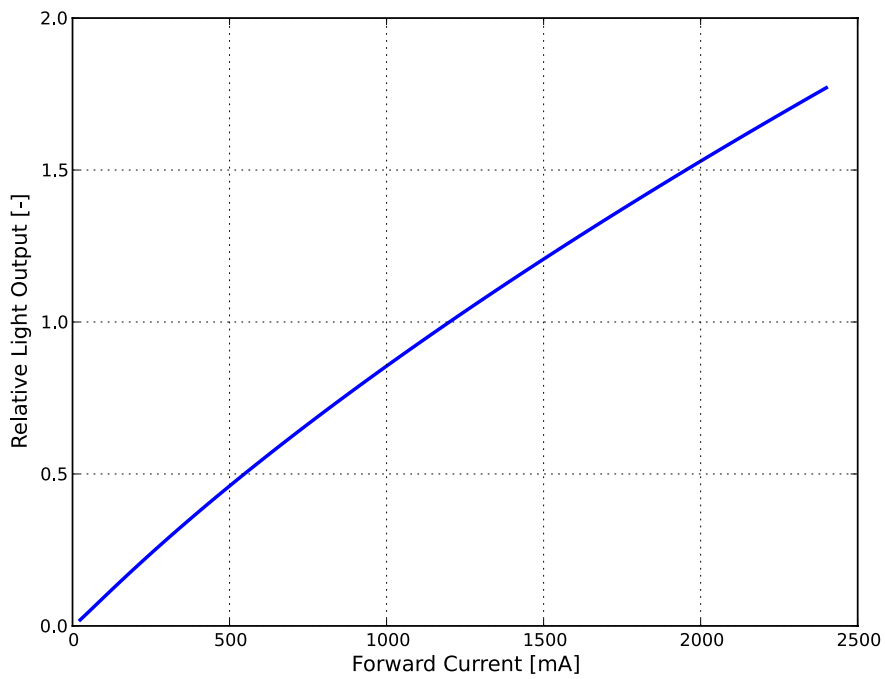

Figure 3f: Typical normalized light output vs. forward current for L2C2-xxxx1211E1900 at $T_j=85^\circ\text{C}$.

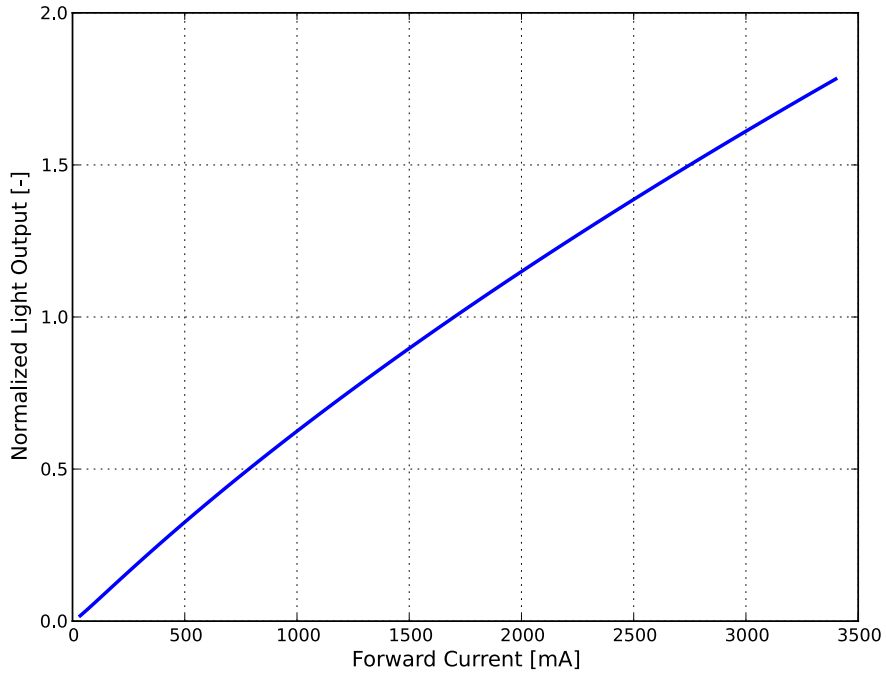

Figure 3g: Typical normalized light output vs. forward current for L2C2-xxxx1216E2300 at $T_j=85^\circ\text{C}$.

Forward Current Characteristics

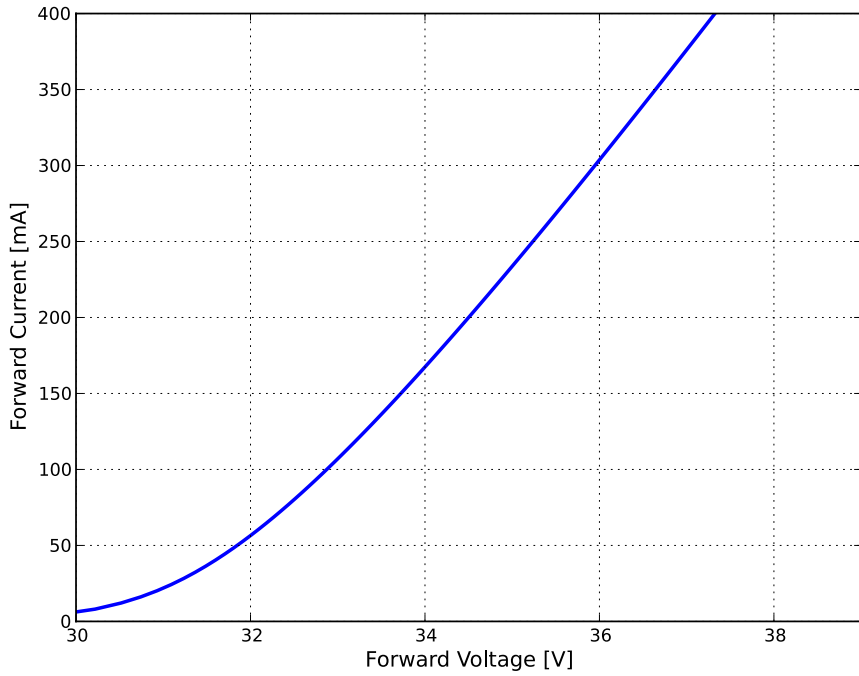

Figure 4a: Typical forward current vs. forward voltage for L2C2-XXXX1202E0600 and L2C2-xxxx1202E0900 at $T_j=85^\circ\text{C}$.

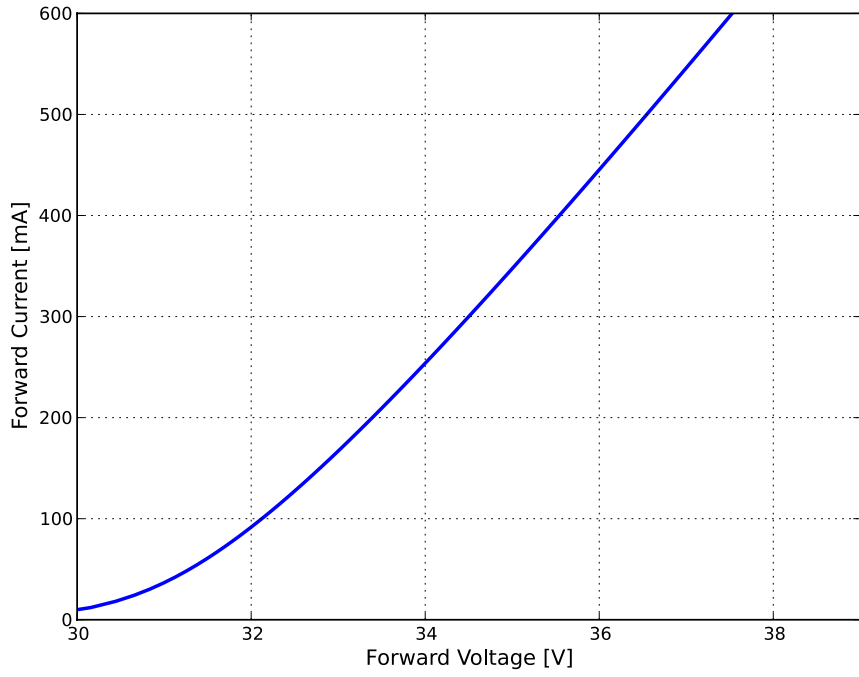

Figure 4b: Typical forward current vs. forward voltage for L2C2-xxxx1203E0900 at $T_j=85^\circ\text{C}$.

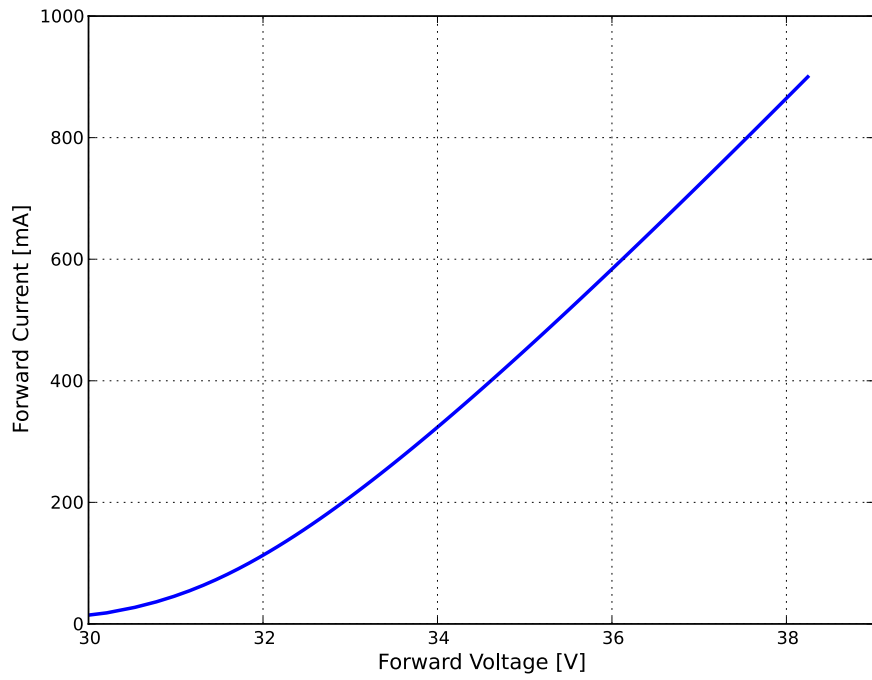

Figure 4c: Typical forward current vs. forward voltage for L2C2-xxxx1204E1300 at $T_j=85^\circ\text{C}$.

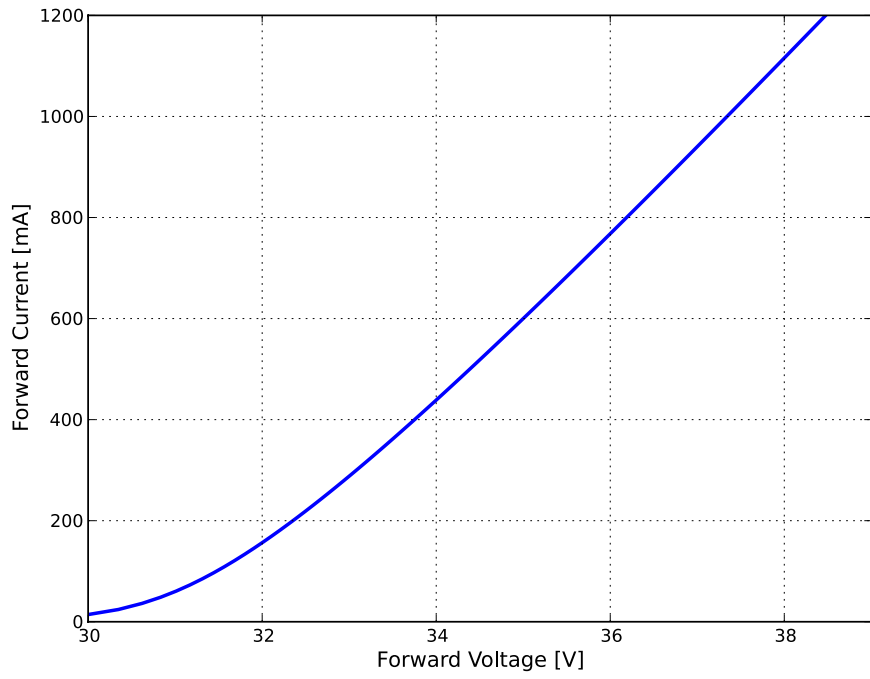

Figure 4d: Typical forward current vs. forward voltage for L2C2-xxxx1205E1300 at $T_j=85^\circ\text{C}$.

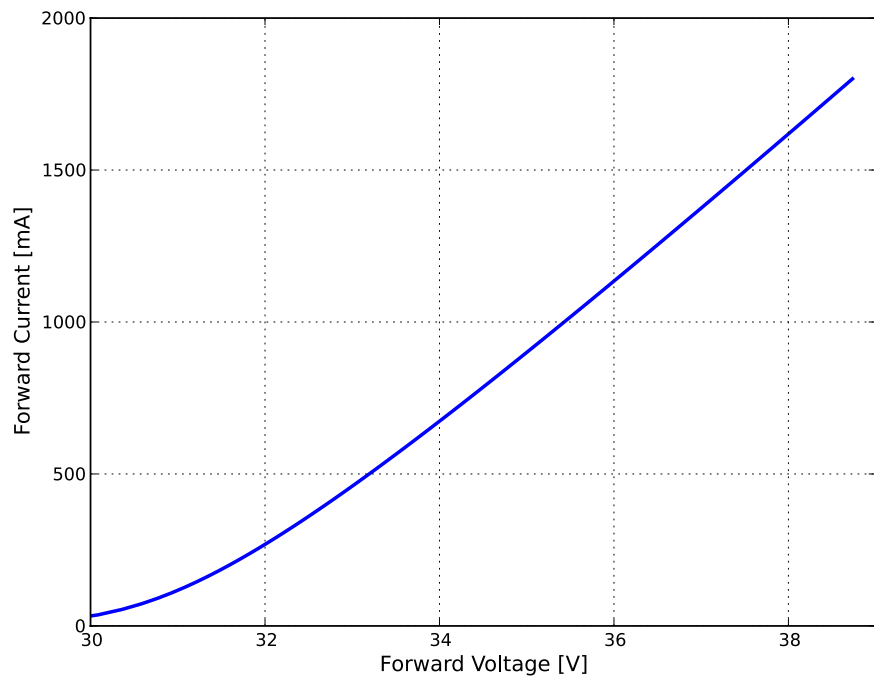

Figure 4e: Typical forward current vs. forward voltage for L2C2-xxxx1208E1500 at $T_j=85^\circ\text{C}$.

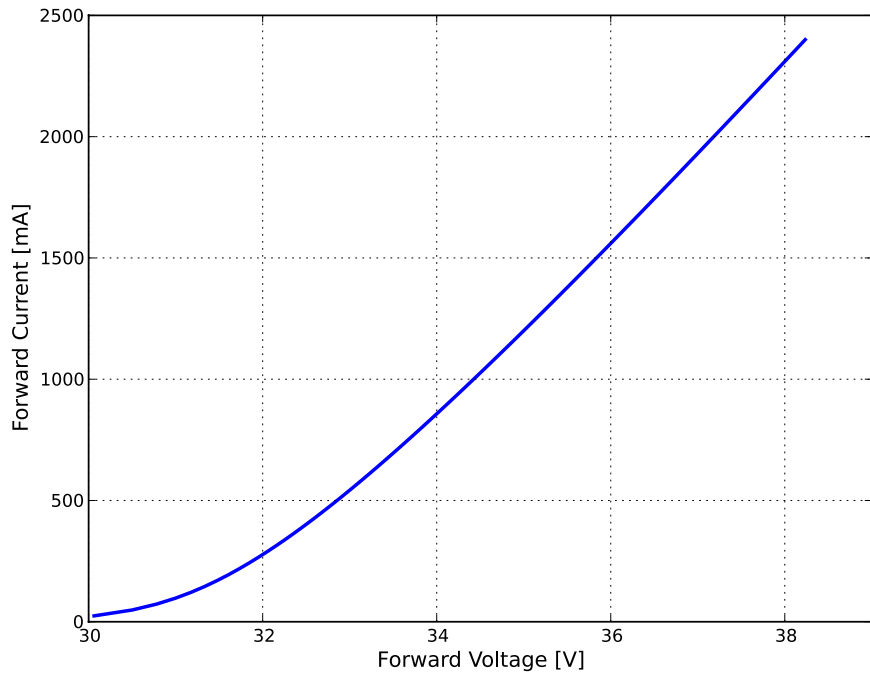

Figure 4f: Typical forward current vs. forward voltage for L2C2-xxxx1211E1900 at $T_j=85^\circ\text{C}$.

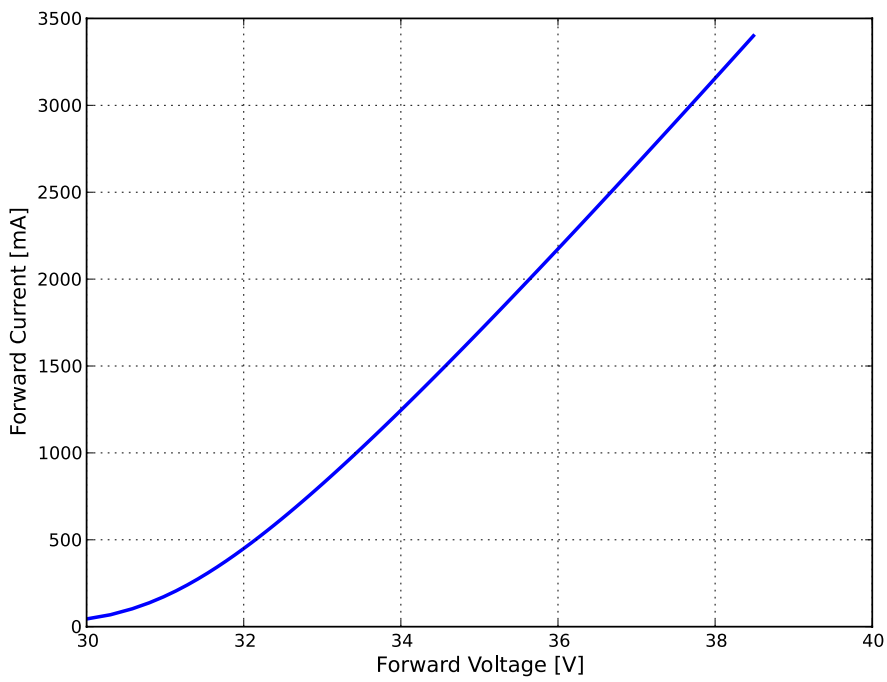

Figure 4g: Typical forward current vs. forward voltage for L2C2-xxxx1216E2300 at $T_j=85^\circ\text{C}$.

Radiation Pattern Characteristics



Figure 5: Typical radiation pattern for L2C2-xxxxxxxExx00 at specified test current, $T_j=85^{\circ}\text{C}$.



Figure 6: Typical polar radiation pattern for L2C2-xxxxxxxExx00 at specified test current, $T_j=85^{\circ}\text{C}$.

Color Bin Definition

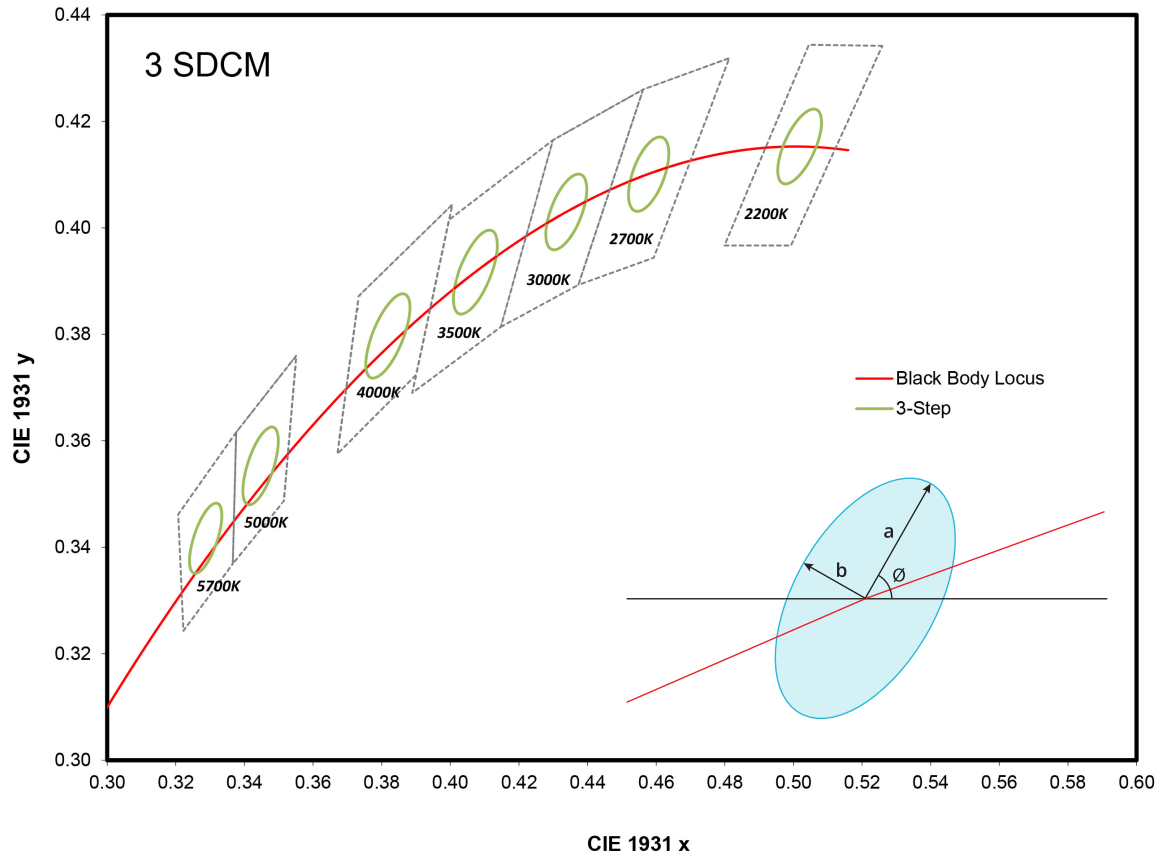

Figure 7: 3-step MacAdam ellipse illustration for Table 5.

Table 5. 3-step MacAdam ellipse color bin definitions for LUXEON CoB Core Range (Gen 2).

NOMINAL CCT	COLOR SPACE	CENTER POINT (cx, cy)	MAJOR AXIS, a	MINOR AXIS, b	ELLIPSE ROTATION ANGLE, θ
2200K	Single 3-step MacAdam ellipse	(0.5020, 0.4155)	0.00862	0.00397	49.30°
2700K	Single 3-step MacAdam ellipse	(0.4578, 0.4101)	0.00810	0.00420	53.70°
3000K	Single 3-step MacAdam ellipse	(0.4338, 0.4030)	0.00834	0.00408	53.20°
3500K	Single 3-step MacAdam ellipse	(0.4073, 0.3917)	0.00927	0.00414	54.00°
4000K	Single 3-step MacAdam ellipse	(0.3818, 0.3797)	0.00939	0.00402	53.70°
5000K	Single 3-step MacAdam ellipse	(0.3447, 0.3553)	0.00822	0.00354	59.60°
5700K	Single 3-step MacAdam ellipse	(0.3287, 0.3417)	0.00745	0.00320	59.09°

Notes for Table 5:

1. Lumileds maintains a tolerance of ± 0.005 on x and y coordinates in the CIE 1931 color space.

Mechanical Dimensions

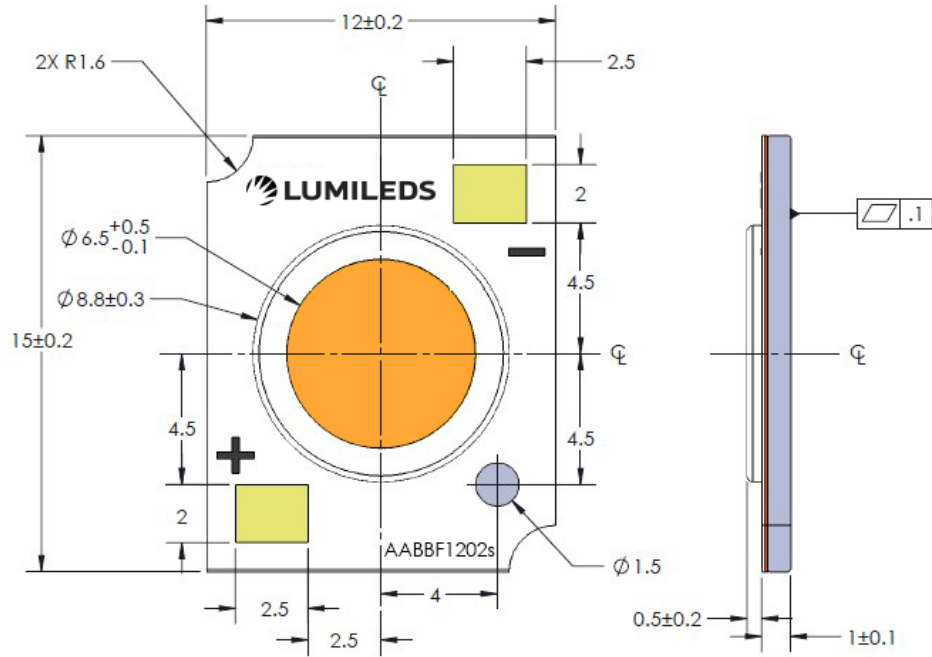

Figure 8a. Mechanical dimensions for L2C2-XXXX1202E0600.

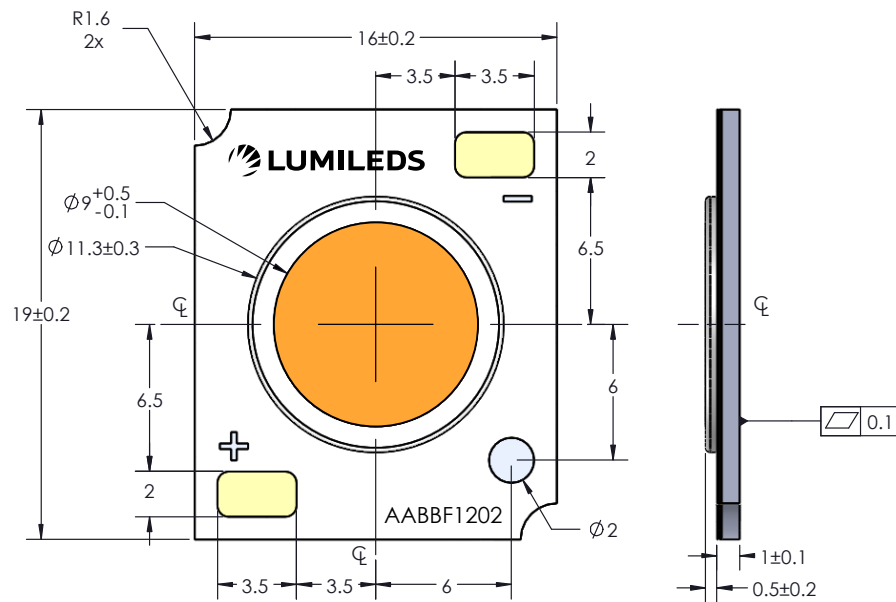

Figure 8b. Mechanical dimensions for L2C2-xxxx1202E0900.

- Notes for Figures 8a and 8b:
1. Drawings not to scale.
 2. All dimensions are in millimeters.

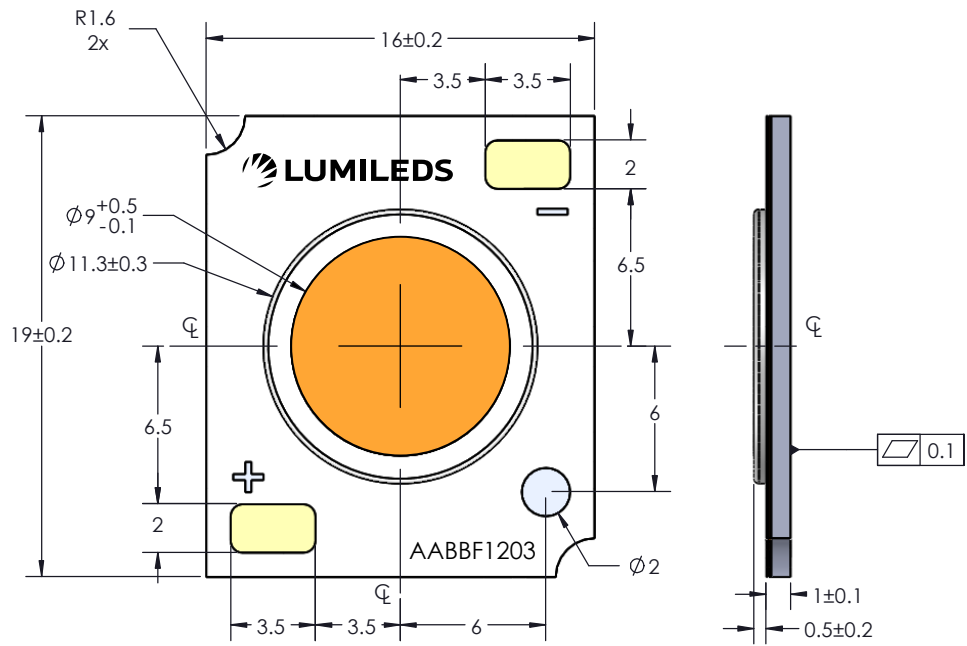

Figure 8c. Mechanical dimensions for L2C2-xxxx1203E0900.

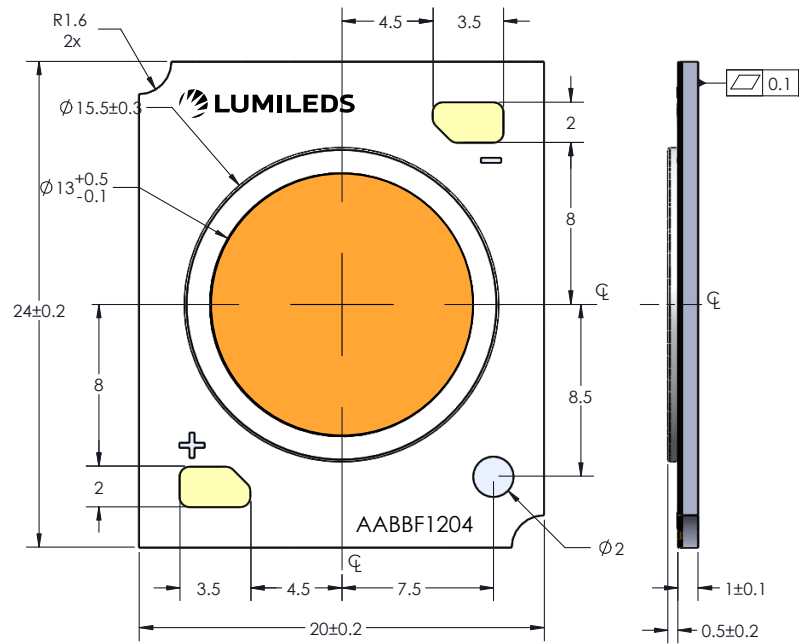

Figure 8d. Mechanical dimensions for L2C2-xxxx1204E1300.

Notes for Figures 8c and 8d:
 1. Drawings not to scale.
 2. All dimensions are in millimeters.

Package and Labeling Information

LUXEON CoB LEDs are packaged in tubes then in a carton box. Each tube contains a specified number of LEDs. The LEDs in each tube come from a single category code, ensuring they are all well-matched for light output, color, and forward voltage. Each tube contains a rubber stopper at one end. The tube label has both alphanumeric and bar code information. The carton boxes have printed information providing part numbers with CAT codes that indicate luminous flux, color and forward voltage bins.

Total Units per Tube

Table 6. Number of LEDs per tube for LUXEON CoB Core Range (Gen2).

PART NUMBER	TOTAL UNITS PER TUBE	TOTAL TUBES PER INNERBOX	TOTAL UNITS PER INNERBOX
L2C2-XXXX1202E0600	20	5	100
L2C2-xxxx1202E0900	20	5	100
L2C2-xxxx1203E0900	20	5	100
L2C2-xxxx1204E1300	20	5	100
L2C2-xxxx1205E1300	20	5	100
L2C2-xxxx1208E1500	20	5	100
L2C2-xxxx1211E1900	10	5	50
L2C2-xxxx1216E2300	10	5	50

Tube Dimensions

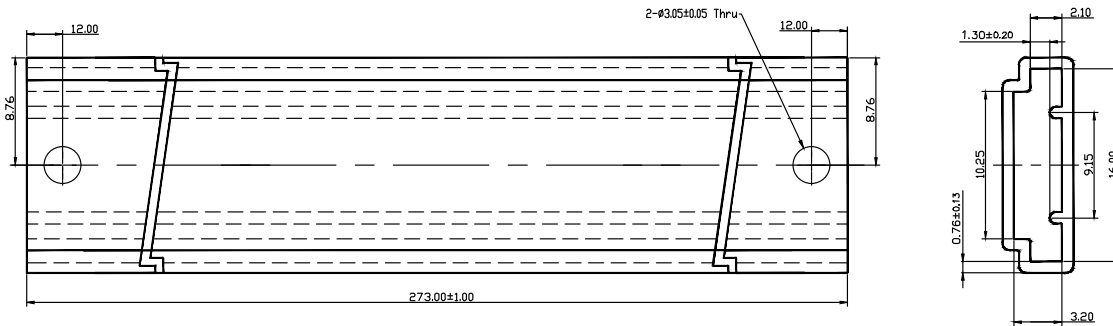

Figure 9a: Tube dimensions for L2C2-XXXX1202E0600.

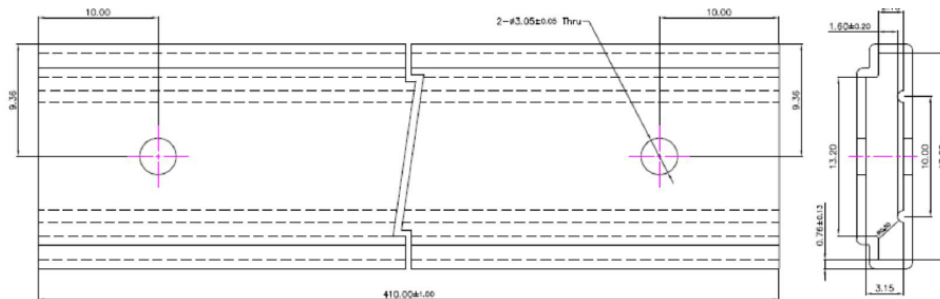

Figure 9b: Tube dimensions for L2C2-xxxxxxx1202E0900.

Notes for Figure 9:

1. Drawings are not to scale.
2. All dimensions are in millimeters.

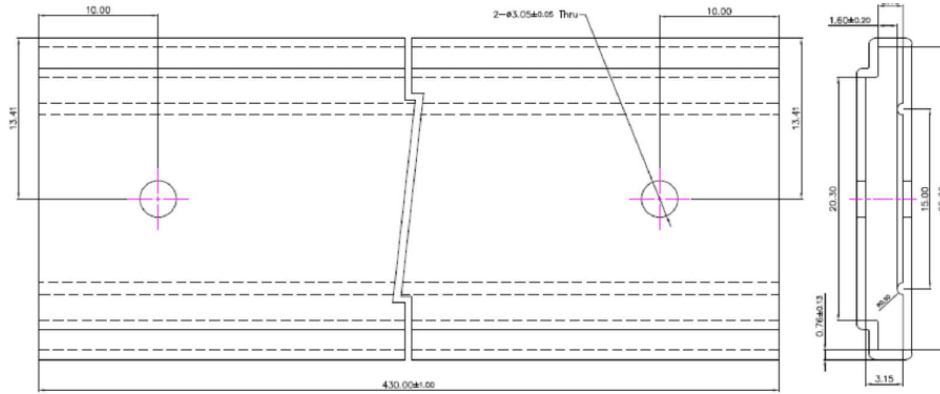

Figure 9c: Tube dimensions for L2C2-xxxx1204E1300, L2C2-xxxx1205E1300 and L2C2-xxxx1208E1500.

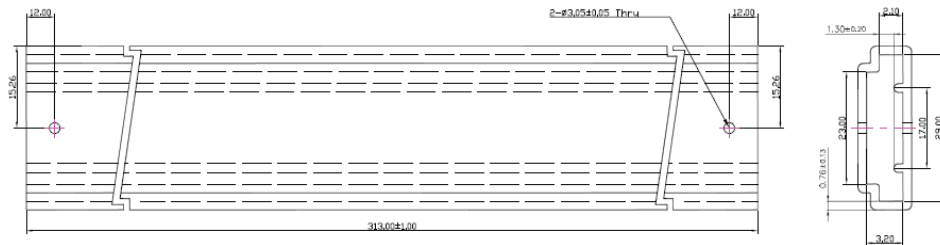

Figure 9d: Tube dimensions for L2C2-xxxx1211E1900.

Notes for Figure 9:

1. Drawings are not to scale.
2. All dimensions are in millimeters.

Tube Label



Figure 10: Example of a tube label.

Table 7. Label information for LUXEON CoB Core Range (Gen2).

ITEM	INFORMATION
(1P) PART #: LHC1-3090-1205 	(1P) Part Number
LOT NO : D1524705.30 	Lot Number
CAT : 3SX 	CAT Code
(Q) QUANTITY : 20 	Tube Quantity
(9D) DTE : 1527 	Manufacturing date code
S/N : 222 	Serial Number

Inner Box

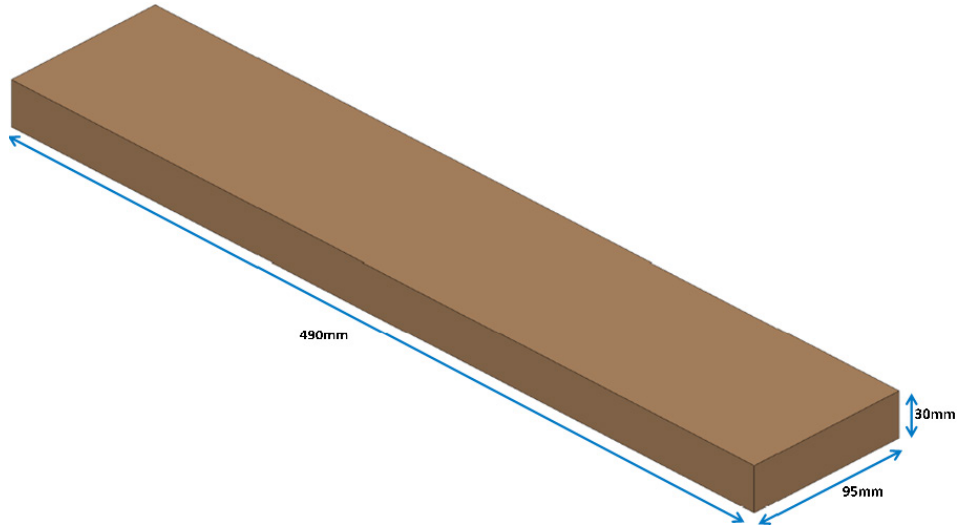

Figure 11: Dimensions for inner box packaging.

Table 8. Inner box information for LUXEON CoB Core Range (Gen2).

BOX TYPE	DIMENSIONS (mm)			AVERAGE WEIGHT (100pcs/box)	AVERAGE WEIGHT (100pcs/box)
	H	L	W		
Inner Box	30	490	95	0.340Kg	0.305Kg



Figure 12: Example of inner box label for LUXEON CoB Core Range (Gen2).

Outer Box

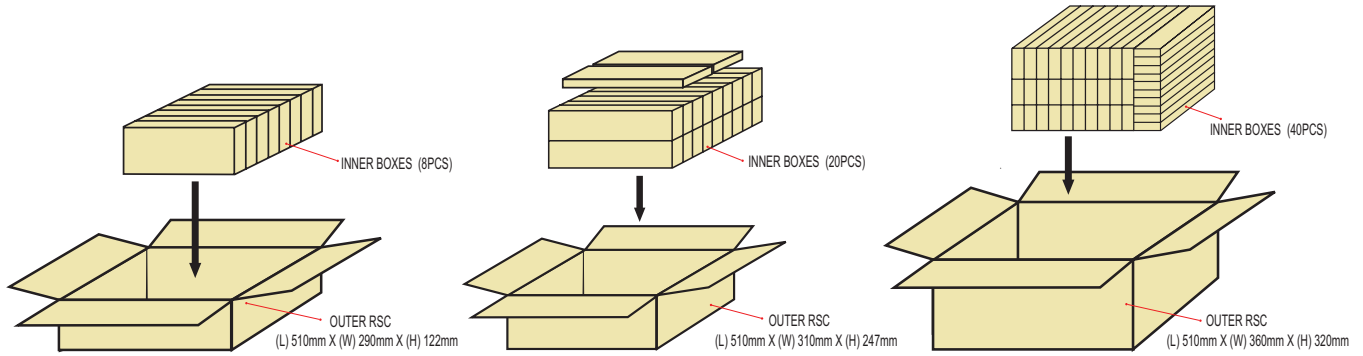

Figure 13. Dimensions for outer box packaging for LUXEON CoB (Gen2).

Table 9. Outer box information for LUXEON CoB Core Range (Gen2).

BOX TYPE	DIMENSIONS (mm)			MAXIMUM INNER BOX PER OUTER BOX	MAXIMUM QUANTITY PER OUTER BOX	AVERAGE WEIGHT (100pcs/box)	AVERAGE WEIGHT (50pcs/box)
	H	L	W				
Outer Box 8	122	510	290	8	800	3.05kg	2.77kg
Outer Box 20	247	510	310	20	2000	7.55kg	6.85kg
Outer Box 40	320	510	360	40	4000	15.10kg	13.70kg



Figure 14. Example of outer box label for LUXEON CoB Core Range (Gen2).

About Lumileds

Lumileds is the global leader in light engine technology. The company develops, manufactures and distributes groundbreaking LEDs and automotive lighting products that shatter the status quo and help customers gain and maintain a competitive edge. With a rich history of industry “firsts,” Lumileds is uniquely positioned to deliver lighting advancements well into the future by maintaining an unwavering focus on quality, innovation and reliability.

To learn more about our portfolio of light engines, visit lumileds.com.



©2016 Lumileds Holding B.V. All rights reserved.
LUXEON is a registered trademark of the Lumileds Holding B.V.
in the United States and other countries.
lumileds.com

Neither Lumileds Holding B.V. nor its affiliates shall be liable for any kind of loss of data or any other damages, direct, indirect or consequential, resulting from the use of the provided information and data. Although Lumileds Holding B.V. and/or its affiliates have attempted to provide the most accurate information and data, the materials and services information and data are provided “as is,” and neither Lumileds Holding B.V. nor its affiliates warrants or guarantees the contents and correctness of the provided information and data. Lumileds Holding B.V. and its affiliates reserve the right to make changes without notice. You as user agree to this disclaimer and user agreement with the download or use of the provided materials, information and data.



Компания «ЭлектроПласт» предлагает заключение долгосрочных отношений при поставках импортных электронных компонентов на взаимовыгодных условиях!

Наши преимущества:

- Оперативные поставки широкого спектра электронных компонентов отечественного и импортного производства напрямую от производителей и с крупнейших мировых складов;
- Поставка более 17-ти миллионов наименований электронных компонентов;
- Поставка сложных, дефицитных, либо снятых с производства позиций;
- Оперативные сроки поставки под заказ (от 5 рабочих дней);
- Экспресс доставка в любую точку России;
- Техническая поддержка проекта, помощь в подборе аналогов, поставка прототипов;
- Система менеджмента качества сертифицирована по Международному стандарту ISO 9001;
- Лицензия ФСБ на осуществление работ с использованием сведений, составляющих государственную тайну;
- Поставка специализированных компонентов (Xilinx, Altera, Analog Devices, Intersil, Interpoint, Microsemi, Aeroflex, Peregrine, Syfer, Eurofarad, Texas Instrument, Miteq, Cobham, E2V, MA-COM, Hittite, Mini-Circuits, General Dynamics и др.);

Помимо этого, одним из направлений компании «ЭлектроПласт» является направление «Источники питания». Мы предлагаем Вам помощь Конструкторского отдела:

- Подбор оптимального решения, техническое обоснование при выборе компонента;
- Подбор аналогов;
- Консультации по применению компонента;
- Поставка образцов и прототипов;
- Техническая поддержка проекта;
- Защита от снятия компонента с производства.



Как с нами связаться

Телефон: 8 (812) 309 58 32 (многоканальный)

Факс: 8 (812) 320-02-42

Электронная почта: org@eplast1.ru

Адрес: 198099, г. Санкт-Петербург, ул. Калинина, дом 2, корпус 4, литера А.