

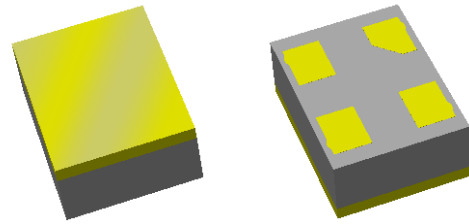

## Applications

- ISM band wireless systems
- Smart Metering systems
- Remote meter reading
- Wireless microphones
- Wireless sensing
- Wireless modules
- General purpose wireless systems



CSP-8A, 2.00 x 1.50 x 0.69 mm

## Product Features

- Usable bandwidth 26 MHz
- High attenuation
- Low Loss
- Excellent power handling
- Single-ended operation
- No impedance matching required for operation at 50Ω
- Small Size: 2.00 x 1.50 x 0.69 mm
- Ceramic Chip Scale Package (CSP)
- Hermetically sealed
- RoHS compliant, Pb-free 

## Functional Block Diagram

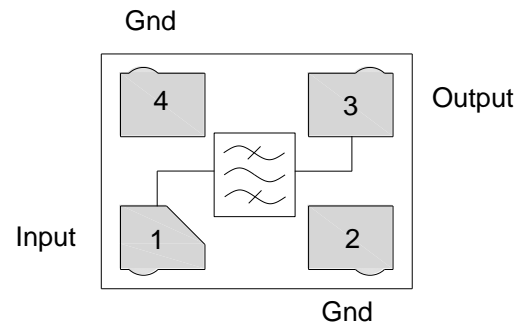

## General Description

The 856327 is a bandpass RF SAW filter specifically designed for the North American, Unlicensed, Industrial, Scientific and Medical band at 915 MHz. The filter BW covers the entire available band from 902 to 928 MHz.

The filter's low insertion loss, 50 ohm matched ports and compact footprint simplify system integration.

## Pin Configuration - Single Ended

Pin No.	Label
1	Input
3	Output
2,4	Ground

## Ordering Information

Part No.	Description
856327	Product description
856327-EVB	Evaluation board description

Standard T/R size = 10,000 units/reel

## Absolute Maximum Ratings

Parameter	Rating
Storage Temperature <sup>(1)</sup>	-40 to +85°C
Operable Temperature <sup>(2)</sup>	-40 to +85°C
RF Input Power <sup>(3)</sup>	+8 dBm

1. Operation of this device outside the parameter ranges given may cause permanent damage.
2. Specifications are not guaranteed over all operable conditions.
3. Input Power with applied CW signal at +55°C for 10K hours

## Electrical Specifications <sup>(1)</sup>

Specified Temperature Range: <sup>(2)</sup> -40°C to +85°C

Parameter <sup>(3)</sup>	Conditions	Min	Typ <sup>(4)</sup>	Max	Units
Center Frequency		-	915	-	MHz
Maximum Insertion Loss	902 – 928 MHz	-	2.3	3.0	dB
Amplitude Ripple	902 – 928 MHz	-	0.35	1.0	dB p-p
Group Delay Variation	902 – 928 MHz	-	15	50	ns p-p
Absolute Attenuation <sup>(5)</sup>	10 – 857.5 MHz	40	47	-	dB
	857.5 – 882.5 MHz	35	43	-	dB
	970 – 1005 MHz	35	40	-	dB
	1005 – 1110 MHz	40	50	-	dB
	1110 – 3000 MHz	30	37	-	dB
Input Return Loss	902 – 928 MHz	10	14	-	dB
Output Return Loss	902 – 928 MHz	10	14	-	dB
Source Impedance <sup>(6)</sup>	(single-ended)	-	50	-	Ω
Load Impedance <sup>(6)</sup>	(single-ended)	-	50	-	Ω

### Notes:

1. All specifications are based on the test circuit on page 3
2. In production, devices will be tested at room temperature to a guardbanded specification to ensure electrical compliance over temperature
3. Electrical margin has been built into the design to account for the variations due to temperature drift and manufacturing tolerances
4. Typical values are given at 25 °C
5. Relative to zero dB
6. This is the optimum impedance in order to achieve the performance shown

## 856327-EVB Evaluation Board

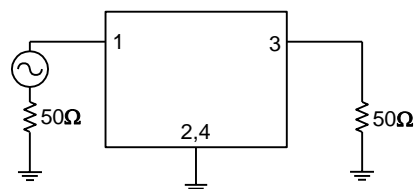
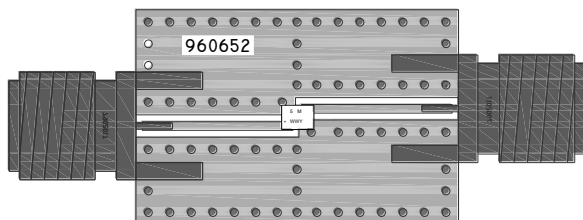

### Notes:

1. Impedance matching required.
2. PCB: .500 x .750 x .063; Construction (5 layer stack-up):  
 $\frac{1}{2}$  oz Cu Top Layer; Dielectric: *Taconic TLY-5A* (.0075);  $\frac{1}{2}$  oz Cu Middle Layer, *FR4*;  $\frac{1}{2}$  oz Cu Bottom Layer; total thickness (0.063) (dimensions are in inches).  
 Contact TriQuint for Gerber files.

## Bill of Material – 856327-EVB

Reference Des.	Value	Description	Manuf.	Part Number
U1	N/A	915 MHz SAW filter	TriQuint	856327
SMA	N/A	SMA connector	Radiall	9602-1111-018
PCB	N/A	3-layer	multiple	960652

## PCB Mounting Pattern

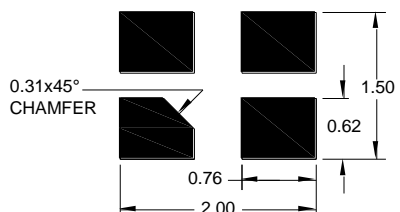

### Notes:

1. All dimensions are in millimeters. Angles are in degrees.
2. This drawing specifies the mounting pattern used on the TriQuint evaluation board for this product. Some modification may be necessary to suit end user assembly materials and processes.

**Performance Plots - 856327-EVB**

Test conditions unless otherwise noted: Temp= +25°C

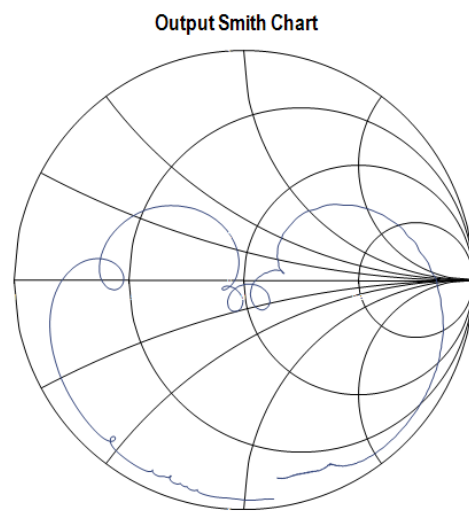
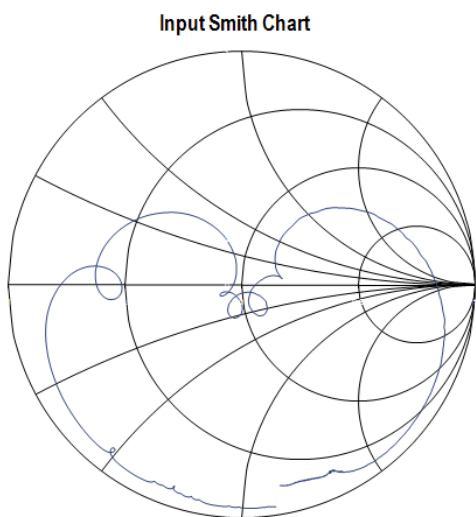
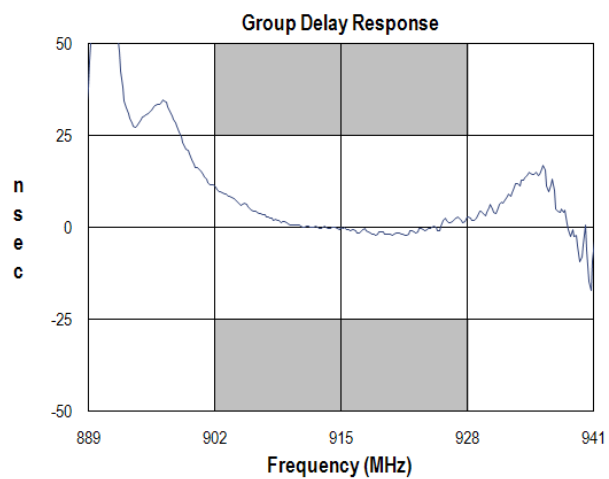
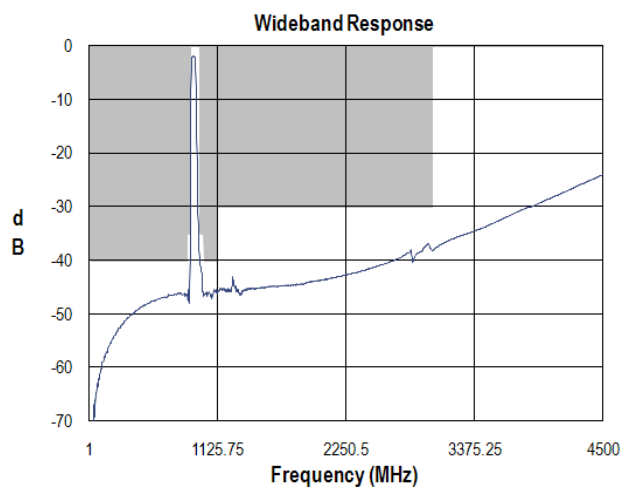
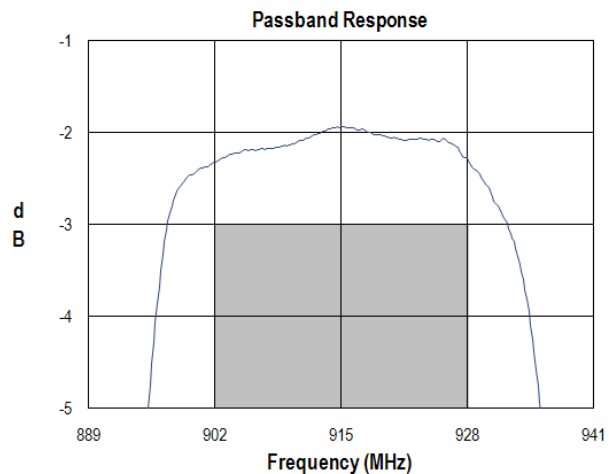
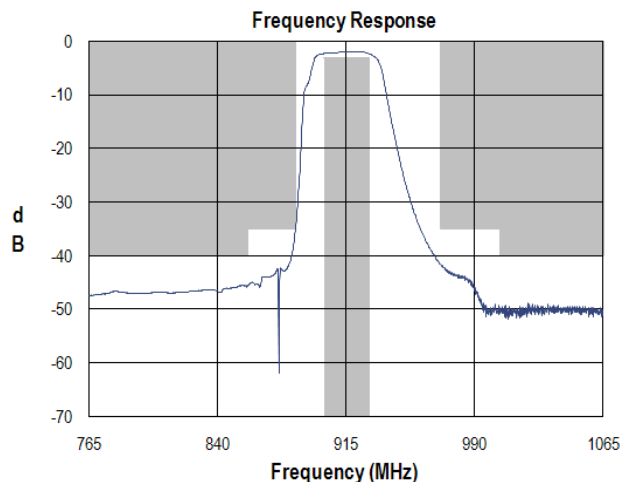

**Package Information, Marking and Dimensions**

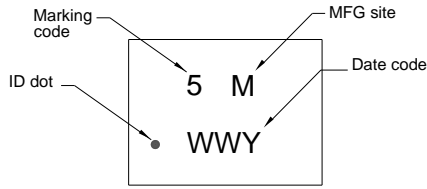

Package Style: CSP-8A  
Dimensions: 2.00 x 1.5 x 0.69 mm

Body:  $Al_2O_3$  ceramic  
Lid: Kovar or Alloy 42, Au over Ni plated  
Terminations: Au plating 0.5 - 1.0 $\mu$ m, over a 2 - 6 $\mu$ m Ni plating

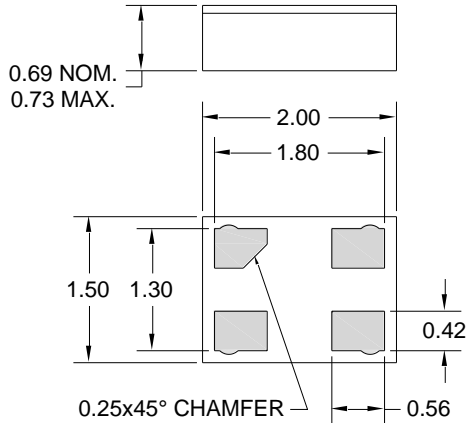

All dimensions shown are nominal in millimeters  
All tolerances are  $\pm 0.15$ mm except overall length and width  $\pm 0.10$ mm

The date code consists of day of the current year (Julian, 3 digits), Y = last digit of the year, and M = manufacturing site code

Notes:

1. All dimensions shown are typical in millimeters
2. An asterisk (\*) in front of the marking code indicates prototype.

**Tape and Reel information**

Standard T/R size = 10,000 units/reel

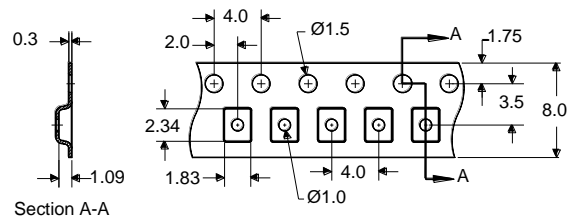
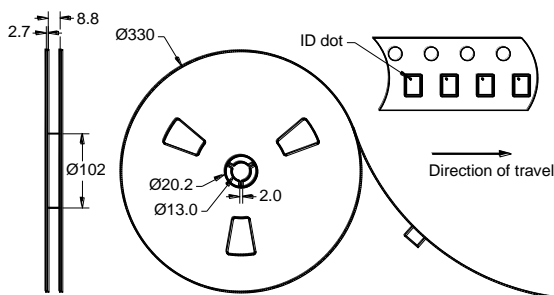

## Product Compliance Information

### ESD Sensitivity Ratings



Caution! ESD-Sensitive Device

ESD Rating: Class 0B  
Value: Passes  $\leq$  200 V  
Test: Human Body Model (HBM)  
Standard: JEDEC Standard JESD22-A114

ESD Rating: Class A  
Value: Passes  $\leq$  150  
Test: Machine Model (MM)  
Standard: JEDEC Standard JESD22-A115

### MSL Rating

Not applicable. Hermetic package.

### Solderability

Compatible with both lead-free (260°C maximum reflow temperature) and tin/lead (245°C maximum reflow temperature) soldering processes.

Refer to [Soldering Profile](#) for recommended guidelines.

### RoHs Compliance

This part is compliant with EU 2002/95/EC RoHS directive (Restrictions on the Use of Certain Hazardous Substances in Electrical and Electronic Equipment).

This product also has the following attributes:

- Lead Free
- Halogen Free (Chlorine, Bromine)
- Antimony Free
- TBBP-A (C<sub>15</sub>H<sub>12</sub>Br<sub>4</sub>O<sub>2</sub>) Free
- PFOS Free
- SVHC Free

## Contact Information

For the latest specifications, additional product information, worldwide sales and distribution locations, and information about TriQuint:

**Web:** [www.triquint.com](http://www.triquint.com)  
**Email:** [info-sales@tqs.com](mailto:info-sales@tqs.com)

**Tel:** +1.407.886.8860  
**Fax:** +1.407.886.7061

For technical questions and application information: **Email:** [flapplication.engineering@tqs.com](mailto:flapplication.engineering@tqs.com)

## Important Notice

The information contained herein is believed to be reliable. TriQuint makes no warranties regarding the information contained herein. TriQuint assumes no responsibility or liability whatsoever for any of the information contained herein. TriQuint assumes no responsibility or liability whatsoever for the use of the information contained herein. The information contained herein is provided "AS IS, WHERE IS" and with all faults, and the entire risk associated with such information is entirely with the user. All information contained herein is subject to change without notice. Customers should obtain and verify the latest relevant information before placing orders for TriQuint products. The information contained herein or any use of such information does not grant, explicitly or implicitly, to any party any patent rights, licenses, or any other intellectual property rights, whether with regard to such information itself or anything described by such information.

TriQuint products are not warranted or authorized for use as critical components in medical, life-saving, or life-sustaining applications, or other applications where a failure would reasonably be expected to cause severe personal injury or death.



Компания «ЭлектроПласт» предлагает заключение долгосрочных отношений при поставках импортных электронных компонентов на взаимовыгодных условиях!

Наши преимущества:

- Оперативные поставки широкого спектра электронных компонентов отечественного и импортного производства напрямую от производителей и с крупнейших мировых складов;
- Поставка более 17-ти миллионов наименований электронных компонентов;
- Поставка сложных, дефицитных, либо снятых с производства позиций;
- Оперативные сроки поставки под заказ (от 5 рабочих дней);
- Экспресс доставка в любую точку России;
- Техническая поддержка проекта, помощь в подборе аналогов, поставка прототипов;
- Система менеджмента качества сертифицирована по Международному стандарту ISO 9001;
- Лицензия ФСБ на осуществление работ с использованием сведений, составляющих государственную тайну;
- Поставка специализированных компонентов (Xilinx, Altera, Analog Devices, Intersil, Interpoint, Microsemi, Aeroflex, Peregrine, Syfer, Eurofarad, Texas Instrument, Miteq, Cobham, E2V, MA-COM, Hittite, Mini-Circuits, General Dynamics и др.);

Помимо этого, одним из направлений компании «ЭлектроПласт» является направление «Источники питания». Мы предлагаем Вам помощь Конструкторского отдела:

- Подбор оптимального решения, техническое обоснование при выборе компонента;
- Подбор аналогов;
- Консультации по применению компонента;
- Поставка образцов и прототипов;
- Техническая поддержка проекта;
- Защита от снятия компонента с производства.



#### Как с нами связаться

**Телефон:** 8 (812) 309 58 32 (многоканальный)

**Факс:** 8 (812) 320-02-42

**Электронная почта:** [org@eplast1.ru](mailto:org@eplast1.ru)

**Адрес:** 198099, г. Санкт-Петербург, ул. Калинина, дом 2, корпус 4, литера А.