

T OPTION  
PROVIDES CUTOUTS IN ORDER TO  
ACCOMMODATE TABS

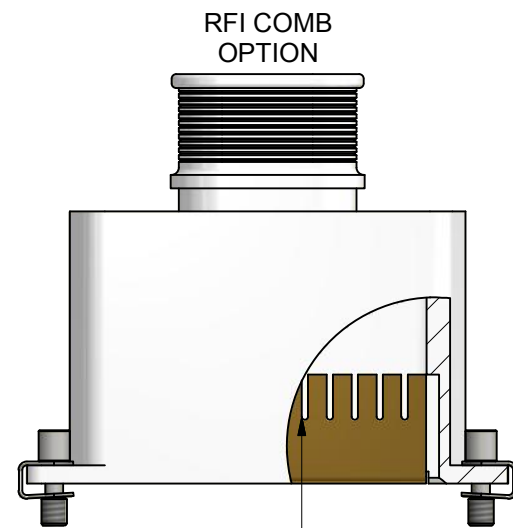
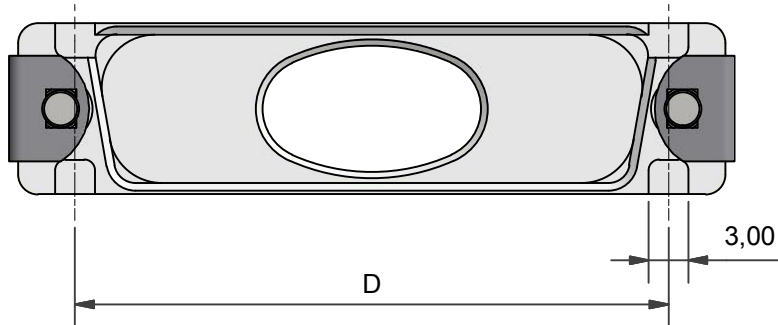

PUSH FIT RFI COMB  
(SILVER PLATED BRASS)  
COMB SUPPLIED SEPARATELY

### HARDWARE OPTIONS

CODE: (NO CODE)  
STANDARD  
SLOTTED  
HEAD SCREW

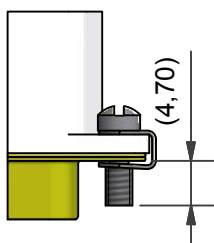

CODE: SSL  
SHORT  
SLOTTED  
HEAD SCREW

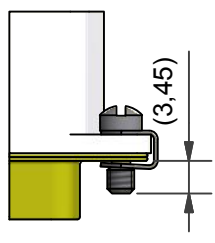

CODE: H  
HEX SOCKET  
HEAD SCREW

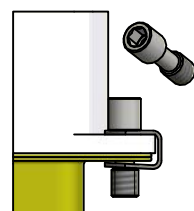

CODE: E  
EXTENDED  
SCREW

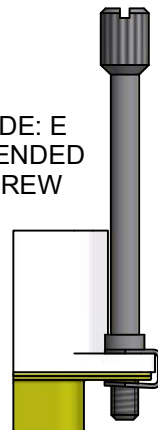

CODE: PF  
JACK POST  
(4-40 UNC)

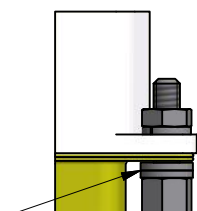

WASHERS  
WASHERS  
SHOWN FOR  
REFERENCE  
ONLY

CODE: PF-0  
THREADED  
HOLE  
4-40 UNC

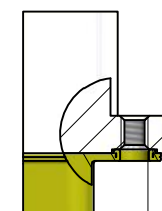

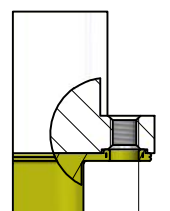

4-40UNC - 2B  
NOT  
SUPPLIED  
WITH  
HARDWARE

CODE: M3-0  
THREADED  
HOLE  
M3



M3x0.5 - 6H  
NOT  
SUPPLIED  
WITH  
HARDWARE

ORDERS CANNOT BE PLACED AGAINST ALPHA ISSUED DRAWINGS.  
ON RECEIPT OF CUSTOMER APPROVAL, THE DRAWING STATUS WILL BE RAISED TO ISSUE 1.

<table border="1"> <tr> <td>DRAWN</td> <td>DIW</td> <td>DATE</td> <td>04/08/2016</td> </tr> <tr> <td>SALES APPR</td> <td></td> <td>DATE</td> <td>04/08/2016</td> </tr> <tr> <td>DESIGN APPR</td> <td>K. SHEPPARD</td> <td>DATE</td> <td>02/03/2016</td> </tr> <tr> <td>PROD APPR</td> <td></td> <td></td> <td></td> </tr> <tr> <td>QUAL APPR</td> <td></td> <td></td> <td></td> </tr> <tr> <td>ISSUE</td> <td>REV.</td> <td>DCR</td> <td></td> </tr> <tr> <td>10</td> <td>2</td> <td>5821</td> <td></td> </tr> <tr> <td colspan="2">NCAGE CODE U5792</td> <td>WEIGHT</td> <td>---</td> </tr> </table>	DRAWN	DIW	DATE	04/08/2016	SALES APPR		DATE	04/08/2016	DESIGN APPR	K. SHEPPARD	DATE	02/03/2016	PROD APPR				QUAL APPR				ISSUE	REV.	DCR		10	2	5821		NCAGE CODE U5792		WEIGHT	---	<p>3RD ANGLE PROJECTION NOT TO SCALE</p> <p>UNLESS OTHERWISE SPECIFIED ALL DIMENSIONS IN MILLIMETRES GENERAL TOL LINEAR +/-0,25MM ANGULAR +/- 1°</p> <p><b>MATERIAL</b> SEE PART NUMBER BREAKDOWN</p> <p><b>FINISH</b> SEE PART NUMBER BREAKDOWN</p>	<p>PART NUMBER: <b>D**-1-BT-**-**</b></p> <p>TITLE: <b>D-SUB BANDING BACKSHELL</b></p> <p>ASSY USED ON: MIL-DTL-24308</p>	 <p>Polamco</p>  <p>TE connectivity</p>
DRAWN	DIW	DATE	04/08/2016																																
SALES APPR		DATE	04/08/2016																																
DESIGN APPR	K. SHEPPARD	DATE	02/03/2016																																
PROD APPR																																			
QUAL APPR																																			
ISSUE	REV.	DCR																																	
10	2	5821																																	
NCAGE CODE U5792		WEIGHT	---																																
<p>THIS DRAWING IS COPYRIGHT AND THE PROPERTY OF POLAMCO LTD IT MUST NOT BE COPIED, USED FOR MANUFACTURE OR OTHERWISE DISCLOSED WITHOUT PRIOR WRITTEN CONSENT OF THE COMPANY.</p>		<p>POLAMCO LTD, WESTON LOCK, LOWER BRISTOL ROAD BATH BA2 1EP</p>	<p>SHT <b>1</b></p> <p>DRAWING NO: <b>P10143</b></p>																																

# D25-1-BT-08E-1-C-T-L20-E

CONNECTOR TYPE \_\_\_\_\_  
 SHELL SIZE (SEE TABLE 1) \_\_\_\_\_  
 INSERT H FOR RFI COMB COMPATABILITY \_\_\_\_\_  
 ENTRY POSITION (TOP ENTRY) \_\_\_\_\_  
 TERMINATION STYLE \_\_\_\_\_  
 (BT - BAND TERMINATION STYLE)  
 ENTRY SIZE (SEE TABLE 2) \_\_\_\_\_  
 INSERT E FOR ELLIPTICAL ENTRY \_\_\_\_\_  
 ENTRY SIZES 07 AND ABOVE ONLY  
 OMIT FOR STANDARD CIRCULAR ENTRY  
 MATERIAL (TABLE 3) \_\_\_\_\_  
 PLATING (TABLE 3) \_\_\_\_\_  
 T OPTION \_\_\_\_\_  
 OMIT FOR STANDARD FLANGE  
 OPTIONAL LENGTH (5MM INCREMENTS) \_\_\_\_\_  
 (OMIT FOR STANDARD LENGTH, STANDARD LENGTH = 30MM)  
 HARDWARE OPTION \_\_\_\_\_  
 OMIT FOR STANDARD

TABLE 1

SHELL SIZE	MIL SPEC SHELL SIZE REFERENCE	A	B	C	D	MAX ENTRY (CIRCULAR)	MAX ENTRY (ELLIPTICAL)
09	1	31,19	25,00	12,93	22,86	06	08E
15	2	39,52	33,33	12,93	31,09	06	10E
25	3	53,42	47,02	12,93	44,86	06	12E
37	4	69,76	63,50	12,93	61,32	06	15E
50	5	67,31	61,12	15,75	58,98	08	16E
104	6	69,70	63,50	17,35	NA	09	18E

TABLE 2A



ENTRY SIZE (CIRCULAR)	G	H MAX
01	3,18	9,00
02	4,75	9,00
03	6,86	11,30
04	7,37	13,10
05	7,92	13,10
06	10,03	13,63
07	10,67	14,27
08	12,70	16,30
09	14,27	17,90

TABLE 2B

ENTRY SIZE (ELLIPTICAL)	E MIN	F MIN	J	EQUIV. CIRCULAR ENTRY DIAMETER
07E	13,0	9,5	16,6	(11,1)
08E	16,5	9,5	20,1	(12,7)
09E	20,5	9,5	24,1	(14,3)
10E	24,7	9,5	28,3	(15,9)
11E	29,4	9,5	33,0	(17,5)
12E	34,6	9,5	38,2	(19,1)
13E	40,2	9,5	43,8	(20,6)
14E	46,2	9,5	49,8	(22,2)
15E	52,7	9,5	56,3	(23,8)
16E	50,0	12,0	53,6	(25,4)
17E	49,2	13,9	52,8	(27,0)
18E	54,9	13,9	58,5	(28,6)

TABLE 3

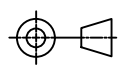
CODE	MATERIAL / PLATING
1-C	ALUMINIUM / ELECTROLESS NICKEL
1-B	ALUMINIUM / CADMIUM OLIVE DRAB OVER ELECTROLESS NICKEL
1-U	ALUMINIUM / UNPLATED
1-ZB	ALUMINIUM / ZINC COBALT OLIVE DRAB OVER ELECTROLESS NICKEL
1-ZN	ALUMINIUM / ZINC NICKEL BLACK PASSIVATE OVER ELECTROLESS NICKEL
1-Y	ALUMINIUM / YELLOW CHROMATE OVER CADMIUM
4-J	STAINLESS STEEL / PASSIVATE

DRAWN	DIW	DATE 04/08/2016	 3RD ANGLE PROJECTION NOT TO SCALE	PART NUMBER:  <b>D**-1-BT-**-**-*</b>	 <b>Polamco</b> 			
SALES APPR		04/08/2016		TITLE:  <b>D-SUB BANDING BACKSHELL</b>				
DESIGN APPR	K. SHEPPARD	02/03/2016						
PROD APPR								
QUAL APPR								
ISSUE	REV.	DCR	UNLESS OTHERWISE SPECIFIED ALL DIMENSIONS IN MILLIMETRES GENERAL TOL LINEAR +/-0,25MM ANGULAR +/- 1°	ASSY USED ON:	THIS DRAWING IS COPYRIGHT AND THE PROPERTY OF POLAMCO LTD IT MUST NOT BE COPIED, USED FOR MANUFACTURE OR OTHERWISE DISCLOSED WITHOUT PRIOR WRITTEN CONSENT OF THE COMPANY.	POLAMCO LTD, WESTON LOCK, LOWER BRISTOL ROAD BATH BA2 1EP	SHT <b>2</b>	DRAWING NO: <b>P10143</b>
<b>10</b>	<b>2</b>	<b>5821</b>						
NCAGE CODE U5792		WEIGHT ---						



Компания «ЭлектроПласт» предлагает заключение долгосрочных отношений при поставках импортных электронных компонентов на взаимовыгодных условиях!

Наши преимущества:

- Оперативные поставки широкого спектра электронных компонентов отечественного и импортного производства напрямую от производителей и с крупнейших мировых складов;
- Поставка более 17-ти миллионов наименований электронных компонентов;
- Поставка сложных, дефицитных, либо снятых с производства позиций;
- Оперативные сроки поставки под заказ (от 5 рабочих дней);
- Экспресс доставка в любую точку России;
- Техническая поддержка проекта, помощь в подборе аналогов, поставка прототипов;
- Система менеджмента качества сертифицирована по Международному стандарту ISO 9001;
- Лицензия ФСБ на осуществление работ с использованием сведений, составляющих государственную тайну;
- Поставка специализированных компонентов (Xilinx, Altera, Analog Devices, Intersil, Interpoint, Microsemi, Aeroflex, Peregrine, Syfer, Eurofarad, Texas Instrument, Miteq, Cobham, E2V, MA-COM, Hittite, Mini-Circuits, General Dynamics и др.);

Помимо этого, одним из направлений компании «ЭлектроПласт» является направление «Источники питания». Мы предлагаем Вам помощь Конструкторского отдела:

- Подбор оптимального решения, техническое обоснование при выборе компонента;
- Подбор аналогов;
- Консультации по применению компонента;
- Поставка образцов и прототипов;
- Техническая поддержка проекта;
- Защита от снятия компонента с производства.



#### Как с нами связаться

**Телефон:** 8 (812) 309 58 32 (многоканальный)

**Факс:** 8 (812) 320-02-42

**Электронная почта:** [org@eplast1.ru](mailto:org@eplast1.ru)

**Адрес:** 198099, г. Санкт-Петербург, ул. Калинина, дом 2, корпус 4, литера А.