

ADG201A/ADG202A

FEATURES

44V Supply Maximum Rating
±15V Analog Signal Range
Low R_{ON} (60Ω)
Low Leakage (0.5nA)
Break Before Make Switching
Extended Plastic Temperature Range
 (−40°C to +85°C)
Low Power Dissipation (33mW)
Available in 16-Lead DIP/SOIC and
20-Lead PLCC/LCCC Packages
Superior Second Source:
ADG201A Replaces DG201A, HI-201
ADG202A Replaces DG202

GENERAL DESCRIPTION

The ADG201A and ADG202A are monolithic CMOS devices comprising four independently selectable switches. They are designed on an enhanced LC²MOS process which gives an increased signal handling capability of ±15V. These switches also feature high switching speeds and low R_{ON}.

The ADG201A and ADG202A consist of four SPST switches. They differ only in that the digital control logic is inverted. All devices exhibit break before make switching action. Inherent in the design is low charge injection for minimum transients when switching the digital inputs.

FUNCTIONAL BLOCK DIAGRAMS

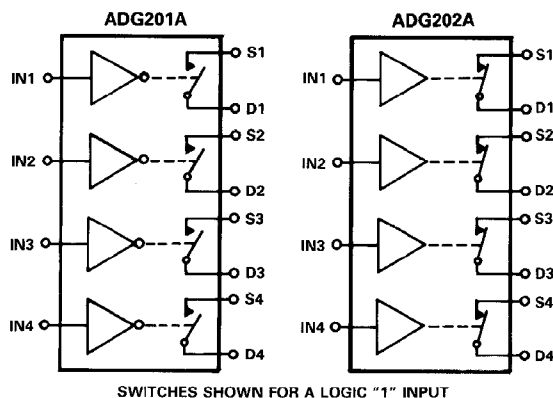

PRODUCT HIGHLIGHTS

- Extended Signal Range:**
 These switches are fabricated on an enhanced LC²MOS process, resulting in high breakdown and an increased analog signal range of ±15V.
- Single Supply Operation:**
 For applications where the analog signal is unipolar (0V to 15V), the switches can be operated from a single +15V supply.
- Low Leakage:**
 Leakage currents in the range of 500pA make these switches suitable for high precision circuits. The added feature of Break before Make allows for multiple outputs to be tied together for multiplexer applications while keeping leakage errors to a minimum.

ADG201A IN	ADG202A IN	SWITCH CONDITION
0	1	ON
1	0	OFF

Table I. Truth Table

REV. A

Information furnished by Analog Devices is believed to be accurate and reliable. However, no responsibility is assumed by Analog Devices for its use; nor for any infringements of patents or other rights of third parties which may result from its use. No license is granted by implication or otherwise under any patent or patent rights of Analog Devices.

One Technology Way, P.O. Box 9106, Norwood, MA 02062-9106, U.S.A.
 Tel: 617/329-4700 Fax: 617/326-8703 Twx: 710/394-6577
 Telex: 924491 Cable: ANALOG NORWOODMASS

ADG201A/ADG202A—SPECIFICATIONS ($V_{DD} = +15V, V_{SS} = -15V$, unless otherwise specified)

Parameter	K Version -40°C to		B Version -40°C to		T Version -55°C to		Units	Test Conditions
	25°C	+85°C	25°C	+85°C	25°C	+125°C		
ANALOG SWITCH								
Analog Signal Range	±15	±15	±15	±15	±15	±15	Volts	-10V ≤ V _S ≤ +10V I _{DS} = 1.0mA Test Circuit 1
R _{ON}	60		60		60		Ω typ	
	90	145	90	145	90	145	Ω max	
R _{ON} vs. V _D (V _S)	20		20		20		% typ	V _S = 0V, I _{DS} = 1mA
R _{ON} Drift	0.5		0.5		0.5		%/°C typ	
R _{ON} Match	5		5		5		% typ	
I _S (OFF)	0.5		0.5		0.5		nA typ	V _D = ±14V; V _S = ±14V; Test Circuit 2
OFF Input Leakage	2	100	2	100	1	100	nA max	
I _D (OFF)	0.5		0.5		0.5		nA typ	V _D = ±14V; V _S = ±14V; Test Circuit 2
OFF Output Leakage	2	100	2	100	1	100	nA max	
I _D (ON)	0.5		0.5		0.5		nA typ	V _D = ±14V; Test Circuit 3
ON Channel Leakage	2	200	2	200	1	200	nA max	
DIGITAL CONTROL								
V _{INH} , Input High Voltage		2.4		2.4		2.4	V min	
V _{INL} , Input Low Voltage		0.8		0.8		0.8	V max	
I _{INL} or I _{INH}		1		1		1	μA max	
DYNAMIC CHARACTERISTICS								
t _{OPEN}	30		30		30		ns typ	Test Circuit 4 Test Circuit 4 V _S = 10V(p-p); f = 100kHz R _L = 75Ω; Test Circuit 6 Test Circuit 7 R _S = 0Ω; C _L = 1000pF; V _S = 0V Test Circuit 5
t _{ON} ¹	300		300		300		ns max	
t _{OFF} ¹	250		250		250		ns max	
OFF Isolation	80		80		80		dB typ	
Channel-to-Channel Crosstalk	80		80		80		dB typ	
C _S (OFF)	5		5		5		pF typ	
C _D (OFF)	5		5		5		pF typ	
C _D , C _S (ON)	16		16		16		pF typ	
C _{IN} Digital Input Capacitance	5		5		5		pF typ	
Q _{INJ} Charge Injection	20		20		20		pC typ	
POWER SUPPLY								
I _{DD}	0.6		0.6		0.6		mA typ	Digital Inputs = V _{INL} or V _{INH}
I _{DD}		2		2		2	mA max	
I _{SS}	0.1		0.1		0.1		mA typ	
I _{SS}		0.2		0.2		0.2	mA max	
Power Dissipation		33		33		33	mW max	

NOTES

¹Sample tested at 25°C to ensure compliance.
Specifications subject to change without notice.

ABSOLUTE MAXIMUM RATINGS*

(T_A = +25°C unless otherwise stated)

V _{DD} to V _{SS}	44V
V _{DD} to GND	25V
V _{SS} to GND	-25V
Analog Inputs¹	
Voltage at S, D	V _{SS} - 0.3V to V _{DD} + 0.3V
Continuous Current, S or D	30mA
Pulsed Current S or D	
1ms Duration, 10% Duty Cycle	70mA
Digital Inputs¹	
Voltage at IN	V _{SS} - 2V to V _{DD} + 2V or 20mA, Whichever Occurs First

Power Dissipation (Any Package)

Up to +75°C 470mW
Derates above +75°C by 6mW/°C

Operating Temperature

Commercial (K Version) -40°C to +85°C
Industrial (B Version) -40°C to +85°C
Extended (T Version) -55°C to +125°C
Storage Temperature Range -65°C to +150°C
Lead Temperature (Soldering 10sec) +300°C

NOTE

¹Overtolerance at IN, S or D will be clamped by diodes. Current should be limited to the Maximum Rating above.

*COMMENT: Stresses above those listed under "Absolute Maximum Ratings" may cause permanent damage to the device. This is a stress rating only and functional operation of the device at these or any other conditions above those indicated in the operational sections of this specification is not implied. Exposure to absolute maximum rating conditions for extended periods may affect device reliability. Only one Absolute Maximum Rating may be applied at any one time.

CAUTION

ESD (electrostatic discharge) sensitive device. The digital control inputs are diode protected; however, permanent damage may occur on unconnected devices subject to high energy electrostatic fields. Unused devices must be stored in conductive foam or shunts. The protective foam should be discharged to the destination socket before devices are removed.



ORDERING GUIDE

Model ¹	Temperature Range	Package Option ²
ADG201AKN	-40°C to +85°C	N-16
ADG201AKR	-40°C to +85°C	R-16A
ADG201AKP	-40°C to +85°C	P-20A
ADG201ABQ	-40°C to +85°C	Q-16
ADG201ATQ	-55°C to +125°C	Q-16
ADG201ATE	-55°C to +125°C	E-20A
ADG202AKN	-40°C to +85°C	N-16
ADG202AKR	-40°C to +85°C	R-16A
ADG202AKP	-40°C to +85°C	P-20A
ADG202ABQ	-40°C to +85°C	Q-16
ADG202ATQ	-55°C to +125°C	Q-16
ADG202ATE	-55°C to +125°C	E-20A

NOTES

¹To order MIL-STD-883, Class B processed parts, add/883B to T grade part numbers. See Analog Devices Military Products Databook (1990) for military data sheet.

²E = Leadless Ceramic Chip Carrier (LCCC); N = Plastic DIP; R = 0.15" Small Outline IC (SOIC); P = Plastic Leaded Chip Carrier (PLCC); Q = Cerdip.

PIN CONFIGURATIONS

DIP, SOIC

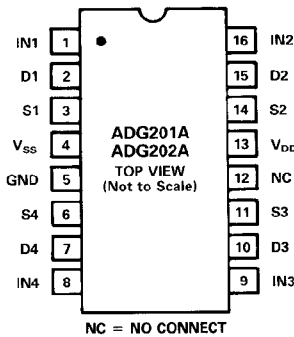

LCCC

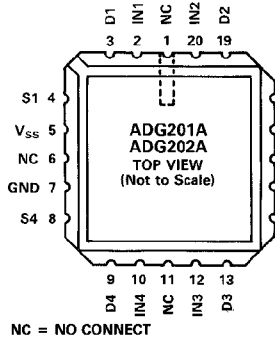

PLCC

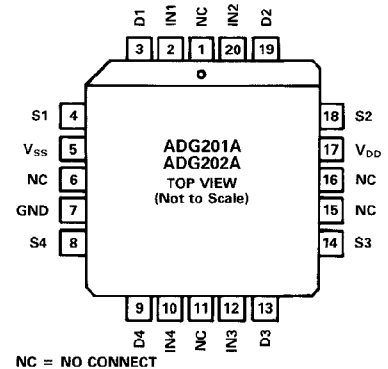

ADG201A/ADG202A FUNCTIONAL DIAGRAM

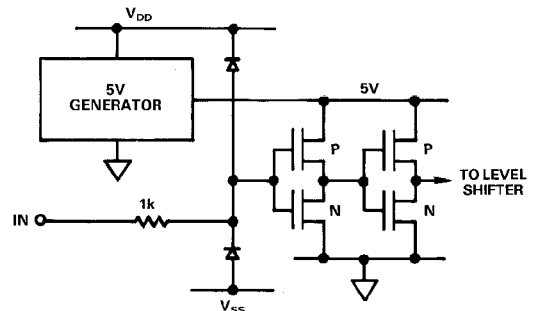
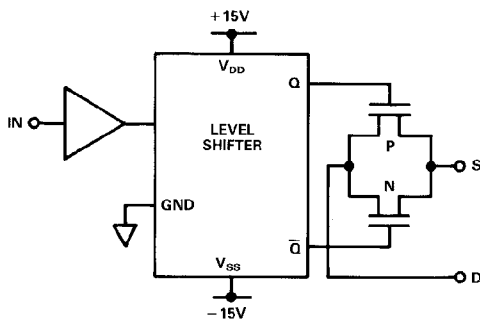
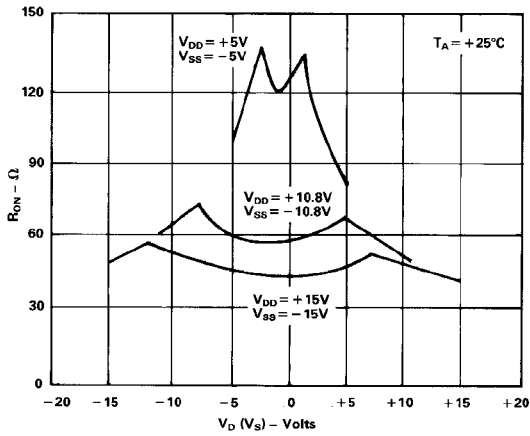

Figure 1. Typical Digital Input Cell

ADG201A/ADG202A—Typical Performance Characteristics

The switches are guaranteed functional with reduced single or dual supplies down to 4.5V.



R_{ON} as a Function of V_D (V_S): Dual Supply Voltage

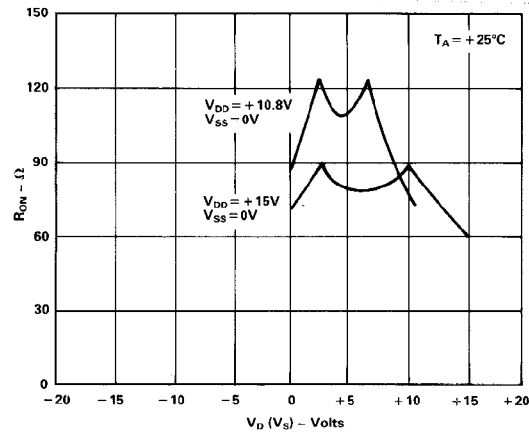

R_{ON} as a Function of V_D (V_S): Single Supply Voltage

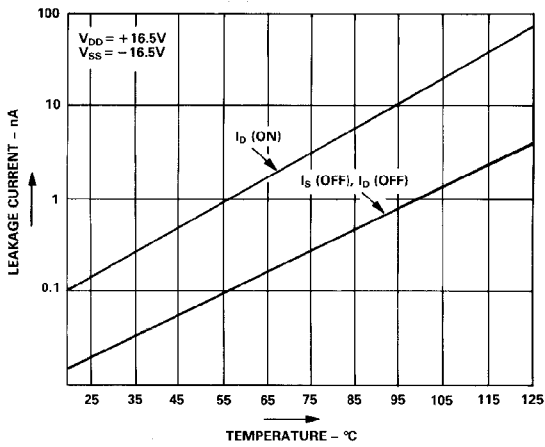

Leakage Current as a Function of Temperature (Note: Leakage Currents Reduce as the Supply Voltages Reduce)

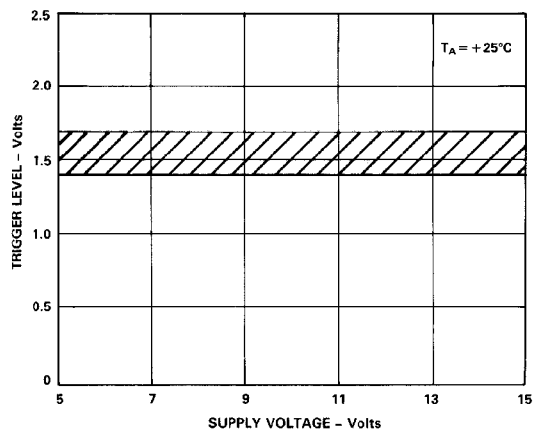

Trigger Level vs. Power Supply Voltage: Dual or Single Supply Voltage

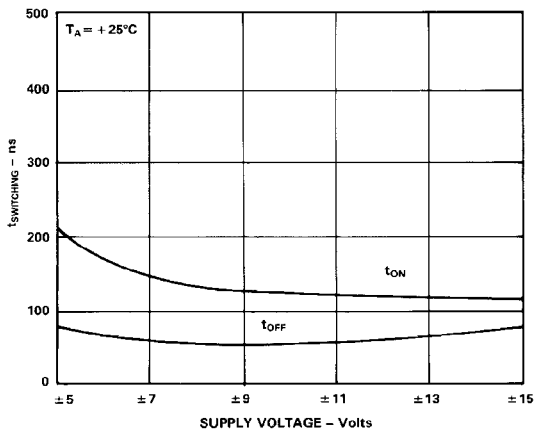

Switching Time vs. Supply Voltage (Dual Supply)

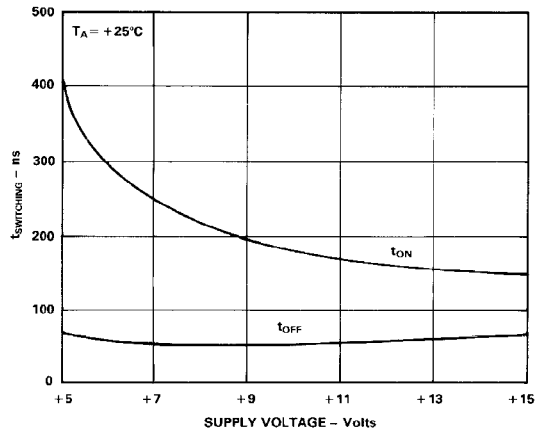

Switching Time vs. Supply Voltage (Single Supply)

Test Circuits—ADG201A/ADG202A

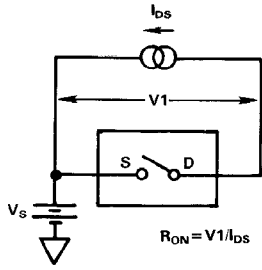

Test Circuit 1

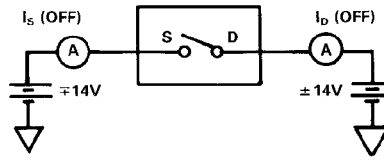

Test Circuit 2

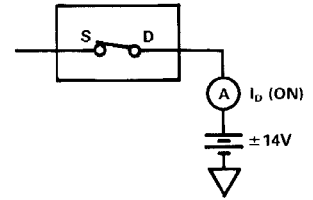

Test Circuit 3

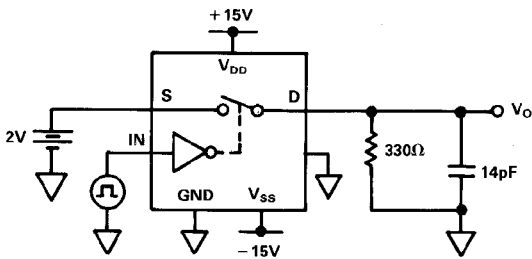

Test Circuit 4

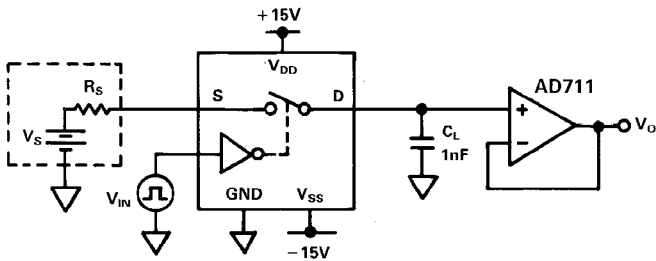
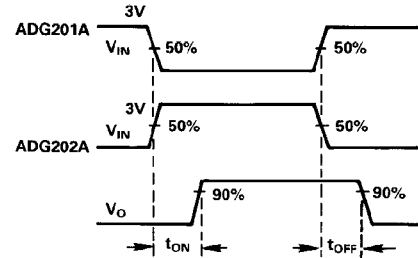

Test Circuit 5. Charge Injection

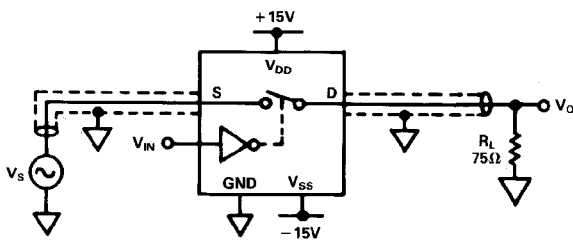
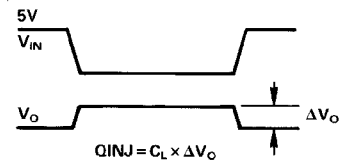

ADG201A $V_{IN} = 5V$
ADG202A $V_{IN} = 0V$

OFF ISOLATION =
 $20 \times \text{LOG} |V_s/V_O|$

Test Circuit 6. Off Isolation

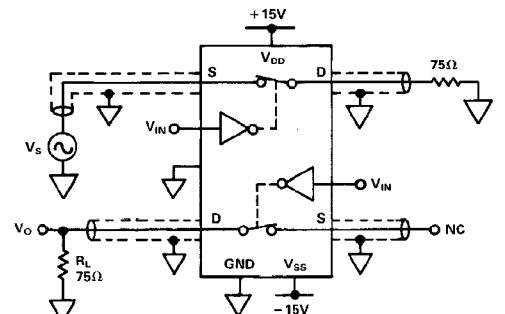

ADG201A $V_{IN} = 0V$
ADG202A $V_{IN} = 5V$

CHANNEL-TO-CHANNEL CROSSTALK =
 $20 \times \text{LOG} |V_s/V_O|$

Test Circuit 7. Channel-to-Channel Crosstalk

ADG201A/ADG202A

TERMINOLOGY

R_{ON}	Ohmic resistance between terminals OUT and S
R_{ON} Match	Difference between the R_{ON} of any two channels
I_S (OFF)	Source terminal leakage current when the switch is off
I_D (OFF)	Drain terminal leakage current when the switch is off
I_D (ON)	Leakage current that flows from the closed switch into the body
V_D (V_S)	Analog voltage on terminal D, S
C_S (OFF)	Switch input capacitance "OFF" condition
C_D (OFF)	Switch output capacitance "OFF" condition
C_{IN}	Digital input capacitance
C_D, C_S (ON)	Input or output capacitance when the switch is on

t_{ON}	Delay time between the 50% and 90% points of the digital input and switch "ON" condition
t_{OFF}	Delay time between the 50% and 90% points of the digital input and switch "OFF" condition
t_{OPEN}	"OFF" time measured between 50% points of both switches, which are connected as a multiplexer, when switching from one address state to another
V_{INL}	Maximum Input Voltage for a Logic Low
V_{INH}	Minimum Input Voltage for a Logic High
I_{INL} (I_{INH})	Input current of the digital input
V_{DD}	Most positive voltage supply
V_{SS}	Most negative voltage supply
I_{DD}	Positive supply current
I_{SS}	Negative supply current

MECHANICAL INFORMATION

OUTLINE DIMENSIONS

Dimensions shown in inches and (mm).

16-Pin Plastic (N-16)

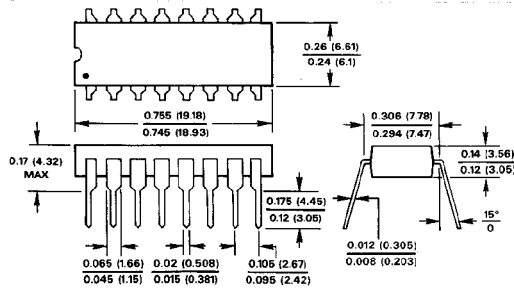

LEAD NO. 1 IDENTIFIED BY DOT OR NOTCH
LEADS ARE SOLDER OR TIN-PLATED KOVAR OR ALLOY 42

16-Pin Cerdip (Q-16)

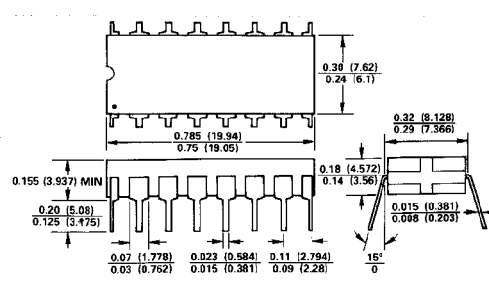

SOIC Package (R-16A)

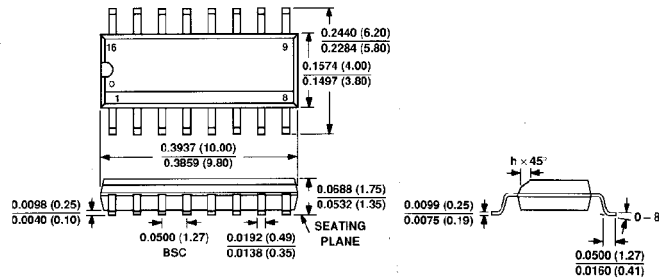

20-Terminal Leadless Ceramic Chip Carrier (E-20A)

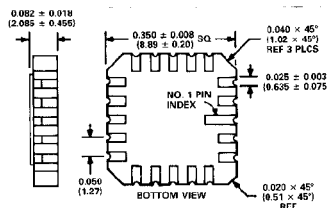

20-Terminal Plastic Leaded Chip Carrier (P-20A)

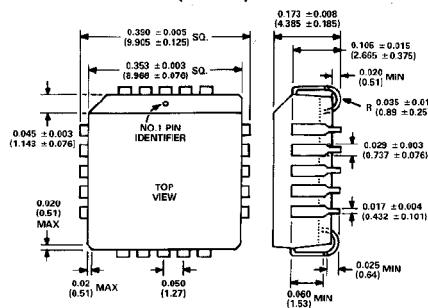



Компания «ЭлектроПласт» предлагает заключение долгосрочных отношений при поставках импортных электронных компонентов на взаимовыгодных условиях!

Наши преимущества:

- Оперативные поставки широкого спектра электронных компонентов отечественного и импортного производства напрямую от производителей и с крупнейших мировых складов;
- Поставка более 17-ти миллионов наименований электронных компонентов;
- Поставка сложных, дефицитных, либо снятых с производства позиций;
- Оперативные сроки поставки под заказ (от 5 рабочих дней);
- Экспресс доставка в любую точку России;
- Техническая поддержка проекта, помощь в подборе аналогов, поставка прототипов;
- Система менеджмента качества сертифицирована по Международному стандарту ISO 9001;
- Лицензия ФСБ на осуществление работ с использованием сведений, составляющих государственную тайну;
- Поставка специализированных компонентов (Xilinx, Altera, Analog Devices, Intersil, Interpoint, Microsemi, Aeroflex, Peregrine, Syfer, Eurofarad, Texas Instrument, Miteq, Cobham, E2V, MA-COM, Hittite, Mini-Circuits, General Dynamics и др.);

Помимо этого, одним из направлений компании «ЭлектроПласт» является направление «Источники питания». Мы предлагаем Вам помощь Конструкторского отдела:

- Подбор оптимального решения, техническое обоснование при выборе компонента;
- Подбор аналогов;
- Консультации по применению компонента;
- Поставка образцов и прототипов;
- Техническая поддержка проекта;
- Защита от снятия компонента с производства.



Как с нами связаться

Телефон: 8 (812) 309 58 32 (многоканальный)

Факс: 8 (812) 320-02-42

Электронная почта: org@eplast1.ru

Адрес: 198099, г. Санкт-Петербург, ул. Калинина, дом 2, корпус 4, литера А.