

Precision SMD TCXO/VCTCXO

AST3TQ53



ESD Sensitive



RoHS/RoHS II Compliant



5.0 x 3.2 x 2.0mm

Moisture Sensitivity Level (MSL) – 3

FEATURES:

- Standard available frequencies: 10.00, 12.80, 16.384, 19.20, 19.44, 20.00, 24.576, 25.00, 26.00, 30.72, 40.00 MHz
- LVC MOS Output or Clipped Sine Wave output
- Frequency stabilities to include ± 50 ppb, ± 100 ppb and ± 280 ppb over -40°C to $+85^{\circ}\text{C}$ operating temperature range
- Excellent Phase Noise, Harmonics and Spurious content
- Typical rms jitter of 400fs @ 40MHz carrier & 1.0ps @ 10MHz carrier over 12kHz to 20MHz BW

APPLICATIONS:

- COTS Military Radios & other Communication Hardware
- WiMax,
- LTE, BTS
- CATV, LAN, LMDS
- GPS Tracking with Hold-Over accuracy
- Test & Measurement Equipment
- Point-to-Point communication networks

STANDARD SPECIFICATIONS:

Maximum Rating

| Parameters | Rating |
|---------------------------|-------------------------------------|
| Storage Temperature Range | -55 to $+125^{\circ}\text{C}$ |
| Supply Voltage | -0.5 to 6V |
| Control Voltage | 0 to 3V |
| ESD, HBM/CDM/MM | $4\text{kV}/2\text{kV}/200\text{V}$ |

Key Electrical Specifications

| Parameters | Minimum | Typical | Maximum | Units | Notes |
|--|---|-----------|-----------|------------|--|
| Frequency Range | 10 | | 40 | MHz | |
| Standard Frequencies | 10.00, 12.80, 16.384, 19.20, 19.44, 20.00, 24.576, 25.00, 26.00, 30.72, 40.00 | | | MHz | |
| Initial Frequency Tolerance (@ $+25^{\circ}\text{C}$) at shipping | | | ± 0.5 | ppm | Relative to carrier |
| Frequency Stability Options (Ref. to Frequency @$+25^{\circ}\text{C}$) | | | | | |
| -40°C to $+85^{\circ}\text{C}$ | | | ± 50 | ppb | Option "5" |
| -40°C to $+85^{\circ}\text{C}$ | | | ± 100 | ppb | Option "1" |
| -40°C to $+85^{\circ}\text{C}$ | | | ± 280 | ppb | Option "2" |
| Frequency Stability vs. Supply Voltage Change ($V_{\text{dd}}\pm 5\%$) | | | ± 100 | ppb | |
| Frequency Stability vs. Load Change ($I_{\text{load}}\pm 5\%$) | | | ± 200 | ppb | |
| Aging (first year @ $+25^{\circ}\text{C}$) | | | ± 1.0 | ppm | |
| Aging (20 years @ $+25^{\circ}\text{C}$) | | ± 3.0 | ± 4.6 | ppm | |
| Supply Voltage (V_{dd}) | $+3.135$ | $+3.3$ | $+3.465$ | V | |
| Supply Current (I_{cc}) | | | 6.0 | mA | No load |
| Control Port (Applicable for VCTCXO only) | | | | | |
| Control Voltage Range (V_{c}) | $+0.5$ | $+1.5$ | $+2.5$ | V | |
| Center Control Voltage (V_{c}) | | $+1.5$ | | V | To be with-in ± 500 ppb of F_{c} @ 25°C (at shipping) |
| Frequency Tuning Range | ± 5 | ± 7 | $<\pm 13$ | ppm | |
| Tuning Slope | Positive | | | | |
| Linearity | | | ± 1 | % | |
| Port Impedance | 100 | | | k Ω | |

Precision SMD TCXO/VCTCXO

AST3TQ53



ESD Sensitive



RoHS/RoHS II Compliant

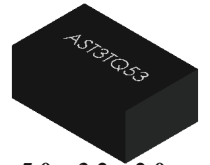

5.0 x 3.2 x 2.0mm

STANDARD SPECIFICATIONS:

(Continued)

| Parameters | Minimum | Typical | Maximum | Unites | Notes |
|---|------------|---------|---------|--------|---|
| Phase Noise (10MHz carrier frequency @25°C): | | | -95 | dBc/Hz | Offset @10Hz |
| | | | -120 | | Offset @100Hz |
| | | | -140 | | Offset @1kHz |
| | | | -145 | | Offset @10kHz |
| | | | -150 | | Offset @100kHz |
| RMS Jitter (@12kHz~5MHz BW) | 0.4 | | 1.3 | ps | Carrier Dependent |
| Clipped Sine Wave | | | | | |
| Output Level | 0.8 | | | Vp-p | |
| Output Load | 10kΩ//10pF | | | | |
| LVC MOS Output (Square Wave) | | | | | |
| V _{OH} | 2.4 | | | V | Output Load=15pF |
| V _{OL} | | | 0.4 | V | Output Load=15pF |
| Output Load | | | 15 | pF | |
| Duty Cycle | 45 | | 55 | % | @(V _{OH} - V _{OL})/2 |
| Rise/Fall Time | | | 6 | ns | Output Load=15pF |

PART IDENTIFICATION:

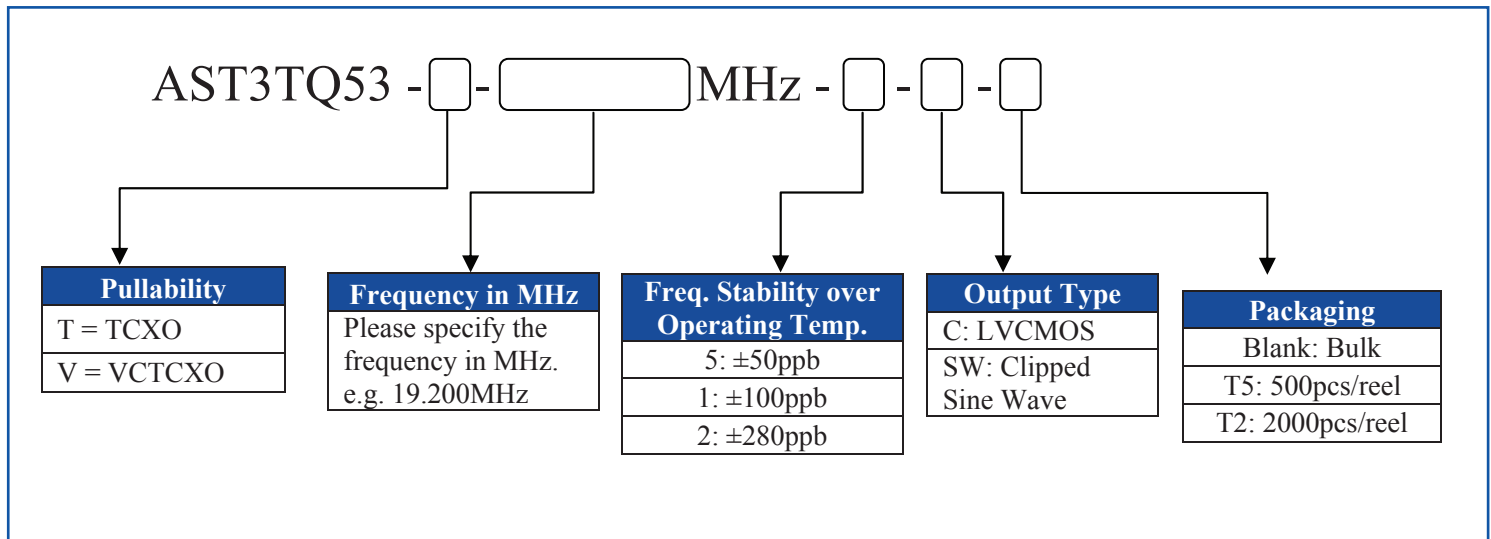

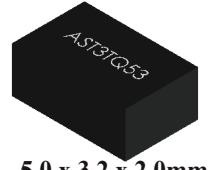

TYPICAL FREQUENCY STABILITY VS. TEMPERATURE



TYPICAL SHORT TERM STABILITY

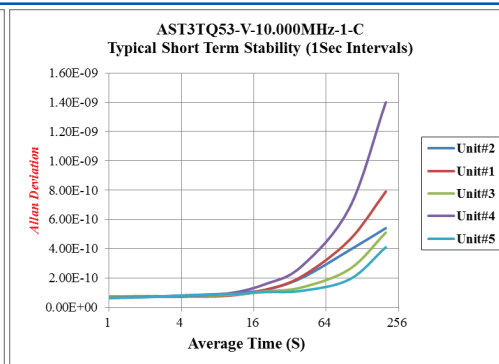



TYPICAL FREQUENCY PULL VS. CONTROL VOLTAGE



TYPICAL PHASE NOISE

10.00 MHz Carrier



Precision SMD TCXO/VCTCXO

AST3TQ53



ESD Sensitive



RoHS/RoHS II Compliant



5.0 x 3.2 x 2.0mm

TYPICAL AGING:

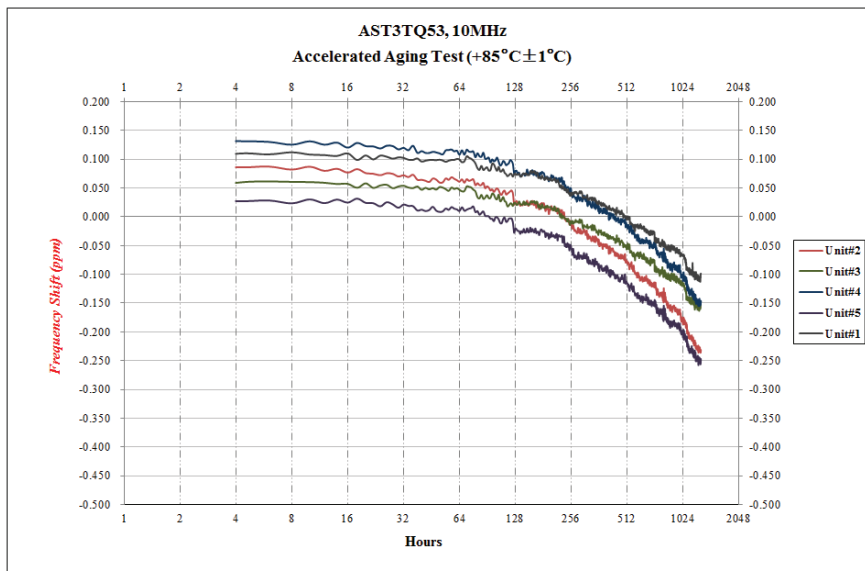

| Aging Test Conditions | |
|-----------------------|-------------|
| Series | AST3TQ53 |
| Frequency | 10MHz |
| Acquisition Mode | Cycle |
| Acquisition Time | 1129 hours |
| Test Temperature | +85°C ± 1°C |
| Number of Samples | 5pcs |

| Aging Data | | | |
|------------|------------------|-----------------|----------------------------|
| No. | Aging Time (hrs) | Aging/Day (ppm) | Projected Aging/year (ppm) |
| #1 | 1129 | -0.0039 | -0.3896 |
| #2 | 1129 | -0.0059 | -0.5925 |
| #3 | 1129 | -0.0042 | -0.4202 |
| #4 | 1129 | -0.0056 | -0.5555 |
| #5 | 1129 | -0.0055 | -0.5492 |

OUTLINE DIMENSION:

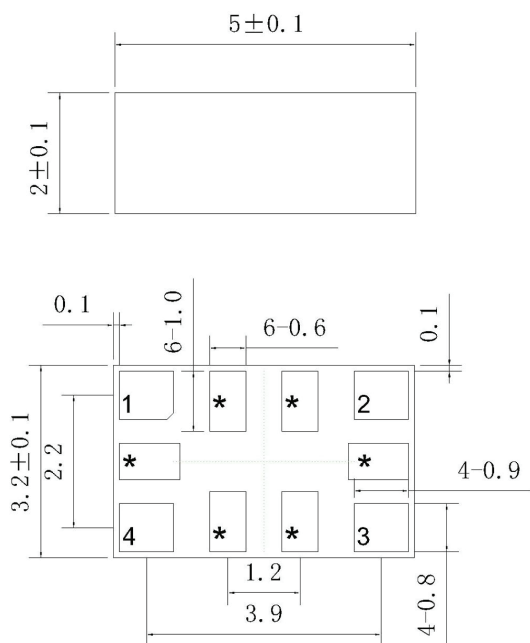

Dimensions: mm

Recommended Land Pattern

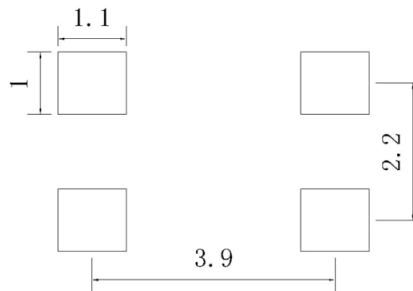

| Pin | Function |
|-----|----------------------------------|
| 1 | NC (for TCXO) Vc (for VCTCXO) |
| 2 | GND |
| 3 | Output |
| 4 | Vdd |
| * | For factory test only |

Precision SMD TCXO/VCTCXO

AST3TQ53



ESD Sensitive



RoHS/RoHS II Compliant

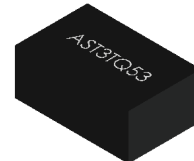

5.0 x 3.2 x 2.0mm

REFLOW PROFILE:

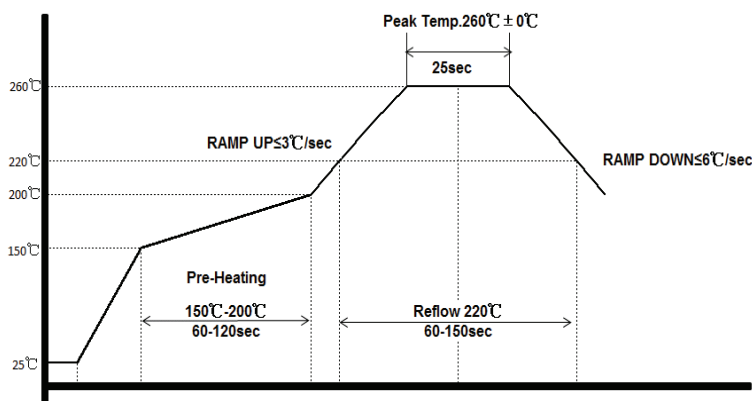

TAPE & REEL:

T5: 500pcs/reel; T2: 2000pcs/reel

MSL-3 packaging applies to MOQ=25 units (cut tape), T5 & T2.

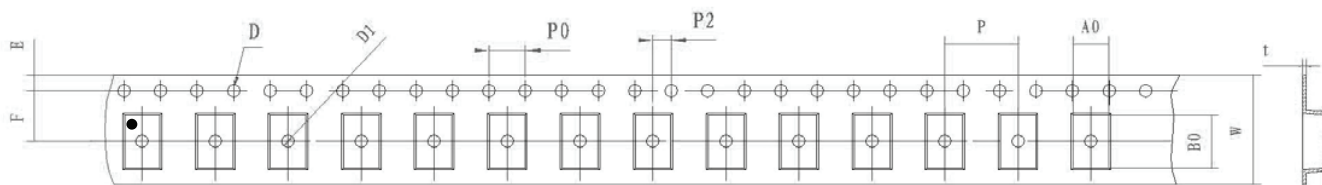

| W | A0 | B0 | K0 | P | F |
|----------|--------------|--------------|----------|---------|----------|
| 16.0±0.3 | 3.7±0.15 | 5.6±0.15 | 2.0±0.15 | 8.0±0.1 | 7.5±0.1 |
| E | D | D1 | P0 | P2 | t |
| 1.75±0.1 | 1.5+0.1/-0.0 | 1.5+0.1/-0.0 | 4.0±0.1 | 2.0±0.1 | 0.3±0.05 |

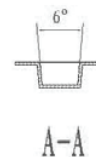

B-B

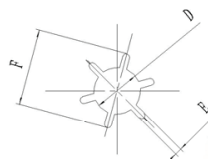
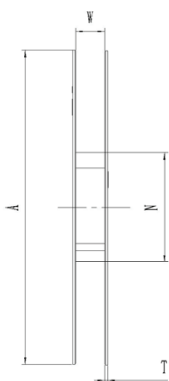
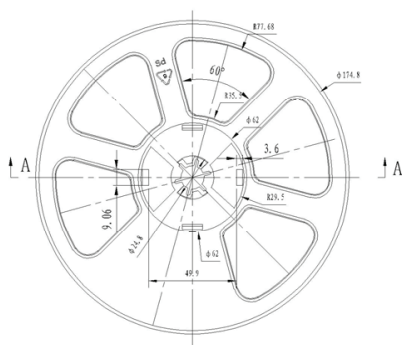

| W | A | N | T | E | F | D |
|----------|---------|--------|---------|---------|----------|----------|
| 16.4±0.3 | 178±0.5 | 62±0.4 | 1.8±0.2 | 2.0±0.5 | 21.8±0.8 | 13.5±0.3 |

Dimensions: mm

ATTENTION: Abracon Corporation's products are COTS – Commercial-Off-The-Shelf products; suitable for Commercial, Industrial and, where designated, Automotive Applications. Abracon's products are not specifically designed for Military, Aviation, Aerospace, Life-dependant Medical applications or any application requiring high reliability where component failure could result in loss of life and/or property. For applications requiring high reliability and/or presenting an extreme operating environment, written consent and authorization from Abracon Corporation is required. Please contact Abracon Corporation for more information.

ABRACON IS
ISO9001:2008
CERTIFIED



2 Faraday, Suite# B | Irvine | CA 92618 **Revised: 04.02.15**

Ph. 949.546.8000 | Fax. 949.546.8001

Visit www.abracon.com for Terms and Conditions of Sale



Компания «ЭлектроПласт» предлагает заключение долгосрочных отношений при поставках импортных электронных компонентов на взаимовыгодных условиях!

Наши преимущества:

- Оперативные поставки широкого спектра электронных компонентов отечественного и импортного производства напрямую от производителей и с крупнейших мировых складов;
- Поставка более 17-ти миллионов наименований электронных компонентов;
- Поставка сложных, дефицитных, либо снятых с производства позиций;
- Оперативные сроки поставки под заказ (от 5 рабочих дней);
- Экспресс доставка в любую точку России;
- Техническая поддержка проекта, помощь в подборе аналогов, поставка прототипов;
- Система менеджмента качества сертифицирована по Международному стандарту ISO 9001;
- Лицензия ФСБ на осуществление работ с использованием сведений, составляющих государственную тайну;
- Поставка специализированных компонентов (Xilinx, Altera, Analog Devices, Intersil, Interpoint, Microsemi, Aeroflex, Peregrine, Syfer, Eurofarad, Texas Instrument, Miteq, Cobham, E2V, MA-COM, Hittite, Mini-Circuits, General Dynamics и др.);

Помимо этого, одним из направлений компании «ЭлектроПласт» является направление «Источники питания». Мы предлагаем Вам помощь Конструкторского отдела:

- Подбор оптимального решения, техническое обоснование при выборе компонента;
- Подбор аналогов;
- Консультации по применению компонента;
- Поставка образцов и прототипов;
- Техническая поддержка проекта;
- Защита от снятия компонента с производства.



Как с нами связаться

Телефон: 8 (812) 309 58 32 (многоканальный)

Факс: 8 (812) 320-02-42

Электронная почта: org@eplast1.ru

Адрес: 198099, г. Санкт-Петербург, ул. Калинина, дом 2, корпус 4, литера А.