

# Precision SMD TCXO/VCTCXO

AST3TQ53



ESD Sensitive



RoHS/RoHS II Compliant

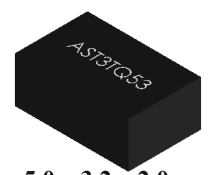

5.0 x 3.2 x 2.0mm

## Moisture Sensitivity Level (MSL) – 3

### FEATURES:

- Standard available frequencies: 10.00, 12.80, 16.384, 19.20, 19.44, 20.00, 24.576, 25.00, 26.00, 30.72, 40.00 MHz
- LVC MOS Output or Clipped Sine Wave output
- Frequency stabilities to include  $\pm 50$ ppb,  $\pm 100$ ppb and  $\pm 280$ ppb over  $-40^{\circ}\text{C}$  to  $+85^{\circ}\text{C}$  operating temperature range
- Excellent Phase Noise, Harmonics and Spurious content
- Typical rms jitter of 400fs @ 40MHz carrier & 1.0ps @ 10MHz carrier over 12kHz to 20MHz BW

### APPLICATIONS:

- COTS Military Radios & other Communication Hardware
- WiMax,
- LTE, BTS
- CATV, LAN, LMDS
- GPS Tracking with Hold-Over accuracy
- Test & Measurement Equipment
- Point-to-Point communication networks

### STANDARD SPECIFICATIONS:

#### Maximum Rating

| Parameters                | Rating                              |
|---------------------------|-------------------------------------|
| Storage Temperature Range | $-55$ to $+125^{\circ}\text{C}$     |
| Supply Voltage            | $-0.5$ to $6\text{V}$               |
| Control Voltage           | $0$ to $3\text{V}$                  |
| ESD, HBM/CDM/MM           | $4\text{kV}/2\text{kV}/200\text{V}$ |

#### Key Electrical Specifications

| Parameters   | Minimum   | Typical   | Maximum   | Units      | Notes  |
|--|---|-----------|-----------|------------|--|
| Frequency Range  | 10  |           | 40        | MHz        |  |
| Standard Frequencies   | 10.00, 12.80, 16.384, 19.20, 19.44, 20.00, 24.576, 25.00, 26.00, 30.72, 40.00 |           |           | MHz        |  |
| Initial Frequency Tolerance (@ $+25^{\circ}\text{C}$ ) at shipping                       |   |           | $\pm 0.5$ | ppm        | Relative to carrier  |
| <b>Frequency Stability Options (Ref. to Frequency @<math>+25^{\circ}\text{C}</math>)</b> |   |           |           |            |  |
| $-40^{\circ}\text{C}$ to $+85^{\circ}\text{C}$   |   |           | $\pm 50$  | ppb        | Option "5"   |
| $-40^{\circ}\text{C}$ to $+85^{\circ}\text{C}$   |   |           | $\pm 100$ | ppb        | Option "1"   |
| $-40^{\circ}\text{C}$ to $+85^{\circ}\text{C}$   |   |           | $\pm 280$ | ppb        | Option "2"   |
| Frequency Stability vs. Supply Voltage Change ( $V_{\text{dd}}\pm 5\%$ )                 |   |           | $\pm 100$ | ppb        |  |
| Frequency Stability vs. Load Change ( $\text{Load}\pm 5\%$ )                             |   |           | $\pm 200$ | ppb        |  |
| Aging (first year @ $+25^{\circ}\text{C}$ )  |   |           | $\pm 1.0$ | ppm        |  |
| Aging (20 years @ $+25^{\circ}\text{C}$ )  |   | $\pm 3.0$ | $\pm 4.6$ | ppm        |  |
| Supply Voltage ( $V_{\text{dd}}$ )   | $+3.135$  | $+3.3$    | $+3.465$  | V          |  |
| Supply Current ( $I_{\text{cc}}$ )   |   |           | 6.0       | mA         | No load  |
| <b>Control Port ( Applicable for VCTCXO only)</b>  |   |           |           |            |  |
| Control Voltage Range ( $V_{\text{c}}$ )   | $+0.5$  | $+1.5$    | $+2.5$    | V          |  |
| Center Control Voltage ( $V_{\text{c}}$ )  |   | $+1.5$    |           | V          | To be with-in $\pm 500$ ppb of $F_{\text{c}}$ @ $25^{\circ}\text{C}$ (at shipping) |
| Frequency Tuning Range   | $\pm 5$   | $\pm 7$   | $<\pm 13$ | ppm        |  |
| Tuning Slope   | Positive  |           |           |            |  |
| Linearity  |   |           | $\pm 1$   | %          |  |
| Port Impedance   | 100   |           |           | k $\Omega$ |  |

# Precision SMD TCXO/VCTCXO

AST3TQ53



ESD Sensitive



RoHS/RoHS II Compliant



5.0 x 3.2 x 2.0mm

## STANDARD SPECIFICATIONS:

(Continued)

| Parameters                                      | Minimum    | Typical | Maximum | Unites | Notes                                   |
|---|------------|---------|---------|--------|---|
| Phase Noise<br>(10MHz carrier frequency @25°C): |            |         | -95     | dBc/Hz | Offset @10Hz                            |
|   |            |         | -120    |        | Offset @100Hz                           |
|   |            |         | -140    |        | Offset @1kHz                            |
|   |            |         | -145    |        | Offset @10kHz                           |
|   |            |         | -150    |        | Offset @100kHz                          |
| RMS Jitter (@12kHz~5MHz BW)                     | 0.4        |         | 1.3     | ps     | Carrier Dependent                       |
| <b>Clipped Sine Wave</b>                        |            |         |         |        |   |
| Output Level                                    | 0.8        |         |         | Vp-p   |   |
| Output Load                                     | 10kΩ//10pF |         |         |        |   |
| <b>LVC MOS Output (Square Wave)</b>             |            |         |         |        |   |
| V <sub>OH</sub>                                 | 2.4        |         |         | V      | Output Load=15pF                        |
| V <sub>OL</sub>                                 |            |         | 0.4     | V      | Output Load=15pF                        |
| Output Load                                     |            |         | 15      | pF     |   |
| Duty Cycle                                      | 45         |         | 55      | %      | @(V <sub>OH</sub> - V <sub>OL</sub> )/2 |
| Rise/Fall Time                                  |            |         | 6       | ns     | Output Load=15pF                        |

## PART IDENTIFICATION:

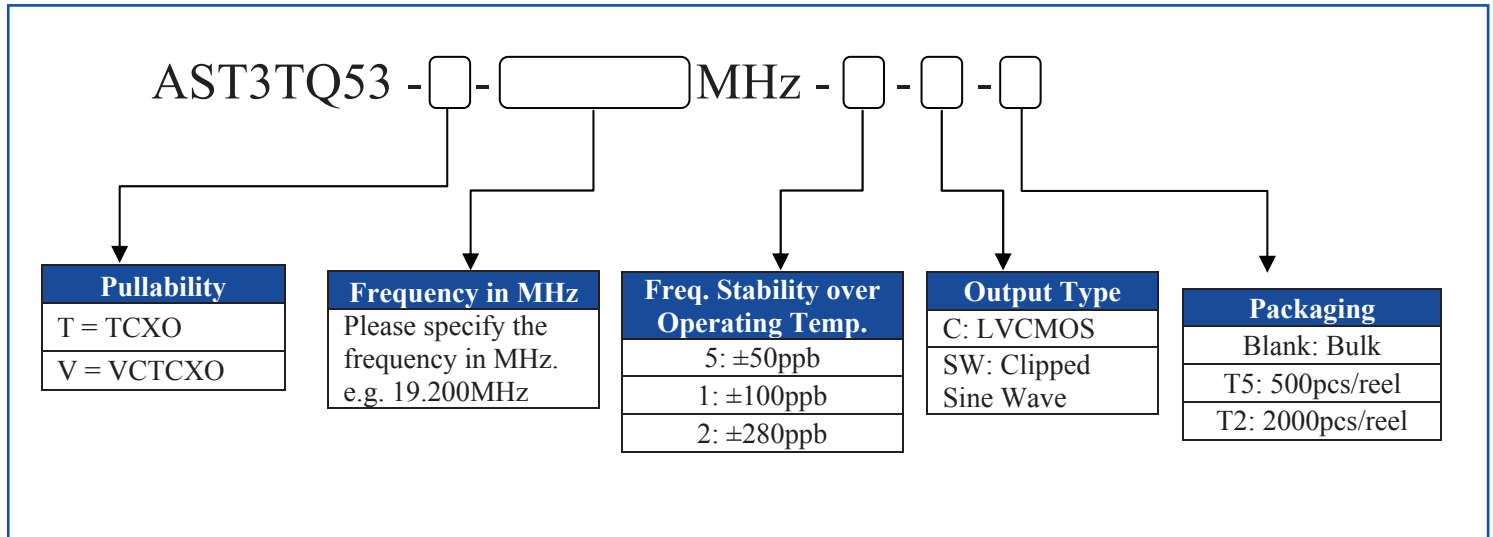



AST3TQ53



ESD Sensitive



RoHS/RoHS II Compliant

5.0 x 3.2 x 2.0mm

## TYPICAL FREQUENCY STABILITY VS. TEMPERATURE

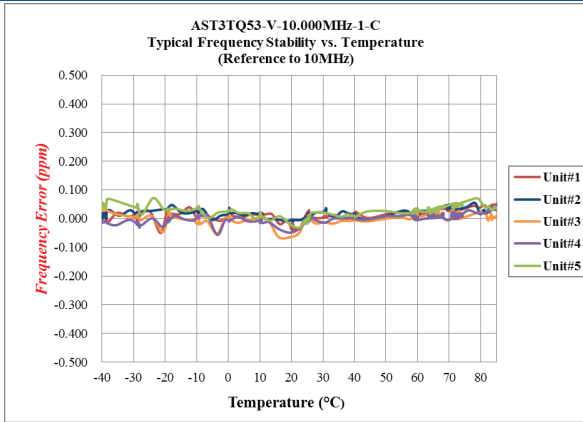

## TYPICAL SHORT TERM STABILITY

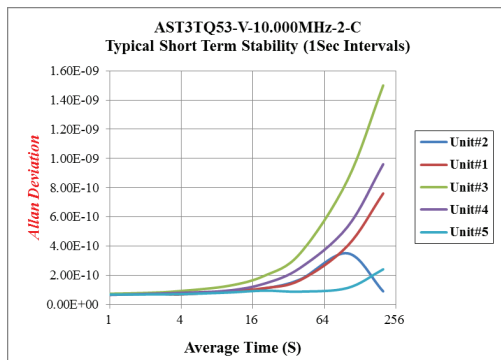
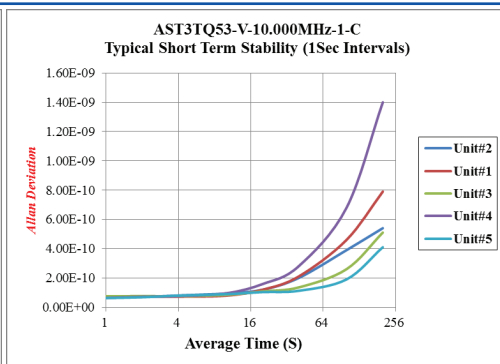



### TYPICAL FREQUENCY PULL VS. CONTROL VOLTAGE



### TYPICAL PHASE NOISE

#### 10.00 MHz Carrier



# Precision SMD TCXO/VCTCXO

AST3TQ53



ESD Sensitive



RoHS/RoHS II Compliant

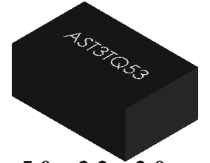

5.0 x 3.2 x 2.0mm

## TYPICAL AGING:

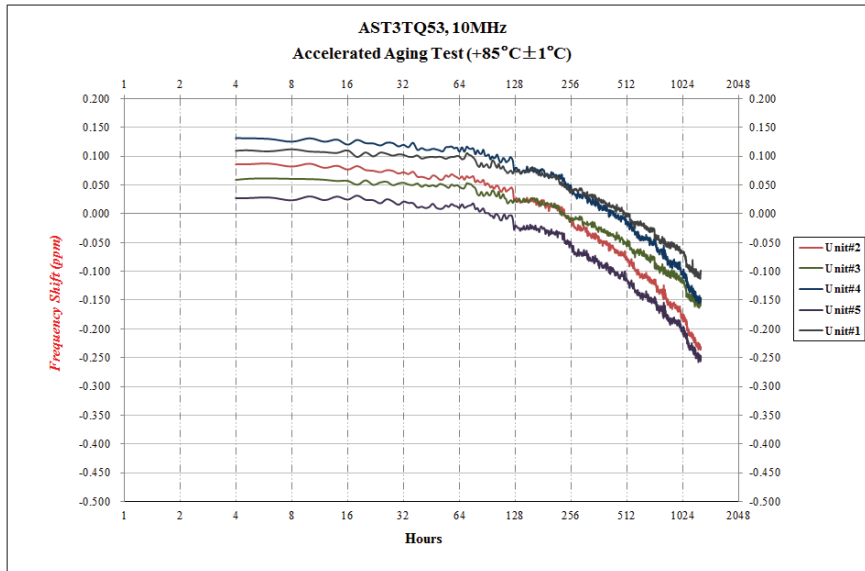

| Aging Test Conditions |             |
|-----------------------|-------------|
| Series                | AST3TQ53    |
| Frequency             | 10MHz       |
| Acquisition Mode      | Cycle       |
| Acquisition Time      | 1129 hours  |
| Test Temperature      | +85°C ± 1°C |
| Number of Samples     | 5pcs        |

| Aging Data |                  |                 |                            |
|------------|------------------|-----------------|----------------------------|
| No.        | Aging Time (hrs) | Aging/Day (ppm) | Projected Aging/year (ppm) |
| #1         | 1129             | -0.0039         | -0.3896                    |
| #2         | 1129             | -0.0059         | -0.5925                    |
| #3         | 1129             | -0.0042         | -0.4202                    |
| #4         | 1129             | -0.0056         | -0.5555                    |
| #5         | 1129             | -0.0055         | -0.5492                    |

## OUTLINE DIMENSION:



Dimensions: mm

## Recommended Land Pattern



| Pin | Function                         |
|-----|----------------------------------|
| 1   | NC (for TCXO)<br>Vc (for VCTCXO) |
| 2   | GND                              |
| 3   | Output                           |
| 4   | Vdd                              |
| *   | For factory test only            |





Компания «ЭлектроПласт» предлагает заключение долгосрочных отношений при поставках импортных электронных компонентов на взаимовыгодных условиях!

Наши преимущества:

- Оперативные поставки широкого спектра электронных компонентов отечественного и импортного производства напрямую от производителей и с крупнейших мировых складов;
- Поставка более 17-ти миллионов наименований электронных компонентов;
- Поставка сложных, дефицитных, либо снятых с производства позиций;
- Оперативные сроки поставки под заказ (от 5 рабочих дней);
- Экспресс доставка в любую точку России;
- Техническая поддержка проекта, помощь в подборе аналогов, поставка прототипов;
- Система менеджмента качества сертифицирована по Международному стандарту ISO 9001;
- Лицензия ФСБ на осуществление работ с использованием сведений, составляющих государственную тайну;
- Поставка специализированных компонентов (Xilinx, Altera, Analog Devices, Intersil, Interpoint, Microsemi, Aeroflex, Peregrine, Syfer, Eurofarad, Texas Instrument, Miteq, Cobham, E2V, MA-COM, Hittite, Mini-Circuits, General Dynamics и др.);

Помимо этого, одним из направлений компании «ЭлектроПласт» является направление «Источники питания». Мы предлагаем Вам помощь Конструкторского отдела:

- Подбор оптимального решения, техническое обоснование при выборе компонента;
- Подбор аналогов;
- Консультации по применению компонента;
- Поставка образцов и прототипов;
- Техническая поддержка проекта;
- Защита от снятия компонента с производства.



#### Как с нами связаться

**Телефон:** 8 (812) 309 58 32 (многоканальный)

**Факс:** 8 (812) 320-02-42

**Электронная почта:** [org@eplast1.ru](mailto:org@eplast1.ru)

**Адрес:** 198099, г. Санкт-Петербург, ул. Калинина, дом 2, корпус 4, литера А.