

LOW NOISE 150mA LDO REGULATOR R1122N SERIES

■ OUTLINE

The R1122N Series are voltage regulator ICs with high output voltage accuracy, extremely low supply current, low ON-resistance and high ripple rejection by CMOS process. Each of these voltage regulator ICs consists of a voltage reference unit, an error amplifier, resistors, a current limit circuit, and a chip enable circuit. These ICs perform with low dropout voltage and a chip enable function.

The line transient response and load transient response of the R1122N Series are excellent, thus these ICs are very suitable for the power supply for hand-held communication equipment. The output voltage of these ICs is fixed with high accuracy.

Since the package for these ICs are SOT-23-5 (Mini-mold) package, high density mounting of the ICs on boards is possible.

■ FEATURES

- Ultra-Low Supply Current.....TYP. 100 μ A
- Standby ModeTYP. 0.1 μ A
- Low Dropout VoltageTYP. 0.19V ($I_{OUT} = 100\text{mA}$, 3V Output type)
- High Ripple RejectionTYP. 80dB ($f = 1\text{kHz}$)
- Low Temperature-Drift Coefficient of Output VoltageTYP. $\pm 100\text{ppm}/^{\circ}\text{C}$
- Excellent Line RegulationTYP. 0.05%/V
- High Accuracy Output Voltage..... $\pm 2.0\%$
- Small PackageSOT-23-5 (Mini-mold)
- Output VoltageStepwise setting with a step of 0.1V in the range of 1.5V to 5.0V is possible.
- Built-in chip enable circuit (2 Types; A: active "L", B: active "H")
- Built-in Fold-back protection circuitShort Current Typ. 30mA
- PinoutSimilar to the TK112, TK111
- Ceramic Capacitors are Recommendable to be used with this IC.

■ APPLICATIONS

- Power source for cellular phones such as GSM, CDMA, PCS and so forth.
- Power source for domestic appliances such as cameras, VCRs and camcorders.
- Power source for battery-powered equipment.

■ BLOCK DIAGRAM

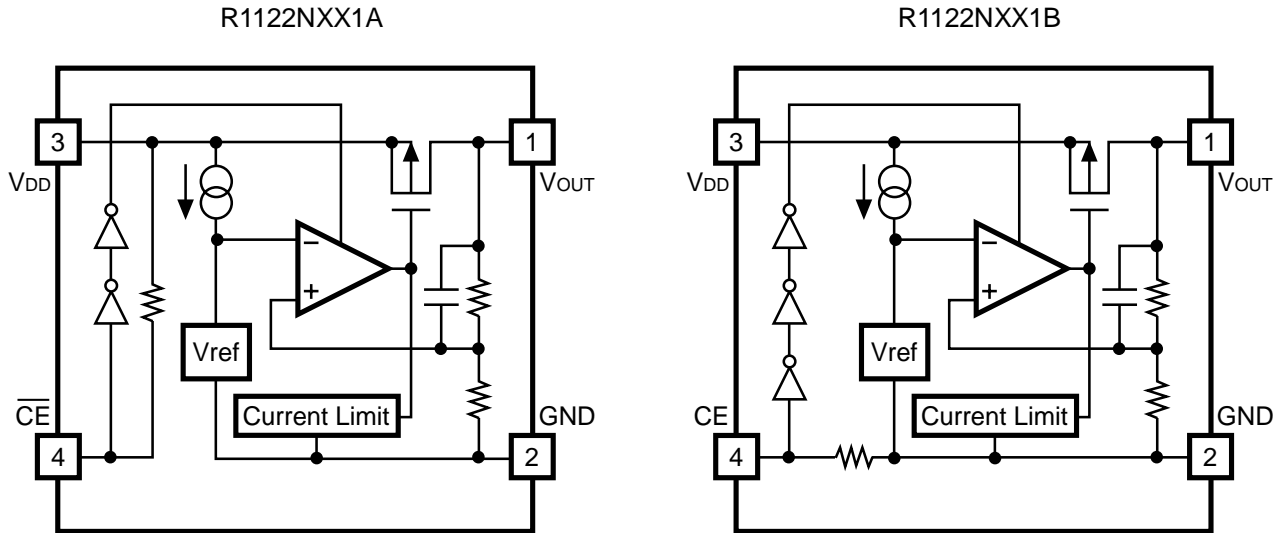

■ SELECTION GUIDE

The output voltage, the active type, the packing type, and the taping type for the ICs can be selected at the user's request. The selection can be made by designating the part number as shown below :

R1122NXX1X-XX ←Part Number
 ↑ ↑ ↑
 a b c

Code	Contents
a	Setting Output Voltage (V _{OUT}) : Stepwise setting with a step of 0.1V in the range of 1.5V to 5.0V is possible.
b	Designation of Active Type : A : active "L" type B : active "H" type
c	Designation of Taping Type : Ex. TR, TL (refer to Taping Specifications; TR type is the standard direction.)

■ PIN CONFIGURATION

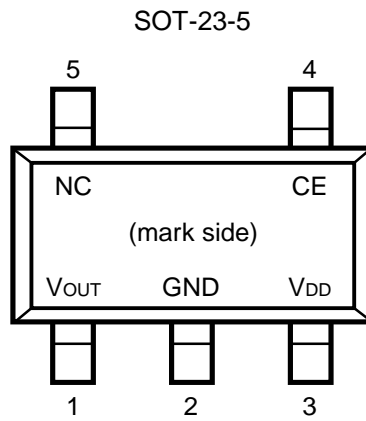

■ PIN DESCRIPTION

Pin No.	Symbol	Description
1	V_{OUT}	Output pin
2	GND	Ground Pin
3	V_{DD}	Input Pin
4	\overline{CE} or CE	Chip Enable Pin
5	NC	No Connection

■ ABSOLUTE MAXIMUM RATINGS

Symbol	Item	Rating	Unit
V_{IN}	Input Voltage	7.0	V
V_{CE}	Input Voltage (CE or CE Pin)	-0.3 ~ $V_{IN}+0.3$	V
V_{OUT}	Output Voltage	-0.3 ~ $V_{IN}+0.3$	V
I_{OUT}	Output Current	200	mA
P_D	Power Dissipation	250	mW
T_{opt}	Operating Temperature Range	-40 ~ 85	°C
T_{stg}	Storage Temperature Range	-55 ~ 125	°C

■ ELECTRICAL CHARACTERISTICS

● R1122NXX1A

$T_{opt} = 25^{\circ}\text{C}$

Symbol	Item	Conditions	MIN.	TYP.	MAX.	Unit
V_{OUT}	Output Voltage	$V_{IN} = \text{Set } V_{OUT}+1\text{V}$ $1\text{mA} \leq I_{OUT} \leq 30\text{mA}$	V_{OUT} $\times 0.98$		V_{OUT} $\times 1.02$	V
I_{OUT}	Output Current	$V_{IN} = \text{Set } V_{OUT}+1\text{V}$ When $V_{OUT} = \text{Set } V_{OUT}-0.1\text{V}$	150			mA
$\Delta V_{OUT}/\Delta I_{OUT}$	Load Regulation	$V_{IN} = \text{Set } V_{OUT}+1\text{V}$ $1\text{mA} \leq I_{OUT} \leq 80\text{mA}$		12	40	mV
V_{DIF}	Dropout Voltage	refer to the ELECTRICAL CHARACTERISTICS by OUTPUT VOLTAGE				
I_{SS}	Supply Current	$V_{IN} = \text{Set } V_{OUT}+1\text{V}$		100	170	μA
$I_{standby}$	Supply Current (Standby)	$V_{IN} = V_{CE} = \text{Set } V_{OUT}+1\text{V}$		0.1	1.0	μA
$\Delta V_{OUT}/\Delta V_{IN}$	Line Regulation	Set $V_{OUT}+0.5\text{V} \leq V_{IN} \leq 8\text{V}$ $I_{OUT} = 30\text{mA}$		0.05	0.20	%/V
RR	Ripple Rejection	$f = 1\text{KHz}$, Ripple 0.5Vp-p $V_{IN} = \text{Set } V_{OUT}+1\text{V}$		80		dB
V_{IN}	Input Voltage		2.0		6.0	V
$\Delta V_{OUT}/\Delta T$	Output Voltage Temperature Coefficient	$I_{OUT} = 30\text{mA}$ $-40^{\circ}\text{C} \leq T_{opt} \leq 85^{\circ}\text{C}$		± 100		ppm/ °C
I_{lim}	Short Current Limit	$V_{OUT} = 0\text{V}$		30		mA
R_{PU}	CE Pull-up Resistance		2.5	5	10	$\text{M}\Omega$
V_{CEH}	CE Input Voltage "H"		1.5		V_{IN}	V
V_{CEL}	CE Input Voltage "L"		0		0.25	V
en	Output Noise	$\text{BW} = 10\text{Hz} \sim 100\text{kHz}$		30		μV_{rms}

● R1122NXX1B

Topt=25°C

Symbol	Item	Conditions	MIN.	TYP.	MAX.	Unit
V _{OUT}	Output Voltage	V _{IN} = Set V _{OUT} +1V 1mA ≤ I _{OUT} ≤ 30mA	V _{OUT} ×0.98		V _{OUT} ×1.02	V
I _{OUT}	Output Current	V _{IN} = Set V _{OUT} +1V When V _{OUT} = Set V _{OUT} -0.1V	150			mA
ΔV _{OUT} /ΔI _{OUT}	Load Regulation	V _{IN} = Set V _{OUT} +1V 1mA ≤ I _{OUT} ≤ 80mA		12	40	mV
V _{DIF}	Dropout Voltage	refer to the ELECTRICAL CHARACTERISTICS by OUTPUT VOLTAGE				
I _{SS}	Supply Current	V _{IN} = Set V _{OUT} +1V		100	170	μA
I _{standby}	Supply Current (Standby)	V _{IN} = Set V _{OUT} +1V V _{CE} = GND		0.1	1.0	μA
ΔV _{OUT} /ΔV _{IN}	Line Regulation	Set V _{OUT} +0.5V ≤ V _{IN} ≤ 8V I _{OUT} = 30mA		0.05	0.20	%/V
RR	Ripple Rejection	f = 1KHz, Ripple 0.5Vp-p V _{IN} = Set V _{OUT} +1V		80		dB
V _{IN}	Input Voltage		2.0		6.0	V
ΔV _{OUT} /ΔT	Output Voltage Temperature Coefficient	I _{OUT} = 30mA -40°C ≤ Topt ≤ 85°C		±100		ppm /°C
I _{lim}	Short Current Limit	V _{OUT} = 0V		30		mA
R _{PD}	CE Pull-down Resistance		2.5	5	10	MΩ
V _{CEH}	CE Input Voltage "H"		1.5		V _{IN}	V
V _{CEL}	CE Input Voltage "L"		0		0.25	V
en	Output Noise	BW = 10Hz ~ 100kHz		30		μVrms

● ELECTRICAL CHARACTERISTICS by OUTPUT VOLTAGE

Topt = 25°C

Output Voltage V _{OUT} (V)	Dropout Voltage		
	V _{DIF} (V)		
	Conditions	TYP.	MAX.
1.5 ≤ V _{OUT} ≤ 1.6	I _{OUT} = 100mA	0.32	0.55
1.7 ≤ V _{OUT} ≤ 1.8		0.28	0.47
1.9 ≤ V _{OUT} ≤ 2.3		0.25	0.35
2.4 ≤ V _{OUT} ≤ 2.7		0.20	0.29
2.8 ≤ V _{OUT} ≤ 5.0		0.19	0.26

■ OPERATION

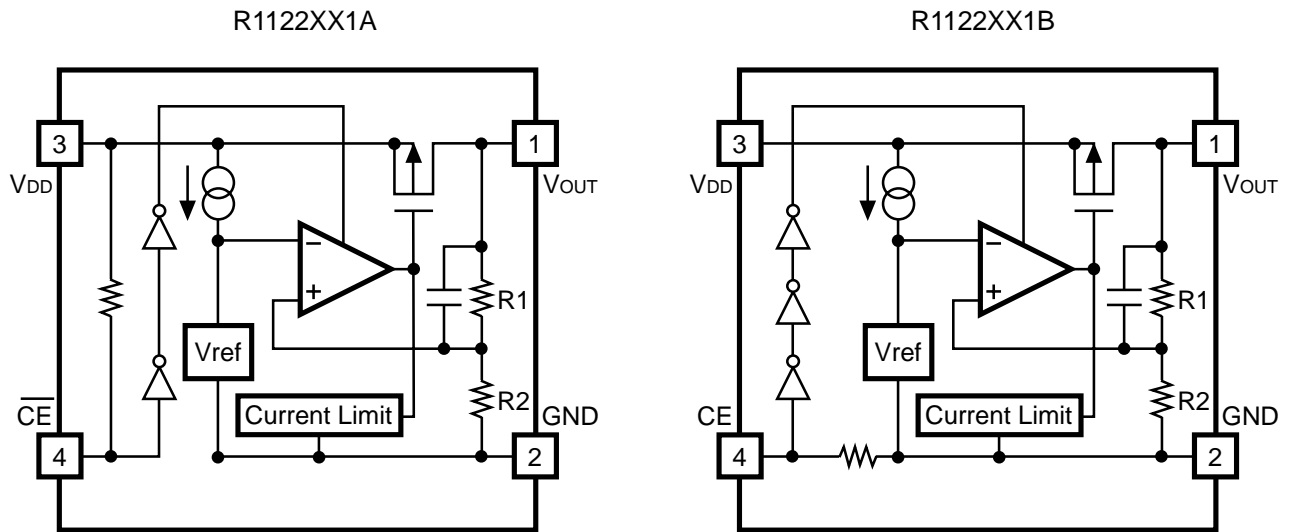

In these ICs, fluctuation of Output Voltage, V_{OUT} is detected by Feed-back Registers, R1 and R2, and the result is compared with a reference voltage by Error Amplifier, so that a constant voltage is output.

A current limit circuit for protection at short mode, and a chip enable circuit are included.

TEST CIRCUITS

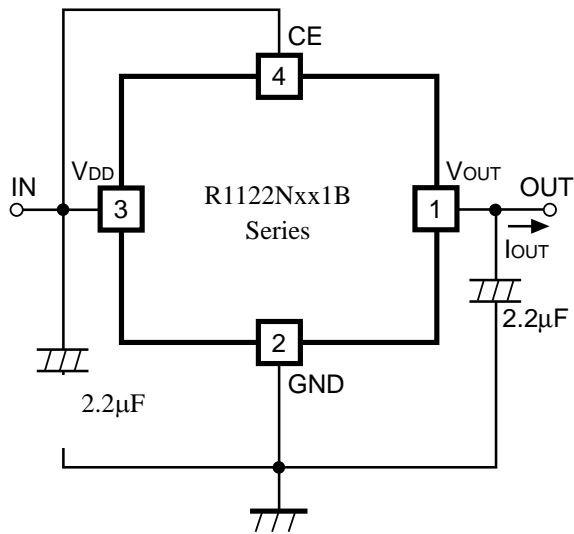

Fig.1 Standard test Circuit

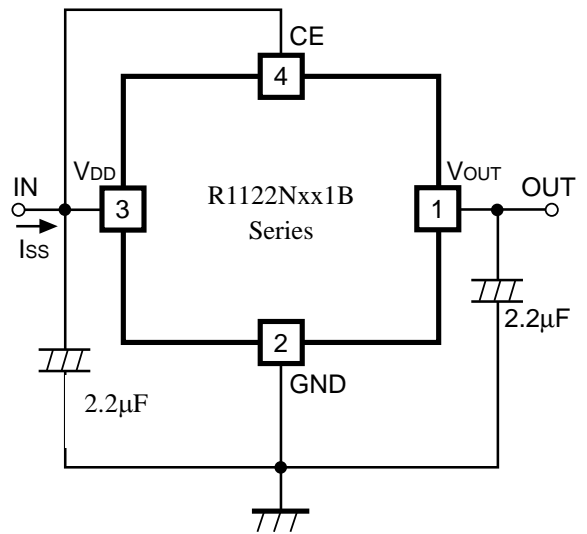

Fig.2 Supply Current Test Circuit

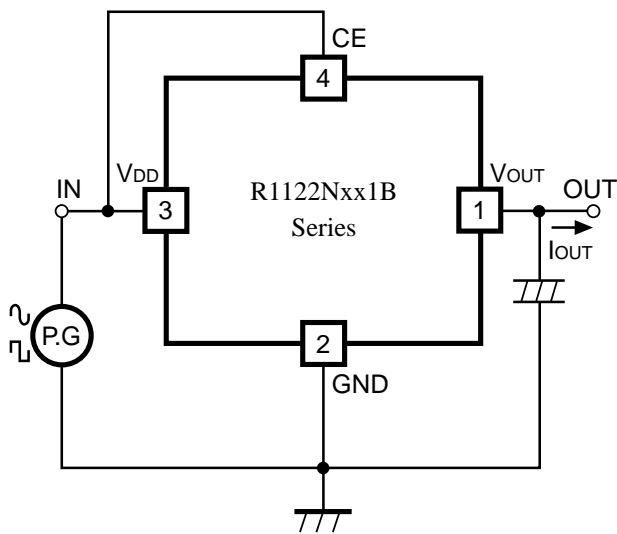

Fig.3 Ripple Rejection, Line Transient Response Test Circuit

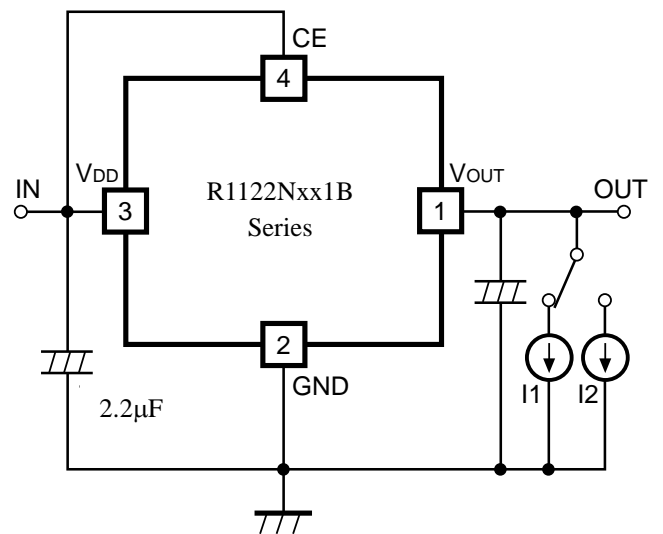

Fig.4 Load Transient Response Test Circuit

■ TECHNICAL NOTES

When using these ICs, consider the following points:

Phase Compensation

In these ICs, phase compensation is made for securing stable operation even if the load current is varied. For this purpose, be sure to use a capacitor C_{OUT} with good frequency characteristics and ESR (Equivalent Series Resistance).

(note: When the additional ceramic capacitors are connected to the Output Pin with Output capacitor for phase compensation, the operation might be unstable. Because of this, test these ICs with as same external components as ones to be used on the PCB.)

Recommended Capacitors; GRM40X5R225K6.3 (Murata)

GRM40-034X5R335K6.3 (Murata)

GRM40-034X5R475K6.3 (Murata)

PCB Layout

Make VDD and GND line sufficient. When the impedance of these is high, it would be a cause of picking up the noise or unstable operation. Connect a capacitor with a capacitance of 2.2 μ F or more between VDD and GND pin as close as possible. Set external components, especially output capacitor as close as possible to the ICs and make wiring shortest.

■ TYPICAL APPLICATION

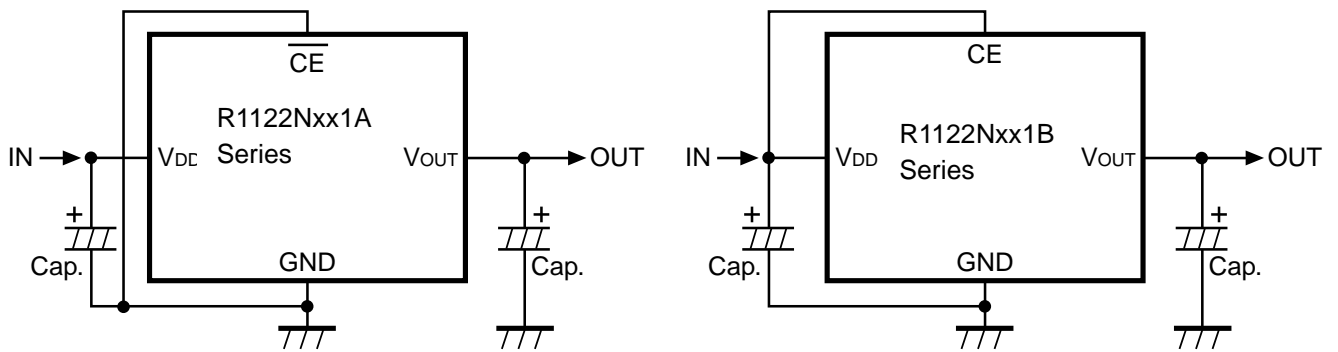

(External Components)

Output Capacitor; Ceramic 2.2 μ F (Set Output Voltage in the range from 2.5 to 5.0V)

Ceramic 4.7 μ F (Set Output Voltage in the range from 1.5 to 2.5V)

Input Capacitor; Ceramic 2.2 μ F

■ TYPICAL CHARACTERISTICS

1) Output Voltage vs. Output Current

R11x2N151B

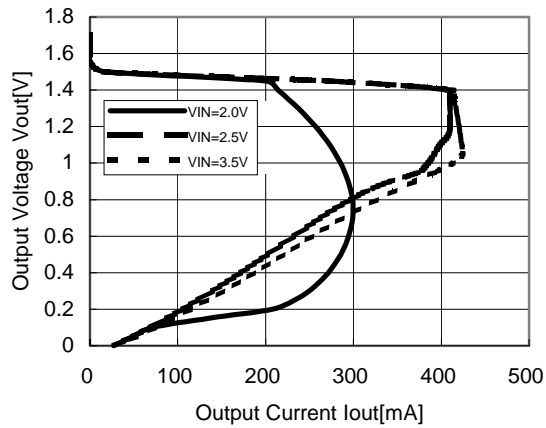

R11x2N201B

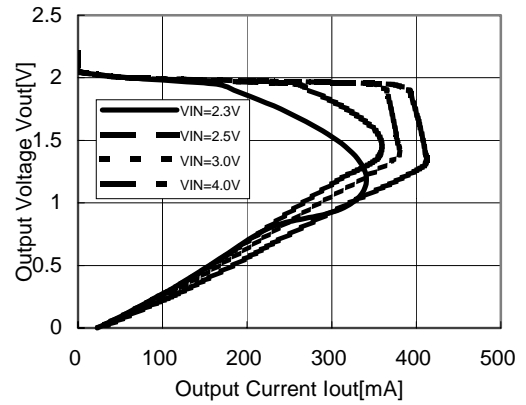

R11x2N301B

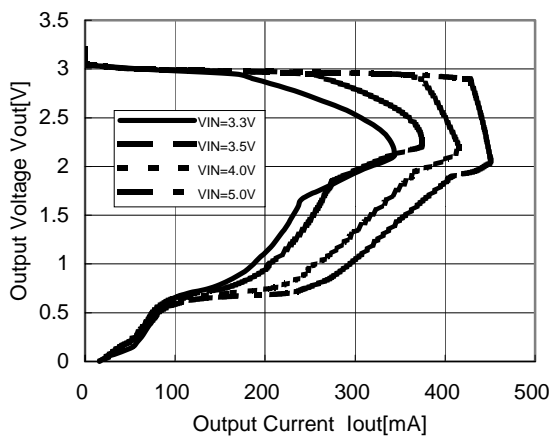

R11x2N401B

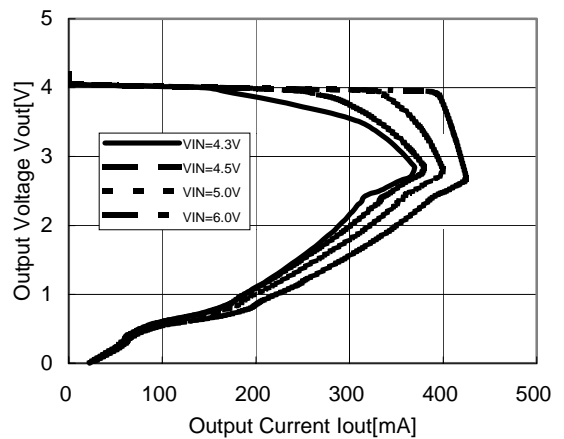

R11x2N501B

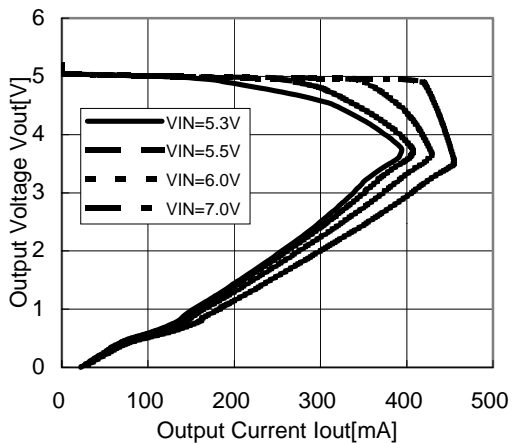

2) Output Voltage vs. Input Voltage

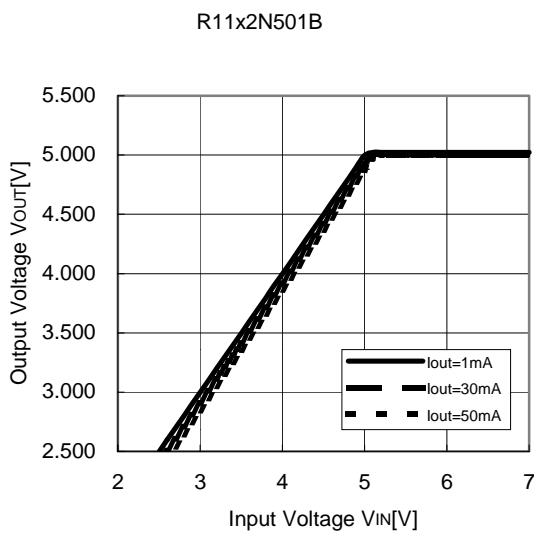
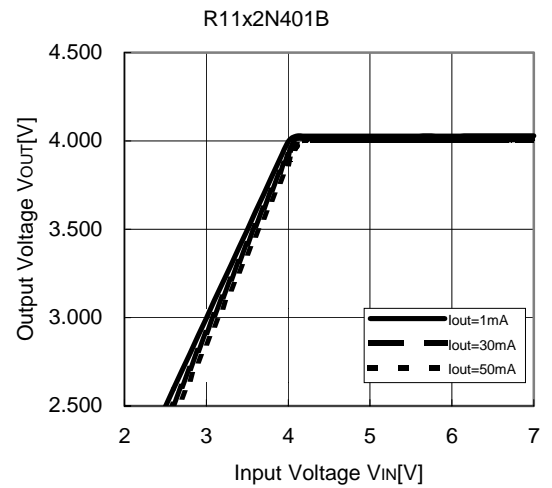
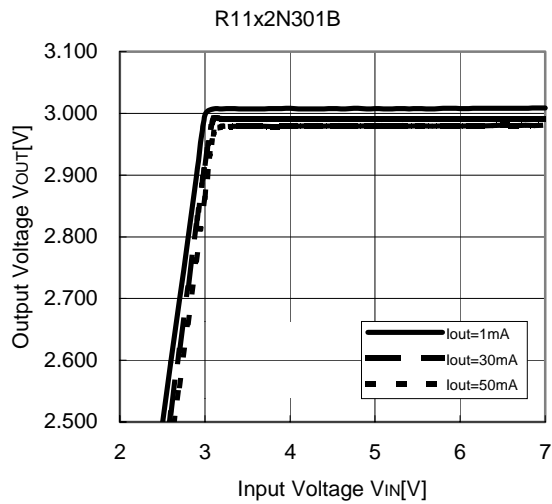
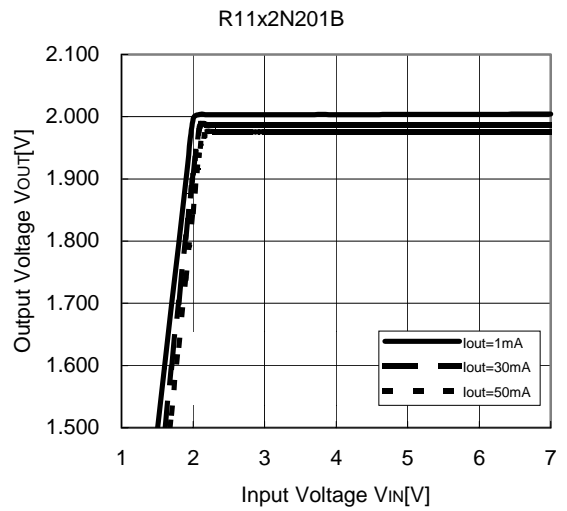
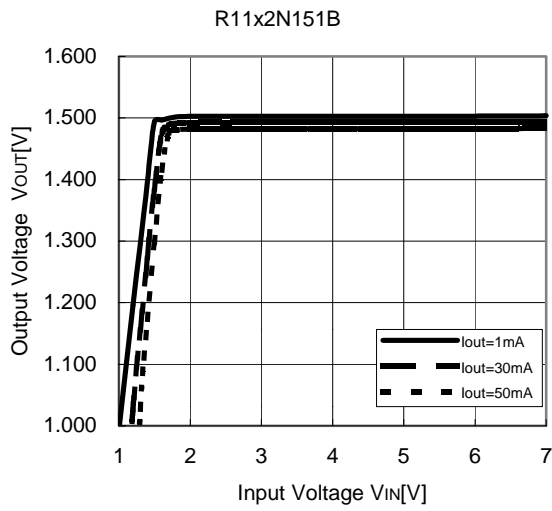

3) Dropout Voltage vs. Output Current

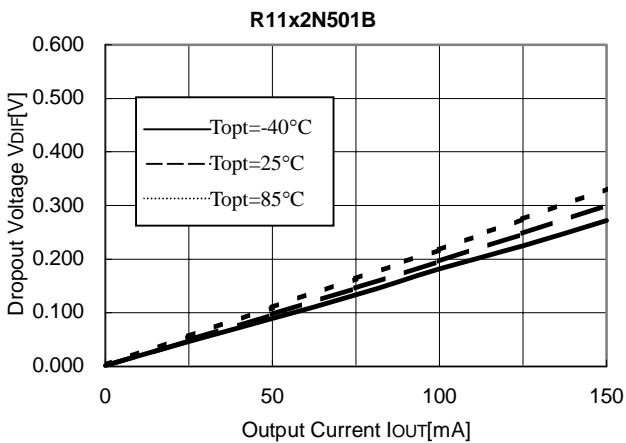
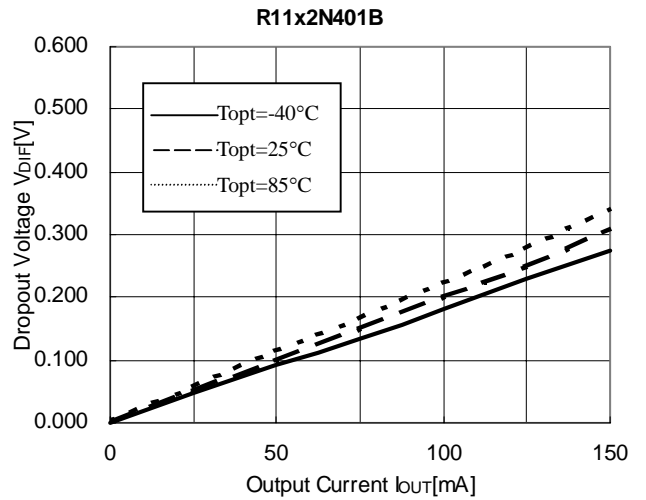
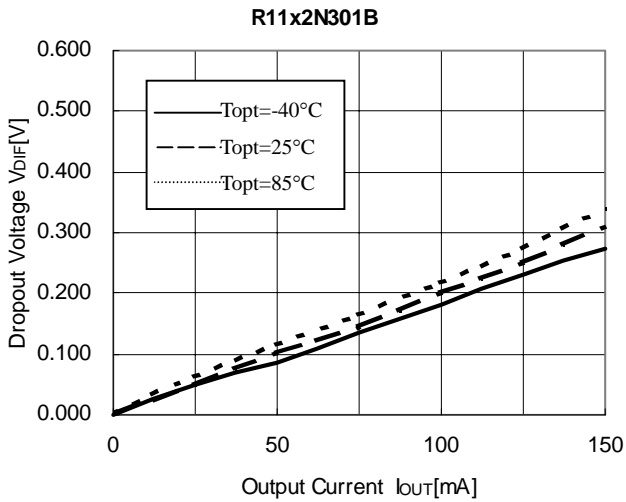
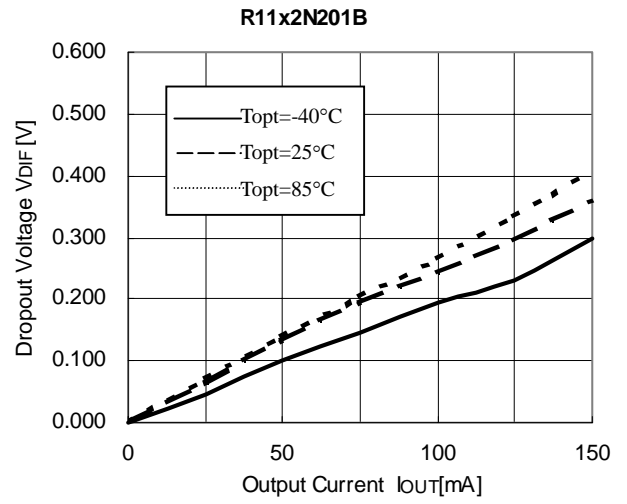
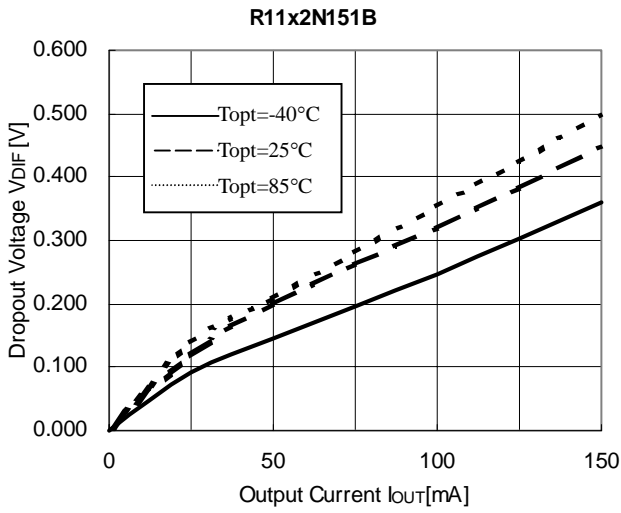

4) Output Voltage vs. Temperature

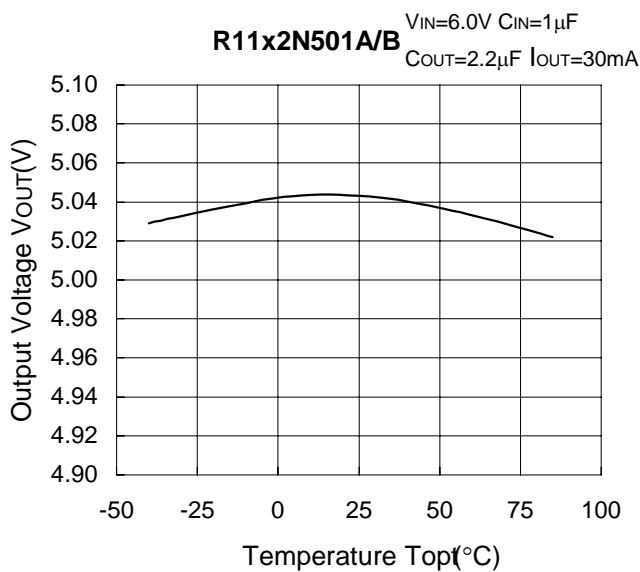
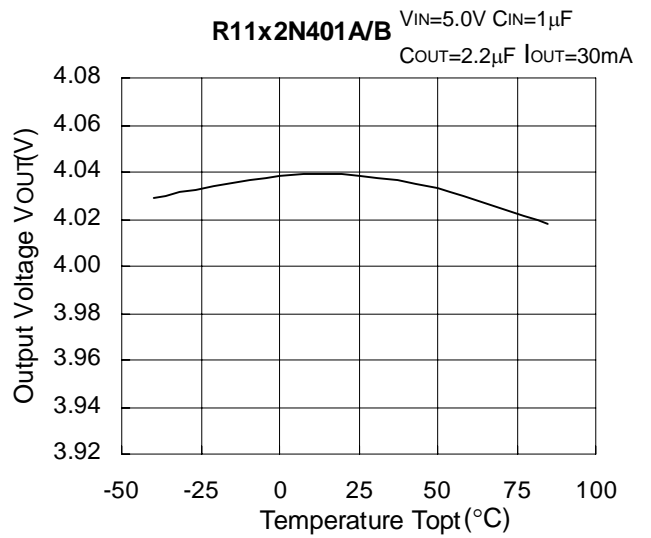
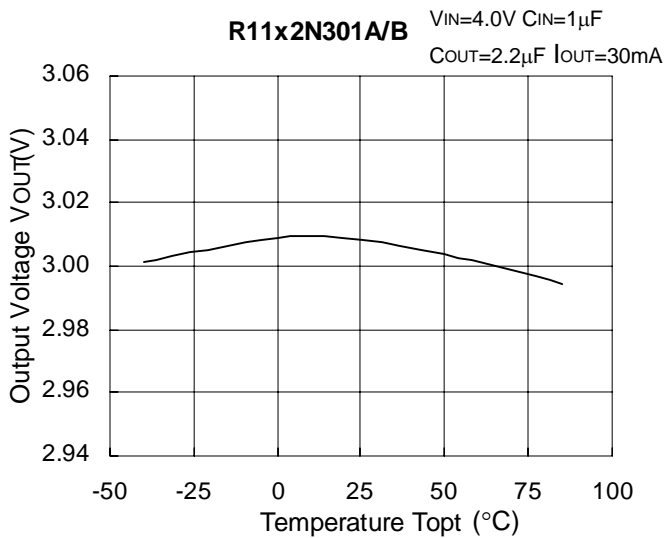
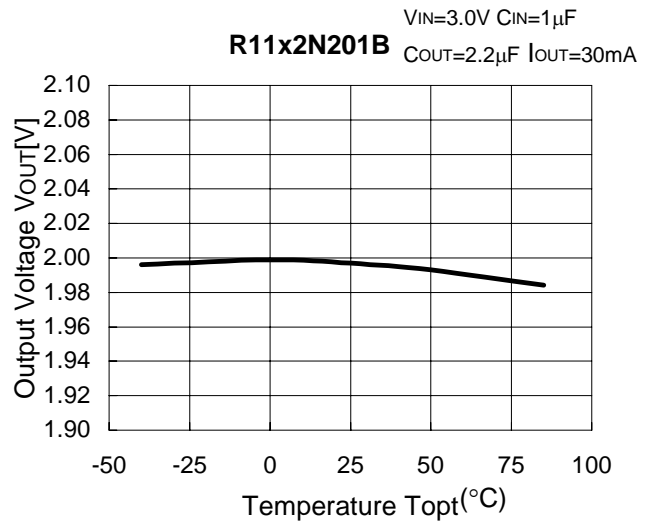
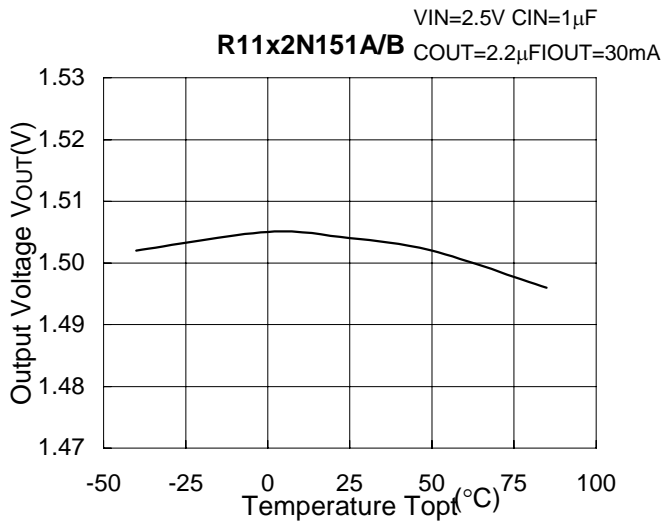

5) Supply Current vs. Input Voltage

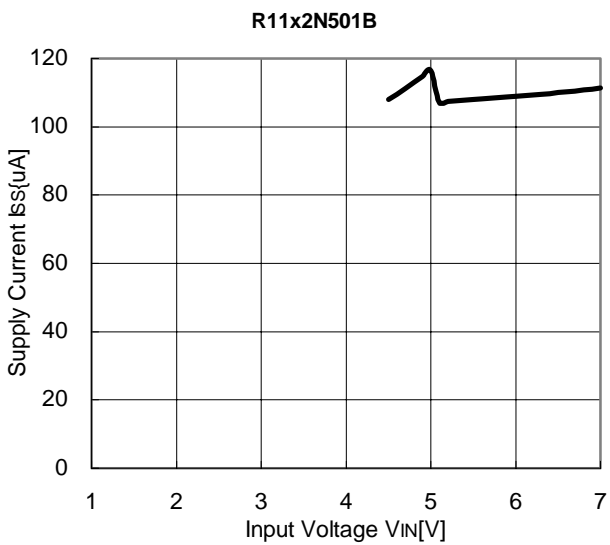
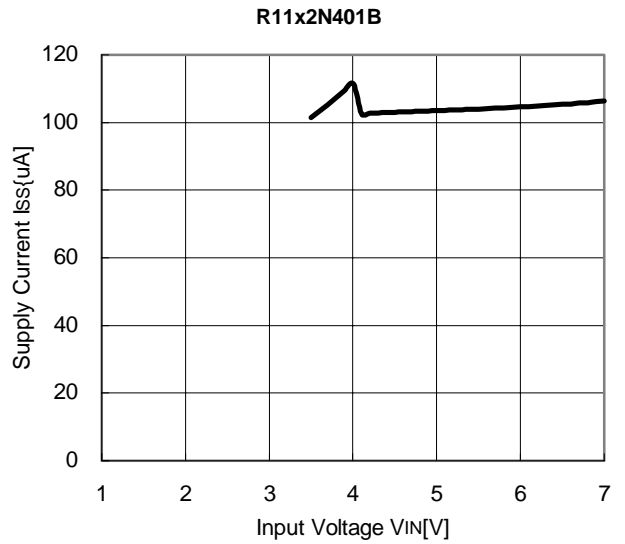
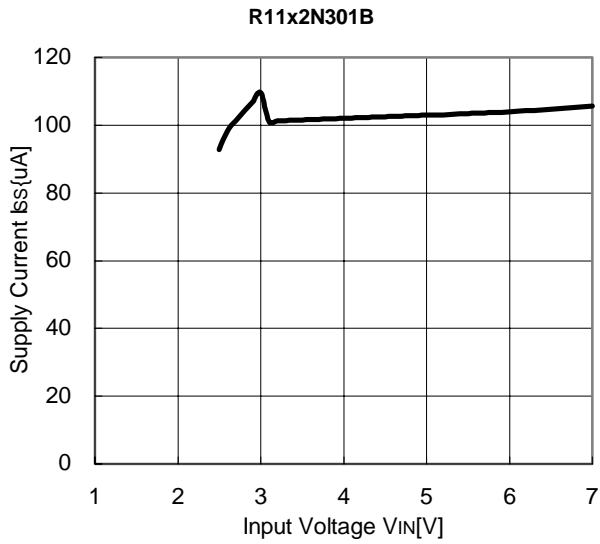
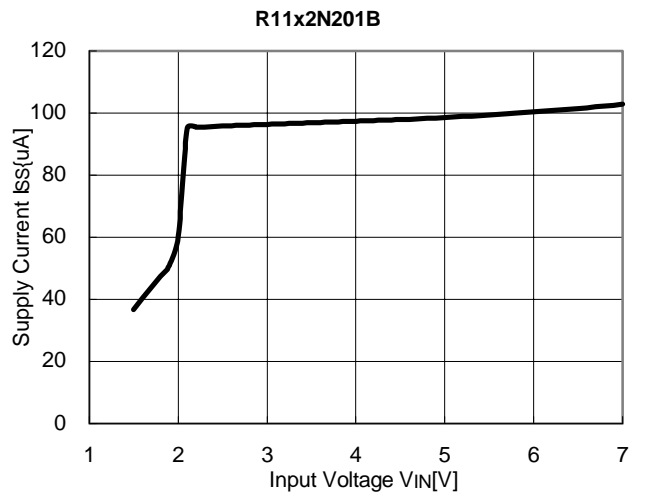
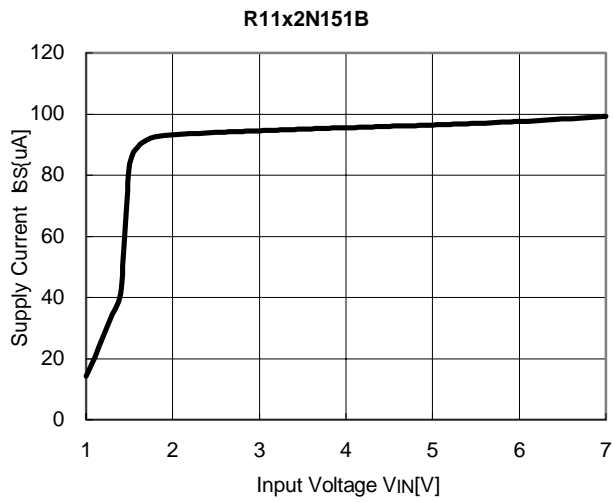

6) Supply Current vs. Temperature

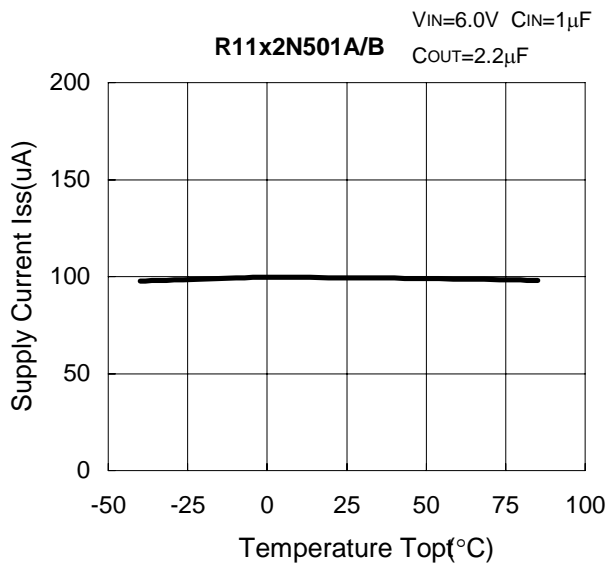
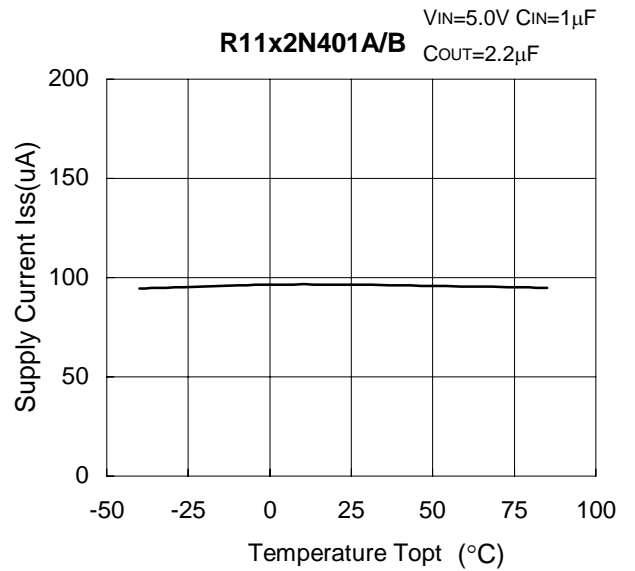
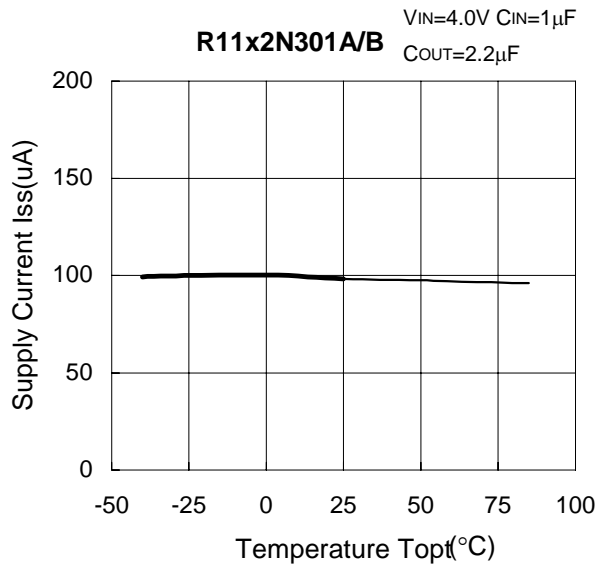
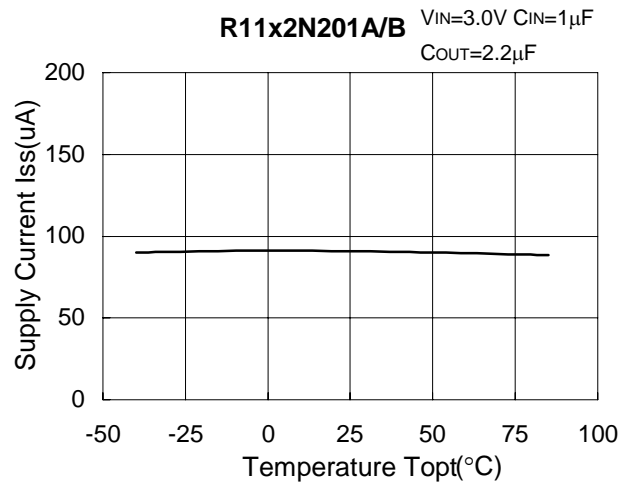
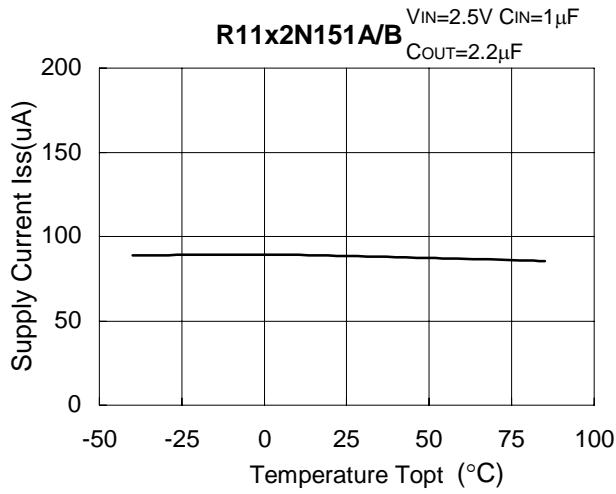

7) Ripple Rejection vs. Frequency

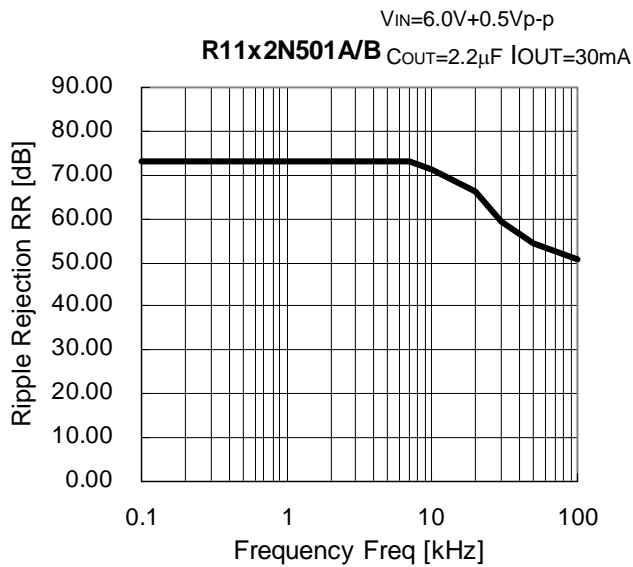
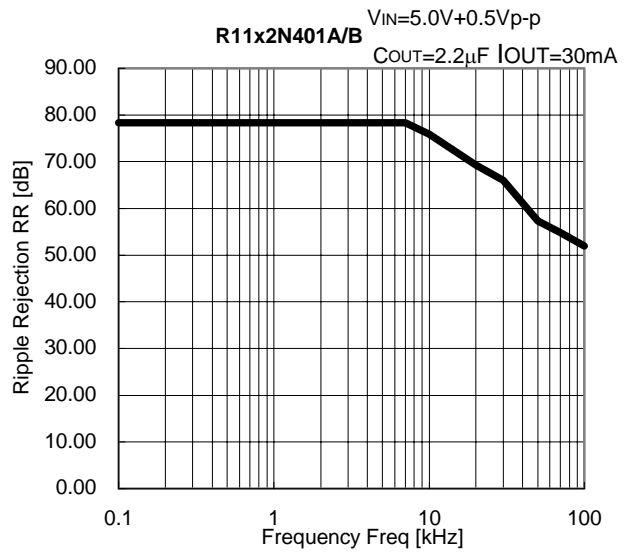
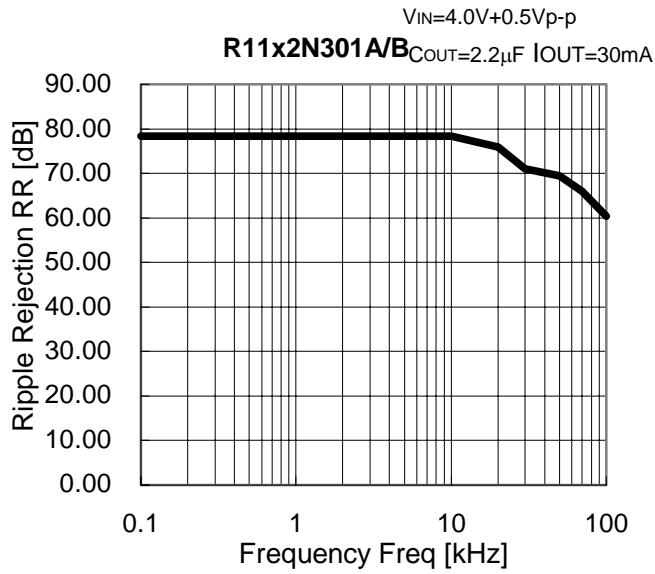
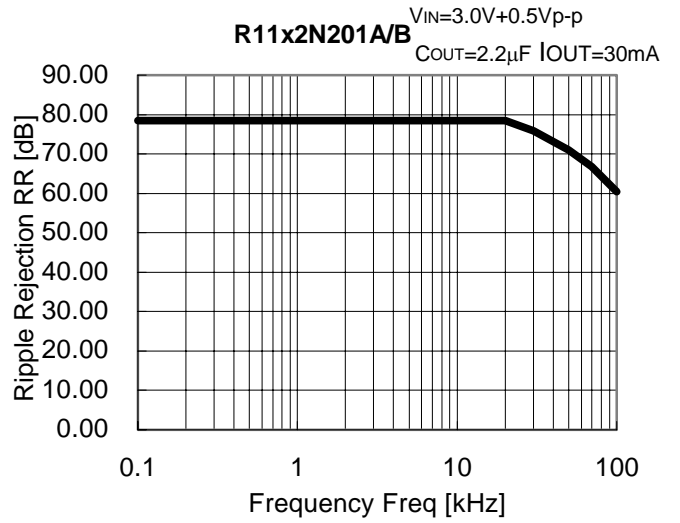
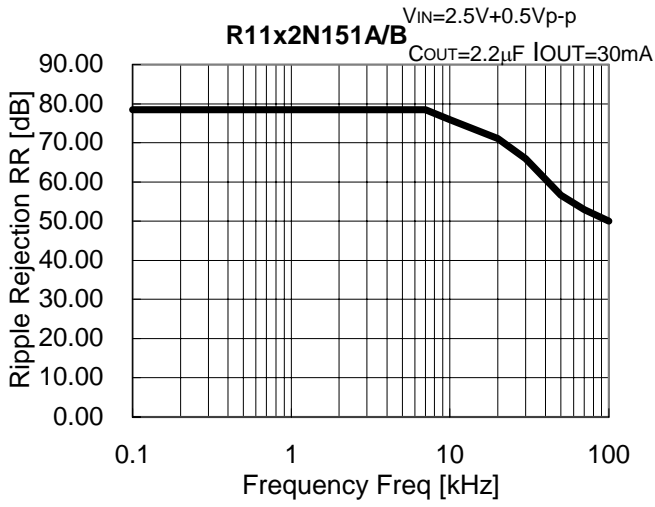

8) Ripple Rejection vs. Input Voltage (DC bias)

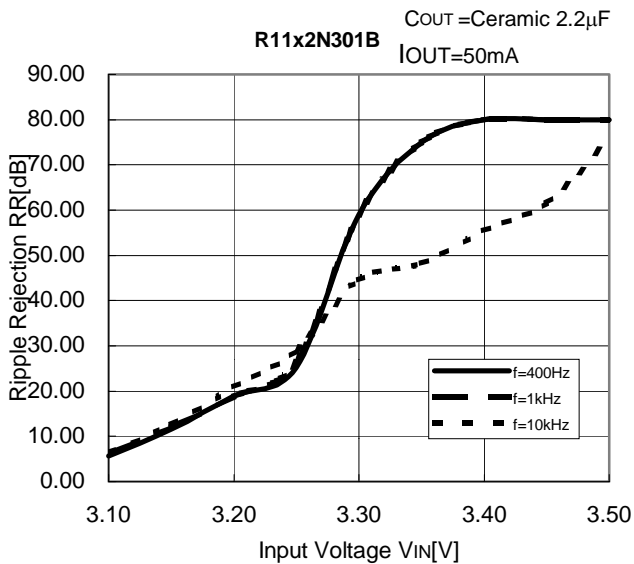
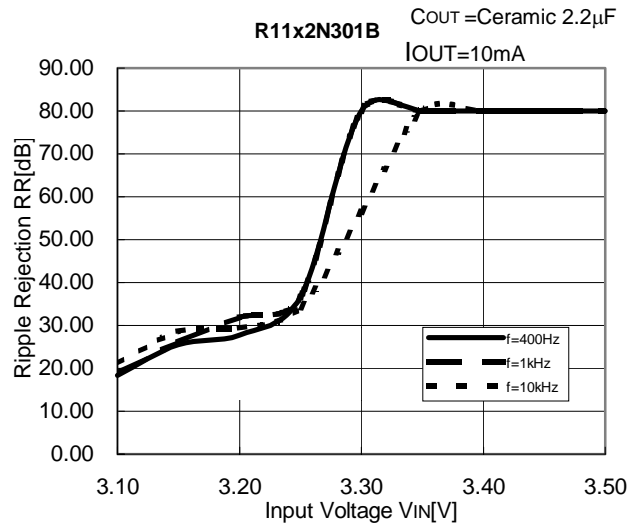
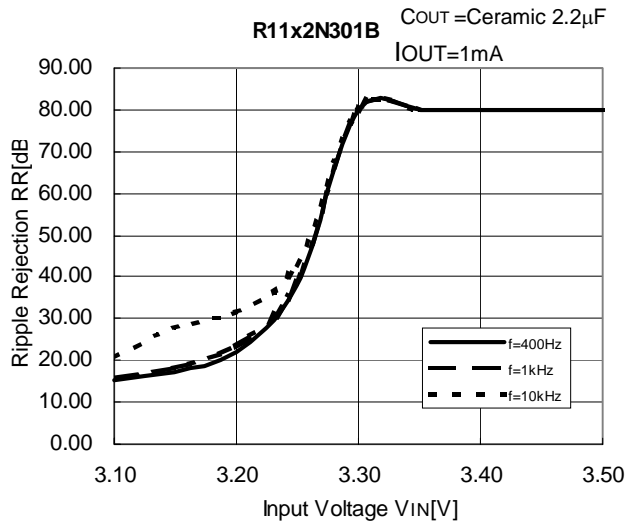

9) Input Transient Response

R11X2N151B

Topt=25°C

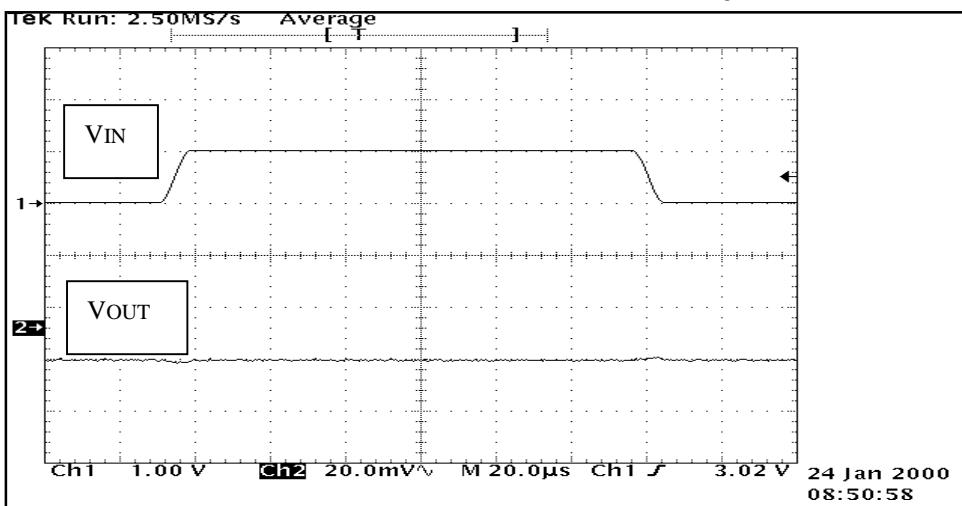

VIN=2.5V<-->3.5V
IOUT=30mA
CIN =none
COUT=2.2μF
tr/tf=5μs

R11X2N201B

Topt=25°C

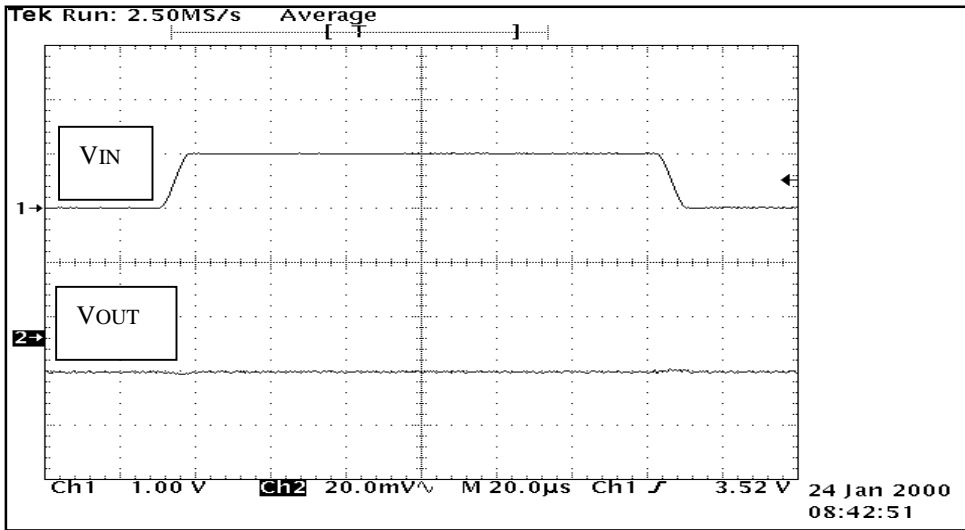

VIN=3.0V<-->4.0V
IOUT=30mA
CIN =none
COUT=2.2µF
tr/tf=5µs

R11X2N301B

Topt=25°C

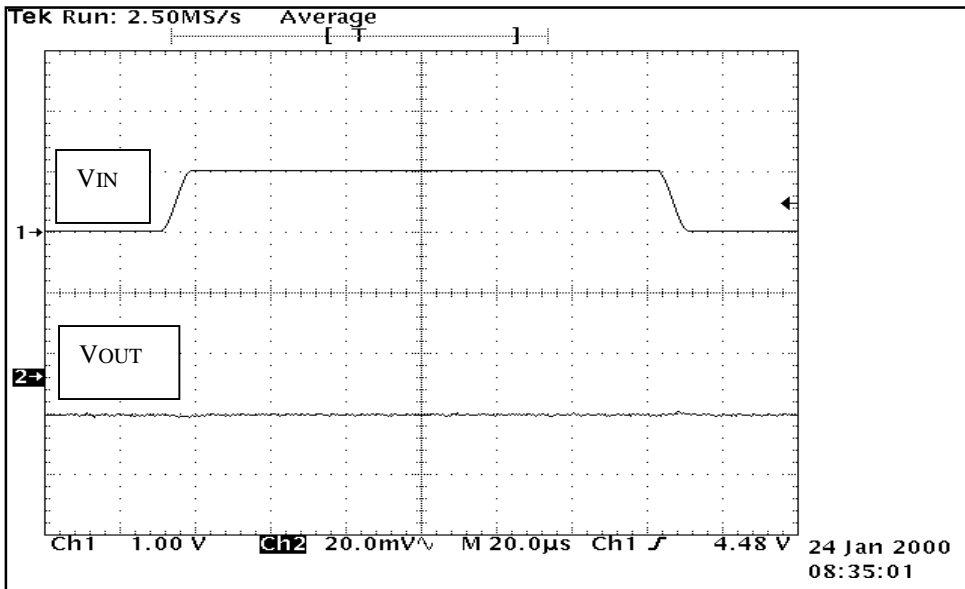

VIN=4.0V<-->5.0V
IOUT=30mA
CIN =none
COUT=2.2µF
tr/tf=5µs

R11X2N401B

Topt=25°C

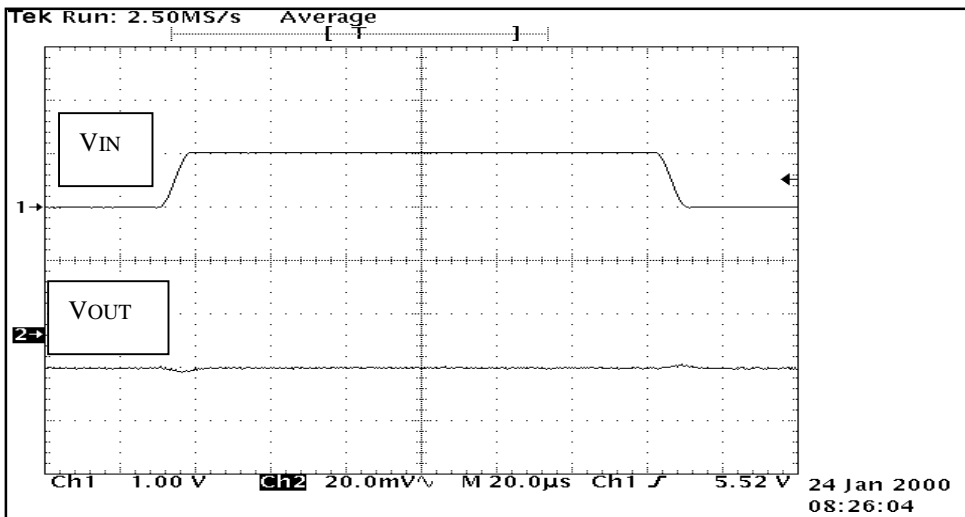

VIN=5.0V<-->6.0V
IOUT=30mA
CIN =none
COUT=2.2µF
tr/tf=5µs

R11X2N501B

Topt=25°C

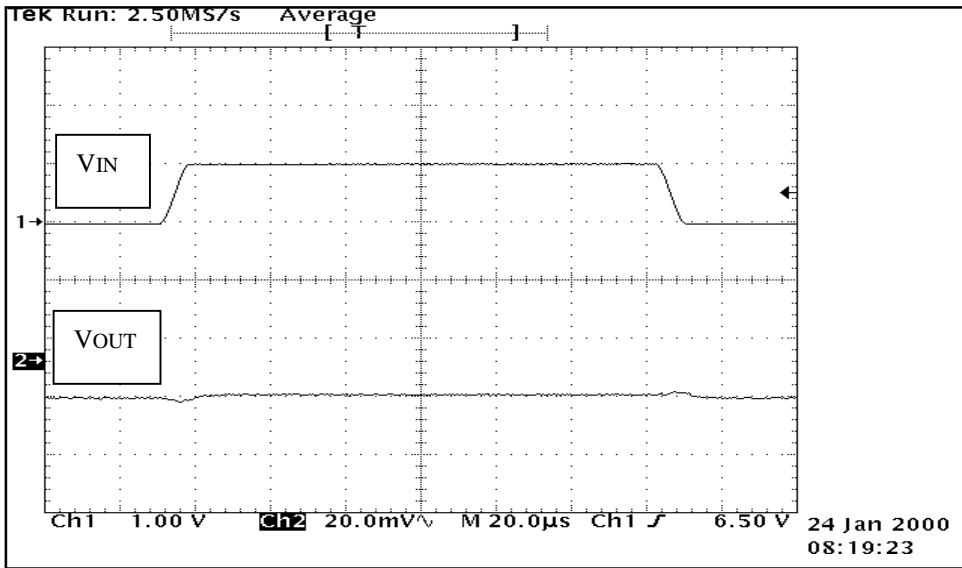

VIN=6.0V<-->7.0V
IOUT=30mA
CIN =none
COUT=2.2µF
tr/tf=5µs

10) Load Transient Response

R11X2N151B

Topt=25°C

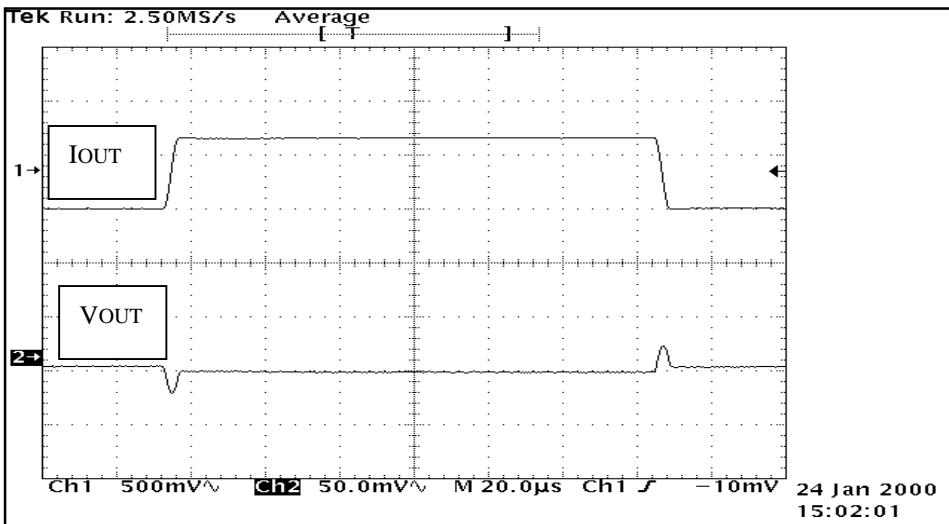

IOUT=50mA<-->100mA
VIN=2.5V
CIN=2.2µF
COUT=2.2µF
tr/tf=5 s

R11X2N201B

Topt=25°C

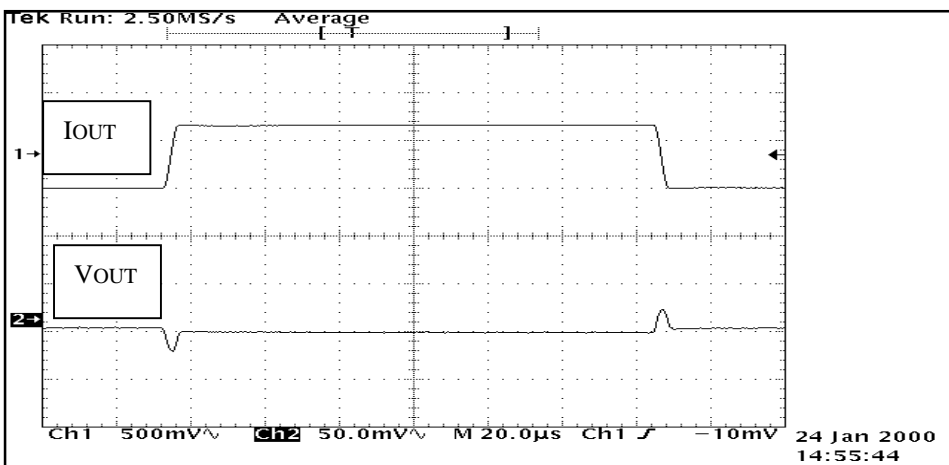

IOUT=50mA<-->100mA
VIN=3.0V
CIN=2.2µF
COUT=2.2µF
tr/tf=5µs

R11X2N301B

Topt=25°C

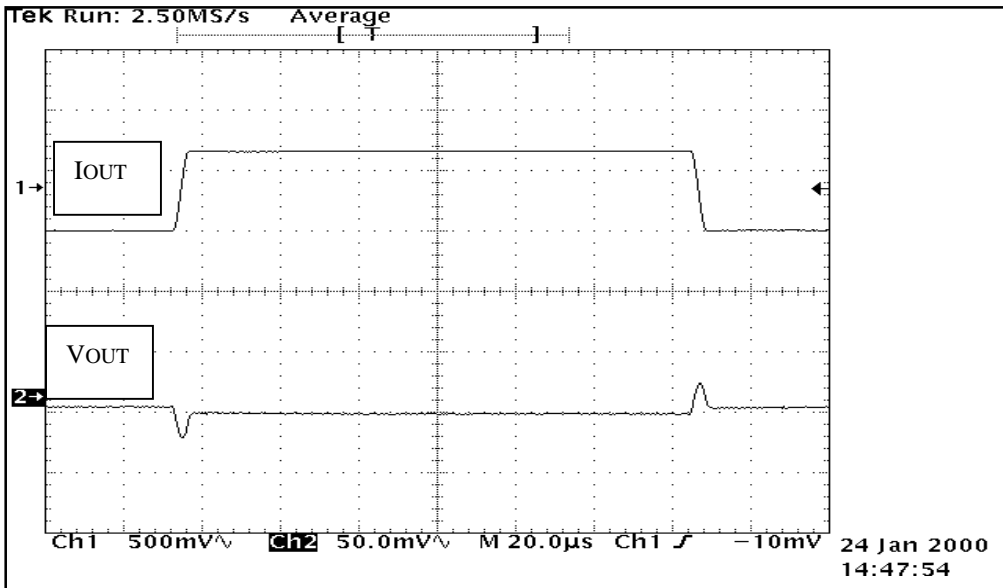

IOUT=50mA<-->100mA
VIN=4.0V
CIN=2.2µF
COUT=2.2µF
tr/tf=5µs

R11X2N401B

Topt=25°C

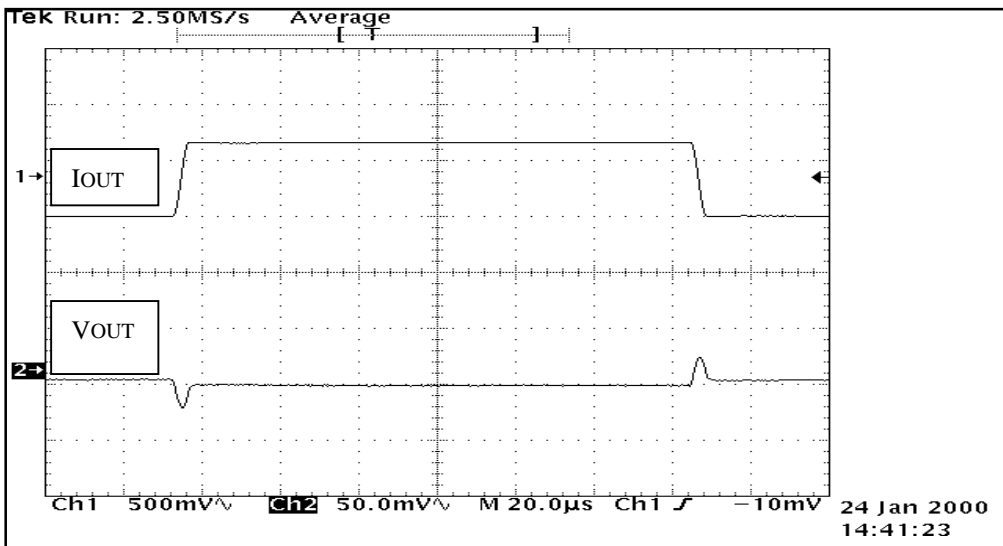

IOUT=50mA<-->100mA
VIN=5.0V
CIN=2.2µF
COUT=2.2µF
tr/tf=5µs

R11X2N501B

Topt=25°C

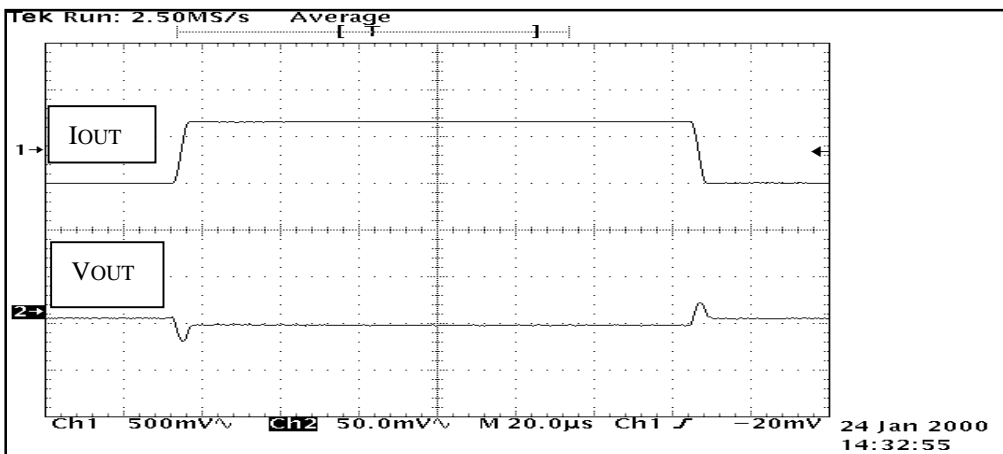

IOUT=50mA<-->100mA
VIN=6.0V
CIN=2.2µF
COUT=2.2µF
tr/tf=5µs

■ TECHNICAL NOTES

When using these ICs, be sure to consider following points:

- Make V_{DD} and GND line sufficient. When the impedance of these is high, there is a case to pick up the noise or not to work correctly.
- Connect the capacitor with a capacitance as much as $2.2\mu\text{F}$ between V_{DD} and GND as close as possible.
- Set external components, especially Output Capacitor, as close as possible to the ICs and make wiring shortest.

In these ICs, phase compensation is made for securing stable operation even if the load current is varied. For this purpose, be sure to use a capacitor C_{OUT} with good frequency characteristics and ESR (Equivalent Series Resistance) of which is in the range described as follows:

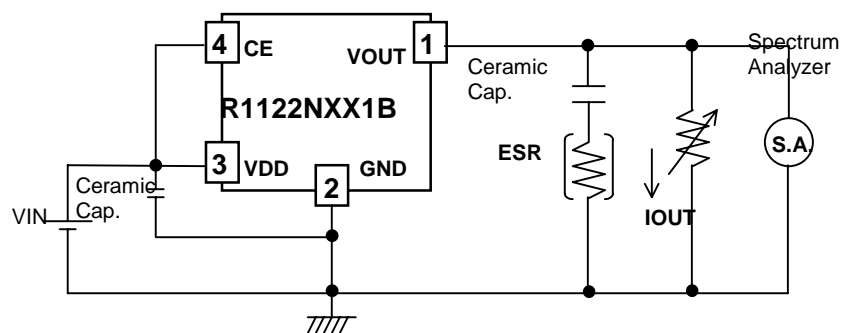

Measuring Circuit for white noise; R1122NXX1B

The relations between I_{OUT} (Output Current) and ESR of Output Capacitor are shown below. The conditions when the white noise level is under $40\mu\text{V}$ (Avg.) are marked as the hatched area in the graph.

(note: When the additional ceramic capacitors are connected to the Output Pin with Output capacitor for phase compensation, the operation might be unstable. Because of this, test these ICs with as same external components as ones to be used on the PCB.)

<measuring conditions>

- (1) $V_{IN} = V_{OUT} + 1\text{V}$
- (2) Frequency band : 10Hz to 1MHz
- (3) Temperature : 25°C

R11X2N151B

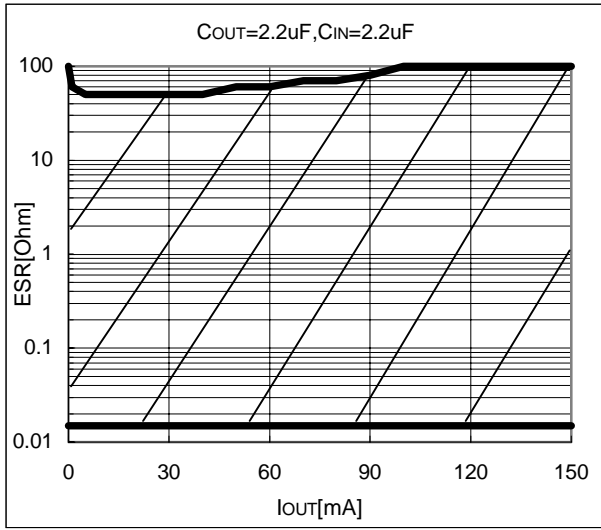

R11X2N151B

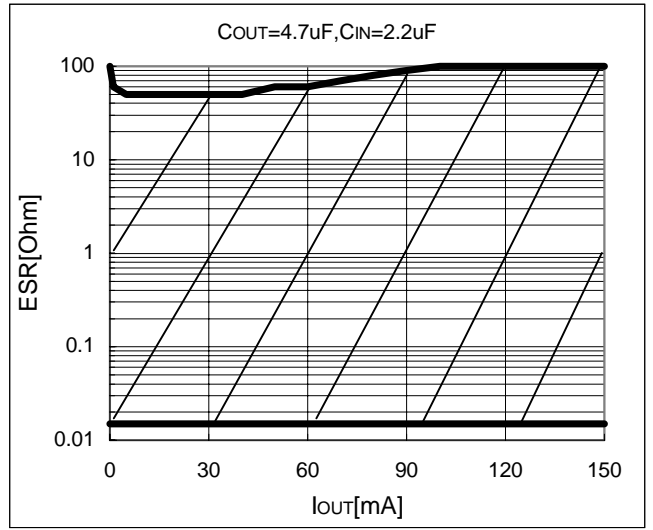

R11X2N301B

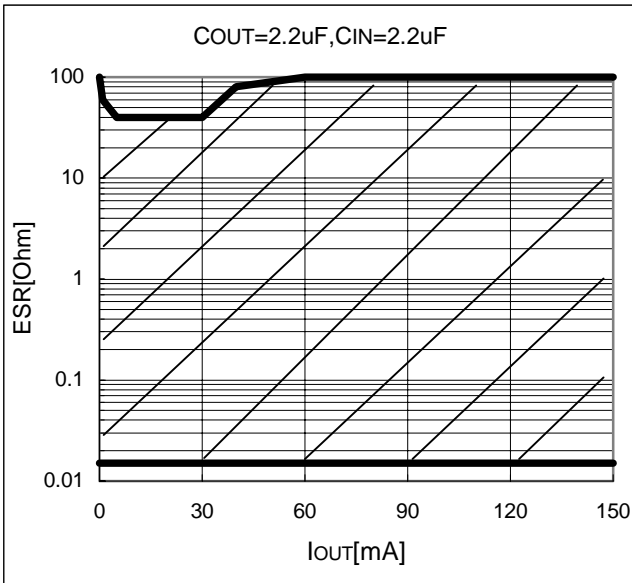

R11X2N301B

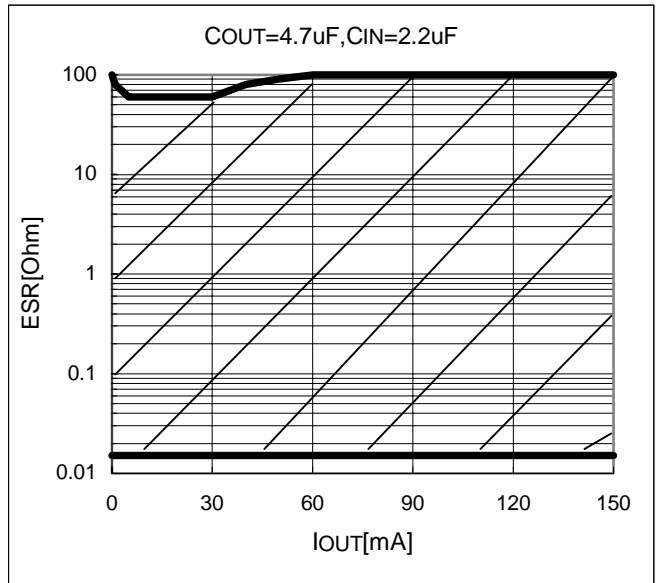



Компания «ЭлектроПласт» предлагает заключение долгосрочных отношений при поставках импортных электронных компонентов на взаимовыгодных условиях!

Наши преимущества:

- Оперативные поставки широкого спектра электронных компонентов отечественного и импортного производства напрямую от производителей и с крупнейших мировых складов;
- Поставка более 17-ти миллионов наименований электронных компонентов;
- Поставка сложных, дефицитных, либо снятых с производства позиций;
- Оперативные сроки поставки под заказ (от 5 рабочих дней);
- Экспресс доставка в любую точку России;
- Техническая поддержка проекта, помощь в подборе аналогов, поставка прототипов;
- Система менеджмента качества сертифицирована по Международному стандарту ISO 9001;
- Лицензия ФСБ на осуществление работ с использованием сведений, составляющих государственную тайну;
- Поставка специализированных компонентов (Xilinx, Altera, Analog Devices, Intersil, Interpoint, Microsemi, Aeroflex, Peregrine, Syfer, Eurofarad, Texas Instrument, Miteq, Cobham, E2V, MA-COM, Hittite, Mini-Circuits, General Dynamics и др.);

Помимо этого, одним из направлений компании «ЭлектроПласт» является направление «Источники питания». Мы предлагаем Вам помощь Конструкторского отдела:

- Подбор оптимального решения, техническое обоснование при выборе компонента;
- Подбор аналогов;
- Консультации по применению компонента;
- Поставка образцов и прототипов;
- Техническая поддержка проекта;
- Защита от снятия компонента с производства.



Как с нами связаться

Телефон: 8 (812) 309 58 32 (многоканальный)

Факс: 8 (812) 320-02-42

Электронная почта: org@eplast1.ru

Адрес: 198099, г. Санкт-Петербург, ул. Калинина, дом 2, корпус 4, литера А.