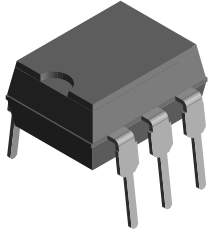
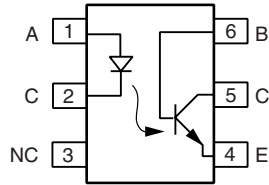


Optocoupler, Phototransistor Output, with Base Connection, 300 V BV_{CEO}



I179004



DESCRIPTION

The SFH 640 is an optocoupler with very high BV_{CER} , a minimum of 300 V. It is intended for telecommunications applications or any DC application requiring a high blocking voltage.

FEATURES

- Good CTR linearity with forward current
- Low CTR degradation
- Very high collector emitter breakdown voltage, $BV_{CER} = 300$ V
- Isolation test voltage: 5300 V_{RMS}
- Low coupling capacitance
- High common mode transient immunity
- Phototransistor optocoupler 6 pin DIP package with base connection
- Lead (Pb)-free component
- Component in accordance to RoHS 2002/95/EC and WEEE 2002/96/EC


RoHS
COMPLIANT

AGENCY APPROVALS

- UL1577, file no. E52744 system code H or J, double protection
- DIN EN 60747-5-2 (VDE 0884)/DIN EN 60747-5-5 pending available with option 1
- CSA 93751
- BSI IEC 60950; IEC 60065

ORDER INFORMATION

PART	REMARKS
SFH640-1	CTR 40 to 80 %, DIP-6
SFH640-2	CTR 63 to 125 %, DIP-6
SFH640-3	CTR 100 to 200 %, DIP-6
SFH640-2X007	CTR 63 to 125 %, SMD-6 (option 7)
SFH640-3X007	CTR 100 to 200 %, SMD-6 (option 7)
SFH640-3X009	CTR 100 to 200 %, SMD-6 (option 9)

Note

For additional information on the available options refer to option information.

ABSOLUTE MAXIMUM RATINGS (1)

PARAMETER	TEST CONDITION	SYMBOL	VALUE	UNIT
INPUT				
Reverse voltage		V_R	6.0	V
DC forward current		I_F	60	mA
Surge forward current	$t_p \leq 10 \mu s$	I_{FSM}	2.5	A
Total power dissipation		P_{diss}	100	mW
OUTPUT				
Collector emitter voltage		V_{CE}	300	V
Collector base voltage		V_{CBO}	300	V
Emitter base voltage		V_{EBO}	7.0	V
Collector current		I_C	50	mA
Surge collector current	$t_p \leq 10 ms$	I_C	100	mA
Total power dissipation		P_{diss}	300	mW

ABSOLUTE MAXIMUM RATINGS (1)				
PARAMETER	TEST CONDITION	SYMBOL	VALUE	UNIT
COUPLER				
Isolation test voltage between emitter and detector, refer to climate DIN 40046, part 2, Nov. 74		V_{ISO}	5300/7500	V_{RMS}/V_{PK}
Isolation resistance	$V_{IO} = 500\text{ V}, T_{amb} = 25\text{ }^{\circ}\text{C}$	R_{IO}	$\geq 10^{12}$	Ω
	$V_{IO} = 500\text{ V}, T_{amb} = 100\text{ }^{\circ}\text{C}$	R_{IO}	$\geq 10^{11}$	Ω
Insulation thickness between emitter and detector			≥ 0.4	mm
Creepage distance			≥ 7	mm
Clearance distance			≥ 7	mm
Comparative tracking index per DIN IEC 112/VDE 0303, part 1		CTI	175	
Storage temperature range		T_{stg}	- 55 to + 150	$^{\circ}\text{C}$
Operating temperature range		T_{amb}	- 55 to + 100	$^{\circ}\text{C}$
Soldering temperature (2)	max. 10 s, dip soldering; distance to seating plane ≥ 1.5 mm	T_{sld}	260	$^{\circ}\text{C}$

Notes

(1) $T_{amb} = 25\text{ }^{\circ}\text{C}$, unless otherwise specified.

Stresses in excess of the absolute maximum ratings can cause permanent damage to the device. Functional operation of the device is not implied at these or any other conditions in excess of those given in the operational sections of this document. Exposure to absolute maximum ratings for extended periods of the time can adversely affect reliability.

(2) Refer to reflow profile for soldering conditions for surface mounted devices (SMD). Refer to wave profile for soldering conditions for through hole devices (DIP).

ELECTRICAL CHARACTERISTICS							
PARAMETER	TEST CONDITION	PART	SYMBOL	MIN.	TYP.	MAX.	UNIT
INPUT							
Forward voltage	$I_F = 10\text{ mA}$		V_V		1.1	1.5	V
Reverse voltage	$I_R = 10\text{ }\mu\text{A}$		V_R	6.0			V
Reverse current	$V_R = 6.0\text{ V}$		I_R		0.01	10	μA
Capacitance	$V_F = 0\text{ V}, f = 1.0\text{ MHz}$		C_O		25		pF
Thermal resistance			R_{thja}		750		K/W
OUTPUT							
Collector emitter breakdown voltage	$I_{CE} = 1.0\text{ mA},$ $R_{BE} = 1.0\text{ M}\Omega$		BV_{CER}	300			V
Voltage emitter base	$I_{EB} = 10\text{ }\mu\text{A}$		BV_{BEO}	7.0			V
Collector emitter capacitance	$V_{CE} = 10\text{ V}, f = 1.0\text{ MHz}$		C_{CE}		7.0		pF
Collector base capacitance	$V_{CB} = 10\text{ V}, f = 1.0\text{ MHz}$		C_{CB}		8.0		pF
Emitter base capacitance	$V_{EB} = 5.0\text{ V}, f = 1.0\text{ MHz}$		C_{EB}		38		pF
Thermal resistance			R_{thja}		250		K/W
COUPLER							
Coupling capacitance			C_C		0.6		pF
Saturation voltage collector emitter	$I_F = 10\text{ mA}, I_C = 2.0\text{ mA}$	SFH640-1	V_{CEsat}		0.25	0.4	V
	$I_F = 10\text{ mA}, I_C = 3.2\text{ mA}$	SFH640-2	V_{CEsat}		0.25	0.4	V
	$I_F = 10\text{ mA}, I_C = 5.0\text{ mA}$	SFH640-3	V_{CEsat}		0.25	0.4	V
Collector emitter leakage current	$V_{CE} = 200\text{ V},$ $R_{BE} = 1.0\text{ M}\Omega$		I_{CER}		1.0	100	nA

Note

$T_{amb} = 25\text{ }^{\circ}\text{C}$, unless otherwise specified.

Minimum and maximum values are testing requirements. Typical values are characteristics of the device and are the result of engineering evaluation. Typical values are for information only and are not part of the testing requirements.

CURRENT TRANSFER RATIO							
PARAMETER	TEST CONDITION	PART	SYMBOL	MIN.	TYP.	MAX.	UNIT
Current transfer ratio	$I_F = 10 \text{ mA}$, $V_{CE} = 10 \text{ V}$	SFH640-1	I_C/I_F	40		80	%
	$I_F = 1.0 \text{ mA}$, $V_{CE} = 10 \text{ V}$	SFH640-1	I_C/I_F	13	30		%
	$I_F = 10 \text{ mA}$, $V_{CE} = 10 \text{ V}$	SFH640-2	I_C/I_F	63		125	%
	$I_F = 1.0 \text{ mA}$, $V_{CE} = 10 \text{ V}$	SFH640-2	I_C/I_F	22	45		%
	$I_F = 10 \text{ mA}$, $V_{CE} = 10 \text{ V}$	SFH640-3	I_C/I_F	100		200	%
	$I_F = 1.0 \text{ mA}$, $V_{CE} = 10 \text{ V}$	SFH640-3	I_C/I_F	34	70		%

SWITCHING CHARACTERISTICS							
PARAMETER	TEST CONDITION	SYMBOL	MIN.	TYP.	MAX.	UNIT	
Turn-on time	$I_C = 2.0 \text{ mA}$, $R_L = 100 \Omega$, $V_{CC} = 10 \text{ V}$	t_{on}		5.0		μs	
Rise time	$I_C = 2.0 \text{ mA}$, $R_L = 100 \Omega$, $V_{CC} = 10 \text{ V}$	t_r		2.5		μs	
Turn-off time	$I_C = 2.0 \text{ mA}$, $R_L = 100 \Omega$, $V_{CC} = 10 \text{ V}$	t_{off}		6.0		μs	
Fall time	$I_C = 2.0 \text{ mA}$, $R_L = 100 \Omega$, $V_{CC} = 10 \text{ V}$	t_f		5.5		μs	

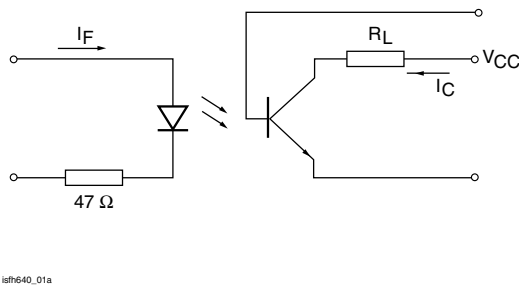
TYPICAL CHARACTERISTICS
 $T_{amb} = 25^\circ\text{C}$, unless otherwise specified


Fig. 1 - Switching Times Measurement Test Circuit and Waveform

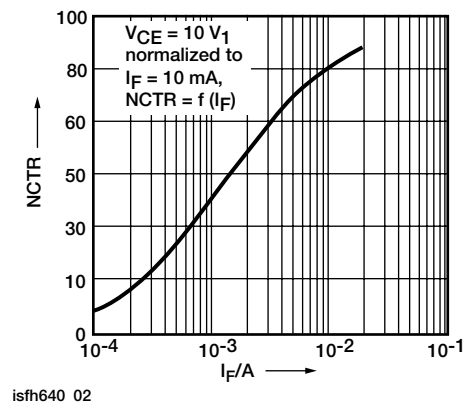


Fig. 3 - Current Transfer Ratio (Typ.)

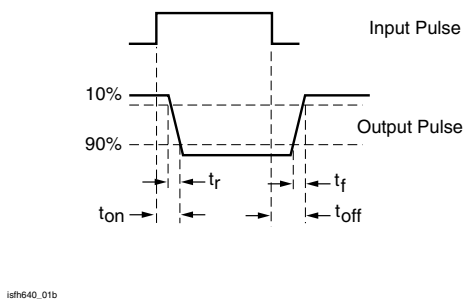


Fig. 2 - Switching Times Measurement Test Circuit and Waveform

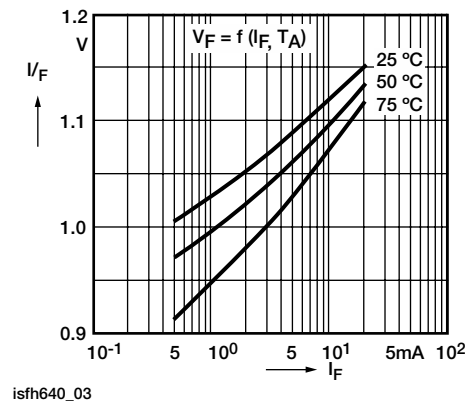


Fig. 4 - Diode Forward Voltage (Ttyp.)

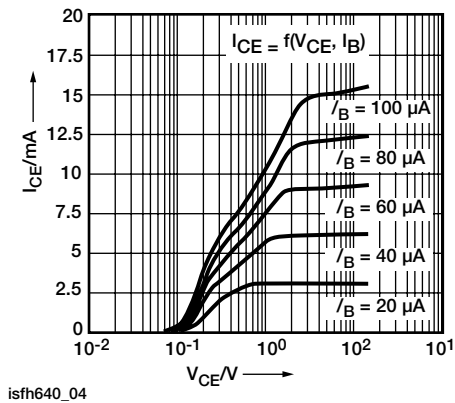


Fig. 5 - Output Characteristics (Typ.)

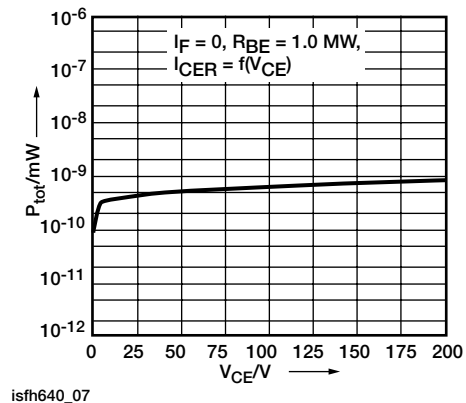


Fig. 8 - Collector-Emitter Leakage Current (Typ.)

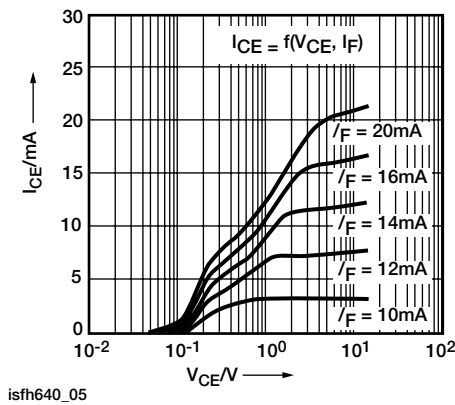


Fig. 6 - Output Characteristics (Typ.)

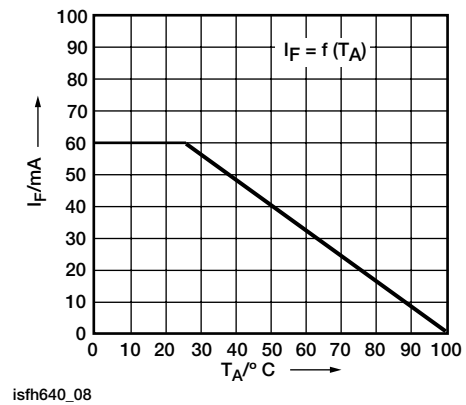


Fig. 9 - Permissible Loss Diode

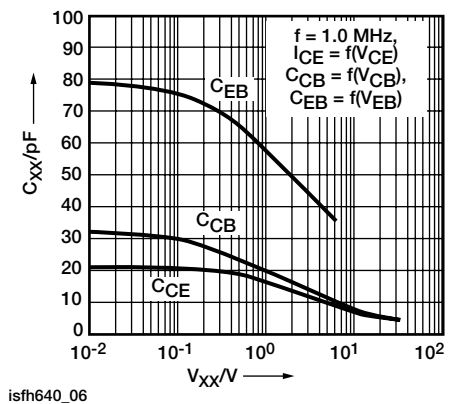


Fig. 7 - Transistor Capacitances (Typ.)

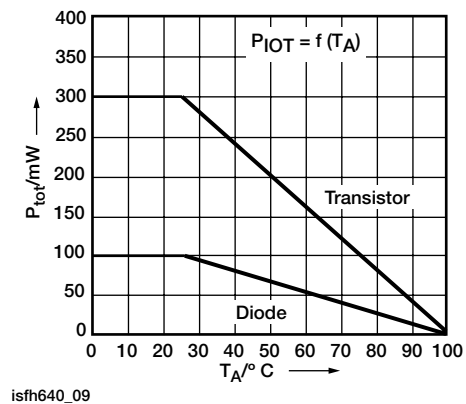
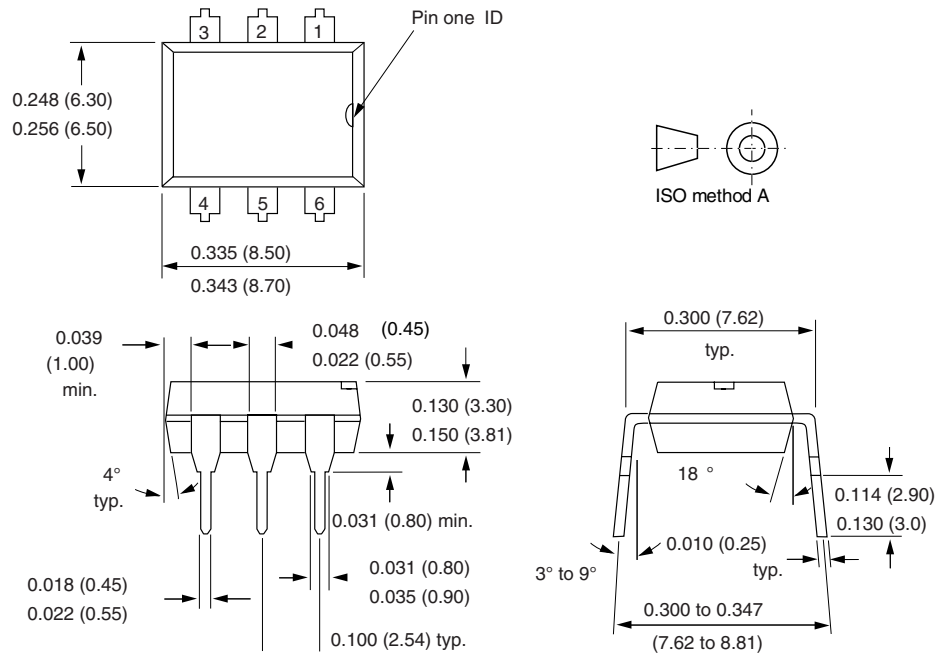


Fig. 10 - Permissible Power Dissipation



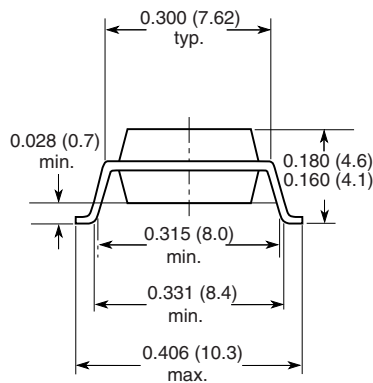
Optocoupler, Phototransistor Output, Vishay Semiconductors
with Base Connection, 300 V V_{CE0}

PACKAGE DIMENSIONS in inches (millimeters)

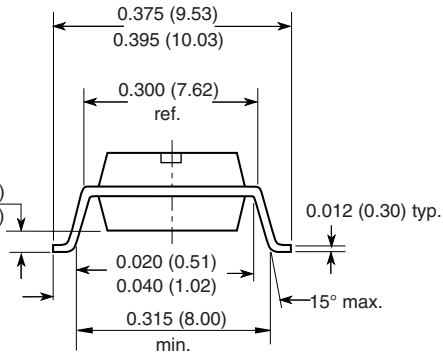


i178004

Option 7



Option 9



18494

OZONE DEPLETING SUBSTANCES POLICY STATEMENT

It is the policy of Vishay Semiconductor GmbH to

1. Meet all present and future national and international statutory requirements.
2. Regularly and continuously improve the performance of our products, processes, distribution and operating systems with respect to their impact on the health and safety of our employees and the public, as well as their impact on the environment.

It is particular concern to control or eliminate releases of those substances into the atmosphere which are known as ozone depleting substances (ODSs).

The Montreal Protocol (1987) and its London Amendments (1990) intend to severely restrict the use of ODSs and forbid their use within the next ten years. Various national and international initiatives are pressing for an earlier ban on these substances.

Vishay Semiconductor GmbH has been able to use its policy of continuous improvements to eliminate the use of ODSs listed in the following documents.

1. Annex A, B and list of transitional substances of the Montreal Protocol and the London Amendments respectively.
2. Class I and II ozone depleting substances in the Clean Air Act Amendments of 1990 by the Environmental Protection Agency (EPA) in the USA.
3. Council Decision 88/540/EEC and 91/690/EEC Annex A, B and C (transitional substances) respectively.

Vishay Semiconductor GmbH can certify that our semiconductors are not manufactured with ozone depleting substances and do not contain such substances.

We reserve the right to make changes to improve technical design
and may do so without further notice.

Parameters can vary in different applications. All operating parameters must be validated for each customer application by the customer. Should the buyer use Vishay Semiconductors products for any unintended or unauthorized application, the buyer shall indemnify Vishay Semiconductors against all claims, costs, damages, and expenses, arising out of, directly or indirectly, any claim of personal damage, injury or death associated with such unintended or unauthorized use.

Vishay Semiconductor GmbH, P.O.B. 3535, D-74025 Heilbronn, Germany



Disclaimer

All product specifications and data are subject to change without notice.

Vishay Intertechnology, Inc., its affiliates, agents, and employees, and all persons acting on its or their behalf (collectively, "Vishay"), disclaim any and all liability for any errors, inaccuracies or incompleteness contained herein or in any other disclosure relating to any product.

Vishay disclaims any and all liability arising out of the use or application of any product described herein or of any information provided herein to the maximum extent permitted by law. The product specifications do not expand or otherwise modify Vishay's terms and conditions of purchase, including but not limited to the warranty expressed therein, which apply to these products.

No license, express or implied, by estoppel or otherwise, to any intellectual property rights is granted by this document or by any conduct of Vishay.

The products shown herein are not designed for use in medical, life-saving, or life-sustaining applications unless otherwise expressly indicated. Customers using or selling Vishay products not expressly indicated for use in such applications do so entirely at their own risk and agree to fully indemnify Vishay for any damages arising or resulting from such use or sale. Please contact authorized Vishay personnel to obtain written terms and conditions regarding products designed for such applications.

Product names and markings noted herein may be trademarks of their respective owners.



Компания «ЭлектроПласт» предлагает заключение долгосрочных отношений при поставках импортных электронных компонентов на взаимовыгодных условиях!

Наши преимущества:

- Оперативные поставки широкого спектра электронных компонентов отечественного и импортного производства напрямую от производителей и с крупнейших мировых складов;
- Поставка более 17-ти миллионов наименований электронных компонентов;
- Поставка сложных, дефицитных, либо снятых с производства позиций;
- Оперативные сроки поставки под заказ (от 5 рабочих дней);
- Экспресс доставка в любую точку России;
- Техническая поддержка проекта, помощь в подборе аналогов, поставка прототипов;
- Система менеджмента качества сертифицирована по Международному стандарту ISO 9001;
- Лицензия ФСБ на осуществление работ с использованием сведений, составляющих государственную тайну;
- Поставка специализированных компонентов (Xilinx, Altera, Analog Devices, Intersil, Interpoint, Microsemi, Aeroflex, Peregrine, Syfer, Eurofarad, Texas Instrument, Miteq, Cobham, E2V, MA-COM, Hittite, Mini-Circuits, General Dynamics и др.);

Помимо этого, одним из направлений компании «ЭлектроПласт» является направление «Источники питания». Мы предлагаем Вам помощь Конструкторского отдела:

- Подбор оптимального решения, техническое обоснование при выборе компонента;
- Подбор аналогов;
- Консультации по применению компонента;
- Поставка образцов и прототипов;
- Техническая поддержка проекта;
- Защита от снятия компонента с производства.



Как с нами связаться

Телефон: 8 (812) 309 58 32 (многоканальный)

Факс: 8 (812) 320-02-42

Электронная почта: org@eplast1.ru

Адрес: 198099, г. Санкт-Петербург, ул. Калинина, дом 2, корпус 4, литера А.