

THIS DRAWING IS UNPUBLISHED. RELEASED FOR PUBLICATION 20
 © COPYRIGHT 20 BY - ALL RIGHTS RESERVED.

LOC	DIST	REVISIONS					
FT	0	P	LTR	DESCRIPTION	DATE	DWN	APVD
		C2		REVISED PER ECO-11-005027	18MAR2011	RK	HMR
		C3		NEW P/N 5-1546105-4 ADDED	17OCT2017	FP	FP

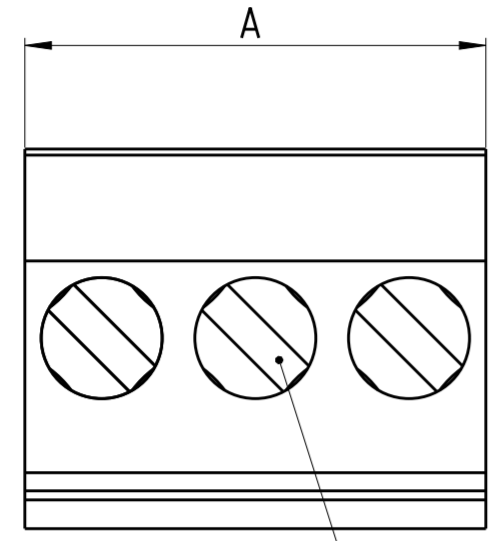

- 1 MATERIALS AND FINISH
 HOUSING: PA 6-6, UL 94-V0, COLOR: BLACK.
 CLAMP: BRASS, NICKEL PLATED.
 CONTACT SPRING : PHOSPHOR BRONZE, FINISH: SEE TABLE.
 CLAMPING SCREW: M3, BRASS, NICKEL PLATED.
- 2. WIRE SIZE RANGE: 12 - 30 AWG
- 3 NOT CUMULATIVE TOLERANCE.
- 4. INK MARKING: WHITE COLOR.

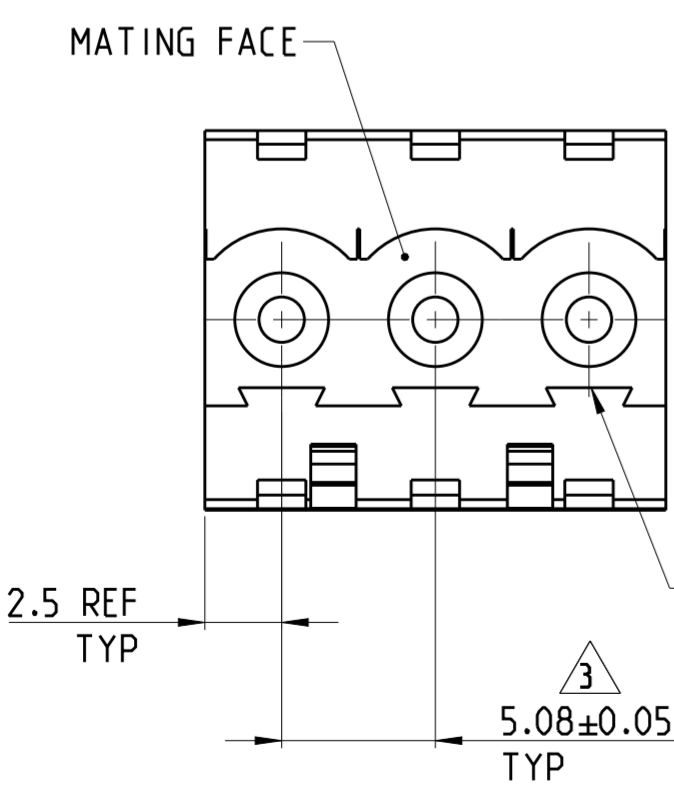
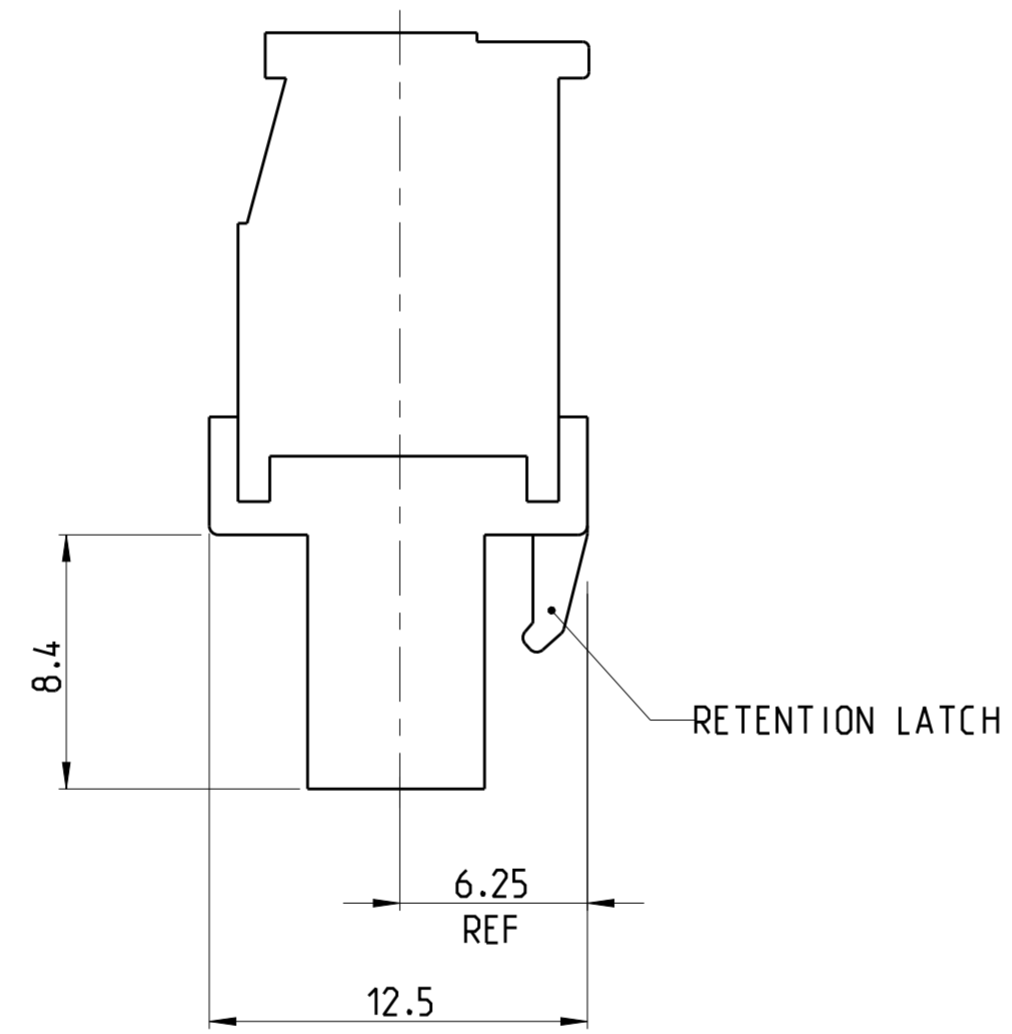
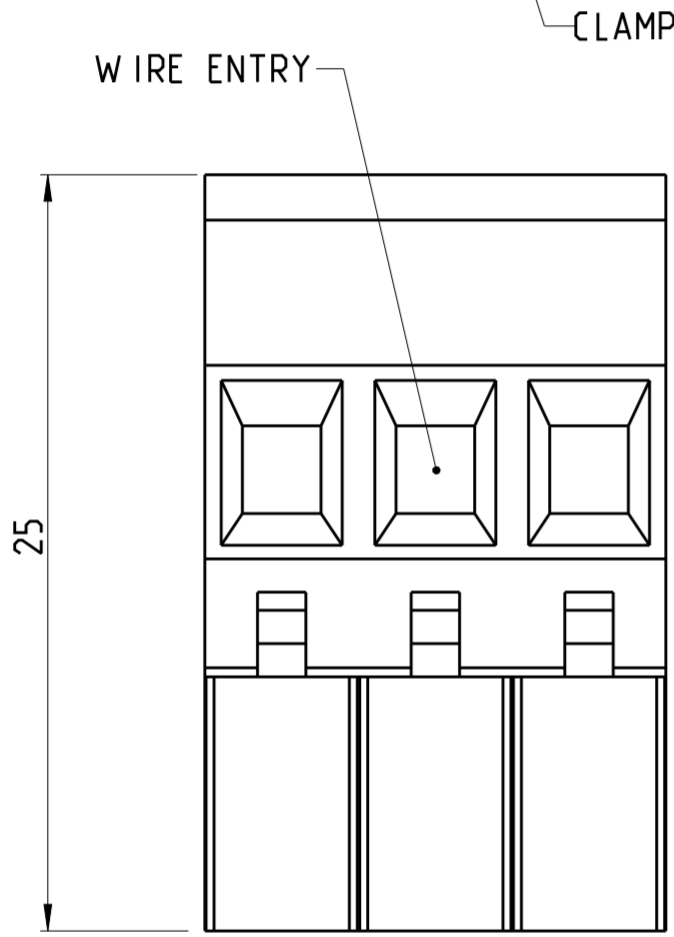

PRELIMINARY	SEE DETAIL Z	TIN	20.32	4	5-1546105-4
PRELIMINARY	SEE DETAIL X	TIN	60.96	12	6-1546105-0
PRELIMINARY	-	.762 μm GOLD	50.80	10	5-1546105-9
PRELIMINARY	-	.762 μm GOLD	40.64	8	5-1546105-8
PRELIMINARY	-	.762 μm GOLD	35.56	7	5-1546105-7
	SEE DETAIL W	TIN	60.96	12	5-1546105-6
PRELIMINARY	SEE DETAIL V	TIN	76.20	15	5-1546105-5
PRELIMINARY	SEE DETAIL U	TIN	45.72	9	4-1546105-9
PRELIMINARY	SEE DETAIL T	TIN	40.64	8	4-1546105-8
PRELIMINARY	SEE DETAIL S	TIN	30.48	6	4-1546105-6
PRELIMINARY	SEE DETAIL R	TIN	20.32	4	4-1546105-4
PRELIMINARY	SEE DETAIL P	TIN	50.80	10	4-1546105-0
PRELIMINARY	SEE DETAIL N	TIN	30.48	6	3-1546105-6
PRELIMINARY	SEE DETAIL M	TIN	25.40	5	3-1546105-5
PRELIMINARY	SEE DETAIL L	TIN	20.32	4	3-1546105-4
PRELIMINARY	SEE DETAIL K	TIN	66.04	13	3-1546105-3
PRELIMINARY	SEE DETAIL J	TIN	50.80	10	3-1546105-0
-	-	TIN	127.00	25	2-1546105-5
-	-	TIN	121.92	24	2-1546105-4
-	-	TIN	116.84	23	2-1546105-3
-	-	TIN	111.76	22	2-1546105-2
-	-	TIN	106.68	21	2-1546105-1
-	-	TIN	101.60	20	2-1546105-0
-	-	TIN	96.52	19	1-1546105-9
-	-	TIN	91.44	18	1-1546105-8
-	-	TIN	86.36	17	1-1546105-7
-	-	TIN	81.28	16	1-1546105-6
-	-	TIN	76.20	15	1-1546105-5
-	-	TIN	71.12	14	1-1546105-4
-	-	TIN	66.04	13	1-1546105-3
-	-	TIN	60.96	12	1-1546105-2
-	-	TIN	55.88	11	1-1546105-1
-	-	TIN	50.80	10	1-1546105-0
-	-	TIN	45.72	9	1546105-9
-	-	TIN	40.64	8	1546105-8
-	-	TIN	35.56	7	1546105-7
-	-	TIN	30.48	6	1546105-6
-	-	TIN	25.40	5	1546105-5
-	-	TIN	20.32	4	1546105-4
-	-	TIN	15.24	3	1546105-3
-	-	TIN	10.16	2	1546105-2
MARKING		CONTACT FINISH	A	NO OF POSN	PART NUMBER

THIS DRAWING IS A CONTROLLED DOCUMENT. DWN S.WELDON 03SEP2002
 CHK C.RICHARD 03SEP2002
 APVD C.RICHARD 03SEP2002

STE TE Connectivity

NAME: TERMINAL BLOCK VERTICAL PLUG
 STACKING LEFT HAND
 5.08mm PITCH

SIZE: A2 CAGE CODE: 00779 DRAWING NO: C-1546105 RESTRICTED TO: -

MATERIAL: 1 TOLERANCES UNLESS OTHERWISE SPECIFIED: 1

0 PLC ±0.3
 1 PLC ±0.25
 2 PLC ±
 3 PLC ±
 4 PLC ±
 ANGLES ±2°
 FINISH

PRODUCT SPEC: -
 APPLICATION SPEC: -
 WEIGHT: -

CUSTOMER DRAWING SCALE: 4:1 SHEET 1 OF 2 REV: C3

THIS DRAWING IS UNPUBLISHED. RELEASED FOR PUBLICATION 20
 © COPYRIGHT 20 BY - ALL RIGHTS RESERVED.

LOC	DIST	REVISIONS					
FT	0	P	LTR	DESCRIPTION	DATE	DWN	APVD
		-		SEE SHEET 1	-	-	-

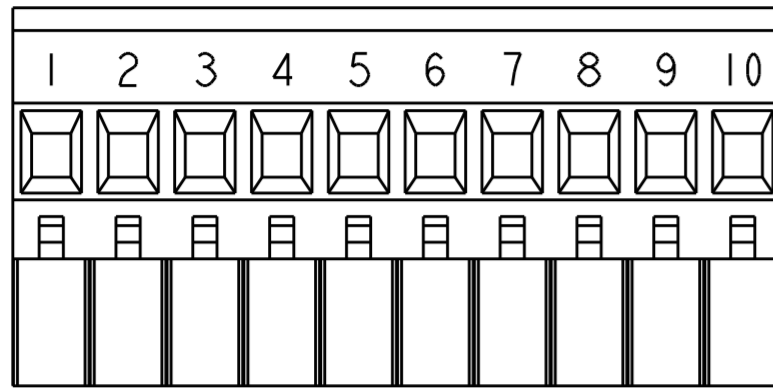

DETAIL J
SCALE 2:1

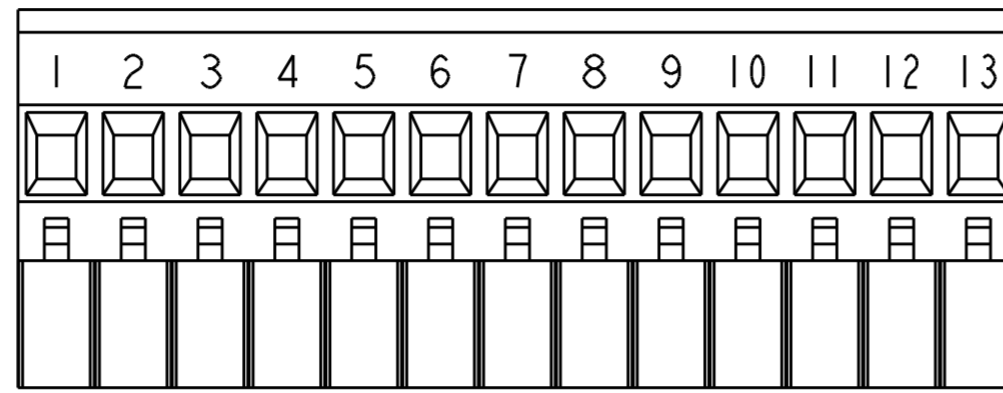

DETAIL K
SCALE 2:1

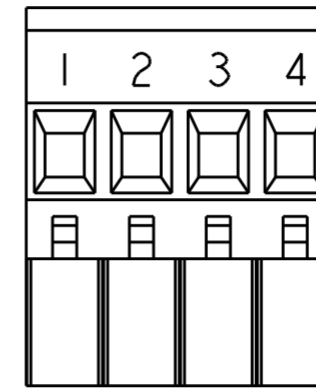

DETAIL L
SCALE 2:1

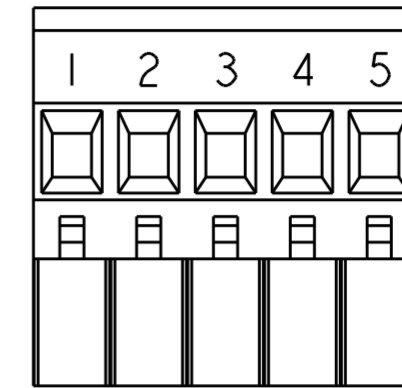

DETAIL M
SCALE 2:1

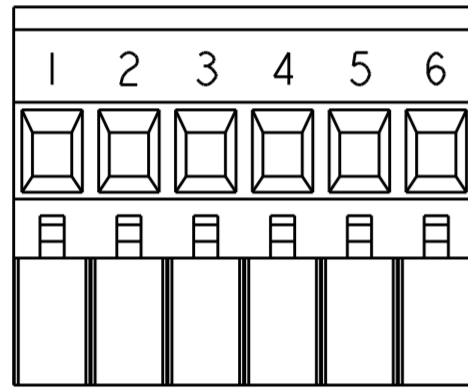

DETAIL N
SCALE 2:1

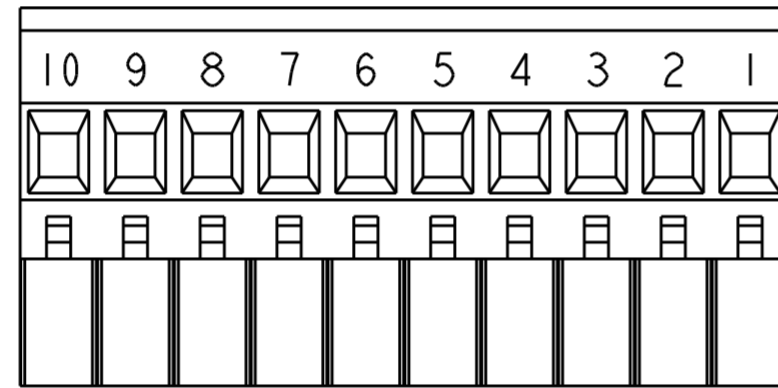

DETAIL P
SCALE 2:1

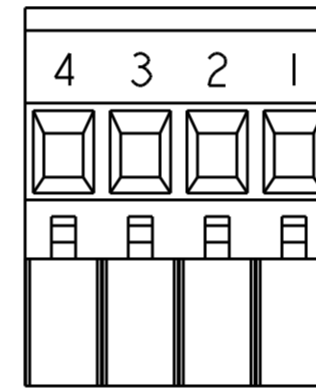

DETAIL R
SCALE 2:1

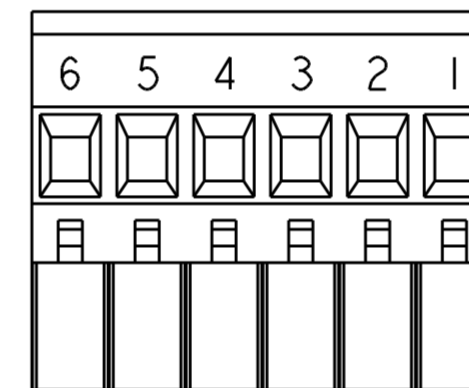

DETAIL S
SCALE 2:1

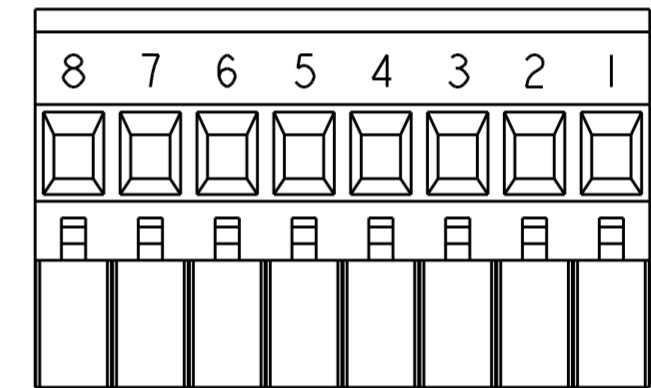

DETAIL T
SCALE 2:1

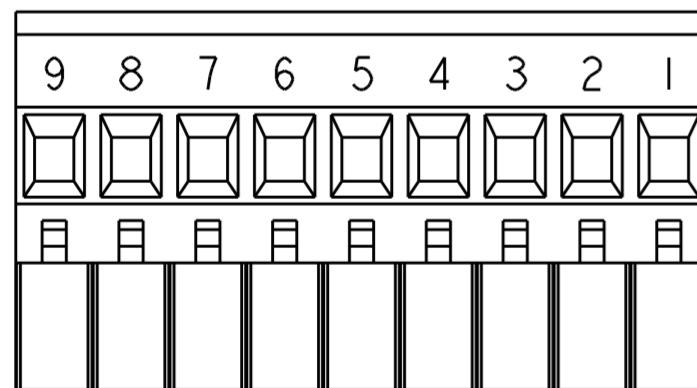

DETAIL U
SCALE 2:1

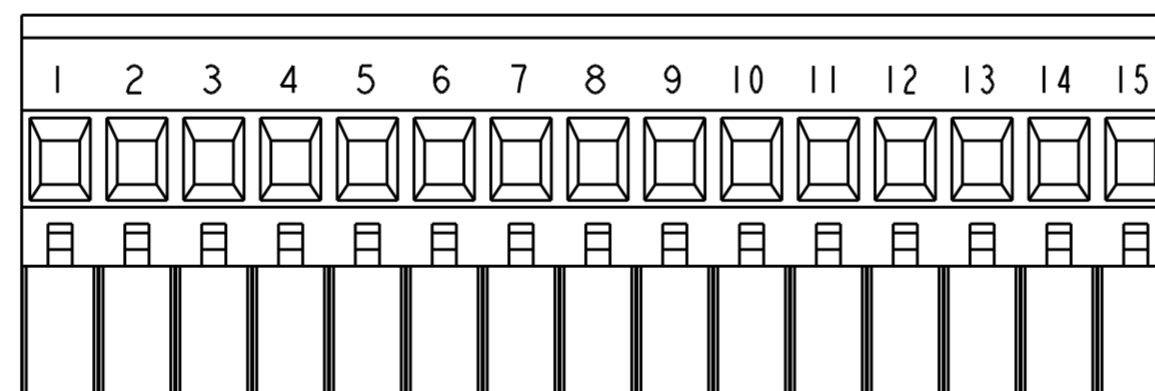

DETAIL V
SCALE 2:1

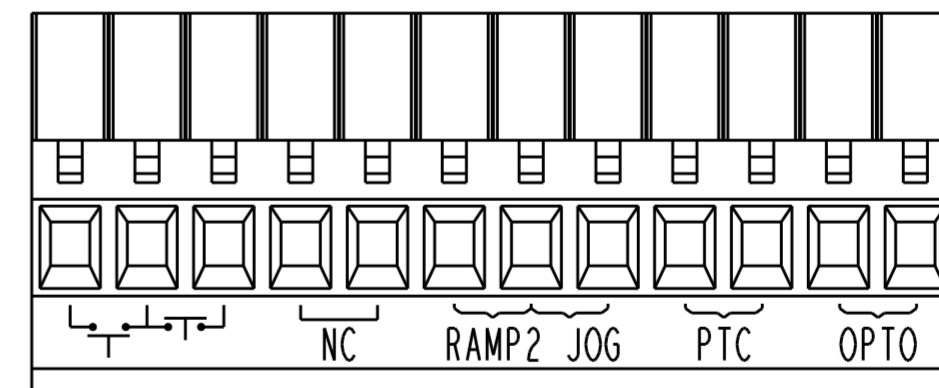

DETAIL W
SCALE 2:1

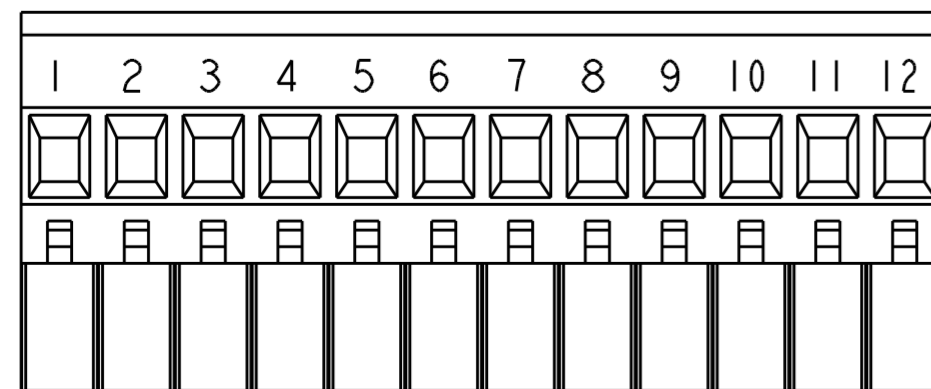

DETAIL X
SCALE 2:1

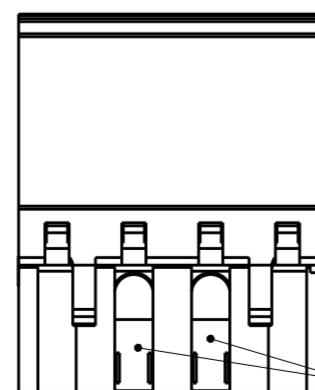

DETAIL Z
SCALE 2:1

CODING KEYS

THIS DRAWING IS A CONTROLLED DOCUMENT.		DWN S.WELDON 03SEP2002	TE Connectivity
DIMENSIONS: mm		CHK C.RICHARD 03SEP2002	
TOLERANCES UNLESS OTHERWISE SPECIFIED: 0 PLC ±0.3 1 PLC ±0.25 2 PLC ± 3 PLC ± 4 PLC ± ANGLES ±2° FINISH		APVD C.RICHARD 03SEP2002	
MATERIAL		PRODUCT SPEC	NAME
		APPLICATION SPEC	TERMINAL BLOCK VERTICAL PLUG STACKING LEFT HAND 5.08mm PITCH
		WEIGHT	SIZE
		CUSTOMER DRAWING	A2 00779
		SCALE 3:1	DRAWING NO C-1546105
		SHEET 2 OF 2	RESTRICTED TO
		REV C3	



Компания «ЭлектроПласт» предлагает заключение долгосрочных отношений при поставках импортных электронных компонентов на взаимовыгодных условиях!

Наши преимущества:

- Оперативные поставки широкого спектра электронных компонентов отечественного и импортного производства напрямую от производителей и с крупнейших мировых складов;
- Поставка более 17-ти миллионов наименований электронных компонентов;
- Поставка сложных, дефицитных, либо снятых с производства позиций;
- Оперативные сроки поставки под заказ (от 5 рабочих дней);
- Экспресс доставка в любую точку России;
- Техническая поддержка проекта, помощь в подборе аналогов, поставка прототипов;
- Система менеджмента качества сертифицирована по Международному стандарту ISO 9001;
- Лицензия ФСБ на осуществление работ с использованием сведений, составляющих государственную тайну;
- Поставка специализированных компонентов (Xilinx, Altera, Analog Devices, Intersil, Interpoint, Microsemi, Aeroflex, Peregrine, Syfer, Eurofarad, Texas Instrument, Miteq, Cobham, E2V, MA-COM, Hittite, Mini-Circuits, General Dynamics и др.);

Помимо этого, одним из направлений компании «ЭлектроПласт» является направление «Источники питания». Мы предлагаем Вам помощь Конструкторского отдела:

- Подбор оптимального решения, техническое обоснование при выборе компонента;
- Подбор аналогов;
- Консультации по применению компонента;
- Поставка образцов и прототипов;
- Техническая поддержка проекта;
- Защита от снятия компонента с производства.



Как с нами связаться

Телефон: 8 (812) 309 58 32 (многоканальный)

Факс: 8 (812) 320-02-42

Электронная почта: org@eplast1.ru

Адрес: 198099, г. Санкт-Петербург, ул. Калинина, дом 2, корпус 4, литера А.