

### GENERAL SPECIFICATIONS

#### Electrical Capacity

**Resistive Load:** HS13: 6A @ 125V AC, 3A @ 250V AC, or 5A @ 30V DC  
 HS16: 12A @ 125V AC or 6A @ 250V AC  
 TS: 6A @ 125/250V AC  
 PS: 30A @ 125/250V AC

#### Other Ratings

**Contact Resistance:** 10 milliohms maximum  
**Insulation Resistance:** 200 megohms minimum @ 500V DC  
**Dielectric Strength:** 1,500V AC minimum for 1 minute minimum  
**Mechanical Life:** HS: 15,000 operations minimum  
 TS: 30,000 operations minimum  
 PS: 10,000 operations minimum  
**Electrical Life:** HS: 7,500 operations minimum  
 TS: 10,000 operations minimum  
 PS: 5,000 operations minimum  
**Indexing:** 30° for HS16, TS & PS; 45° for HS13  
**Contact Timing:** Nonshorting HS13; Shorting & Nonshorting HS16; Nonshorting TS; Nonshorting PS  
**Range of Operating Torque:** HS16: 0.54 ~ 0.64Nm for first pole & 0.05Nm for each additional pole  
 HS13: 0.15 ~ 0.24Nm  
 TS: 0.09Nm for first pole & (0.07Nm x total number of poles) + 0.13Nm for additional poles  
 PS: 0.14Nm for each pole

#### Materials & Finishes

**Knob:** Phenolic resin  
**Shaft:** HS13: brass; HS16, TS, & PS: brass with nickel plating  
**Bushing:** HS13: brass; HS16, TS, & PS: brass with nickel plating  
**Case:** Phenolic resin  
**Movable Contacts:** HS13, HS16, & TS phosphor bronze; PS silver alloy  
**Stationary Contacts:** HS13, HS16, & PS: brass with silver plating; TS: phosphor bronze  
**Terminals:** HS: phosphor bronze; TS & PS: copper with silver plating

#### Environmental Data

**Operating Temp Range:** -10°C through +70°C (+14°F through +158°F)  
**Humidity:** 90 ~ 98% humidity for 96 hours @ 40°C (104°F)  
**Vibration:** 10 ~ 55 Hz with peak-to-peak amplitude of 1.5mm traversing the frequency range & returning in 1 minute; 3 right angled directions for 2 hours  
**Shock:** 50G (490m/s<sup>2</sup>) acceleration (tested in 3 right angled directions, with 3 shocks in each direction)

#### Installation

**Mounting Torque:** 2.94Nm (26 lb•in)  
**Maximum Panel Thickness:** Shown with panel cutouts in following drawings  
**Soldering Time & Temperature:** Manual Soldering (HS series only): See Profile A in Supplement section.

#### Standards & Certifications

**UL:** **File No. E44145 - Recognized only when ordered with marking on switch.**  
 Add "/U" or "/CUL" to end of part number to order UL recognized switch.  
 HS16 models 1- through 6-pole are recognized at 12A @ 125V AC & 6A @ 250V AC  
 See Supplement section to find UL or cULus rating details.

## Standard Size Rotaries

### 6 AMP SINGLE POLE/NONSHORTING/45° INDEXING

Round Shaft	D-flat Shaft	Number of Positions	Stopper Settings	Number of Terminals *	Load Terminals	Schematics		
						HS13X	HS13Y	HS13Z
HS13X	HS13X-D	2	Fixed	1 COM, 2 LOAD	1 & 2			
HS13Y	HS13Y-D	3	Fixed	1 COM, 3 LOAD	1, 2, & 3			
HS13Z	HS13Z-D	4	Fixed	1 COM, 4 LOAD	1, 2, 3, & 4			

Switch is viewed from shaft end and shown in position 1. Terminal numbers are not on switch. Standard Hardware shown on last page of this section.

\* Wire harness & cable assemblies offered only in Americas.



### 12 AMP/SHORTING & NONSHORTING/30° INDEXING

Knurled Shaft		D-flat Shaft		Pole	Number of Positions	Stopper Settings	Number of Terminals *	Schematic
Nonshorting	Shorting	Nonshorting	Shorting					
HS16-1	HS16-1S	HS16-1N	HS16-1SN	1P	2-11	2, 3, 4 . . . 11	1 COM, 11 LOAD	
HS16-2	HS16-2S	HS16-2N	HS16-2SN	2P	2-11	2, 3, 4 . . . 11	2 COM, 22 LOAD	
HS16-3	HS16-3S	HS16-3N	HS16-3SN	3P	2-11	2, 3, 4 . . . 11	3 COM, 33 LOAD	
HS16-4	HS16-4S	HS16-4N	HS16-4SN	4P	2-11	2, 3, 4 . . . 11	4 COM, 44 LOAD	
HS16-5	HS16-5S	HS16-5N	HS16-5SN	5P	2-11	2, 3, 4 . . . 11	5 COM, 55 LOAD	
HS16-6	HS16-6S	HS16-6N	HS16-6SN	6P	2-11	2, 3, 4 . . . 11	6 COM, 66 LOAD	

Switch is viewed from shaft end and shown in position 1. Terminal numbers are not on switch. Standard Hardware shown on last page of this section.

\* Wire harness & cable assemblies offered only in Americas.



### 6 AMP/NONSHORTING/ADJUSTABLE STOP/30° INDEXING

Model	Pole	Number of Positions	Stopper Settings	Number of Terminals	Shaft Type	Schematic
TS1N	1P	2-11	2, 3, 4 . . . 11	1 COM, 11 LOAD	D Flat	 <p>On each deck of multipole devices common &amp; load terminals are in the same positions as shown in this schematic.</p> <p>Switch is viewed from the shaft end and shown in position 1.</p> <p>Terminal numbers are on the switch bottom. Stopper positions are molded on the top of the switch.</p>
TS2N	2P	2-11	2, 3, 4 . . . 11	2 COM, 22 LOAD	D Flat	
TS3N	3P	2-11	2, 3, 4 . . . 11	3 COM, 33 LOAD	D Flat	
TS4N	4P	2-11	2, 3, 4 . . . 11	4 COM, 44 LOAD	D Flat	
TS5N	5P	2-11	2, 3, 4 . . . 11	5 COM, 55 LOAD	D Flat	

• Standard Hardware shown on last page of this section.

#### Panel Cutouts



Maximum Effective Panel Thickness  
 With Locking Ring .189" (4.8mm)  
 Without Locking Ring .228" (5.8mm)

#### Top



#### Bottom



TS5N



Toggles

Rockers

Pushbuttons

Illuminated PB

Programmable

Keylocks

Rotaries

Slides

Tactiles

Tilt

Touch

Indicators

Accessories

Supplement

30 AMP/NONSHORTING/ADJUSTABLE STOP/30° INDEXING

Knurled Shaft	D Flat Shaft	Pole	Number of Positions	Stopper Settings	Number of Terminals	Schematic
PS1	PS1N	1P	2-11	2, 3, 4 . . . 11	1 COM, 11 LOAD	
PS2	PS2N	2P	2-11	2, 3, 4 . . . 11	2 COM, 22 LOAD	
PS3	PS3N	3P	2-11	2, 3, 4 . . . 11	3 COM, 33 LOAD	
PS4	PS4N	4P	2-11	2, 3, 4 . . . 11	4 COM, 44 LOAD	
PS5	PS5N	5P	2-11	2, 3, 4 . . . 11	5 COM, 55 LOAD	

On each deck of multipole devices common & load terminals are in the same positions as shown in this schematic. Switch is viewed from the shaft end and shown in position 1. Terminal numbers are on switch bottom. Stopper positions are molded on the top of the switch.

- Standard Hardware shown on last page of this section.

Panel Cutout



Maximum Effective Panel Thickness Without Locking Ring  
.189" (4.8mm)

Top

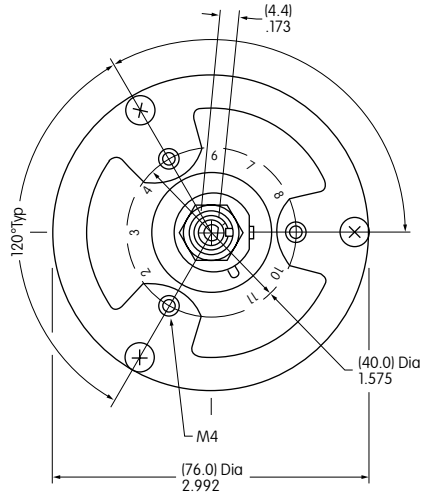

Bottom



PS4N

## SHAFT TYPES

### D Flat Shaft

For use with AT431 and AT432

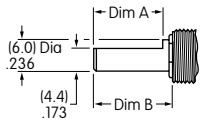

Dimension A	Dimension B
For TS (13.0) .512	For TS (15.6) .614
For HS (10.0) or PS .394	For HS (15.0) or PS .591

### Knurled Shaft

Not for use with AT431 or AT432



## OPTIONAL KNOBS FOR D FLAT SHAFTS

### AT431 Large Knob

Phenolic Resin

Black only with white indicator line

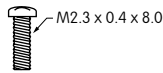
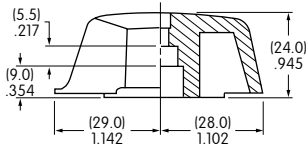
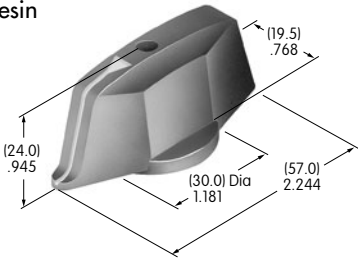

### AT432 Small Knob

Phenolic Resin

Black only with white indicator line

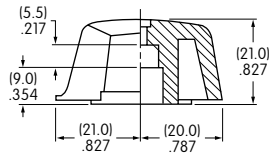
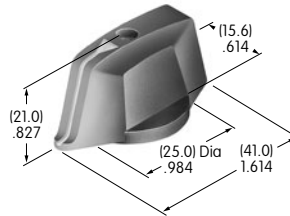

### Knob Orientation

The rotary knobs used on the D-flat shafts can be oriented on the switch to suit the customer's particular front panel needs simply by sliding the knob over the square adaptor at the preferred orientation.



## STOPPER SETTING

### For HS16, TS, & PS Models

The HS16, TS, and PS switches are supplied with the stopper plate set for the maximum number of positions allowed for that model. Prior to installation, the desired stopper setting should be made:

1. Be sure the shaft is turned counterclockwise to the extreme left. If the shaft is not turned counterclockwise to the extreme left, proper setting cannot be achieved.
2. Loosen the nut far enough to allow raising the stopper plate for resetting.
3. Insert the stopper in the numbered hole for the desired stopper setting. Satisfactory switch functioning cannot be assured if the stopper plate is not properly positioned.
4. Tighten the nut firmly against the stopped plate.

### Standard Hardware Supplied with HS, TS, and PS:

- AT526 Hex Mounting Nut (quantity 3)
- AT518 Locking Ring (quantity 1)
- AT520 Split Lockwasher (quantity 1)
- Use of mounting supports on PS is optional; screws are not provided.





Компания «ЭлектроПласт» предлагает заключение долгосрочных отношений при поставках импортных электронных компонентов на взаимовыгодных условиях!

Наши преимущества:

- Оперативные поставки широкого спектра электронных компонентов отечественного и импортного производства напрямую от производителей и с крупнейших мировых складов;
- Поставка более 17-ти миллионов наименований электронных компонентов;
- Поставка сложных, дефицитных, либо снятых с производства позиций;
- Оперативные сроки поставки под заказ (от 5 рабочих дней);
- Экспресс доставка в любую точку России;
- Техническая поддержка проекта, помощь в подборе аналогов, поставка прототипов;
- Система менеджмента качества сертифицирована по Международному стандарту ISO 9001;
- Лицензия ФСБ на осуществление работ с использованием сведений, составляющих государственную тайну;
- Поставка специализированных компонентов (Xilinx, Altera, Analog Devices, Intersil, Interpoint, Microsemi, Aeroflex, Peregrine, Syfer, Eurofarad, Texas Instrument, Miteq, Cobham, E2V, MA-COM, Hittite, Mini-Circuits, General Dynamics и др.);

Помимо этого, одним из направлений компании «ЭлектроПласт» является направление «Источники питания». Мы предлагаем Вам помощь Конструкторского отдела:

- Подбор оптимального решения, техническое обоснование при выборе компонента;
- Подбор аналогов;
- Консультации по применению компонента;
- Поставка образцов и прототипов;
- Техническая поддержка проекта;
- Защита от снятия компонента с производства.



#### Как с нами связаться

**Телефон:** 8 (812) 309 58 32 (многоканальный)

**Факс:** 8 (812) 320-02-42

**Электронная почта:** [org@eplast1.ru](mailto:org@eplast1.ru)

**Адрес:** 198099, г. Санкт-Петербург, ул. Калинина, дом 2, корпус 4, литера А.