

MICRO SWITCH Global Limit Switches

GLA Series

002408

Issue 4

Datasheet



DESCRIPTION

Honeywell's MICRO SWITCH GLA Limit Switch Series is designed to global EN50041 standards and well suited for worldwide applications. The modular design (heads/actuators, bodies, and contact blocks) of the limit switch allows for rapid response to meet customer applications. The rugged die-cast metal housing of the switch is ideal for indoor and outdoor applications where a degree of IP or NEMA enclosure sealing is required. Normally closed snap-action contacts and normally closed slow-action contacts are positive opening (→).

DIFFERENTIATION

- Side rotary actuator incorporates dual bearing design which prevents side loading during operation
- Removable contact block allows for ease of wiring
- Modular design of limit switch (heads/actuators, bodies, and contact blocks) allows for rapid customization and delivery
- Optional 1 LED or 2 LED pilot lights in limit switch front cover to indicate voltage present to switch and/or switch actuated
- Specialty contact options, sequential (2-step style) action, and center neutral action

PORTFOLIO

The GLA Limit Switch Series with standard or plug-in housings (EN50041 design, with 30 mm x 60 mm mounting) complement the smaller GLC Series, GLD Series and GLE Series (EN50047 design, with 20 mm to 22 mm mounting).

The GLA Series is part of the MICRO SWITCH Limit Switch Series that includes the [HDLS Series \(Heavy Duty Limit Switch\)](#) and [General Purpose Limit Switch \(LS\) Series](#).

FEATURES

- Designed to EN50041 standard, 30 mm x 60 mm mounting
- Available as a standard body or plug-in body with same footprint
- Wide range of actuator heads and levers
- Side rotary switches factory set for CW and CCW actuation; field adjustable for CW only or CCW only
- Certified for global applications; UL/CSA (Americas/Canada), CE (Europe), CCC (Asia-Pacific)¹
- Conforms to IEC/EN 60947-5-1, EN45545-2 (GLA/GLF Series)
- Sealed to IP67 and NEMA/UL 1, 4, 12, and 13
- Operating temperatures as low as -40 °C to 85 °C [-40 °F to 185 °F]
- Multiple connectivity options to meet most applications: four different threaded conduits, micro-change connectors, mini-change connectors, Deutsch style 4-pin connector
- One or two LED indicators available in switch body
- Single pole double throw, two pole single throw contact blocks (1NC/1NO, 2NC, 2NO) are galvanically (electrically) isolated (Zb) and designed with bifurcated contacts
- Two pole double throw contact block (2NC/2NO) has each pole galvanically (electrically) isolated (Zb)
- Normally closed contacts are positive opening (→), except center neutral style
- Contact blocks are available as snap action or slow action
- Analog output available with side rotary actuator
- Mechanical life up to 15 million operations

POTENTIAL APPLICATIONS

- Aerial lifts, boom lifts
- Automotive assembly lines and machining centers
- Agriculture equipment
- Conveyors
- Doors and apertures
- Material handling
- Machine tools
- Railroad locomotives and railroad signaling equipment
- Transportation hubs
- Valves

VALUE TO CUSTOMERS

- Easy to install and maintain
- Rugged metal construction

¹CCC certification is not available on the GL Series Switches sold within Europe, Middle East, and Africa. Option for CCC certification in these regions is available upon request.

MICRO SWITCH Global Limit Switches, GLA Series

Table 1. Specifications

Characteristic	Parameter
Description	EN50041 industrial grade limit switch, standard body or plug-in body with 30 mm x 60 mm mounting
Certifications	CE, CCC ¹ , CSA, UL
Conforming to standards	IEC/EN 60947-5-1, EN45545-2 (GLA/GLF Series)
Housing material	Electrostatic epoxy coated zinc
Actuators	Side rotary, top pin plunger, top adjustable plunger, top roller plunger, top roller lever, wobble stick (multi-directional) actuator, cat whisker (multi-directional) actuator
Termination	0.5-14 NPT; PG 13,5; M20; G 1/2 (PF 1/2); Deutsch style 4-pin connector; Micro-change connector; Mini-change connector; Pre-cabled
Contact options*	1NC/1NO, 2NC, 2NO, 2NC/2NO, 2NC/2NO sequential, 2NC/2NO center neutral
Contact type	Snap action, slow action break-before-make (BBM), slow action make-before-break (MBB), slow action
Contact material	Silver alloy (standard), gold-plated (low-energy applications)
Utilization category	ac15, A300/A600; dc13, Q300
Rated operational voltage (Ue)	240 Vac, 600 Vac, 250 Vdc
Rated operational current (Ie)	3 A, 1.2 A, 0.27 A
Thermal current (Ith)	10 A, 2.5 A
Rated insulation voltage (Ui)	300 V; 600 V
Rated impulse withstand voltage (Uimp)	2500 V
Short circuit protective device (SCPD), type, and rating	Class J fuse, rated 10A, 600 V
Pollution degree	3
Sealing	IP67; NEMA/UL 1, 4, 12, and 13
Operating temperature	-40 °C to 85 °C [-40 °C to 185 °F] side rotary actuator -25 °C to 85 °C [-13 °F to 185 °F] other actuators
Mechanical life	Up to 15 million operations
Vibration (actuator not fitted)	10 g conforming to IEC 68-2-6
Shock (actuator not fitted)	50 g conforming to IEC 68-2-27
Options	Standard limit switch with 1 LED pilot light (GLF Series) or 2 LED pilot lights (GLH Series) in front cover Plug-in limit switch with 1 LED pilot light (GLG Series) in front cover

*Normally closed (NC) contacts are positive opening except for the center neutral limit switches

¹CCC certification is not available on the GL Series Switches sold within Europe, Middle East, and Africa. Option for CCC certification in these regions is available upon request.

Table 2. Electrical Ratings

Electrical Rating				
ac		dc		Gold-plated contacts
A600 Ue (Volts)	AC15 Ie (Amps)	Q300 Ue (Volts)	DC13 Ie (Amps)	
120	6	24	2.8	1 V 10 μA min. 50 V 100 mA max.
240	3	125	0.55	
380	1.9	250	0.27	
480	1.5			
500	1.4			
600	1.2			

MICRO SWITCH Global Limit Switches, GLA Series

Figure 1. Product Nomenclature


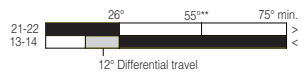

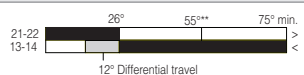
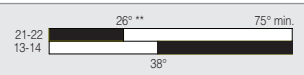
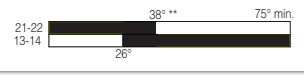
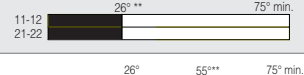


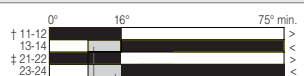

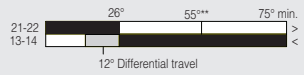
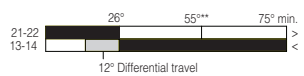
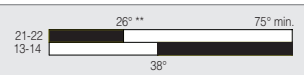
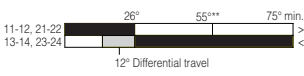
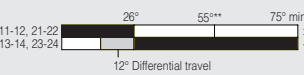
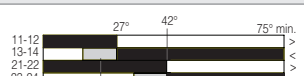
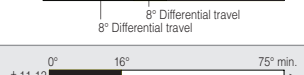
GL	A	A	01	A	E7B				
Switch Type	Body Style (EN50041)	Conduit	Basic Switch		Heads	Actuators or Levers*			
GL Series Global Limit Switch	A Non plug-in	A 0.5-14 NPT	01 1NC/1NO, SPDT snap action	20 2NC/2NO, DPDT snap action	A Side rotary	1A 38 mm fixed, 19 x 6 nylon roller	3 38 mm fixed yoke, no rollers	7A 150 mm x Ø6.4 mm plastic rod	1 CW actuation only
	B Plug-in	B PG 13,5	07 1NC/1NO, SPDT, gold contacts, snap action	22 2NC/2NO, DPDT, gold contacts, snap action	J Side rotary, center neutral	1B 38 mm fixed, 19 x 6 steel roller	3A 38 mm fixed yoke, 19 x 6 nylon rollers	7B 141 mm x Ø6.7 mm coil spring	2 CCW actuation only
	F Non plug-in with 1 LED pilot light	C 20 mm	02 1NC/1NO, SPDT snap action**	24 2NC/2NO, DPDT snap action, LED	B Top pin plunger (SST)	1C 38 mm fixed, 25 x 12 nylon roller	3B 38 mm fixed yoke, 19 x 6 steel rollers	7C 153 mm x Ø4.7 mm steel coil spring	3 Head with lever to right
	G Plug-in with 1 LED pilot light	D G 1/2 (PF 1/2)	12 1NC/1NO, SPDT snap action, 1 LED**	32 2NC/2NO, DPDT, snap action, gold contacts, LED	C Top roller plunger, SST 12 x 5 mm roller	1T 38 mm fixed, 19 x 9 SST roller	4J Adjustable aluminum rod, 200 mm max.	7D 165 mm x Ø1.3 mm SST wire	4 Head with lever to left
	H Non plug-in with 2 LED pilot lights		03 1NC/1NO, SPDT, BBM, slow action	21 2NC/2NO, DPDT, snap action, sequential	D Top roller lever, nylon 19 x 8 mm roller	1Y 38 mm fixed, 50 x 10 rubber roller	4K Adjustable aluminum rod, 140 mm max.	8A 140 mm x Ø1.2 mm SST wire	5 Head with lever to mounting surface
			33 1NC/1NO, SPDT, BBM, slow action, gold contacts	28 2NC/2NO, DPDT, snap action, gold contacts, sequential	H Top adjustable plunger	2A 38 to 93 mm adjustable, 19 x 6 nylon roller	4N Adjustable SST rod, 318 mm max.	8B 190 mm x Ø1.2 mm SST wire	6 Roller plunger perpendicular to mtg. surface
			04 1NC/1NO, SPDT, MBB, slow action	25 2NC/2NO, DPDT, snap action, LED, sequential	E Wobble stick	2B 38 to 93 mm adjustable, 19 x 6 steel roller	5A 38 mm fixed offset, 19 x 6 nylon roller	8C 141 mm x Ø6.7 mm SST coil spring	
			34 1NC/1NO, SPDT, MBB, slow action, gold contacts	31 2NC/2NO, DPDT, snap action, gold contacts, LED, sequential	K Cat whisker	2D 38 to 93 mm adjustable, 38 x 5 nylon roller	5B 38 mm fixed offset, 19 x 6 steel roller		
			05 2NO, slow action	26 2NC/2NO, DPDT, snap action, center neutral		2W 38 to 93 mm adjustable, 38 x 12 rubber roller			
			35 2NO, slow action, gold contacts	29 2NC/2NO, DPDT, snap action, center neutral		2Y 38 to 93 mm adjustable, 50 x 10 rubber roller			
			06 2NC, slow action	27 2NC/2NO, DPDT, snap action, LED, center neutral					
			36 2NC, slow action, gold contacts	30 2NC/2NO, DPDT, snap action, LED, center neutral, gold contacts					

NOTE: Basic switch codes **02 and **12** may only be used with body styles **B** and **G**.

* Levers beginning with codes 1 to 5 are for **A** and **J** style side rotary heads only. Actuators beginning with Code 7 are for **E** style wobble stick head only. Actuators beginning with Code 8 are for **K** style cat whisker head only.

MICRO SWITCH Global Limit Switches, GLA Series

Table 3. MICRO SWITCH GLA Series Side Rotary Order Guide

							Catalog Listing*		
Head and Lever Type	Contact Arrangement	Contact Type	Contact Material	Operating Torque max. Nm [in-lb]	Bar Chart (degrees) ■ contact closed □ contact open	With LED Pilot Light/s	0.5-14 NPT Conduit	20 mm Conduit	
	Side rotary, no lever	1NC/1NO	Snap action	Silver alloy	0,33 [2.9]		-	GLAA01A	GLAC01A
		1NC/1NO	Snap action	Silver alloy	0,33 [2.9]		1 LED (yellow)	GLFA01A	-
		1NC/1NO	Snap action	Gold-plated	0,33 [2.9]		-	GLAA07A	GLAC07A
		1NC/1NO	Slow action, BBM	Silver alloy	0,33 [2.9]		-	-	GLAC03A
		1NC/1NO	Slow action, MBB	Silver alloy	0,33 [2.9]		-	GLAA04A	-
		2NC	Slow action	Silver alloy	0,33 [2.9]		-	-	GLAC06A
		2NC/2NO	Snap action	Silver alloy	0,33 [2.9]		-	GLAA20A	-
		2NC/2NO Center neutral	Snap action	Silver alloy	0,33 [2.9]		-	GLAA26J	-
		2NC/2NO Center neutral	Snap action	Gold-plated	0,33 [2.9]		-	GLAA29J	-
	Side rotary, fixed lever, nylon roller	1NC/1NO	Snap action	Silver alloy	0,33 [2.9]		-	GLAA01A1A	GLAC01A1A
		1NC/1NO	Snap action	Gold-plated	0,33 [2.9]		2 LEDs (green & yellow)	GLHA07A1A	-
		1NC/1NO	Slow action, BBM	Silver alloy	0,33 [2.9]		-	GLAA03A1A	-
		2NC/2NO	Snap action	Silver alloy	0,33 [2.9]		-	GLAA20A1A	GLAC20A1A
		2NC/2NO	Snap action	Silver alloy	0,33 [2.9]		2 LEDs (green & yellow)	-	GLHC24A1A
		2NC/2NO Sequential	Snap action	Silver alloy	0,33 [2.9]		-	GLAA21A1A	-
		2NC/2NO Center neutral	Snap action	Silver alloy	0,33 [2.9]		-	GLAA26J1A	-


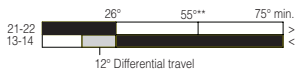
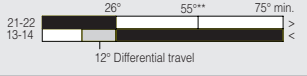
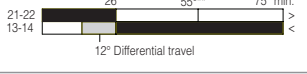
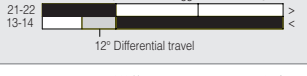
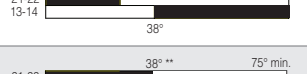
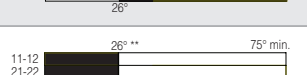
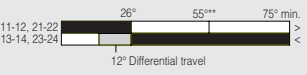
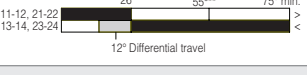
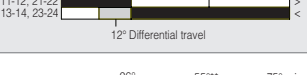
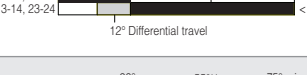
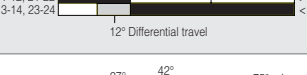
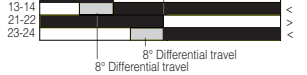

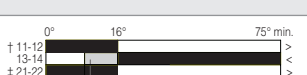
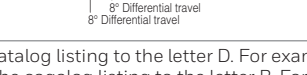
* Note: When conduit style G1/2 (PF1/2) is required, change the 4th digit in the catalog listing to the letter D. For example, GLAA01A1A would change to GLAD01A1A for G1/2 conduit. When conduit style PG13,5 is required, change the 4th digit in the catalog listing to the letter B. For example, GLAA01A1A would change to GLAB01A1A for PG13,5 conduit.

** Positive opening occurs.

† Contacts 11-12, 13-14 operate in CCW direction. ‡ Contacts 21-22, 23-24 operate in CW direction.

MICRO SWITCH Global Limit Switches, GLA Series

Table 3. MICRO SWITCH GLA Series Side Rotary Order Guide, continued

						Catalog Listing*			
Head and Lever Type	Contact Arrangement	Contact Type	Contact Material	Operating Torque max. Nm [in-lb]	Bar Chart (degrees) ■ contact closed □ contact open	With LED Pilot Light/s	0.5-14 NPT Conduit	20 mm Conduit	
 <p>Side rotary, fixed lever, steel roller</p>	1NC/1NO	Snap action	Silver alloy	0,33 [2.9]		-	GLAA01A1B	GLAC01A1B	
	1NC/1NO	Snap action	Silver alloy	0,33 [2.9]		1 LED (yellow)	GLFA01A1B	-	
	1NC/1NO	Snap action	Silver alloy	0,33 [2.9]		2 LEDs (green & yellow)	GLHA01A1B	GLHC01A1B	
	1NC/1NO	Snap action	Gold-plated	0,33 [2.9]		-	GLAA07A1B	GLAC07A1B	
	1NC/1NO	Slow action, BBM	Silver alloy	0,33 [2.9]		-	GLAA03A1B	-	
	1NC/1NO	Slow action, MBB	Silver alloy	0,33 [2.9]		-	GLAA04A1B	-	
	2NC	Slow action	Silver alloy	0,33 [2.9]		-	GLAA06A1B	GLAC06A1B	
	2NC/2NO	Snap action	Silver alloy	0,33 [2.9]		-	GLAA20A1B	GLAC20A1B	
	2NC/2NO	Snap action	Gold-plated	0,33 [2.9]		-	GLAA22A1B	-	
	2NC/2NO	Snap action	Silver alloy	0,33 [2.9]		1 LED (yellow)	GLFA24A1B	-	
	2NC/2NO	Snap action	Silver alloy	0,33 [2.9]		2 LEDs (green & yellow)	-	-	
	2NC/2NO	Snap action	Gold-plated	0,33 [2.9]		2 LEDs (green & yellow)	GLHA32A1B	-	
	2NC/2NO Sequential	Snap action	Silver alloy	0,33 [2.9]		-	-	GLAC21A1B	
	2NC/2NO Center neutral	Snap action	Silver alloy	0,33 [2.9]		-	GLAA26J1B	-	
	2NC/2NO Center neutral	Snap action	Gold-plated	0,33 [2.9]		-	GLAA29J1B	-	



















* Note: When conduit style G1/2 (PF1/2) is required, change the 4th digit in the catalog listing to the letter D. For example, GLAA01A1A would change to GLAD01A1A for G1/2 conduit. When conduit style PG13,5 is required, change the 4th digit in the catalog listing to the letter B. For example, GLAA01A1A would change to GLAB01A1A for PG13,5 conduit.

** Positive opening occurs.

† Contacts 11-12, 13-14 operate in CCW direction. ‡ Contacts 21-22, 23-24 operate in CW direction.

MICRO SWITCH Global Limit Switches, GLA Series

Table 3. MICRO SWITCH GLA Series Side Rotary Order Guide, continued


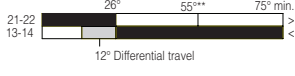

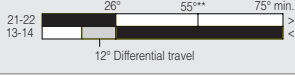

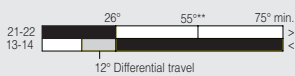
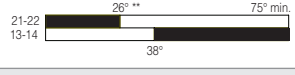
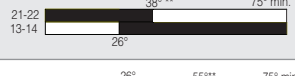


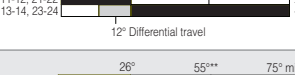
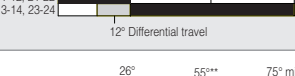
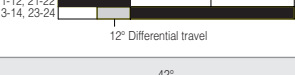
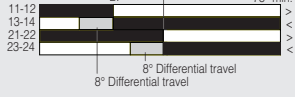
							Catalog Listing*		
Head and Lever Type	Contact Arrangement	Contact Type	Contact Material	Operating Torque max. Nm [in-lb]	Bar Chart (degrees)	With LED Pilot Light/s	0.5-14 NPT Conduit	20 mm Conduit	
 <p>Side rotary, adjustable lever, nylon roller</p>	1NC/1NO	Snap action	Silver alloy	0,33 [2.9]		-	GLAA01A2A	GLAC01A2A	
	1NC/1NO	Snap action	Gold-plated	0,33 [2.9]		-	GLAA07A2A	-	
	2NC	Slow action	Silver alloy	0,33 [2.9]		-	GLAA06A2A	-	
	2NC/2NO	Snap action	Silver alloy	0,33 [2.9]		-	GLAA20A2A	-	
	2NC/2NO	Snap action	Gold-plated	0,33 [2.9]		-	GLAA22A2A	-	
	2NC/2NO	Snap action	Silver alloy	0,33 [2.9]		1 LED (yellow)	GLFA24A2A	-	
	2NC/2NO Center neutral	Snap action	Silver alloy	0,33 [2.9]		-	GLAA26J2A	-	
 <p>Side rotary, adjustable lever, steel roller</p>	1NC/1NO	Snap action	Silver alloy	0,33 [2.9]		-	GLAA01A2B	GLAC01A2B	
	1NC/1NO	Snap action	Gold-plated	0,33 [2.9]		-	GLAA07A2B	GLAC07A2B	
	1NC/1NO	Snap action	Silver alloy	0,33 [2.9]		1 LED (yellow)	GLFA01A2B	GLFC01A2B	
	1NC/1NO	Slow action, BBM	Silver alloy	0,33 [2.9]		-	GLAA03A2B	-	
	1NC/1NO	Slow action, BBM	Silver alloy	0,33 [2.9]		1 LED (yellow)	GLFA03A2B	-	
	1NC/1NO	Slow action, BBM	Gold-plated	0,33 [2.9]		1 LED (yellow)	GLFA33A2B	-	
	2NC	Slow action	Silver alloy	0,33 [2.9]		-	-	GLAC06A2B	
	2NC/2NO	Snap action	Silver alloy	0,33 [2.9]		-	GLAA20A2B	GLAC20A2B	
	2NC/2NO Center neutral	Snap action	Silver alloy	0,33 [2.9]		-	GLAA26J2B	-	

* Note: When conduit style G1/2 (PF1/2) is required, change the 4th digit in the catalog listing to the letter D. For example, GLAA01A1A would change to GLAD01A1A for G1/2 conduit. When conduit style PG13,5 is required, change the 4th digit in the catalog listing to the letter B. For example, GLAA01A1A would change to GLAB01A1A for PG13,5 conduit.

** Positive opening occurs. † Contacts 11-12, 13-14 operate in CCW direction. ‡ Contacts 21-22, 23-24 operate in CW direction.

MICRO SWITCH Global Limit Switches, GLA Series

Table 3. MICRO SWITCH GLA Series Side Rotary Order Guide, continued


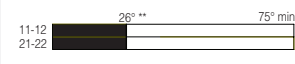
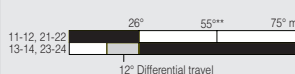
							Catalog Listing*		
Head and Lever Type	Contact Arrangement	Contact Type	Contact Material	Operating Torque max. Nm [in-lb]	Bar Chart (degrees) ■ contact closed □ contact open	With LED Pilot Light/s	0.5-14 NPT Conduit	20 mm Conduit	
 <p>Side rotary, adjustable lever, Ø 50 mm rubber roller</p>	1NC/1NO	Snap action	Silver alloy	0,33 [2.9]		-	GLAA01A2Y	-	
	 <p>Side rotary, adjustable aluminum rod</p>	1NC/1NO	Snap action	Silver alloy	0,33 [2.9]		-	GLAA01A4J	GLAC01A4J
		1NC/1NO	Snap action	Silver alloy	0,33 [2.9]		1 LED (yellow)	-	GLFC01A4J
		1NC/1NO	Snap action	Silver alloy	0,33 [2.9]		2 LEDs (green & yellow)	GLHA01A4J	-
		1NC/1NO	Slow action, BBM	Silver alloy	0,33 [2.9]		-	GLAA03A4J	-
		1NC/1NO	Slow action, MBB	Silver alloy	0,33 [2.9]		-	GLAA04A4J	-
		2NC/2NO	Snap action	Silver alloy	0,33 [2.9]		-	GLAA20A4J	-
		2NC/2NO	Snap action	Gold-plated	0,33 [2.9]		-	GLAA22A4J	-
		2NC/2NO	Snap action	Silver alloy	0,33 [2.9]		1 LED (yellow)	GLFA24A4J	-
		2NC/2NO	Snap action	Gold-plated	0,33 [2.9]		1 LED (yellow)	-	GLFC32A4J
		2NC/2NO	Snap action	Silver alloy	0,33 [2.9]		2 LEDs (green & yellow)	GLHA24A4J	-
2NC/2NO Sequential		Snap action	Silver alloy	0,33 [2.9]		-	GLAA21A4J	-	

* Note: When conduit style G1/2 (PF1/2) is required, change the 4th digit in the catalog listing to the letter D. For example, GLAA01A1A would change to GLAD01A1A for G1/2 conduit. When conduit style PG13,5 is required, change the 4th digit in the catalog listing to the letter B. For example, GLAA01A1A would change to GLAB01A1A for PG13,5 conduit.

** Positive opening occurs.

MICRO SWITCH Global Limit Switches, GLA Series


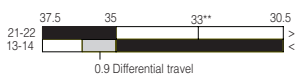


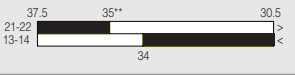
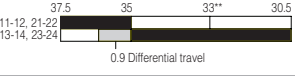
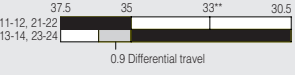
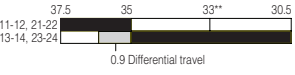
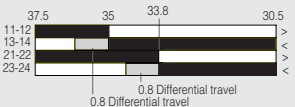
Table 3. MICRO SWITCH GLA Series Side Rotary Order Guide, continued

							Catalog Listing*		
Head and Lever Type	Contact Arrangement	Contact Type	Contact Material	Operating Torque max. Nm [in-lb]	Bar Chart (degrees)	With LED Pilot Light/s	0.5-14 NPT Conduit	20 mm Conduit	
 Side rotary, fixed offset lever, nylon roller	2NC	Slow action	Silver alloy	0,33 [2.9]		-	GLAA06A5A	-	
	2NC/2NO	Snap action	Silver alloy	0,33 [2.9]		-	GLAA20A5A	-	

* Note: When conduit style G1/2 (PF1/2) is required, change the 4th digit in the catalog listing to the letter D. For example, GLAA01A1A would change to GLAD01A1A for G1/2 conduit. When conduit style PG13,5 is required, change the 4th digit in the catalog listing to the letter B. For example, GLAA01A1A would change to GLAB01A1A for PG13,5 conduit.

** Positive opening occurs.

Table 4. MICRO SWITCH GLA Series Plunger Order Guide


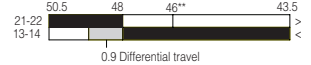
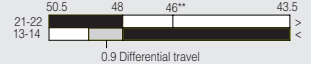
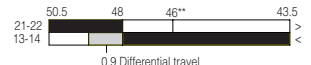
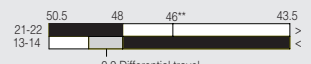
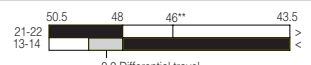
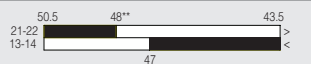

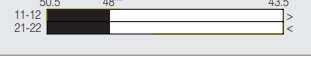
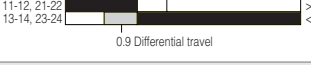
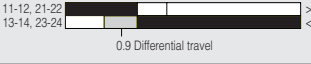

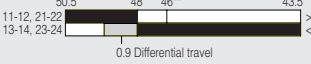
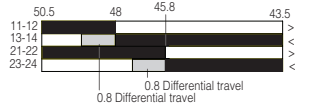
							Catalog Listing*		
Head Type	Contact Arrangement	Contact Type	Contact Material	Operating Force max. N [lb]	Bar Chart (millimeters)	With LED Pilot Light/s	0.5-14 NPT Conduit	20 mm Conduit	
 Top pin plunger	1NC/1NO	Snap action	Silver alloy	16 [3.6]		-	GLAA01B	GLAC01B	
	1NC/1NO	Snap action	Silver alloy	16 [3.6]		1 LED (yellow)	GLFA01B	GLFC01B	
	1NC/1NO	Snap action	Gold-plated	16 [3.6]		-	-	GLAC07B	
	1NC/1NO	Slow action, BBM	Silver alloy	16 [3.6]		-	GLAA03B	-	
	2NC/2NO	Snap action	Silver alloy	16 [3.6]		-	GLAA20B	GLAC20B	
	2NC/2NO	Snap action	Silver alloy	16 [3.6]		1 LED (yellow)	GLFA24B	-	
	2NC/2NO	Snap action	Gold-plated	16 [3.6]		-	GLAA22B	GLAC22B	
	2NC/2NO	Snap action	Gold-plated	16 [3.6]		1 LED (yellow)	GLFA32B	-	

* Note: When conduit style G1/2 (PF1/2) is required, change the 4th digit in the catalog listing to the letter D. For example, GLAA01A1A would change to GLAD01A1A for G1/2 conduit. When conduit style PG13,5 is required, change the 4th digit in the catalog listing to the letter B. For example, GLAA01A1A would change to GLAB01A1A for PG13,5 conduit.

** Positive opening occurs.

MICRO SWITCH Global Limit Switches, GLA Series

Table 5. MICRO SWITCH GLA Series Roller Plunger Order Guide




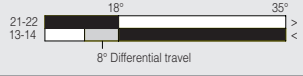



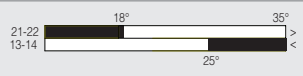
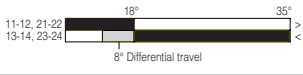
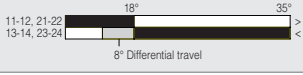

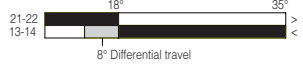
							Catalog Listing*		
Head Type	Contact Arrangement	Contact Type	Contact Material	Operating Force max. N [lb]	Bar Chart (millimeters) ■ contact closed □ contact open	With LED Pilot Light/s	0.5-14 NPT Conduit	20 mm Conduit	
 Top roller plunger	1NC/1NO	Snap action	Silver alloy	16 [3.6]		-	GLAA01C	GLAC01C	
	1NC/1NO	Snap action	Silver alloy	16 [3.6]		1 LED (yellow)	GLFA01C	-	
	1NC/1NO	Snap action	Silver alloy	16 [3.6]		2 LEDs (green & yellow)	GLHA01C	-	
	1NC/1NO	Snap action	Gold-plated	16 [3.6]		-	GLAA07C	GLAC07C	
	1NC/1NO	Snap action	Gold-plated	16 [3.6]		1 LED (yellow)	GLFA07C	-	
	1NC/1NO	Slow action, BBM	Silver alloy	16 [3.6]		-	GLAA03B	-	
	1NC/1NO	Slow action, MBB	Silver alloy	16 [3.6]		-	GLAA04B	-	
	2NC	Slow action	Silver alloy	16 [3.6]		-	GLAA06C	GLAC06C	
	2NC/2NO	Snap action	Silver alloy	16 [3.6]		-	GLAA20C	GLAC20C	
	2NC/2NO	Snap action	Gold-plated	16 [3.6]		-	GLAA22C	-	
	2NC/2NO	Snap action	Silver alloy	16 [3.6]		1 LED (yellow)	GLFA24C	-	
	2NC/2NO	Snap action	Gold-plated	16 [3.6]		2 LEDs (green & yellow)	-	GLHC32C	
2NC/2NO Sequential	Snap action	Silver alloy	16 [3.6]		-	GLAA21C	-		

* Note: When conduit style G1/2 (PF1/2) is required, change the 4th digit in the catalog listing to the letter D. For example, GLAA01A1A would change to GLAD01A1A for G1/2 conduit. When conduit style PG13,5 is required, change the 4th digit in the catalog listing to the letter B. For example, GLAA01A1A would change to GLAB01A1A for PG13,5 conduit.

** Positive opening occurs.

MICRO SWITCH Global Limit Switches, GLA Series


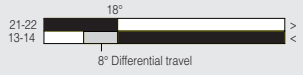

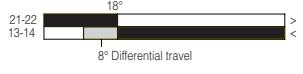


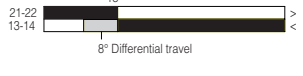
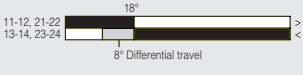
Table 6. MICRO SWITCH GLA Series Wobble Order Guide

								Catalog Listing*	
Head Type	Contact Arrangement	Contact Type	Contact Material	Operating Force max. N [lb]	Bar Chart (degrees) ■ contact closed □ contact open	With LED Pilot Light/s	0.5-14 NPT Conduit	20 mm Conduit	
	1NC/1NO	Snap action	Silver alloy	0,2 [1.8]		-	GLAA01E7A	-	
	1NC/1NO	Snap action	Silver alloy	0,2 [1.8]		-	GLAA01E7B	GLAC01E7B	
	1NC/1NO	Snap action	Silver alloy	0,2 [1.8]		1 LED (yellow)	GLFA01E7B	GLFC01E7B	
	1NC/1NO	Snap action	Silver alloy	0,2 [1.8]		2 LEDs (green & yellow)	GLHA01E7B	-	
	1NC/1NO	Snap action	Gold-plated	0,2 [1.8]		-	-	GLAC07E7B	
	1NC/1NO	Slow action, BBM	Silver alloy	0,2 [1.8]		-	-	-	
	2NC/2NO	Snap action	Silver alloy	0,2 [1.8]		-	GLAA20E7B	GLAC20E7B	
	2NC/2NO	Snap action	Silver alloy	0,2 [1.8]		1 LED (yellow)	GLFA24E7B	-	
	1NC/1NO	Snap action	Silver alloy	0,2 [1.8]		-	GLAA01E7D	-	

* Note: When conduit style G1/2 (PF1/2) is required, change the 4th digit in the catalog listing to the letter D. For example, GLAA01A1A would change to GLAD01A1A for G1/2 conduit. When conduit style PG13,5 is required, change the 4th digit in the catalog listing to the letter B. For example, GLAA01A1A would change to GLAB01A1A for PG13,5 conduit.

MICRO SWITCH Global Limit Switches, GLA Series


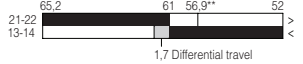
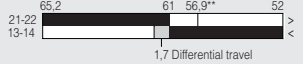
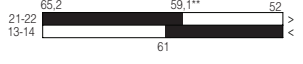
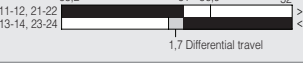
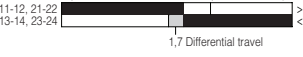
Table 6. MICRO SWITCH GLA Series Wobble Order Guide, continued

								Catalog Listing*	
Head Type	Contact Arrangement	Contact Type	Contact Material	Operating Force max. N [lb]	Bar Chart (degrees)	With LED Pilot Light/s	0.5-14 NPT Conduit	20 mm Conduit	
	1NC/1NO	Snap action	Silver alloy	0,1 [0.9]		-	GLAA01K8A	-	
	1NC/1NO	Snap action	Silver alloy	0,1 [0.9]		-	GLAA01K8B	-	
	2NC/2NO	Snap action	Silver alloy	0,1 [0.9]		-	GLAA20K8B	GLAC20K8B	
	1NC/1NO	Snap action	Silver alloy	0,1 [0.9]		-	GLAA01K8C	-	
	2NC/2NO	Snap action	Silver alloy	0,1 [0.9]		-	GLAA20K8C	-	

* Note: When conduit style G1/2 (PF1/2) is required, change the 4th digit in the catalog listing to the letter D. For example, GLAA01A1A would change to GLAD01A1A for G1/2 conduit. When conduit style PG13,5 is required, change the 4th digit in the catalog listing to the letter B. For example, GLAA01A1A would change to GLAB01A1A for PG13,5 conduit.

MICRO SWITCH Global Limit Switches, GLA Series

Table 7. MICRO SWITCH GLA Series Top Roller Lever Order Guide

								Catalog Listing*	
Head Type	Contact Arrangement	Contact Type	Contact Material	Operating Force max. N [lb]	Bar Chart (millimeters) ■ contact closed □ contact open	With LED Pilot Light/s	0.5-14 NPT Conduit	20 mm Conduit	
 Top roller lever	1NC/1NO	Snap action	Silver alloy	9,5 [2.1]		—	GLAA01D	GLAC01D	
	1NC/1NO	Snap action	Silver alloy	9,5 [2.1]		1 LED (yellow)	GLFA01D	—	
	1NC/1NO	Slow action, MBB	Silver alloy	9,5 [2.1]		—	GLAA04D	—	
	2NC/2NO	Snap action	Silver alloy	9,5 [2.1]		—	GLAA20D	GLAC20D	
	2NC/2NO	Snap action	Gold-plated	9,5 [2.1]		—	GLAA22D	GLAC22D	

* Note: When conduit style G1/2 (PF1/2) is required, change the 4th digit in the catalog listing to the letter D. For example, GLAA01A1A would change to GLAD01A1A for G1/2 conduit. When conduit style PG13,5 is required, change the 4th digit in the catalog listing to the letter B. For example, GLAA01A1A would change to GLAB01A1A for PG13,5 conduit.

** Positive opening occurs.

MICRO SWITCH Global Limit Switches, GLA Series

Table 8. MICRO SWITCH GLB Series Side Rotary Order Guide (Plug-in Body)

							Catalog Listing*		
Head Type	Contact Arrangement	Contact Type	Contact Material	Operating Torque max. Nm [in-lb]	Bar Chart (degrees) ■ contact closed □ contact open	With LED Pilot Light/s	0.5-14 NPT Conduit	20 mm Conduit	
	Side rotary, no lever	1NC/1NO	Snap action	Silver alloy	0,33 [2.9]		-	GLBA02A	GLBC02A
	Side rotary, fixed lever, nylon roller	1NC/1NO	Snap action	Silver alloy	0,33 [2.9]		-	GLBA02A1A	-
	Side rotary, fixed lever, steel roller	1NC/1NO	Snap action	Silver alloy	0,33 [2.9]		-	GLBA02A1B	GLBC02A1B
		1NC/1NO	Snap action	Silver alloy	0,33 [2.9]		1 LED (yellow)	GLGA12A1B	GLGC12A1B
	Side rotary, adjustable lever, nylon roller	1NC/1NO	Snap action	Silver alloy	0,33 [2.9]		-	GLBA02A2A	GLBC02A2A
	Side rotary, adjustable lever, steel roller	1NC/1NO	Snap action	Silver alloy	0,33 [2.9]		-	GLBA02A2B	GLBC02A2B
		1NC/1NO	Snap action	Silver alloy	0,33 [2.9]		1 LED (yellow)	GLGA12A2B	-
	Side rotary, adjustable aluminum rod	1NC/1NO	Snap action	Silver alloy	0,33 [2.9]		-	GLBA02A4J	GLBC02A4J
		1NC/1NO	Snap action	Silver alloy	0,33 [2.9]		1 LED (yellow)	GLGA12A4J	-

* Note: When conduit style G1/2 (PF1/2) is required, change the 4th digit in the catalog listing to the letter D. For example, GLA01A1A would change to GLAD01A1A for G1/2 conduit. When conduit style PG13,5 is required, change the 4th digit in the catalog listing to the letter B. For example, GLA01A1A would change to GLAB01A1A for PG13,5 conduit.

** Positive opening occurs.

MICRO SWITCH Global Limit Switches, GLA Series

Table 9. MICRO SWITCH GLB Series Top Plunger Order Guide (Plug-in Body)



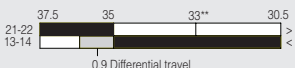

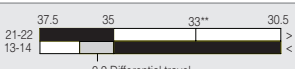

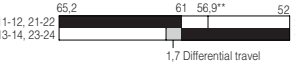
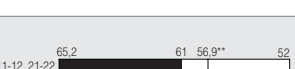
							Catalog Listing*		
Head Type	Contact Arrangement	Contact Type	Contact Mtl	Operating Force max. N [lb]	Bar Chart (millimeters) ■ contact closed □ contact open	With LED Pilot Light/s	0.5-14 NPT Conduit	20 mm Conduit	
	Top pin plunger	1NC/1NO	Snap action	Silver alloy	16 [3.6]		-	GLBA02B	GLBC02B
		1NC/1NO	Snap action	Silver alloy	16 [3.6]		1 LED (yellow)	GLGA12B	GLGC12B
	Top roller plunger	1NC/1NO	Snap action	Silver alloy	16 [3.6]		-	GLBA02C	GLBC02C
		1NC/1NO	Snap action	Silver alloy	16 [3.6]		1 LED (yellow)	GLGA12C	-

Table 10. MICRO SWITCH GLB Series Top Roller Lever Order Guide (Plug-in Body)





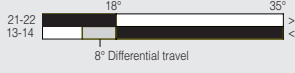

							Catalog Listing*		
Head Type	Contact Arrangement	Contact Type	Contact Mtl	Operating Force max. N [lb]	Bar Chart (millimeters) ■ contact closed □ contact open	With LED Pilot Light	0.5-14 NPT Conduit	20 mm Conduit	
	Top roller lever	1NC/1NO	Snap action	Silver alloy	9.5 [2.1]		-	GLBA02D	GLBC02D
		1NC/1NO	Snap action	Silver alloy	9.5 [2.1]		1 LED (yellow)	GLGA12D	-

* Note: When conduit style G1/2 (PF1/2) is required, change the 4th digit in the catalog listing to the letter D. For example, GLAA01A1A would change to GLAD01A1A for G1/2 conduit. When conduit style PG13,5 is required, change the 4th digit in the catalog listing to the letter B. For example, GLAA01A1A would change to GLAB01A1A for PG13,5 conduit.

** Positive opening occurs.

MICRO SWITCH Global Limit Switches, GLA Series

Table 11. MICRO SWITCH GLB Series Wobble Order Guide (Plug-in Body)

Catalog Listing*									
Head Type	Contact Arrangement	Contact Type	Contact Mtl	Operating Force max. N [lb]	Bar Chart (degrees) ■ contact closed □ contact open	With LED Pilot Light/s	0.5-14 NPT Conduit	20 mm Conduit	
	Wobble stick, 150 mm plastic rod	1NC/1NO	Snap action	Silver alloy	0,1 [0.9]		-	GLBA02E7A	-
	Wobble stick, 141 mm coil spring	1NC/1NO	Snap action	Silver alloy	0,1 [0.9]		-	GLBA02E7B	GLBC02E7B
	1NC/1NO	Snap action	Silver alloy	0,1 [0.9]		1 LED (yellow)	GLGA12E7B	-	
	Cat Whisker, 190 mm sst wire	1NC/1NO	Snap action	Silver alloy	0,1 [0.9]		-	GLBA02K8B	-
Cat whisker, 141 mm sst coil spring	1NC/1NO	Snap action	Silver alloy	0,1 [0.9]		-	GLBA02K8C	-	

* Note: When conduit style G1/2 (PF1/2) is required, change the 4th digit in the catalog listing to the letter D. For example, GLA**A**01A1A would change to GLA**D**01A1A for G1/2 conduit. When conduit style PG13,5 is required, change the 4th digit in the catalog listing to the letter B. For example, GLA**A**01A1A would change to GLA**B**01A1A for PG13,5 conduit.

MICRO SWITCH Global Limit Switches, GLA Series

Product Dimensions: GLA Series

Figure 2. Fixed Lever, Side Rotary Switch - Non-plug-in Body Style, GLZ51 Style Lever, and GLA Body

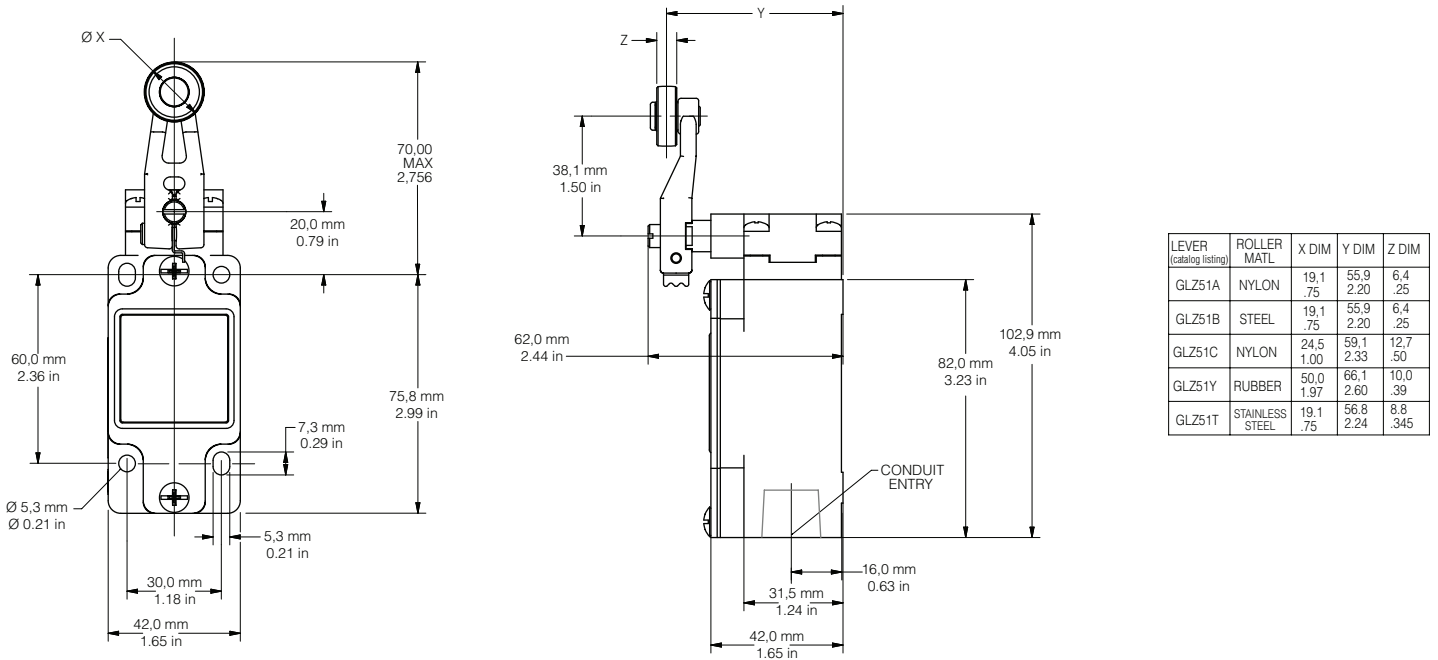
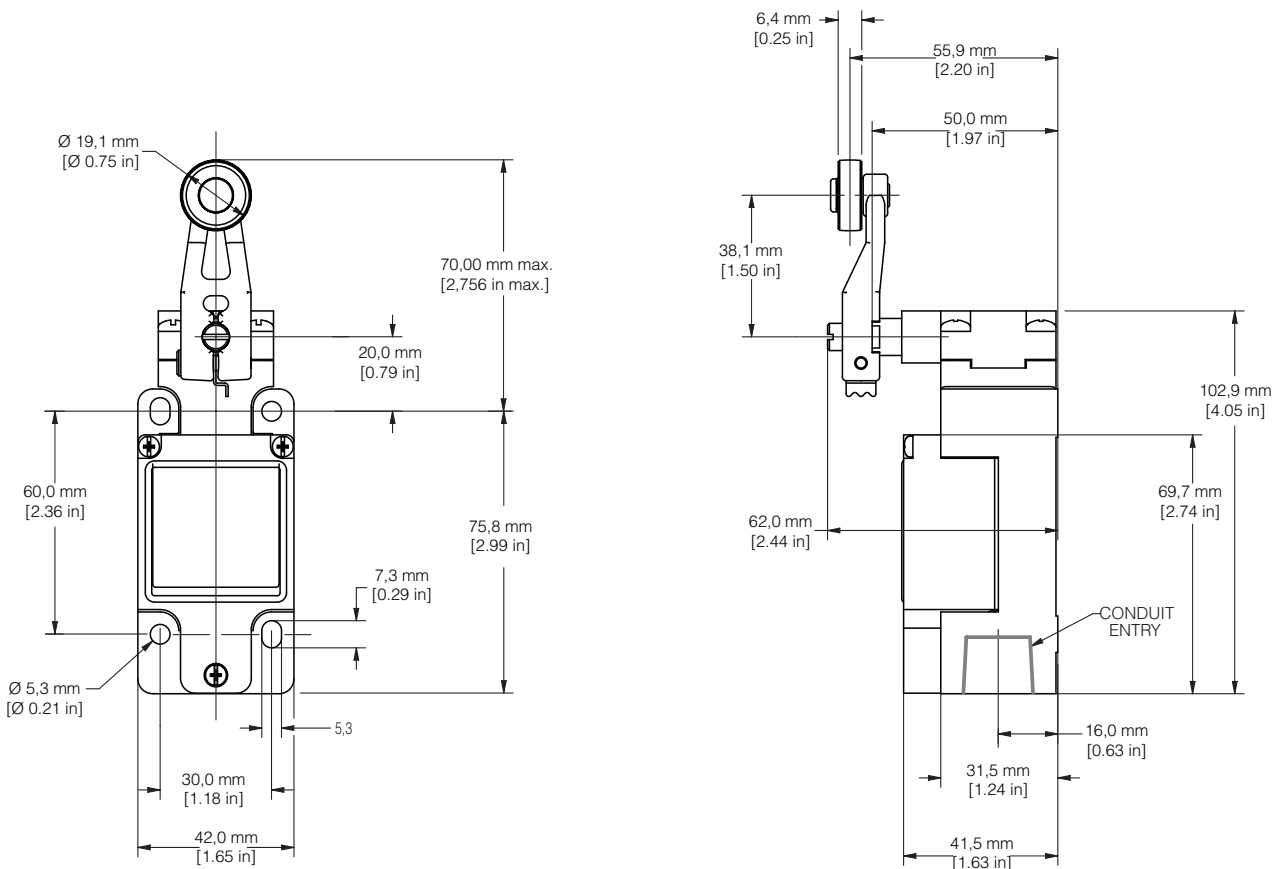
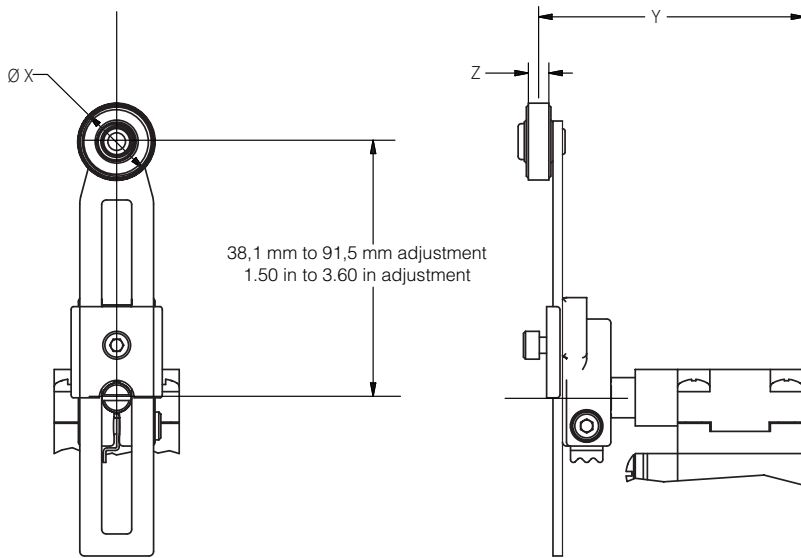


Figure 3. Fixed Lever, Side Rotary Switch - Plug-in Body Style, GLZ51 Style Lever, and GLB Body



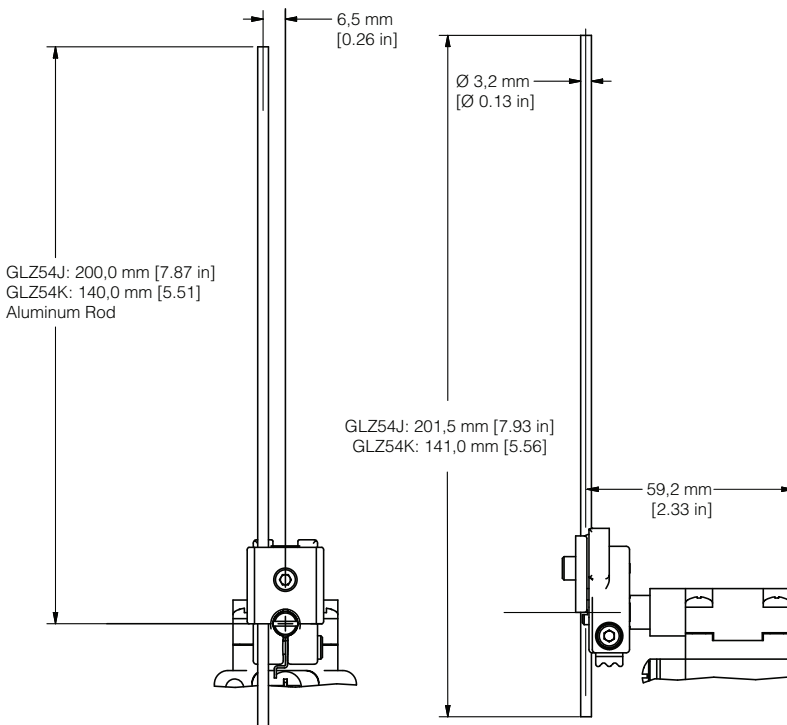
MICRO SWITCH Global Limit Switches, GLA Series

Figure 4. Adjustable Lever Dimensions, GLZ52



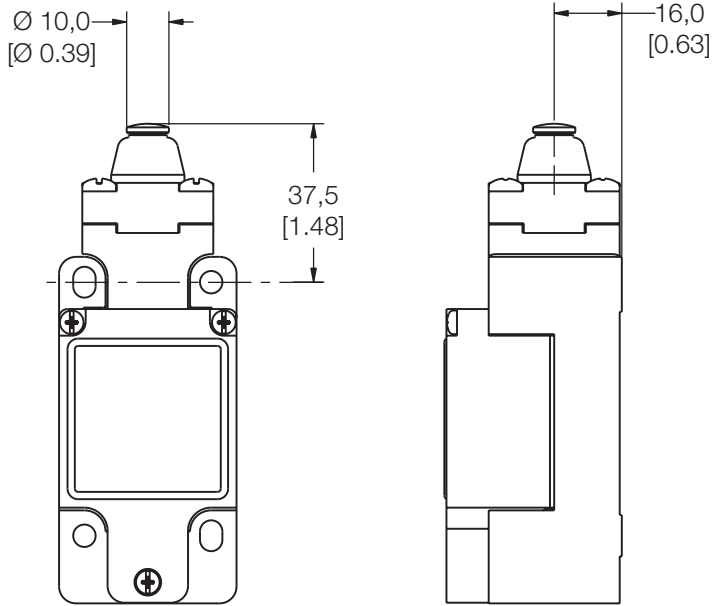
LEVER	ROLLER MATL	X DIM	Y DIM	Z DIM
GLZ52A	NYLON	19,1 .75	65,9 2.59	6,4 .25
GLZ52B	STEEL	19,1 .75	65,9 2.59	6,4 .25
GLZ52D	NYLON	38,1 1.5	65,9 2.59	6,4 .25
GLZ52E	NYLON	19,1 .75	79,37 3.125	33,07 1.300
GLZ52W	RUBBER	40,0 1.6	71,5 2.81	12,7 .5
GLZ52Y	RUBBER	50,0 1.97	68,8 2.71	10,0 .39

Figure 5. Aluminum Rod Lever Dimensions, GLZ54



MICRO SWITCH Global Limit Switches, GLA Series

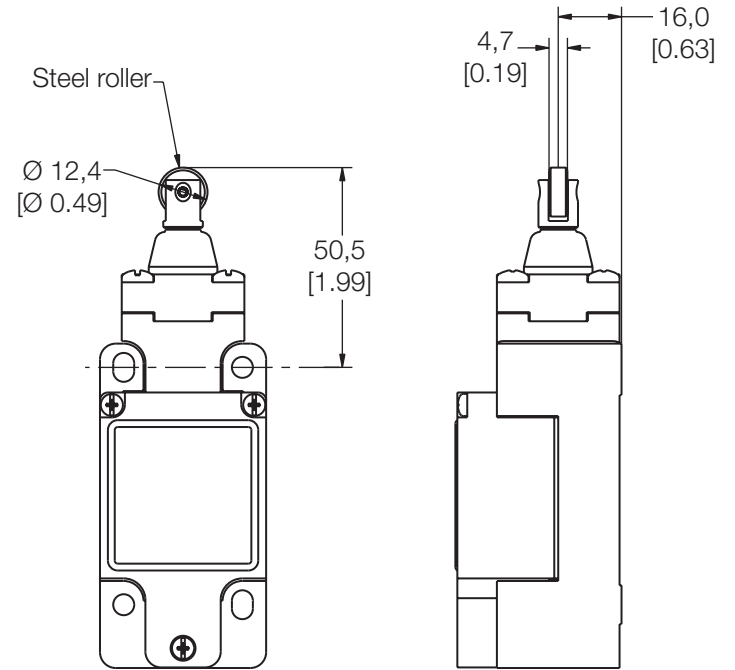
Figure 6. Pin Plunger Dimensions



Top Pin Plunger

Refer to Figure 2 or 3 for other dimensions

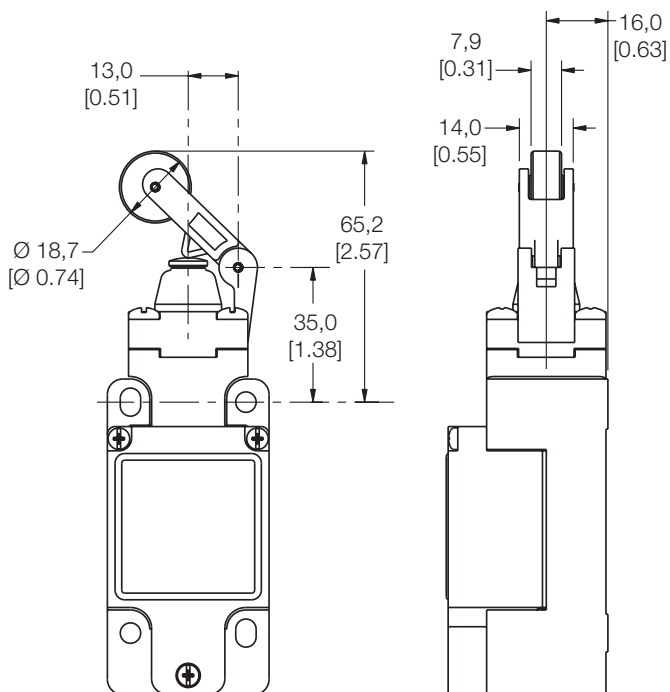
Figure 7. Roller Plunger Dimensions



Top Roller Plunger

Refer to Figure 2 or 3 for other dimensions

Figure 8. Roller Lever Dimensions



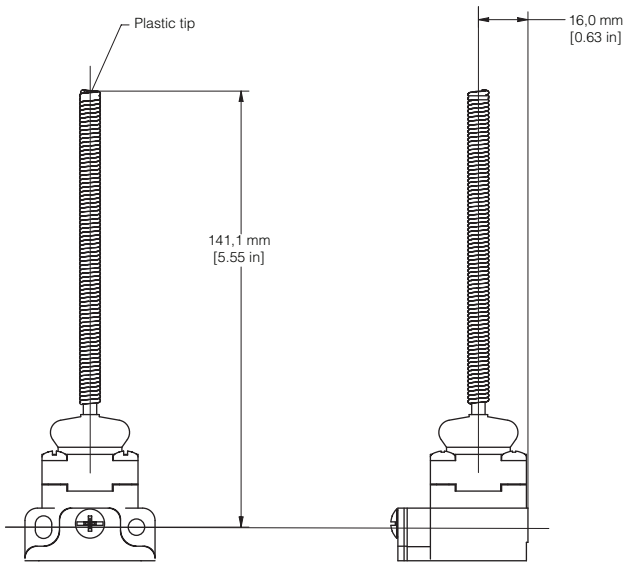
Top Roller Lever

Refer to Figure 2 or 3 for other dimensions

MICRO SWITCH Global Limit Switches, GLA Series

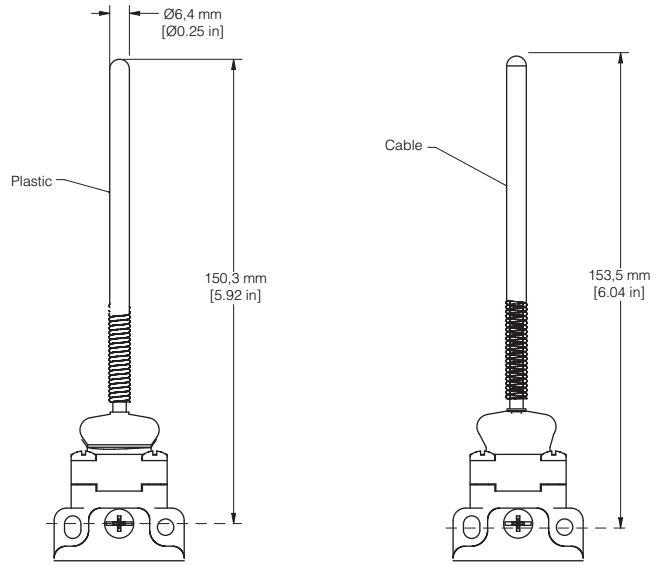
Head Code: E • WOBBLE AND CAT WHISKER ACTUATOR DIMENSIONS

Figure 9. Coil Actuator



Refer to Figure 2 or 3 for other dimensions

Figure 10. Plastic Rod and Flexible Cable



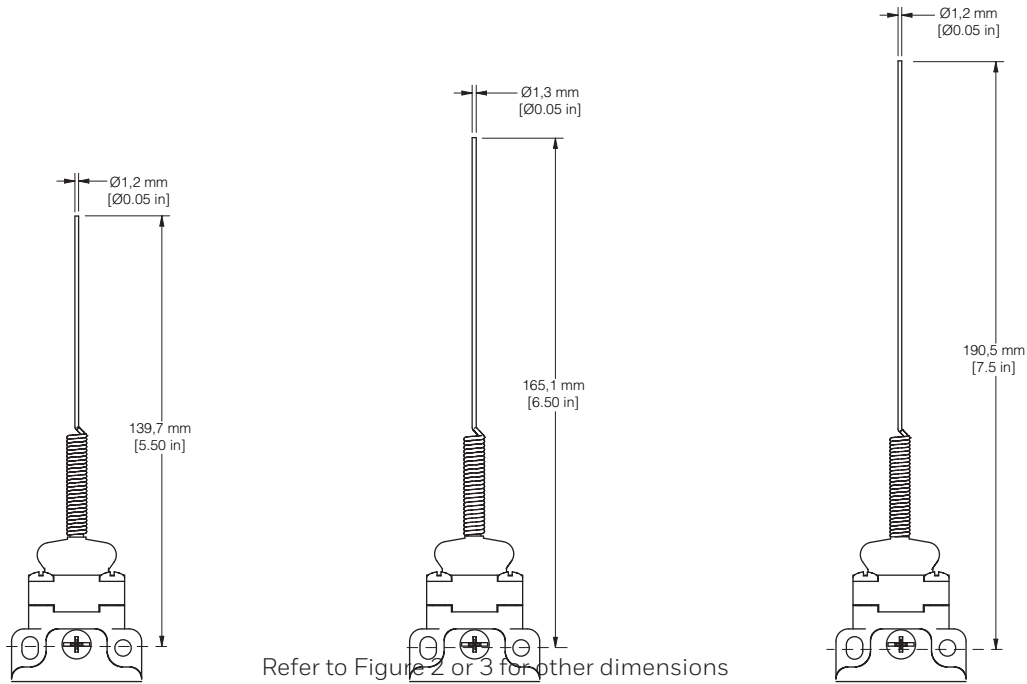
Refer to Figure 2 or 3 for other dimensions

Figure 11. Cat Whisker Wobbles

5.5 inches (stainless steel)

6.5 inches (stainless steel)

7.5 inches (stainless steel)



Refer to Figure 2 or 3 for other dimensions

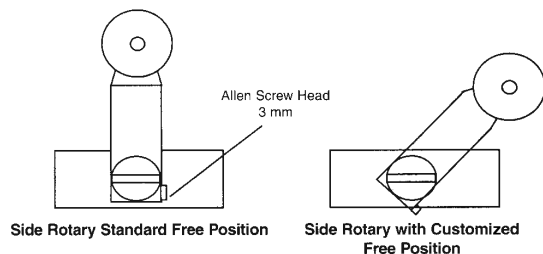
MICRO SWITCH Global Limit Switches, GLA Series

APPLICATION INFORMATION

Side Rotary Assemblies

The side rotary assemblies incorporate a feature for adjusting the free position of the side rotary lever. The EN 50041 body style allows infinite adjustment and reclamp. See the following diagrams for details of the mechanism in each case.

Figure 12. Standard EN 50041 Body Style



There are two lever mounting options:

1. By fully seating the lever in one of the four 90° detent positions on the shaft hub which provides positive lever retention.
2. By mounting the lever on the serrated portion of the shaft (which enables the lever to be mounted in any position).

To change the rotary lever's free position:

1. Use a 3 mm hex Allen wrench to loosen the Allen screw, as shown in Figure 13, below.
2. Back off the lever 2 mm and move it to the desired free position.
3. Retighten the Allen screw.
4. Check to see if the free position is satisfactory for the application.
5. Repeat the adjustment procedure if necessary.

A teller tab located at the bottom of the lever (see diagram below) helps prevent lever slippage. It enables the installer to detect the correct tightening torque. When this tab cannot be moved, the Allen screw has been tightened properly.

Figure 13. Allen Screw and Teller Tab Location

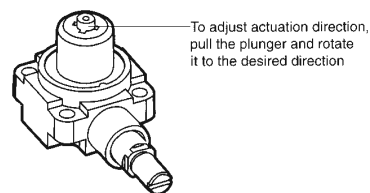


EN 50041 Side Rotary Actuator Direction Adjustment

As furnished, GLS rotary switches will operate when the lever is rotated from either the left or right. They can be field modified to operate in one direction only (Clockwise CW; Counter clockwise CCW) by following these steps:

1. Carefully remove the complete head assembly.
2. Turn the head assembly upside down as shown in Figure 14.
3. Pull the plunger mechanism out and rotate it through 90° increments until the alignment tab points to the desired function (CW, CCW, or CW and CCW).
4. Push plunger mechanism in.
5. Reassemble the head assembly and re-test the switch in its application.

Figure 14. Actuation Adjustment



REPLACEMENT INSTRUCTIONS

All levers for side rotary assemblies are available as replacement parts. All basics, except the plug-in, can be replaced. All EN 50041 heads can be replaced. The replacement procedures for these components are straightforward in nature.

Side Rotary Levers

Remove the lever from the product being replaced. On EN 50041 product this is achieved by loosening the Allen screw holding the lever on the shaft. Replace the lever and tighten the Allen screw or combination screw. Re-test the switch in its application.

Heads

All EN 50041 style switch heads can be removed and replaced.

1. Remove the head by unscrewing the four retaining screws on the head assembly.
2. Ensure replacement part is identical to one being removed.
3. Re-test the assembly and ensure correct operation.

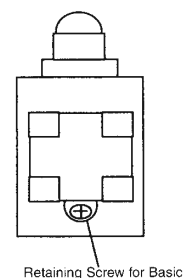
Basic Switches

Non-plug-in

Basic switches can be removed and replaced by following this procedure:

1. Remove the cover from the body.
2. Before disconnecting the switch wiring, carefully note the wiring arrangement for your application, particularly the safety ground connection.
3. Remove the basic switch retaining screw.
4. Remove the basic switch and install the replacement basic switch.
5. Use the retaining screw to install the new basic switch – ensure that it is correctly seated in the switch body.
6. Wire the switch terminals as before.
7. Before replacing the cover – ensure that the basic switch wires are not twisted or otherwise lifted from the basic switch (to prevent them from becoming trapped when the cover is replaced).
8. Test the switch in its application.

Figure 15. Retaining screw location



MICRO SWITCH Global Limit Switches, GLA Series

Basic Switches

Plug-in EN50041 body style

The switch enclosure portion of this two-piece body style plugs into a pre-wired terminal block mounted in the application. Replacement is accomplished by unplugging the old switch enclosure and plugging-in a new switch enclosure (basics are permanently staked in the switch enclosure).

LED WIRING

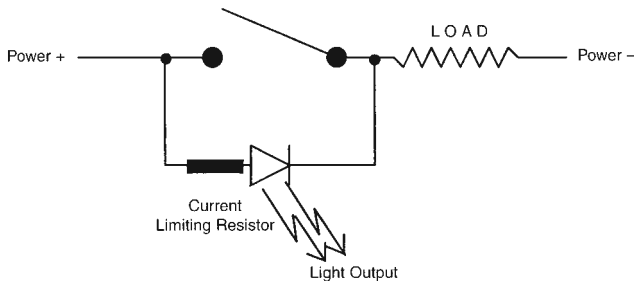
The GLF, GLG, and GLH versions of GLS (EN 50041) come complete with LED indicators. These indicators can be wired in a variety of ways. Operation can indicate switch free or switch operated depending on the wiring arrangement employed. The table below indicates the body styles and indicators offered.

Table 12. LED Series

Body	Function	Specification
GLF	1 LED	12 → 250 Vac and dc less than 1.5 mA draw
GLG	1 LED plug-in	12 → 250 Vac and dc less than 1.5 mA draw
GLH	2 LED	18 → 30 Vdc 7 mA typ. current draw

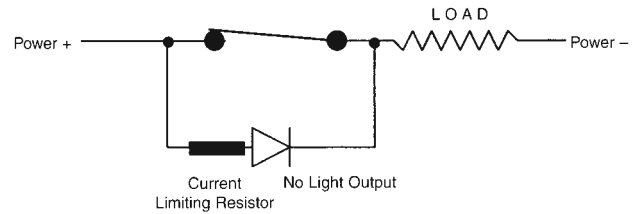
The following wiring diagrams show possible configurations that can be used for the LEDs. Combinations of these arrangements can be used where the dual LED versions of GLS are employed.

Figure 16. Wiring Diagram 1



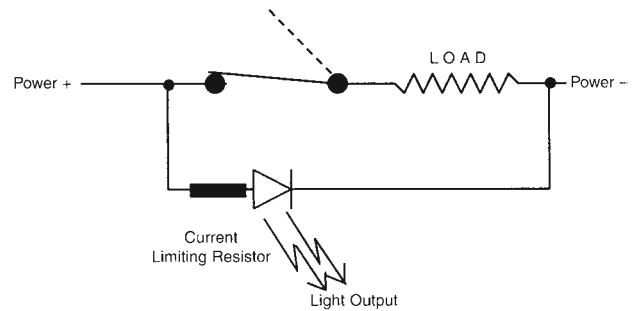
In Figure 16, Wiring Diagram 1, the basic switch contact is open. The current for the LED can flow through the LED (via the load) and the LED illuminates.

Figure 17. Wiring Diagram 2



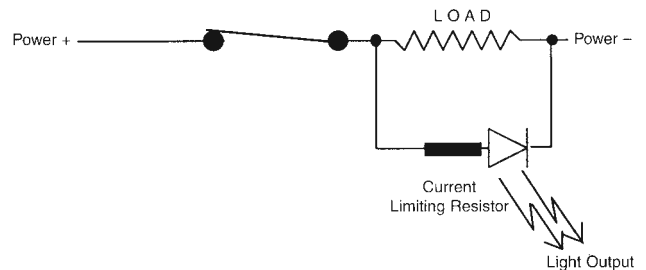
In Figure 17, Wiring Diagram 2, the basic switch contact is closed. The current for the LED cannot flow through the LED and the LED will not illuminate.

Figure 18. Wiring Diagram 3



In Figure 18, Wiring Diagram 3, regardless of the position of the basic switch, the current for the LED can flow through the LED and the LED will illuminate indicating power available.

Figure 19. Wiring Diagram 4









In Figure 19, Wiring Diagram 4, when the load is energized the LED will illuminate. The above examples suggest options with these versions of GLS. The LED pilot lights should be treated as "for indication only" devices.

Note:

While every effort is made to ensure that the above guidelines are accurate, no responsibility can be accepted for failure to apply good engineering practice to machinery design and use of Honeywell products. Never apply any of the procedures outlined above on live circuits. Ensure that testing of changes is carried out with no risk of injury during tests. These guidelines are produced to help our customers make the right choices in applying our Limit Switches to general applications. Contact your local Honeywell representative if you have any difficulties.

MICRO SWITCH Global Limit Switches, GLA Series

REPLACEMENT PARTS - Levers

	Catalog Listing	Rod/Roller Material	Rod/Roller Dia. mm [in]	Roller Width mm [in]
Fixed length lever; 38,1 mm [1.5 in] radius				
	GLZ51A	Nylon	19,0 [0.75]	6,35 [0.25]
	GLZ51B	Steel	19,0 [0.75]	6,35 [0.25]
	GLZ51C	Nylon	25,4 [1.00]	12,7 [0.50]
	GLZ51E	Bronze	19,0 [0.75]	6,35 [0.25]
	GLZ51T	SST	19,0 [0.75]	9,5 [0.38]
	GLZ51Y	Rubber	50,0 [1.97]	10,0 [0.39]
Adjustable length lever; 38,1 to 89,0 mm [1.5 to 3.5 in] radius				
	GLZ52A	Nylon	19,0 [0.75]	6,35 [0.25]
	GLZ52B	Steel	19,0 [0.75]	6,35 [0.25]
	GLZ52D	Nylon	38,1 [1.50]	6,35 [0.25]
	GLZ52E	Nylon	19,0 [0.75]	33,1 [1.30]
	GLZ52W	Rubber	40,7 [1.60]	12,7 [0.50]
	GLZ52Y	Rubber	50,0 [1.97]	10,0 [0.39]
Fixed length yoke lever; 38,1 mm [1.5in] radius				
	GLZ53	No rollers	n/a	n/a
	GLZ53A	Nylon	19,0 [0.75]	6,35 [0.25]
	GLZ53B	Steel	19,0 [0.75]	6,35 [0.25]
	GLZ53E	Bronze	19,0 [0.75]	6,35 [0.25]
Adjustable rod levers				
	GLZ54	Hub only	n/a	n/a
	GLZ54J	Alum. rod 200 mm [7.9 in]	3,17 mm [0.125 in]	n/a
	GLZ54K	Alum. rod 140 mm [5.51 in]	3,17 mm [0.125 in]	n/a
	GLZ54N	SST rod 318 mm [12.5 in]	3,17 mm [0.125 in]	n/a
Fixed length offset lever; 38,1 mm [1.5 in] radius				
	GLZ55A	Nylon	19,0 [0.75]	6,35 [0.25]
	GLZ55B	Steel	19,0 [0.75]	6,35 [0.25]
	GLZ55E	Bronze	19,0 [0.75]	6,35 [0.25]
Fixed length spring rod				
	GLZ68	Delrin rod, 305 mm [12.0 in]	6,35 [0.25]	n/a

REPLACEMENT PARTS - Basic Switches

Basic Switch Code	GLA Body	GLF Body (1 LED)	GLH Body (2 LEDs)
01; 1NC/1NO, snap action	GLZ301	GLZ301	GLZ301
03; 1NC/1NO, slow action BBM	GLZ303	GLZ303	GLZ303
04; 1NC/1NO, slow action MBB	GLZ304	GLZ304	GLZ304
06; 2NC, Slow action	GLZ306	GLZ306	GLZ306
07; 1NC/1NO, snap action, gold contacts	GLZ307	GLZ307	GLZ307
20; 2NC/2NO, snap action	GLZ320	-	-
21; 2NC/2NO, snap action, sequence	GLZ321	-	-
22; 2NC/2NO, snap action, gold contacts	GLZ322	-	-
24; 2NC/2NO, snap action, use with LED body	-	GLZ324	GLZ324
26; 2NC/2NO, snap action, center neutral	GLZ326	-	-
32; 2NC/2NO, snap action, gold-plated contacts, use with LED body	-	GLZ332	GLZ332
33; 1NC/1NO, slow action BBM, gold-plated contacts	GLZ333	GLZ333	GLZ333
34; 1NC/1NO, slow action, MBB, gold plated contacts	GLZ334	GLZ334	GLZ334
36; 2NC, slow action, gold-plated contacts	GLZ336	GLZ336	GLZ336

MICRO SWITCH Global Limit Switches, GLA Series

REPLACEMENT PARTS - Heads

Head type	GLA	GLB	GLF	GLG	GLH
A; Side rotary, less lever	GLZ1AA	GLZ1AA	GLZ1AA	GLZ1AA	GLZ1AA
B; Top pin plunger	GLZ1AB	GLZ1AB	GLZ1AB	GLZ1AB	GLZ1AB
C; Top roller plunger	GLZ1AC	GLZ1AC	GLZ1AC	GLZ1AC	GLZ1AC
D; Top roller lever	GLZ1AD	GLZ1AD	GLZ1AD	GLZ1AD	GLZ1AD
E7A; Wobble plastic rod, 150 mm	GLZ1AE7A	GLZ1AE7A	GLZ1AE7A	GLZ1AE7A	GLZ1AE7A
E7B; Wobble sst coil spring, 141 mm	GLZ1AE7B	GLZ1AE7B	GLZ1AE7B	GLZ1AE7B	GLZ1AE7B
E7D; Wobble sst wire, 165 mm	GLZ1AE7D	GLZ1AE7D	GLZ1AE7D	GLZ1AE7D	GLZ1AE7D
K8A; Cat whisker, 140 mm sst wire	GLZ1AK8A	GLZ1AK8A	GLZ1AK8A	GLZ1AK8A	GLZ1AK8A
K8B; Cat whisker, 190 mm sst wire	GLZ1AK8B	GLZ1AK8B	GLZ1AK8B	GLZ1AK8B	GLZ1AK8B
K8C; Cat whisker, sst coil spring	GLZ1AK8C	GLZ1AK8C	GLZ1AK8C	GLZ1AK8C	GLZ1AK8C

ADDITIONAL MATERIALS

The following associated literature is available at sensing.honeywell.com:

- Product range guide
- Product application-specific information
 - Sensors and switches in front loaders
 - Sensors and switches in mobile cranes
 - Sensors and switches in oil rig applications

⚠ WARNING **PERSONAL INJURY**

DO NOT USE these products as safety or emergency stop devices or in any other application where failure of the product could result in personal injury.

Failure to comply with these instructions could result in death or serious injury.

⚠ WARNING **MISUSE OF DOCUMENTATION**

- The information presented in this product sheet is for reference only. Do not use this document as a product installation guide.
- Complete installation, operation, and maintenance information is provided in the instructions supplied with each product.

Failure to comply with these instructions could result in death or serious injury.

For more information

Honeywell Sensing and Internet of Things services its customers through a worldwide network of sales offices and distributors. For application assistance, current specifications, pricing or the nearest Authorized Distributor, visit sensing.honeywell.com or call:

Asia Pacific	+65 6355-2828
Europe	+44 (0) 1698 481481
USA/Canada	+1-800-537-6945

Honeywell Sensing and Internet of Things

9680 Old Bailes Road
Fort Mill, SC 29707
www.honeywell.com

Warranty/Remedy

Honeywell warrants goods of its manufacture as being free of defective materials and faulty workmanship during the applicable warranty period. Honeywell's standard product warranty applies unless agreed to otherwise by Honeywell in writing; please refer to your order acknowledgment or consult your local sales office for specific warranty details. If warranted goods are returned to Honeywell during the period of coverage, Honeywell will repair or replace, at its option, without charge those items that Honeywell, in its sole discretion, finds defective. **The foregoing is buyer's sole remedy and is in lieu of all other warranties, expressed or implied, including those of merchantability and fitness for a particular purpose. In no event shall Honeywell be liable for consequential, special, or indirect damages.**

While Honeywell may provide application assistance personally, through our literature and the Honeywell web site, it is buyer's sole responsibility to determine the suitability of the product in the application.

Specifications may change without notice. The information we supply is believed to be accurate and reliable as of this writing. However, Honeywell assumes no responsibility for its use.



Компания «ЭлектроПласт» предлагает заключение долгосрочных отношений при поставках импортных электронных компонентов на взаимовыгодных условиях!

Наши преимущества:

- Оперативные поставки широкого спектра электронных компонентов отечественного и импортного производства напрямую от производителей и с крупнейших мировых складов;
- Поставка более 17-ти миллионов наименований электронных компонентов;
- Поставка сложных, дефицитных, либо снятых с производства позиций;
- Оперативные сроки поставки под заказ (от 5 рабочих дней);
- Экспресс доставка в любую точку России;
- Техническая поддержка проекта, помощь в подборе аналогов, поставка прототипов;
- Система менеджмента качества сертифицирована по Международному стандарту ISO 9001;
- Лицензия ФСБ на осуществление работ с использованием сведений, составляющих государственную тайну;
- Поставка специализированных компонентов (Xilinx, Altera, Analog Devices, Intersil, Interpoint, Microsemi, Aeroflex, Peregrine, Syfer, Eurofarad, Texas Instrument, Miteq, Cobham, E2V, MA-COM, Hittite, Mini-Circuits, General Dynamics и др.);

Помимо этого, одним из направлений компании «ЭлектроПласт» является направление «Источники питания». Мы предлагаем Вам помощь Конструкторского отдела:

- Подбор оптимального решения, техническое обоснование при выборе компонента;
- Подбор аналогов;
- Консультации по применению компонента;
- Поставка образцов и прототипов;
- Техническая поддержка проекта;
- Защита от снятия компонента с производства.



Как с нами связаться

Телефон: 8 (812) 309 58 32 (многоканальный)

Факс: 8 (812) 320-02-42

Электронная почта: org@eplast1.ru

Адрес: 198099, г. Санкт-Петербург, ул. Калинина, дом 2, корпус 4, литера А.