

# Miniature Basic Switch D3V

## Reliable Basic Switch with External Lever

- Available by 0.1 A, 6 A, 11 A, 16 A and 21 A models, all with self-cleaning contacts. 0.1 A utilizes gold alloy crossbar contacts for high reliability at low loads.
- Available with internally or externally fitted levers, and 2 fixing positions for external levers.
- Conforms to EN61058-1 UL1054.
- High Temperature models rated up to 200°C (D3V-6, D3V-01) and 155°C (D3V-11) are available.
- RoHS Compliant.

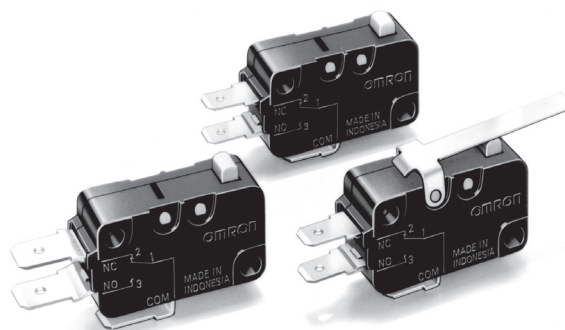

## Ordering Information

### Model Number Legend

D3V -             -          -    -    -   

1 2 3 4 5 6 7 8 9 10

#### 1. Ratings

- 21: 20 (4) A at 250 VAC
- 16: 16 (3) A at 250 VAC
- 11: 11 (3) A at 250 VAC
- 6: 6 (2) A at 250 VAC
- 01: 0.1 A at 125 VAC

#### 2. Contact Gap

- None: 1 mm (F gap)
- G: 0.5 mm (G gap)

#### 3. Actuator

- None: Pin plunger
- 1: Short hinge lever
- 2: Hinge lever
- 3: Long hinge lever
- 4: Simulated roller lever
- 5: Short hinge roller lever
- 6: Hinge roller lever

#### 4. Hinge Position

- None: Internal / Far from Plunger
- M: External / Far from Plunger
- K: External / Near Plunger

#### 5. Contact Form

- 1: SPDT
- 2: SPST-NC
- 3: SPST-NO

#### 6. Terminals

- A: Solder terminals
- C2: Quick-connect terminal (#187)
- C: Quick-connect terminal (#250)
- C6: RAST5 terminal (#250)

#### 7. Maximum Operating Force

- 5: 200 gf
- 4A: 125 gf
- 4: 100 gf
- 3: 50 gf
- 2: 25 gf

**Note:** These OF values are for the pin plunger models.

#### 8. Enclosure Material

- None: Standard
- T: High Temperature  
200°C for D3V-6, D3V-01  
155°C for D3V-11

W2: EN60695-2-11/-12 Approved  
(Glow wire flammability test method with PTI = 250)

#### 9. Mounting Hole Size

- None: 3.1 mm
- K: 2.9 mm

#### 10. Special Code

- None: Standard
- H: High Temperature (125°C)
- E: Special Rating: 21 (8) A  
(D3V-21, only)







## Available Combinations

Heat resistance	Terminals	Model	D3V-16			D3V-11					D3V-6			D3V-01	
		Rated current	16 A			11 A					6 A			0.1 A	
		OF	200 gf	100 gf	200 gf	100 gf			50 gf	200 gf	100 gf	50 gf	50 gf	25 gf	
		Contact gap	G 0.5 mm	F/G 1 mm or 0.5 mm	F/G 1 mm or 0.5 mm	F 1 mm	G 0.5 mm	F 1 mm	G 0.5 mm	G 0.5 mm	F/G 1 mm or 0.5 mm	F 1 mm	G 0.5 mm	G 0.5 mm	F/G 1 mm or 0.5 mm
Standard (85°C)	#187													○	○
	#250	○												○	○
	RAST5													○	○
Standard (105°C)	#187		○	○	○	○	○	○	○	○	○	○	○		
	#250		○	○	○	○	○	○	○	○	○	○	○		
	RAST5								○			○			
EN60695-2-11 approved W2: 85°C	#187													○	○
	#250													○	○
														○	○
EN60695-2-11 approved W2: 105°C	#187		○												
	#250		○	○	○		○				○		○		
	RAST5								○						
High temperature H: 125°C	#187		○	○	○	○	○	○	○	○	○	○	○		
	#250		○	○	○	○	○	○	○	○	○	○	○		
	RAST5														
High temperature T: 155°C	#187				○	○	○	○	○						
	#250				○	○	○	○	○						
	RAST5								○						
High temperature T: 200°C	#187									○	○	○	○	○	○
	#250									○	○	○	○	○	○
	RAST5											○	○		







Note: 1. ○: Available model.  
2. Consult OMRON for specific models with standard approval.

## List of Models







### 21 A (OF: 125 gf)

Actuator	Hinge position (far from plunger)	Contact form		
		SPDT	SPST-NC	SPST-NO
Pin plunger 	---	D3V-21G-1□4A-D-Ñ	D3V-21G-2□4A-D-Ñ	D3V-21G-3□4A-D-Ñ
Short hinge lever 	Internal	D3V-21G1-1□4A-D-Ñ	D3V-21G1-2□4A-D-Ñ	D3V-21G1-3□4A-D-Ñ
	External (M)	D3V-21G1M-1□4A-D-Ñ	D3V-21G1M-2□4A-D-Ñ	D3V-21G1M-3□4A-D-Ñ
Hinge lever 	Internal	D3V-21G2-1□4A-D-Ñ	D3V-21G2-2□4A-D-Ñ	D3V-21G2-3□4A-D-Ñ
	External (M)	D3V-21G2M-1□4A-D-Ñ	D3V-21G2M-2□4A-D-Ñ	D3V-21G2M-3□4A-D-Ñ
Long hinge lever 	Internal	D3V-21G3-1□4A-D-Ñ	D3V-21G3-2□4A-D-Ñ	D3V-21G3-3□4A-D-Ñ
	External (M)	D3V-21G3M-1□4A-D-Ñ	D3V-21G3M-2□4A-D-Ñ	D3V-21G3M-3□4A-D-Ñ
Simulated roller lever 	Internal	D3V-21G4-1□4A-D-Ñ	D3V-21G4-2□4A-D-Ñ	D3V-21G4-3□4A-D-Ñ
	External (M)	D3V-21G4M-1□4A-D-Ñ	D3V-21G4M-2□4A-D-Ñ	D3V-21G4M-3□4A-D-Ñ
Short hinge roller lever 	Internal	D3V-21G5-1□4A-D-Ñ	D3V-21G5-2□4A-D-Ñ	D3V-21G5-3□4A-D-Ñ
	External (M)	D3V-21G5M-1□4A-D-Ñ	D3V-21G5M-2□4A-D-Ñ	D3V-21G5M-3□4A-D-Ñ
Hinge roller lever 	Internal	D3V-21G6-1□4A-D-Ñ	D3V-21G6-2□4A-D-Ñ	D3V-21G6-3□4A-D-Ñ
	External (M)	D3V-21G6M-1□4A-D-Ñ	D3V-21G6M-2□4A-D-Ñ	D3V-21G6M-3□4A-D-Ñ







16 A (OF: 200 gf)

Actuator	Hinge position (far from plunger)	Contact form		
		SPDT	SPST-NC	SPST-NO
Pin plunger 	---	D3V-16-1□5●-D-Ñ	D3V-16-2□5●-D-Ñ	D3V-16-3□5●-D-Ñ
Short hinge lever 	Internal	D3V-161-1□5●-D-Ñ	D3V-161-2□5●-D-Ñ	D3V-161-3□5●-D-Ñ
	External (M)	D3V-161M-1□5●-D-Ñ	D3V-161M-2□5●-D-Ñ	D3V-161M-3□5●-D-Ñ
Hinge lever 	Internal	D3V-162-1□5●-D-Ñ	D3V-162-2□5●-D-Ñ	D3V-162-3□5●-D-Ñ
	External (M)	D3V-162M-1□5●-D-Ñ	D3V-162M-2□5●-D-Ñ	D3V-162M-3□5●-D-Ñ
Long hinge lever 	Internal	D3V-163-1□5●-D-Ñ	D3V-163-2□5●-D-Ñ	D3V-163-3□5●-D-Ñ
	External (M)	D3V-163M-1□5●-D-Ñ	D3V-163M-2□5●-D-Ñ	D3V-163M-3□5●-D-Ñ
Simulated roller lever 	Internal	D3V-164-1□5●-D-Ñ	D3V-164-2□5●-D-Ñ	D3V-164-3□5●-D-Ñ
	External (M)	D3V-164M-1□5●-D-Ñ	D3V-164M-2□5●-D-Ñ	D3V-164M-3□5●-D-Ñ
Short hinge roller lever 	Internal	D3V-165-1□5●-D-Ñ	D3V-165-2□5●-D-Ñ	D3V-165-3□5●-D-Ñ
	External (M)	D3V-165M-1□5●-D-Ñ	D3V-165M-2□5●-D-Ñ	D3V-165M-3□5●-D-Ñ
Hinge roller lever 	Internal	D3V-166-1□5●-D-Ñ	D3V-166-2□5●-D-Ñ	D3V-166-3□5●-D-Ñ
	External (M)	D3V-166M-1□5●-D-Ñ	D3V-166M-2□5●-D-Ñ	D3V-166M-3□5●-D-Ñ

16 A (OF: 100 gf)

Actuator	Hinge position (far from plunger)	Contact form		
		SPDT	SPST-NC	SPST-NO
Pin plunger 	---	D3V-16-1□4●-D-Ñ	D3V-16-2□4●-D-Ñ	D3V-16-3□4●-D-Ñ
Short hinge lever 	Internal	D3V-161-1□4●-D-Ñ	D3V-161-2□4●-D-Ñ	D3V-161-3□4●-D-Ñ
	External (M)	D3V-161M-1□4●-D-Ñ	D3V-161M-2□4●-D-Ñ	D3V-161M-3□4●-D-Ñ
Hinge lever 	Internal	D3V-162-1□4●-D-Ñ	D3V-162-2□4●-D-Ñ	D3V-162-3□4●-D-Ñ
	External (M)	D3V-162M-1□4●-D-Ñ	D3V-162M-2□4●-D-Ñ	D3V-162M-3□4●-D-Ñ
Long hinge lever 	Internal	D3V-163-1□4●-D-Ñ	D3V-163-2□4●-D-Ñ	D3V-163-3□4●-D-Ñ
	External (M)	D3V-163M-1□4●-D-Ñ	D3V-163M-2□4●-D-Ñ	D3V-163M-3□4●-D-Ñ
Simulated roller lever 	Internal	D3V-164-1□4●-D-Ñ	D3V-164-2□4●-D-Ñ	D3V-164-3□4●-D-Ñ
	External (M)	D3V-164M-1□4●-D-Ñ	D3V-164M-2□4●-D-Ñ	D3V-164M-3□4●-D-Ñ
Short hinge roller lever 	Internal	D3V-165-1□4●-D-Ñ	D3V-165-2□4●-D-Ñ	D3V-165-3□4●-D-Ñ
	External (M)	D3V-165M-1□4●-D-Ñ	D3V-165M-2□4●-D-Ñ	D3V-165M-3□4●-D-Ñ
Hinge roller lever 	Internal	D3V-166-1□4●-D-Ñ	D3V-166-2□4●-D-Ñ	D3V-166-3□4●-D-Ñ
	External (M)	D3V-166M-1□4●-D-Ñ	D3V-166M-2□4●-D-Ñ	D3V-166M-3□4●-D-Ñ







11 A (OF: 200 gf)

Actuator	Hinge position (far from plunger)	Contact form		
		SPDT	SPST-NC	SPST-NO
Pin plunger 	---	D3V-11-1□5●-D-Ñ	D3V-11-2□5●-D-Ñ	D3V-11-3□5●-D-Ñ
Short hinge lever 	Internal	D3V-111-1□5●-D-Ñ	D3V-111-2□5●-D-Ñ	D3V-111-3□5●-D-Ñ
	External (M)	D3V-111M-1□5●-D-Ñ	D3V-111M-2□5●-D-Ñ	D3V-111M-3□5●-D-Ñ
Hinge lever 	Internal	D3V-112-1□5●-D-Ñ	D3V-112-2□5●-D-Ñ	D3V-112-3□5●-D-Ñ
	External (M)	D3V-112M-1□5●-D-Ñ	D3V-112M-2□5●-D-Ñ	D3V-112M-3□5●-D-Ñ
Long hinge lever 	Internal	D3V-113-1□5●-D-Ñ	D3V-113-2□5●-D-Ñ	D3V-113-3□5●-D-Ñ
	External (M)	D3V-113M-1□5●-D-Ñ	D3V-113M-2□5●-D-Ñ	D3V-113M-3□5●-D-Ñ
Simulated roller lever 	Internal	D3V-114-1□5●-D-Ñ	D3V-114-2□5●-D-Ñ	D3V-114-3□5●-D-Ñ
	External (M)	D3V-114M-1□5●-D-Ñ	D3V-114M-2□5●-D-Ñ	D3V-114M-3□5●-D-Ñ
Short hinge roller lever 	Internal	D3V-115-1□5●-D-Ñ	D3V-115-2□5●-D-Ñ	D3V-115-3□5●-D-Ñ
	External (M)	D3V-115M-1□5●-D-Ñ	D3V-115M-2□5●-D-Ñ	D3V-115M-3□5●-D-Ñ
Hinge roller lever 	Internal	D3V-116-1□5●-D-Ñ	D3V-116-2□5●-D-Ñ	D3V-116-3□5●-D-Ñ
	External (M)	D3V-116M-1□5●-D-Ñ	D3V-116M-2□5●-D-Ñ	D3V-116M-3□5●-D-Ñ



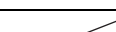



- The □ in the model number is for the terminal code.  
 A: Solder/quick-connect terminals (#187)  
 C2: Quick-connect terminals (#187)  
 C: Quick-connect terminals (#250)  
 C6: RAST5 terminals (#250)
- The ● in the model number is for the enclosure material  
 None: Standard  
 T: High Temperature (200°C for D3V-6/01, 155°C for D3V-11)  
 W2: EN60695-2-11/-12 conformity with PTI=250

- The Δ in the model number is for the mounting hole size.  
 None: 3.1 mm  
 K: 2.9 mm
- The ▽ in the model number is for the special code  
 None: Standard  
 H: High Temperature (125°C)  
 E: Special rating of 21A (8)A (for D3V-21 only)



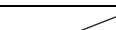



11 A (OF: 100 gf)

Actuator	Hinge position (far from plunger)	Contact form		
		SPDT	SPST-NC	SPST-NO
Pin plunger 	---	D3V-11-1□4●-D-Ñ	D3V-11-2□4●-D-Ñ	D3V-11-3□4●-D-Ñ
Short hinge lever 	Internal	D3V-111-1□4●-D-Ñ	D3V-111-2□4●-D-Ñ	D3V-111-3□4●-D-Ñ
	External (M)	D3V-111M-1□4●-D-Ñ	D3V-111M-2□4●-D-Ñ	D3V-111M-3□4●-D-Ñ
Hinge lever 	Internal	D3V-112-1□4●-D-Ñ	D3V-112-2□4●-D-Ñ	D3V-112-3□4●-D-Ñ
	External (M)	D3V-112M-1□4●-D-Ñ	D3V-112M-2□4●-D-Ñ	D3V-112M-3□4●-D-Ñ
Long hinge lever 	Internal	D3V-113-1□4●-D-Ñ	D3V-113-2□4●-D-Ñ	D3V-113-3□4●-D-Ñ
	External (M)	D3V-113M-1□4●-D-Ñ	D3V-113M-2□4●-D-Ñ	D3V-113M-3□4●-D-Ñ
Simulated roller lever 	Internal	D3V-114-1□4●-D-Ñ	D3V-114-2□4●-D-Ñ	D3V-114-3□4●-D-Ñ
	External (M)	D3V-114M-1□4●-D-Ñ	D3V-114M-2□4●-D-Ñ	D3V-114M-3□4●-D-Ñ
Short hinge roller lever 	Internal	D3V-115-1□4●-D-Ñ	D3V-115-2□4●-D-Ñ	D3V-115-3□4●-D-Ñ
	External (M)	D3V-115M-1□4●-D-Ñ	D3V-115M-2□4●-D-Ñ	D3V-115M-3□4●-D-Ñ
Hinge roller lever 	Internal	D3V-116-1□4●-D-Ñ	D3V-116-2□4●-D-Ñ	D3V-116-3□4●-D-Ñ
	External (M)	D3V-116M-1□4●-D-Ñ	D3V-116M-2□4●-D-Ñ	D3V-116M-3□4●-D-Ñ

11 A (OF: 50 gf)

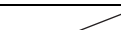
Actuator	Hinge position (far from plunger)	Contact form		
		SPDT	SPST-NC	SPST-NO
Pin plunger 	---	D3V-11G-1□3●-D-Ñ	D3V-11G-2□3●-D-Ñ	D3V-11G-3□3●-D-Ñ
Short hinge lever 	Internal	D3V-11G1-1□3●-D-Ñ	D3V-11G1-2□3●-D-Ñ	D3V-11G1-3□3●-D-Ñ
	External (M)	D3V-11G1M-1□3●-D-Ñ	D3V-11G1M-2□3●-D-Ñ	D3V-11G1M-3□3●-D-Ñ
Hinge lever 	Internal	D3V-11G2-1□3●-D-Ñ	D3V-11G2-2□3●-D-Ñ	D3V-11G2-3□3●-D-Ñ
	External (M)	D3V-11G2M-1□3●-D-Ñ	D3V-11G2M-2□3●-D-Ñ	D3V-11G2M-3□3●-D-Ñ
Long hinge lever 	Internal	D3V-11G3-1□3●-D-Ñ	D3V-11G3-2□3●-D-Ñ	D3V-11G3-3□3●-D-Ñ
	External (M)	D3V-11G3M-1□3●-D-Ñ	D3V-11G3M-2□3●-D-Ñ	D3V-11G3M-3□3●-D-Ñ
Simulated roller lever 	Internal	D3V-11G4-1□3●-D-Ñ	D3V-11G4-2□3●-D-Ñ	D3V-11G4-3□3●-D-Ñ
	External (M)	D3V-11G4M-1□3●-D-Ñ	D3V-11G4M-2□3●-D-Ñ	D3V-11G4M-3□3●-D-Ñ
Short hinge roller lever 	Internal	D3V-11G5-1□3●-D-Ñ	D3V-11G5-2□3●-D-Ñ	D3V-11G5-3□3●-D-Ñ
	External (M)	D3V-11G5M-1□3●-D-Ñ	D3V-11G5M-2□3●-D-Ñ	D3V-11G5M-3□3●-D-Ñ
Hinge roller lever 	Internal	D3V-11G6-1□3●-D-Ñ	D3V-11G6-2□3●-D-Ñ	D3V-11G6-3□3●-D-Ñ
	External (M)	D3V-11G6M-1□3●-D-Ñ	D3V-11G6M-2□3●-D-Ñ	D3V-11G6M-3□3●-D-Ñ

6 A (OF: 100 gf)

Actuator	Hinge position (far from plunger)	Contact form		
		SPDT	SPST-NC	SPST-NO
Pin plunger 	---	D3V-6-1□4●-D-Ñ	D3V-6-2□4●-D-Ñ	D3V-6-3□4●-D-Ñ
Short hinge lever 	Internal	D3V-61-1□4●-D-Ñ	D3V-61-2□4●-D-Ñ	D3V-61-3□4●-D-Ñ
	External (M)	D3V-61M-1□4●-D-Ñ	D3V-61M-2□4●-D-Ñ	D3V-61M-3□4●-D-Ñ
Hinge lever 	Internal	D3V-62-1□4●-D-Ñ	D3V-62-2□4●-D-Ñ	D3V-62-3□4●-D-Ñ
	External (M)	D3V-62M-1□4●-D-Ñ	D3V-62M-2□4●-D-Ñ	D3V-62M-3□4●-D-Ñ
Long hinge lever 	Internal	D3V-63-1□4●-D-Ñ	D3V-63-2□4●-D-Ñ	D3V-63-3□4●-D-Ñ
	External (M)	D3V-63M-1□4●-D-Ñ	D3V-63M-2□4●-D-Ñ	D3V-63M-3□4●-D-Ñ
Simulated roller lever 	Internal	D3V-64-1□4●-D-Ñ	D3V-64-2□4●-D-Ñ	D3V-64-3□4●-D-Ñ
	External (M)	D3V-64M-1□4●-D-Ñ	D3V-64M-2□4●-D-Ñ	D3V-64M-3□4●-D-Ñ
Short hinge roller lever 	Internal	D3V-65-1□4●-D-Ñ	D3V-65-2□4●-D-Ñ	D3V-65-3□4●-D-Ñ
	External (M)	D3V-65M-1□4●-D-Ñ	D3V-65M-2□4●-D-Ñ	D3V-65M-3□4●-D-Ñ
Hinge roller lever 	Internal	D3V-66-1□4●-D-Ñ	D3V-66-2□4●-D-Ñ	D3V-66-3□4●-D-Ñ
	External (M)	D3V-66M-1□4●-D-Ñ	D3V-66M-2□4●-D-Ñ	D3V-66M-3□4●-D-Ñ

• The □ in the model number is for the terminal code.

- A: Solder/quick-connect terminals (#187)
- C2: Quick-connect terminals (#187)
- C: Quick-connect terminals (#250)
- C6 RAST5 terminals (#250)

• The ● in the model number is for the enclosure material

- None: Standard
- T: High Temperature (200°C for D3V-6/-01, 155°C for D3V-11)
- W2: EN60695-2-11/-12 conformity with PTI=250







• The Δ in the model number is for the mounting hole size.

- None: 3.1 mm
- K: 2.9 mm







• The ▽ in the model number is for the special code

- None: Standard
- H: High Temperature (125°C)
- E: Special rating of 21A (8)A (for D3V-21 only)

6 A (OF: 50 gf)

Actuator	Hinge position (far from plunger)	Contact form		
		SPDT	SPST-NC	SPST-NO
Pin plunger 	---	D3V-6G-1□3-●-D-Ñ	D3V-6G-2□3-●-D-Ñ	D3V-6G-3□3-●-D-Ñ
Short hinge lever 	Internal	D3V-6G1-1□3-●-D-Ñ	D3V-6G1-2□3-●-D-Ñ	D3V-6G1-3□3-●-D-Ñ
	External (M)	D3V-6G1M-1□3-●-D-Ñ	D3V-6G1M-2□3-●-D-Ñ	D3V-6G1M-3□3-●-D-Ñ
Hinge lever 	Internal	D3V-6G2-1□3-●-D-Ñ	D3V-6G2-2□3-●-D-Ñ	D3V-6G2-3□3-●-D-Ñ
	External (M)	D3V-6G2M-1□3-●-D-Ñ	D3V-6G2M-2□3-●-D-Ñ	D3V-6G2M-3□3-●-D-Ñ
Long hinge lever 	Internal	D3V-6G3-1□3-●-D-Ñ	D3V-6G3-2□3-●-D-Ñ	D3V-6G3-3□3-●-D-Ñ
	External (M)	D3V-6G3M-1□3-●-D-Ñ	D3V-6G3M-2□3-●-D-Ñ	D3V-6G3M-3□3-●-D-Ñ
Simulated roller lever 	Internal	D3V-6G4-1□3-●-D-Ñ	D3V-6G4-2□3-●-D-Ñ	D3V-6G4-3□3-●-D-Ñ
	External (M)	D3V-6G4M-1□3-●-D-Ñ	D3V-6G4M-2□3-●-D-Ñ	D3V-6G4M-3□3-●-D-Ñ
Short hinge roller lever 	Internal	D3V-6G5-1□3-●-D-Ñ	D3V-6G5-2□3-●-D-Ñ	D3V-6G5-3□3-●-D-Ñ
	External (M)	D3V-6G5M-1□3-●-D-Ñ	D3V-6G5M-2□3-●-D-Ñ	D3V-6G5M-3□3-●-D-Ñ
Hinge roller lever 	Internal	D3V-6G6-1□3-●-D-Ñ	D3V-6G6-2□3-●-D-Ñ	D3V-6G6-3□3-●-D-Ñ
	External (M)	D3V-6G6M-1□3-●-D-Ñ	D3V-6G6M-2□3-●-D-Ñ	D3V-6G6M-3□3-●-D-Ñ

01 A (OF: 50 gf)

Actuator	Hinge position (far from plunger)	Contact form		
		SPDT	SPST-NC	SPST-NO
Pin plunger 	---	D3V-01-1□3-●-D-Ñ	D3V-01-2□3-●-D-Ñ	D3V-01-3□3-●-D-Ñ
Short hinge lever 	Internal	D3V-011-1□3-●-D-Ñ	D3V-011-2□3-●-D-Ñ	D3V-011-3□3-●-D-Ñ
	External (M)	D3V-011M-1□3-●-D-Ñ	D3V-011M-2□3-●-D-Ñ	D3V-011M-3□3-●-D-Ñ
Hinge lever 	Internal	D3V-012-1□3-●-D-Ñ	D3V-012-2□3-●-D-Ñ	D3V-012-3□3-●-D-Ñ
	External (M)	D3V-012M-1□3-●-D-Ñ	D3V-012M-2□3-●-D-Ñ	D3V-012M-3□3-●-D-Ñ
Long hinge lever 	Internal	D3V-013-1□3-●-D-Ñ	D3V-013-2□3-●-D-Ñ	D3V-013-3□3-●-D-Ñ
	External (M)	D3V-013M-1□3-●-D-Ñ	D3V-013M-2□3-●-D-Ñ	D3V-013M-3□3-●-D-Ñ
Simulated roller lever 	Internal	D3V-014-1□3-●-D-Ñ	D3V-014-2□3-●-D-Ñ	D3V-014-3□3-●-D-Ñ
	External (M)	D3V-014M-1□3-●-D-Ñ	D3V-014M-2□3-●-D-Ñ	D3V-014M-3□3-●-D-Ñ
Short hinge roller lever 	Internal	D3V-015-1□3-●-D-Ñ	D3V-015-2□3-●-D-Ñ	D3V-015-3□3-●-D-Ñ
	External (M)	D3V-015M-1□3-●-D-Ñ	D3V-015M-2□3-●-D-Ñ	D3V-015M-3□3-●-D-Ñ
Hinge roller lever 	Internal	D3V-016-1□3-●-D-Ñ	D3V-016-2□3-●-D-Ñ	D3V-016-3□3-●-D-Ñ
	External (M)	D3V-016M-1□3-●-D-Ñ	D3V-016M-2□3-●-D-Ñ	D3V-016M-3□3-●-D-Ñ

01 A (OF: 25 gf)

Actuator	Hinge position (far from plunger)	Contact form		
		SPDT	SPST-NC	SPST-NO
Pin plunger 	---	D3V-01-1□2-●-D-Ñ	D3V-01-2□2-●-D-Ñ	D3V-01-3□2-●-D-Ñ

- The □ in the model number is for the terminal code.
  - A: Solder/quick-connect terminals (#187)
  - C2: Quick-connect terminals (#187)
  - C: Quick-connect terminals (#250)
  - C6: RAST5 terminals (#250)
- The ● in the model number is for the enclosure material
  - None: Standard
  - T: High Temperature (200°C for D3V-6/-01, 155°C for D3V-11)
  - W2: EN60695-2-11/-12 conformity with PTI=250

- The Δ in the model number is for the mounting hole size.
  - None: 3.1 mm
  - K: 2.9 mm
- The ▽ in the model number is for the special code
  - None: Standard
  - H: High Temperature (125°C)
  - E: Special rating of 21A (8)A (for D3V-21 only)

# Specifications

## ■ Ratings

Type	Rated voltage	Non-inductive load				Inductive load			
		Resistive load		Lamp load		Inductive load		Motor load	
		NC	NO	NC	NO	NC	NO	NC	NO
D3V-21	250 VAC	21 A		3 A		12 A		4 A	
	8 VDC	21 A		5 A		12 A		7 A	
	30 VDC	14 A		5 A		12 A		5 A	
	125 VDC	0.6 A		0.1 A		0.6 A		0.1 A	
	250 VDC	0.3 A		0.05 A		0.3 A		0.05 A	
D3V-16	250 VAC	16 A		2 A		10 A		3 A	
	8 VDC	16 A		4 A		10 A		6 A	
	30 VDC	10 A		4 A		10 A		4 A	
	125 VDC	0.6 A		0.1 A		0.6 A		0.1 A	
	250 VDC	0.3 A		0.05 A		0.3 A		0.05 A	
D3V-11	250 VAC	11 A		1.5 A		6 A		2 A	
	8 VDC	11 A		3 A		6 A		3 A	
	30 VDC	6 A		3 A		6 A		3 A	
	125 VDC	0.6 A		0.1 A		0.6 A		0.1 A	
	250 VDC	0.3 A		0.05 A		0.3 A		0.05 A	
D3V-6	250 VAC	6 A		3 A		4 A		---	
	8 VDC	6 A		3 A		4 A		---	
	30 VDC	6 A		3 A		4 A		---	
	125 VDC	0.4 A		0.1 A		0.4 A		---	
	250 VDC	0.3 A		0.05 A		0.2 A		---	
D3V-01	125 VAC	0.1 A		---		---		---	
	8 VDC	0.1 A		---		---		---	
	30 VDC	0.1 A		---		---		---	

**Note:** 1. The above current values are the normal current values of models with a contact gap of 1 mm (gap F), which vary with the normal current values of models with a contact gap of 0.5 mm (gap G).

2. Inductive load has a power factor of 0.4 min. (AC) and a time constant of 7 ms max. (DC).
3. Lamp load has an inrush current of 10 times the steady-state current.
4. Motor load has an inrush current of 6 times the steady-state current.
5. The ratings values apply under the following test conditions: Ambient temperature: 20±2°C, Ambient humidity: 65±5%, Operating frequency: 30 operations/min

## ■ Approved Standards

UL1054 (File No. E41515)

CSA C22.2 No.55 (File No. LR21642)

(Only standard ratings are listed.)

Rated voltage	D3V-21G	D3V-16	D3V-16G	D3V-11	D3V-11G	D3V-6	D3V-6G	D3V-01
125 VAC	3/4 HP	16 A, 1/2 HP	16 A, 1/2 HP	11 A, 1/2 HP	11 A, 1/2 HP	6 A, 1/4 HP	6 A, 1/4 HP	0.1 A
250 VAC	20.1 A, 3/4 HP	16 A, 1/2 HP	16 A, 1/2 HP	11 A, 1/2 HP	11 A, 1/2 HP	6 A, 1/4 HP	6 A, 1/4 HP	---
125 VDC	---	0.6 A	0.1 A	0.6 A	0.1 A	---	---	---
250 VDC	---	0.3 A	---	0.3 A	---	---	---	---

EN 61058-1: 1992+A1: 1993 (License No. 119151L)

Rated voltage	D3V-21G	D3V-16	D3V-11	D3V-6	D3V-01
125 VAC	---	---	---	---	0.1 A
250 VAC	20 (4) A	16 (3) A	11 (3) A	6 (2) A	---
250 VAC	21 (8) A**				

Testing conditions: 50,000 operations, T85 (0°C to 85°C) for D3V-21/D3V-01, T105 (0°C to 105°C) for D3V-16/D3V-11/D3V-6 and T200 (0 to 200°C) for D3V-6/01 with suffix "T", T155 (0 to 155°C) for D3V-11 with suffix "T".

\*\*Testing conditions: 10,000 operations, T85 (0°C to 85°C)

EN 60695-2-11 Ed.2, EN 60695-2-12 Ed.2 - - Glow-wire flammability test methods

Rated voltage	D3V-16	D3V-11	D3V-6	D3V-01
125 VAC	---	---	---	0.1 A
250 VAC	16 (3) A	11 (3) A	6 (2) A	---

## ■ Characteristics

<b>Operating speed</b>	0.1 mm to 1 m/s (plunger models)
<b>Operating frequency</b>	Mechanical: 600 operations/min Electrical: 60 operations/min
<b>Insulation resistance</b>	100 MΩ min. (at 500 VDC)
<b>Contact resistance</b>	D3V-21: 50 mΩ max. D3V-16, D3V-11, D3V-6: 30 mΩ max. D3V-01, 50 gf versions: 50 mΩ max. 25 gf versions: 100 mΩ max.
<b>Dielectric strength (see note 2)</b>	1,000 VAC, 50/60 Hz for 1 min between terminals of the same polarity 2,000 VAC, 50/60 Hz for 1 min between current-carrying metal parts and ground, and between each terminal and non-current-carrying metal parts
<b>Vibration resistance (see note 3)</b>	Malfunction: 10 to 55 Hz, 1.5-mm double amplitude
<b>Shock resistance (see note 3)</b>	Destruction: 400 m/s <sup>2</sup> (approx. 40G) max. Malfunction: 100 m/s <sup>2</sup> (approx. 10G) max.
<b>Life expectancy</b>	Mechanical: 10,000,000 operations min. Electrical: D3V-21: 50,000 operations min. D3V-16: 100,000 operations min. D3V-11: 200,000 operations min. D3V-6, D3V-01: 500,000 operations min.
<b>Degree of protection</b>	IEC IP40
<b>Degree of protection against electric shock</b>	Class I
<b>Proof tracking index (PTI)</b>	250 (High Temperature type with suffix "-T": 175)
<b>Ambient operating temperature</b>	D3V-21: -25°C to 85°C with no icing D3V-16: -25°C to 105°C (High Temperature type "H": -25°C to 125°C) with no icing D3V-11: -25°C to 105°C (High Temperature types "H": -25°C to 125°C, "T": -25°C to 155°C) with no icing D3V-6: -25°C to 105°C (High Temperature types "H": -25°C to 125°C, "T": -25°C to 200°C) with no icing D3V-01: -25°C to 85°C (High Temperature type "T": -25°C to 200°C) with no icing
<b>Ambient operating humidity</b>	85% max. (for 5°C to 35°C)
<b>Weight</b>	Approx. 6.2 g (plunger models)

**Note:** 1. Data shown are of initial value.

2. The dielectric strength values shown in the table are for models with a Separator.

3. For plunger models, the above values apply for use at both the free position and total travel position. For lever models, they apply at the total travel position.

4. For testing conditions, contact your OMRON sales representative.

## ■ Contact Specifications

Item		D3V-21	D3V-16	D3V-11	D3V-6	D3V-01
Contact	Specification	Rivet				Crossbar
	Material	Silver alloy				Gold alloy
	Gap (standard value)	0.5 mm	1 mm (F gap type) or 0.5 mm (G gap type)			1.0 mm
Inrush current	NC	50 A max.	40 A max.	24 A max.	15 A max.	---
	NO					
Minimum applicable load		160 mA at 5 VDC				1 mA at 5 VDC

**Note:** Minimum applicable loads are indicated by N standard reference values. This value represents the failure rate at a 60% ( $\lambda_{60}$ ) reliability level (JIS C5003). The equation  $\lambda_{60}=0.5 \times 10^{-6} / \text{operations}$  indicates that a failure rate of 1/2,000,000 operations can be expected at a reliability level of 60%.

## ■ Contact Form

SPDT	SPST-NC	SPST-NO

# Dimensions

## ■ Terminals

**Note:** Unless otherwise specified, all units are in millimeters and a tolerance of  $\pm 0.4$  mm applies to all dimensions

Terminal type	Solder Terminal (A)	Quick-connect Terminal (#187) (C2)	Quick-connect Terminal (#250) (C)	Quick-connect RAST5 Terminals (#250)(C6)
COM	<p>Three, solder terminals</p>	<p>Three, quick-connect terminals (#187)</p>	<p>Three, quick-connect terminals (#250)</p>	<p>Three quick connect terminals (#250)</p>
Terminal dimensions	<p>Note: Indicates the length to the center of the 1.6-dia. holes</p>	<p>1.6-dia. terminal hole</p>	<p>1.65-dia. terminal hole</p>	<p>1.75-dia. terminal hole</p>

**Note:** The table above is for the SPDT contact specifications. Two terminals will be available for SPST-NO or SPST-NC contact specifications. For terminal positions, refer to the above *Contact Form*.

## ■ Mounting Holes

All switches may be panel mounted using M3 mounting screws with plane washers or spring washers to securely mount the switch. Tighten the screws to a torque of 0.39 to 0.59 N·m.

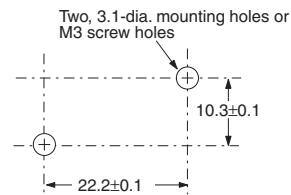

## ■ Dimensions and Operating Characteristics

- Note:**
- Unless otherwise specified, all units are in millimeters and a tolerance of  $\pm 0.4$  mm applies to all dimensions
  - The following illustrations and drawings are for quick-connect terminals (#187) (terminals C2). D3V models also incorporate terminals A, C, and C6, which are omitted from the following drawings. Refer to *Terminals* section for the dimensions of these terminals.
  - The □ in the model number is for the terminal code.
  - The Δ in the model number is for combinations of the enclosure material, the mounting hole size and the special code as indicated in the *Model Number Legend* and *Available Combinations* tables. The hole size in the following illustrations of models with a suffix "K" in the Δ is 2.9 mm.
  - The operating characteristics are for operation in the A direction ( ↓ ).

### Plunger Models

- D3V-21G-1□4A-Δ
- D3V-16-1□5-Δ
- D3V-11-1□5-Δ
- D3V-11-1□4-Δ
- D3V-6-1□4-Δ
- D3V-6G-1□3-Δ
- D3V-01-1□2-Δ
- D3V-01-1□3-Δ

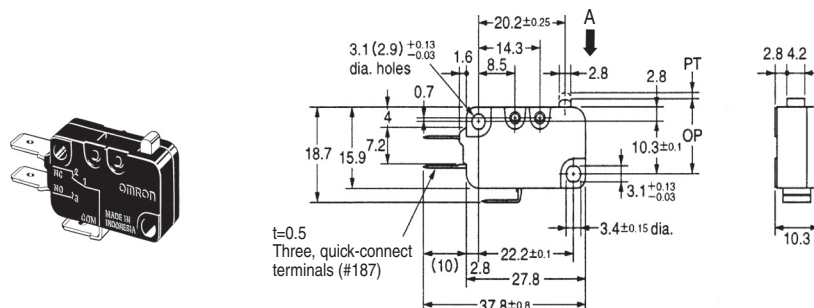

Model	D3V-21G-1□4A-Δ	D3V-16-1□5-Δ D3V-11-1□5-Δ	D3V-11-1□4-Δ D3V-6-1□4-Δ	D3V-6G-1□3-Δ	D3V-01-1□3-Δ	D3V-01-1□2-Δ
OF max.	125 gf	200 gf	100 gf	50 gf	50 gf	25 gf
RF min.	20 gf	50 gf	15 gf	5 gf	5 gf	3 gf
PT max.	1.2 mm	1.2 mm			1.2 mm	
OT min.	1.0 mm	1.0 mm			1.0 mm	
MD max.	0.3 mm	0.4 mm (F gap type) or 0.3 mm (G gap type)			0.4 mm	
OP	14.7±0.4 mm					



**Short Hinge Lever Models**

- D3V-21G1-1□4A-Δ
- D3V-161-1□5-Δ
- D3V-111-1□5-Δ
- D3V-111-1□4-Δ
- D3V-61-1□4-Δ
- D3V-6G1-1□3-Δ
- D3V-011-1□3-Δ

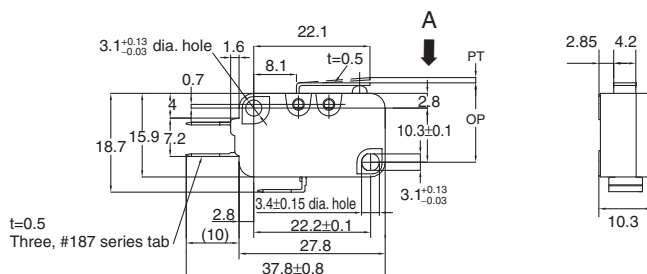
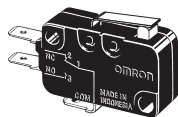

- D3V-21G1M-1□4A-Δ
- D3V-161M-1□5-Δ
- D3V-111M-1□5-Δ
- D3V-111M-1□4-Δ
- D3V-61M-1□4-Δ
- D3V-6G1M-1□3-Δ
- D3V-011M-1□3-Δ

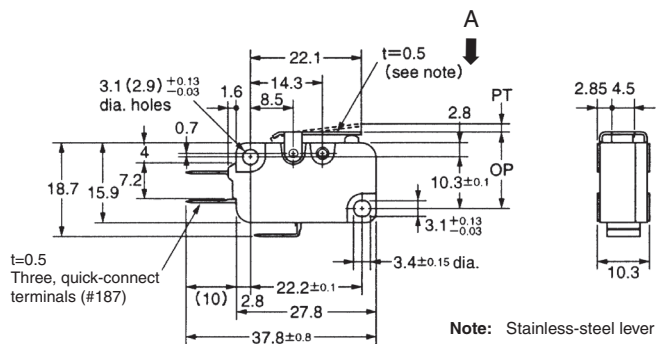

Model	D3V-21G1(M)-1□4A-Δ	D3V-161(M)-1□5-Δ D3V-111(M)-1□5-Δ	D3V-111(M)-1□4-Δ D3V-61(M)-1□4-Δ	D3V-6G1(M)-1□3-Δ	D3V-011(M)-1□3-Δ
OF max. RF min.	125 gf 20 gf	200 gf 50 gf	100 gf 15 gf	50 gf 5 gf	
PT max. OT min. MD max.	1.6 mm 0.8 mm 0.5 mm	1.6 mm 0.8 mm 0.6 mm (F gap type) or 0.5 mm (G gap type)			1.6 mm 0.8 mm 0.6 mm
OP	15.2 ± 0.5 mm				

- D3V-21G1K-1□4A-Δ
- D3V-161K-1□5-Δ
- D3V-111K-1□5-Δ
- D3V-111K-1□4-Δ
- D3V-61K-1□4-Δ
- D3V-6G1K-1□3-Δ
- D3V-011K-1□3-Δ

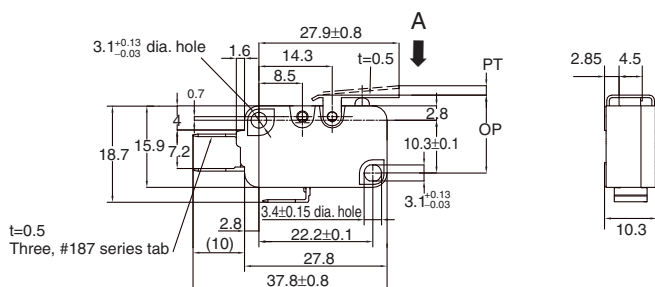
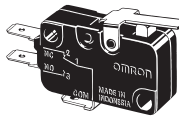

Model	D3V-21G1K-1□4A-Δ	D3V-161K-1□5-Δ D3V-111K-1□5-Δ	D3V-111K-1□4-Δ D3V-61K-1□4-Δ	D3V-6G1K-1□3-Δ	D3V-011K-1□3-Δ
OF max. RF min.	85 gf 8 gf	130 gf 16 gf	65 gf 8 gf	35 gf 4 gf	
PT max. OT min. MD max.	3.5 mm 1.1 mm 1.1 mm	3.5 mm 1.1 mm 1.2 mm (F gap type) or 1.1 mm (G gap type)			3.5 mm 1.1 mm 1.2 mm
OP	15.2 ± 1.2 mm				

### Hinge Lever Models

- D3V-21G2-1□4A-Δ
- D3V-162-1□5-Δ
- D3V-112-1□5-Δ
- D3V-112-1□4-Δ
- D3V-62-1□4-Δ
- D3V-6G2-1□3-Δ
- D3V-012-1□3-Δ

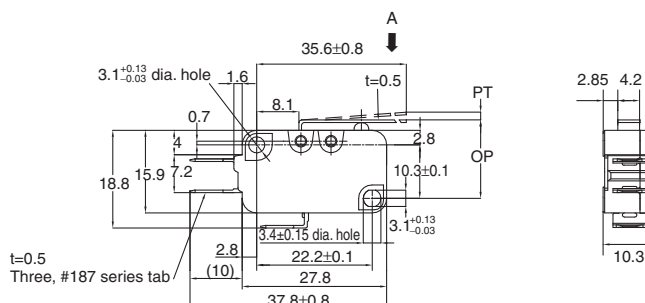
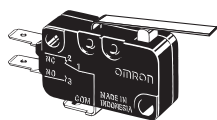

- D3V-21G2M-1□4A-Δ
- D3V-162M-1□5-Δ
- D3V-112M-1□5-Δ
- D3V-112M-1□4-Δ
- D3V-62M-1□4-Δ
- D3V-6G2M-1□3-Δ
- D3V-012M-1□3-Δ

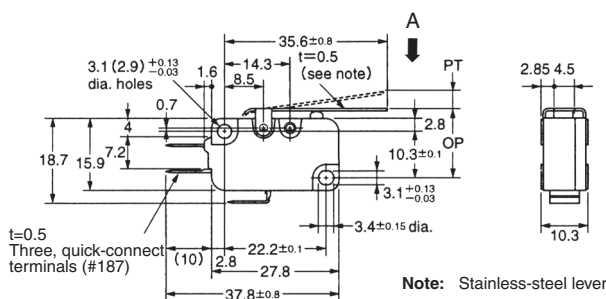

Model	D3V-21G2(M)-1□4A-Δ	D3V-162(M)-1□5-Δ D3V-112(M)-1□5-Δ	D3V-112(M)-1□4-Δ D3V-62(M)-1□4-Δ	D3V-6G2(M)-1□3-Δ	D3V-012(M)-1□3-Δ
OF max.	80 gf	125 gf	60 gf		30 gf
RF min.	6 gf	14 gf	6 gf		---
PT max.	4.0 mm	4.0 mm		4.0 mm	
OT min.	1.6 mm	1.6 mm		1.6 mm	
MD max.	0.8 mm	1.5 mm (F gap type) or 0.8 mm (G gap type)			1.5 mm
OP	15.2 ± 1.2 mm				

- D3V-21G2K-1□4A-Δ
- D3V-162K-1□5-Δ
- D3V-112K-1□5-Δ
- D3V-112K-1□4-Δ
- D3V-62K-1□4-Δ
- D3V-6G2K-1□3-Δ
- D3V-012K-1□3-Δ

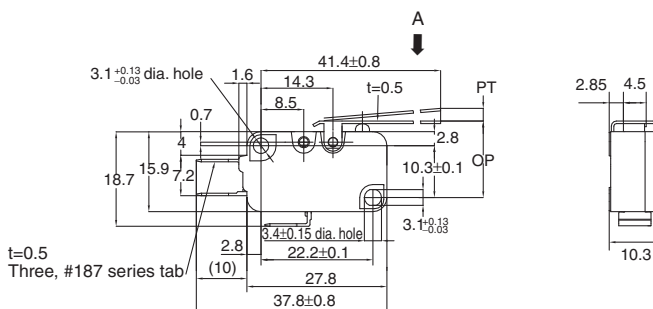

Model	D3V-21G2K-1□4A-Δ	D3V-162K-1□5-Δ D3V-112K-1□5-Δ	D3V-112K-1□4-Δ D3V-62K-1□4-Δ	D3V-6G2K-1□3-Δ	D3V-012K-1□3-Δ
OF max.	45 gf	70 gf	35 gf	20 gf	
RF min.	4 gf	8 gf	4 gf	---	
PT max.	6.0 mm	6.0 mm		6.0 mm	
OT min.	2.5 mm	2.5 mm		2.5 mm	
MD max.	1.3 mm	2.0 mm (F gap type) or 1.3 mm (G gap type)			2.0 mm
OP	15.2 ± 2.0 mm				

**Long Hinge Lever Models**

- D3V-21G3-1□4A-Δ
- D3V-163-1□5-Δ
- D3V-113-1□5-Δ
- D3V-113-1□4-Δ
- D3V-63-1□4-Δ
- D3V-6G3-1□3-Δ
- D3V-013-1□3-Δ

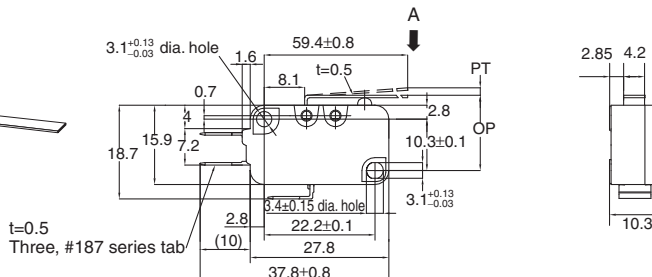

- D3V-21G3M-1□4A-Δ
- D3V-163M-1□5-Δ
- D3V-113M-1□5-Δ
- D3V-113M-1□4-Δ
- D3V-63M-1□4-Δ
- D3V-6G3M-1□3-Δ
- D3V-013M-1□3-Δ

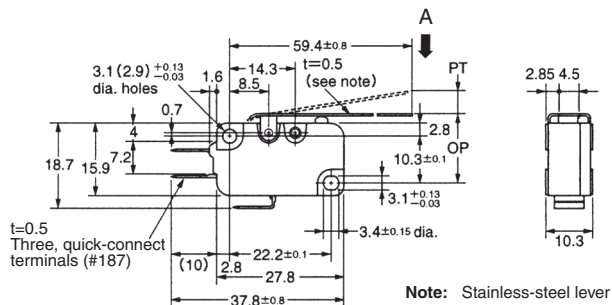

Model	D3V-21G3(M)-1□4A-D	D3V-163(M)-1□5-D D3V-113(M)-1□5-D	D3V-113(M)-1□4-D D3V-63(M)-1□4-D	D3V-6G3(M)-1□3-D	D3V-013(M)-1□3-D
OF max.	45 gf	70 gf	35 gf	20 gf	
RF min.	3 gf	6 gf	---	---	
PT max.	9.0 mm	9.0 mm	9.0 mm		9.0 mm
OT min.	2.0 mm	2.0 mm	3.2 mm		3.2 mm
MD max.	2.0 mm	2.8 mm (F gap type) or 2.0 mm (G gap type)		2.8 mm (F gap type) or 2.0 mm (G gap type)	
OP	15.2 <sup>+2.6</sup> / <sub>-3.2</sub> mm		15.2 ± 2.6 mm		

- D3V-21G3K-1□4A-Δ
- D3V-163K-1□5-Δ
- D3V-113K-1□5-Δ
- D3V-113K-1□4-Δ
- D3V-63K-1□4-Δ
- D3V-6G3K-1□3-Δ
- D3V-013K-1□3-Δ

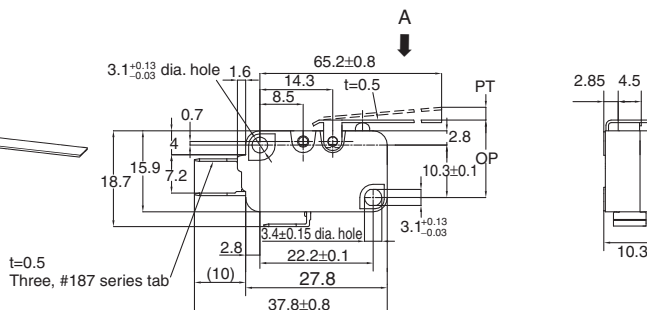

Model	D3V-21G3K-1□4A-D	D3V-163K-1□5-D D3V-113K-1□5-D	D3V-113K-1□4-D D3V-63K-1□4-D	D3V-6G3K-1□3-D	D3V-013K-1□3-D
OF max.	20 gf	35 gf	20 gf	10 gf	
RF min.	---	4 gf	---	---	
PT max.	15.0 mm	15.0 mm			15.0 mm
OT min.	4.0 mm	4.0 mm			4.0 mm
MD max.	3.0 mm	3.8 mm (F gap type) or 3.0 mm (G gap type)			3.8 mm
OP	15.2 ± 3.0 mm				

**Simulated Roller Lever Models**

- D3V-21G4-1□4A-Δ
- D3V-164-1□5-Δ
- D3V-114-1□5-Δ
- D3V-114-1□4-Δ
- D3V-64-1□4-Δ
- D3V-6G4-1□3-Δ
- D3V-014-1□3-Δ

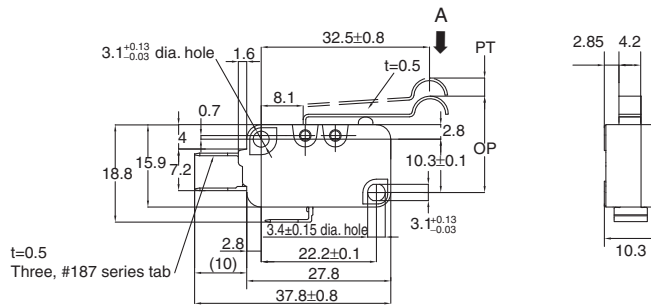
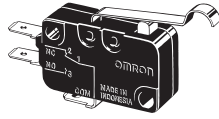

- D3V-21G4M-1□4A-Δ
- D3V-164M-1□5-Δ
- D3V-114M-1□5-Δ
- D3V-114M-1□4-Δ
- D3V-64M-1□4-Δ
- D3V-6G4M-1□3-Δ
- D3V-014M-1□3-Δ

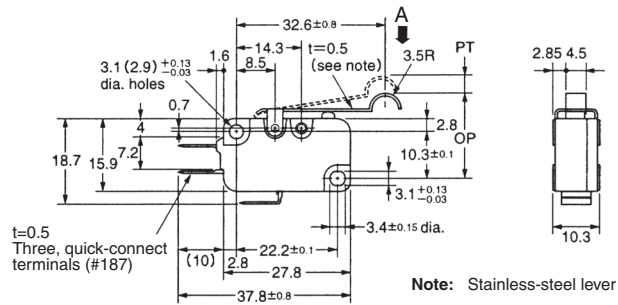
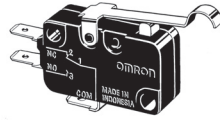

Model	D3V-21G4(M)-1□4A-Δ	D3V-164(M)-1□5-Δ D3V-114(M)-1□5-Δ	D3V-114(M)-1□4-Δ D3V-64(M)-1□4-Δ	D3V-6G4(M)-1□3-Δ	D3V-014(M)-1□3-Δ
OF max.	85 gf	125 gf	60 gf	30 gf	
RF min.	7 gf	14 gf	6 gf	---	
PT max.	4.0 mm	4.0 mm			4.0 mm
OT min.	1.6 mm	1.6 mm			1.6 mm
MD max.	1.4 mm	1.5 mm (F gap type) or 0.8 mm (G gap type)			1.5 mm
OP	18.7 ± 1.2 mm				

- D3V-21G4K-1□4A-Δ
- D3V-164K-1□5-Δ
- D3V-114K-1□5-Δ
- D3V-114K-1□4-Δ
- D3V-64K-1□4-Δ
- D3V-6G4K-1□3-Δ
- D3V-014K-1□3-Δ

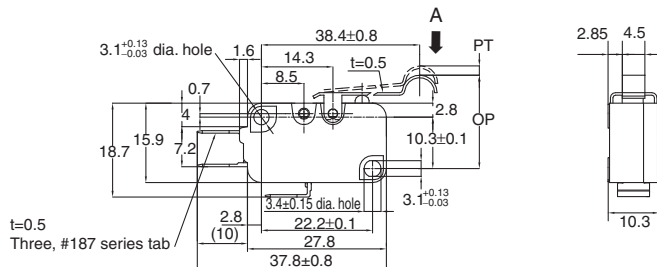

Model	D3V-21G4K-1□4A-D	D3V-164K-1□5-D D3V-114K-1□5-D	D3V-114K-1□4-D D3V-64K-1□4-D	D3V-6G4K-1□3-D	D3V-014K-1□3-D
OF max.	55 gf	75 gf	40 gf	20 gf	
RF min.	3 gf	10 gf	3 gf	---	
PT max.	8.0 mm	8.0 mm			8.0 mm
OT min.	1.5 mm	1.5 mm			1.5 mm
MD max.	3.0 mm	3.5 mm (F gap type) or 3.0 mm (G gap type)			3.5 mm
OP	18.7 ± 1.2 mm				

**Short Hinge Roller Lever Models**

- D3V-21G5-1□4A-Δ
- D3V-165-1□5-Δ
- D3V-115-1□5-Δ
- D3V-115-1□4-Δ
- D3V-65-1□4-Δ
- D3V-6G5-1□3-Δ
- D3V-015-1□3-Δ

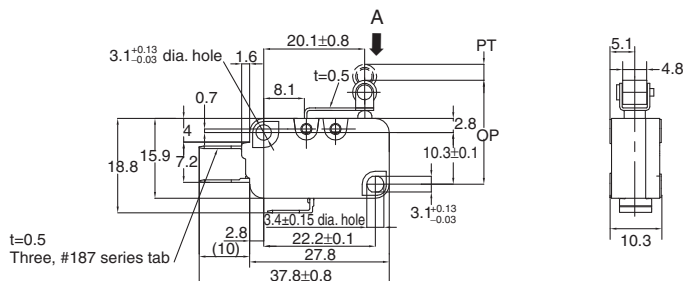
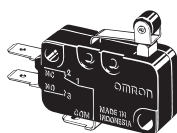

- D3V-21G5M-1□4A-Δ
- D3V-165M-1□5-Δ
- D3V-115M-1□5-Δ
- D3V-115M-1□4-Δ
- D3V-65M-1□4-Δ
- D3V-6G5M-1□3-Δ
- D3V-015M-1□3-Δ

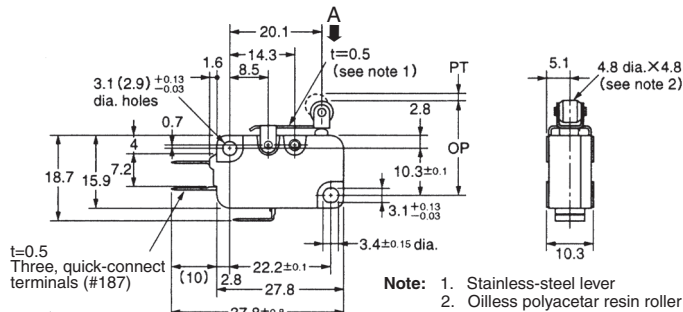
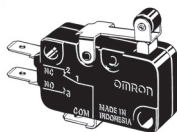

Model	D3V-21G5(M)-1□4A-Δ	D3V-165(M)-1□5-Δ D3V-115(M)-1□5-Δ	D3V-115(M)-1□4-Δ D3V-65(M)-1□4-Δ	D3V-6G5(M)-1□3-Δ	D3V-015(M)-1□3-Δ
OF max. RF min.	145 gf 20 gf	240 gf 50 gf	120 gf 15 gf		60 gf 6 gf
PT max. OT min. MD max.	1.6 mm 0.8 mm 0.5 mm	1.6 mm 0.8 mm 0.6 mm (F gap type) or 0.5 mm (G gap type)			1.6 mm 0.8 mm 0.6 mm
OP	20.7±0.6 mm				

- D3V-21G5K-1□4A-Δ
- D3V-165K-1□5-Δ
- D3V-115K-1□5-Δ
- D3V-115K-1□4-Δ
- D3V-65K-1□4-Δ
- D3V-6G5K-1□3-Δ
- D3V-015K-1□3-Δ

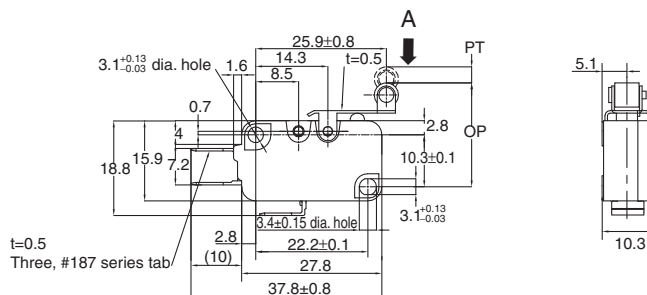
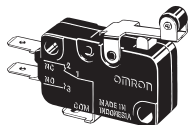

Model	D3V-21G5K-1□4A-D	D3V-165K-1□5-D D3V-115K-1□5-D	D3V-115K-1□4-D D3V-65K-1□4-D	D3V-6G5K-1□3-D	D3V-015K-1□3-D
OF max. RF min.	100 gf 8 gf	160 gf 15 gf	80 gf 8 gf		40 gf 4 gf
PT max. OT min. MD max.	2.6 mm 1.0 mm 8.0 mm	2.6 mm 1.0 mm 0.9 mm (F gap type) or 0.8 mm (G gap type)			2.6 mm 1.0 mm 0.9 mm
OP	20.7 ± 1.0 mm				

### Hinge Roller Lever Models

- D3V-21G6-1□4A-Δ
- D3V-166-1□5-Δ
- D3V-116-1□5-Δ
- D3V-116-1□4-Δ
- D3V-66-1□4-Δ
- D3V-6G6-1□3-Δ
- D3V-016-1□3-Δ

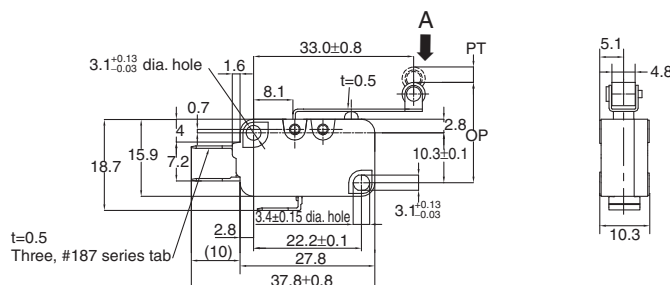

- D3V-21G6M-1□4A-Δ
- D3V-166M-1□5-Δ
- D3V-116M-1□5-Δ
- D3V-116M-1□4-Δ
- D3V-66M-1□4-Δ
- D3V-6G6M-1□3-Δ
- D3V-016M-1□3-Δ

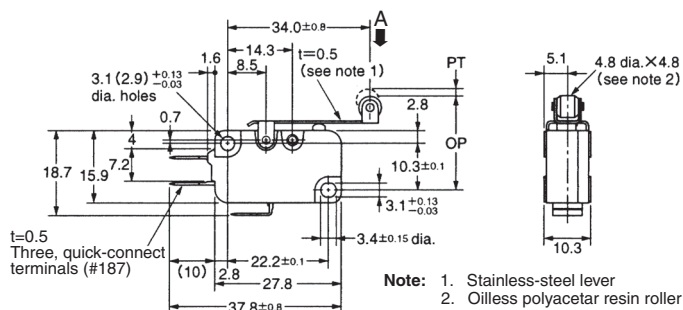

Model	D3V-21G6(M)-1□4A-Δ	D3V-166(M)-1□5-Δ D3V-116(M)-1□5-Δ	D3V-116(M)-1□4-Δ D3V-66(M)-1□4-Δ	D3V-6G6(M)-1□3-Δ	D3V-016(M)-1□3-Δ
OF max. RF min.	80 gf 5 gf	125 gf 14 gf	60 gf 6 gf	30 gf ---	
PT max. OT min. MD max.	4.0 mm 1.6 mm 0.8 mm	4.0 mm 1.6 mm 1.5 mm (F gap type) or 0.8 mm (G gap type)			4.0 mm 1.6 mm 1.5 mm
OP	20.7±1.2 mm				

- D3V-21G6K-1□4A-Δ
- D3V-166K-1□5-Δ
- D3V-116K-1□5-Δ
- D3V-116K-1□4-Δ
- D3V-66K-1□4-Δ
- D3V-6G6K-1□3-Δ
- D3V-016K-1□3-Δ

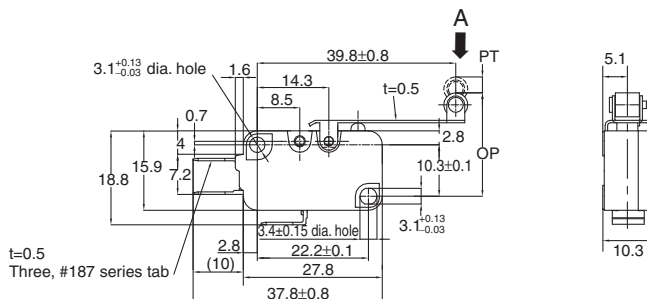

Model	D3V-21G6K-1□4A-D	D3V-166K-1□5-D D3V-116K-1□5-D	D3V-116K-1□4-D D3V-66K-1□4-D	D3V-6G6K-1□3-D	D3V-016K-1□3-D
OF max. RF min.	50 gf 3 gf	75 gf 10 gf	40 gf 3 gf	20 gf ---	
PT max. OT min. MD max.	7.2 mm 2.0 mm 2.0 mm	7.2 mm 2.0 mm 2.7 mm (F gap type) or 2.0 mm (G gap type)			7.2 mm 2.0 mm 2.7 mm
OP	20.7 ± 2.2 mm				

# Precautions

Be sure to read the precautions and information common to all Snap Action and Detection Switches, contained in the Technical User's Guide, "Snap Action Switches, Technical Information" for correct use.

## ■ Correct Use

### Mounting Direction

Mount lever-operated switches with a maximum operating force of 0.49 N in a direction where the actuator weight will not be applied to the switch. Since the switch is designed for a small load, its resetting force is small. Therefore, resetting failure may occur if unnecessary load is applied to the switch.

### Insulation Distance

According to EN61058-1, the minimum insulation thickness for this switch should be 1.1 mm and minimum clearance distance between the terminal and mounting plate should be 1.9 mm. If the insulation distance cannot be provided in the product incorporating the switch, either use a switch with insulation barrier or use a Separator to ensure sufficient insulation distance.

### Using Microloads

Using a model for ordinary loads to switch microloads may result in faulty operation. Instead, use the models that are designed for microloads and that operate in the following range;

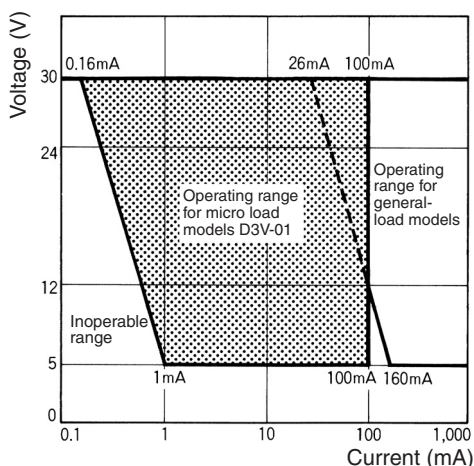

However, even when using microload models within the operating range shown above, if inrush current or inductive voltage spikes occur when the contact is opened or closed, then contact wear may increase and so decrease the service life. Therefore, insert a contact protection circuit where necessary.

## Solder Terminal Approval Conditions

Use of soldering iron for normal soldering is acceptable.
Soldering hook holes version available.
Soldering terminal types 1 and 2 are met.

## ■ Cautions

### Handling

Be careful not to drop the switch. Doing so may cause damage to the switch's internal components because it is designed for a small load.

All sales are subject to Omron Electronic Components LLC standard terms and conditions of sale, which can be found at [http://www.components.omron.com/components/web/webfiles.nsf/sales\\_terms.html](http://www.components.omron.com/components/web/webfiles.nsf/sales_terms.html)

**ALL DIMENSIONS SHOWN ARE IN MILLIMETERS.**  
To convert millimeters into inches, multiply by 0.03937. To convert grams into ounces, multiply by 0.03527.

---

**OMRON**<sup>®</sup>

**OMRON ELECTRONIC  
COMPONENTS LLC**

55 E. Commerce Drive, Suite B  
Schaumburg, IL 60173

**847-882-2288**

**OMRON ON-LINE**

Global - <http://www.omron.com>

USA - <http://www.components.omron.com>





Компания «ЭлектроПласт» предлагает заключение долгосрочных отношений при поставках импортных электронных компонентов на взаимовыгодных условиях!

Наши преимущества:

- Оперативные поставки широкого спектра электронных компонентов отечественного и импортного производства напрямую от производителей и с крупнейших мировых складов;
- Поставка более 17-ти миллионов наименований электронных компонентов;
- Поставка сложных, дефицитных, либо снятых с производства позиций;
- Оперативные сроки поставки под заказ (от 5 рабочих дней);
- Экспресс доставка в любую точку России;
- Техническая поддержка проекта, помощь в подборе аналогов, поставка прототипов;
- Система менеджмента качества сертифицирована по Международному стандарту ISO 9001;
- Лицензия ФСБ на осуществление работ с использованием сведений, составляющих государственную тайну;
- Поставка специализированных компонентов (Xilinx, Altera, Analog Devices, Intersil, Interpoint, Microsemi, Aeroflex, Peregrine, Syfer, Eurofarad, Texas Instrument, Miteq, Cobham, E2V, MA-COM, Hittite, Mini-Circuits, General Dynamics и др.);

Помимо этого, одним из направлений компании «ЭлектроПласт» является направление «Источники питания». Мы предлагаем Вам помощь Конструкторского отдела:

- Подбор оптимального решения, техническое обоснование при выборе компонента;
- Подбор аналогов;
- Консультации по применению компонента;
- Поставка образцов и прототипов;
- Техническая поддержка проекта;
- Защита от снятия компонента с производства.



#### Как с нами связаться

**Телефон:** 8 (812) 309 58 32 (многоканальный)

**Факс:** 8 (812) 320-02-42

**Электронная почта:** [org@eplast1.ru](mailto:org@eplast1.ru)

**Адрес:** 198099, г. Санкт-Петербург, ул. Калинина, дом 2, корпус 4, литера А.