

# General Specifications

## Electrical Capacity (Resistive Load)

<b>Power Level (silver):</b>	5A @ 125/250V AC or 5A @ 30V DC
<b>Logic Level (gold):</b>	0.4VA maximum @ 28V AC/DC maximum (Applicable Range 0.1mA ~ 0.1A @ 20mV ~ 28V)
	Note: Find additional explanation of operating range in Supplement section.

## Other Ratings

<b>Contact Resistance:</b>	50 milliohms maximum for silver; 100 milliohms maximum for gold
<b>Insulation Resistance:</b>	200 megohms minimum @ 500V DC
<b>Dielectric Strength:</b>	1,000V AC minimum between contacts for 1 minute minimum; 1,500V AC minimum between contacts & case for 1 minute minimum
<b>Mechanical Life:</b>	1,000,000 operations minimum for momentary; 200,000 operations minimum for alternate action
<b>Electrical Life:</b>	10,000 operations minimum for silver; 100,000 operations minimum for silver with resistive load of 3A @ 125V AC 200,000 operations minimum for gold
<b>Nominal Operating Force:</b>	Single Pole: 1.9N for Square & 1.9N for Rectangular Double Pole: 2.55N for Square & 3.1N for Rectangular
<b>Contact Timing:</b>	Break before make
<b>Travel:</b>	Pretravel .067" (1.7mm); Overtravel .024" (0.6mm); Total Travel .091" (2.3mm)

## Materials & Finishes

<b>Housing/Bezel:</b>	Glass fiber reinforced polyamide (UL94V-0)
<b>Snap-in Frame:</b>	Stainless steel
<b>Movable Contact:</b>	Phosphor bronze
<b>Movable Contacts:</b>	Silver alloy or copper with gold plating
<b>Stationary Contacts:</b>	Silver alloy or copper with gold plating
<b>Switch Terminals:</b>	Phosphor bronze with silver or gold plating
<b>Lamp Terminals:</b>	Brass with silver plating
<b>Base:</b>	Glass fiber reinforced liquid crystal polymer (UL94V-0)

## Environmental Data

<b>Operating Temperature Range:</b>	-25°C through +50°C (-13°F through +122°F) for Illuminated -20°C through +70°C (-4°F through +158°F) for Nonilluminated
<b>Humidity:</b>	90 ~ 95% humidity for 96 hours @ 40°C (104°F)
<b>Vibration:</b>	10 ~ 55Hz with peak-to-peak amplitude of 1.5mm traversing the frequency range & returning in 1 minute; 3 right angled directions for 2 hours
<b>Shock:</b>	50G (490m/s <sup>2</sup> ) acceleration (tested in 6 right angled directions, with 5 shocks in each direction)

## Installation

<b>Cap Installation Force:</b>	7.55N (1.70 lbf) maximum downward force on cap
<b>Soldering Time &amp; Temp:</b>	Wave Soldering (PC version): See Profile A in Supplement section. Manual Soldering: See Profile A in Supplement section.
<b>Cleaning:</b>	These devices are not process sealed. Hand clean locally using alcohol based solution.

## Standards & Certifications

<b>Flammability Standards:</b>	UL94V-0 housing/bezel & base
<b>UL:</b>	<b>File No. E44145 - Recognized only when ordered with marking on switch.</b> Add "/U" or "/CUL" before dash in part number to order UL recognized switch. UL recognized only when ordered switch body with cap assembled. All single & double pole models recognized at 5A @ 125/250V AC or 0.014A @ 28V DC.
<b>CSA:</b>	<b>File No. 023535_0_000 - Certified only when ordered with marking on switch.</b> Add "/C" before dash in part number to order CSA certified switch. All single & double pole models certified at 5A @ 125/250V AC or 5A @ 30V DC or 0.4VA maximum @ 28V AC/DC maximum.

# Distinctive Characteristics

Bright or super bright LEDs (an integral part of the switch) of red, amber, green, blue, or white, in full face or spot illumination plus square or rectangular models.

Combination of PCB mountability and short body allows use in compact applications.

Small behind panel dimension for snap-in mounting in tight spaces.

Snap-acting contact mechanism provides sensitive actuation with audible feedback; quick-make, quick-break characteristic limits arcing and prolongs electrical life.

Latchdown mechanism, independent of switching mechanism, gives visible and tactile indication of circuit status.

Terminals are epoxy sealed to lock out flux, solvents, and other contaminants.

Momentary and alternate action circuits available in the same space-saving body size.

Matching indicators available.



Actual Size



- Supplement
- Accessories
- Indicators
- Touch
- Tilt
- Tactiles
- Slides
- Rotaries
- Keylocks
- Programmable
- D** Illuminated PB
- Pushbuttons
- Rockers
- Toggles

### TYPICAL SWITCH ORDERING EXAMPLE

**UB 1 5 SK G 03 5C — CC**

Poles	
1	SPDT
2	DPDT

Mounting Types	
PCB Mounting	
SK	Square
RK	Rectangular
* Snap-in Mounting	
KK	Square
NK	Rectangular
NBK	Rectangular with Side Barriers
* Standard with Solder Lug terminals	

Circuits		
5	ON	(ON)
( ) = Momentary		
6	ON	ON
Alternate Action with Latchdown		

Contacts & Ratings	
W	Silver Rated 5A @ 125/250V AC
G	Gold Rated 0.4VA max @ 28V AC/DC max

Terminals	
01	Solder Lug* (for Snap-in Mounting)
03	Straight PC

LEDs	
Bright LED	
5C	Red
5D	Amber
5F	Green
Super Bright LED	
6B	White
6F	Green
6G	Blue
Available with Square only	
Nonilluminated	
N	Nonilluminated

Cap Types & Colors			
Full Face Illuminated Cap for Bright LED			
Lens/Diffuser Colors			
CB	Red/White	FF	Green/Green
CC	Red/Red	*FJ	Green/Clear
*CJ	Red/Clear	JB	Clear/White
DB	Amber/White	JC	Clear/Red
DD	Amber/Amber	JD	Clear/Amber
*DJ	Amber/Clear	JF	Clear/Green
FB	Green/White	*JJ	Clear/Clear
AB	Square & Rectangular Spot Illuminated Black Cap with White Window		
* Not available with Rectangular cap			
Full Face Illuminated Cap for Super Bright LED			
JB	Clear Lens/White Diffuser		
AB	Spot Illuminated Black Cap with White Window		
For Square only; see cap detail page			
Nonilluminated Cap Colors			
A	Black	E	Yellow
B	White	F	Green
C	Red	G	Blue

\* Wire harness & cable assemblies offered only in Americas

**IMPORTANT:**  
Switches are supplied without UL, cULus & CSA marking unless specified. **UL, cULus & CSA recognized only when ordered with marking on the switch.** Specific models, ratings, & ordering instructions are noted on General Specifications page.

### DESCRIPTION FOR TYPICAL ORDERING EXAMPLE

#### UB15SKG035C-CC

Gold Contacts with 0.4VA Rating

Square with PCB Mounting

Red, Bright LED & Red Lens with Red Diffuser

SPDT ON-(ON) Circuit

Straight PC Terminals

Toggles  
Rockers  
Pushbuttons  
Illuminated PB  
Programmable  
Keylocks  
Rotaries  
Slides  
Tactiles  
Tilt  
Touch  
Indicators  
Accessories  
Supplement

POLES & CIRCUITS						
Pole	Model	Plunger Position ( ) = Momentary		Connected Terminals		Throw & Switch/Lamp Schematics
		Normal	Down	Normal	Down	
SP	UB15 *UB16	ON ON	(ON) ON	1-3	1-2	Notes: Switch is marked with NC, NO, COM, L+ & L-. Lamp circuit is isolated and requires an external power source. SPDT
DP	UB25 *UB26	ON ON	(ON) ON	1-3 4-6	1-2 4-5	DPDT

\* When in latched position for the alternate circuit, cap position is .039" (1.0mm) above the housing.

## MOUNTING TYPES & SHAPES

### PCB Mounting

**SK**

Square



Single Pole



Double Pole

**RK**

Rectangular



Single Pole



Double Pole

### Snap-in Mounting (Solder Lug)

**KK**

Square with Built-in Bezel



**NK**

Rectangular with Built-in Bezel



**NBK**

Rectangular with Built-in Side Barriers



Snap-in Mounting with Solder Lug terminals is the standard combination. Panel Thickness: .039 ~ .126" (1.0 ~ 3.2mm)

## CONTACT MATERIALS & RATINGS

**W**

Silver Contacts

Power Level

5A @ 125V AC & 250V AC

**G**

Gold Contacts

Logic Level

0.4VA maximum @ 28V AC/DC maximum

Complete explanation of operating range in Supplement section.

## TERMINALS

**01**

Solder Lug



**03**

Straight PC



Toggles  
Rockers  
Pushbuttons  
Illuminated PB  
Programmable  
Keylocks  
Rotaries  
Slides  
Tactiles  
Tilt  
Touch  
Indicators  
Accessories  
Supplement

## LED COLORS & SPECIFICATIONS

The electrical specifications shown are determined at a basic temperature of 25°C. LED circuit is isolated and requires external power source. Polarity marks are on bottom of switch. If the source voltage exceeds the rated voltage, a ballast resistor is required. Resistor value can be calculated by using the formula in the Supplement section. LED is an integral part of switch and not available separately.

	Color	Bright			Super Bright			Unit
		5C	5D	5F	6B	6F	6G	
Forward Peak Current	$I_{FM}$	30	30	25	30	30	30	mA
Typical Forward Current	$I_F$	20	20	20	20	20	20	mA
Forward Voltage	$V_F$	1.85	2.0	2.1	3.2	3.2	3.2	V
Reverse Peak Voltage	$V_{RM}$	5	5	5	5	5	5	V
Current Reduction Rate Above 25°C	$\Delta I_F$	0.40	0.42	0.46	0.40	0.40	.040	mA/°C
Ambient Temperature Range		-25° ~ +50°C			-25° ~ +50°C			

**N** No Lamp

## CAP TYPES & COLOR COMBINATIONS

### Full Face Illuminated Cap for Bright LED

#### Lens/Diffuser

#### Colors Available for Square Cap:



AT4074 Lens



AT4075 Diffuser



#### Lens/Diffuser

#### Colors Available for Rectangular Cap:



AT4117 Lens



AT4118 Diffuser



Lens & Diffuser Material: Polycarbonate

Lens Finish: Glossy

Diffuser Finish: Textured

### Spot Illuminated Caps for Bright & Super Bright LEDs

#### Cap/Window Colors Available:

**AB** Black Cap with Translucent White Window for LED Display

Material: Polycarbonate Finish: Matte

AT4119 Square for Bright and Super Bright LED



AT4120 Rectangular for Bright LED



#### Lens/Diffuser

#### Colors Available for Square Cap:

**JB** AT4074 Lens & AT4075 Diffuser (Dimensions above)

Lens & Diffuser Material: Polycarbonate

Lens Finish: Glossy

Rectangular lens & diffuser are not available for combining with super bright LED.

Diffuser Finish: Textured

### Opaque Caps for Nonilluminated

#### Cap Colors Available:

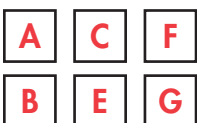

Material: Polycarbonate Finish: Glossy

AT4073 Square

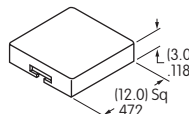

AT4116 Rectangular



Color Codes: A Black B White C Red D Amber E Yellow F Green G Blue J Clear

Toggles  
Rockers  
Pushbuttons  
Illuminated PB  
Programmable  
Keylocks  
Rotaries  
Slides  
Tactiles  
Tilt  
Touch  
Indicators  
Accessories  
Supplement

TYPICAL SWITCH DIMENSIONS

Single & Double Pole

Square • PCB Mount



UB15SKG035C-CB

Single pole models do not have terminals 4, 5, & 6.

Single & Double Pole

Rectangular • PCB Mount



UB26RKG035D-DD

Single pole models do not have terminals 4, 5, & 6.

Single & Double Pole

Square • Snap-in Mount • Built-in Bezel



UB25KKW015C-CB

Single pole models do not have terminals 4, 5, & 6.

Single & Double Pole

Rectangular • Snap-in Mount • Built-in Bezel



UB26NKW015F-FF

Single pole models do not have terminals 4, 5, & 6.

Single & Double Pole

Rectangular • Snap-in Mount • Built-in Side Barriers

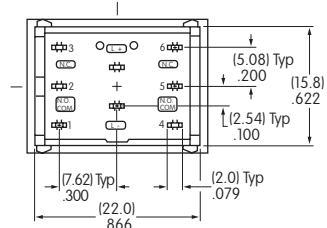

UB25NBKW015F-FB

Single pole models do not have terminals 4, 5, & 6.

## OPTIONAL ACCESSORIES

### Spring Loaded Protective Guard for Snap-in Mounting of Square PCB Model

#### AT4173 Square Protective Guard/ Snap-in Frame

Opens 180°  
Closes automatically

**Materials:**  
Cover: Clear Polycarbonate  
Base: Black Polyamide  
Coil Spring: Stainless Steel

**Recommended  
Panel Thickness:**  
.039" ~ .126"  
(1.0mm ~ 3.2mm)

**Recommended  
Panel-to-PCB Range:**  
.354" ~ .433"  
(9.0mm ~ 11.0mm)

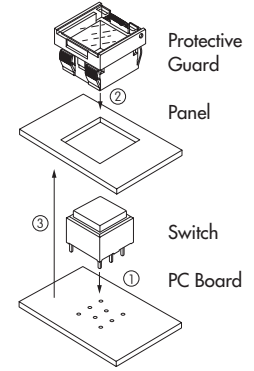
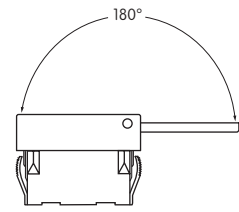
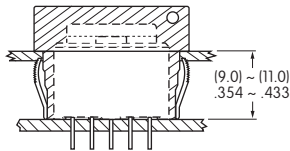
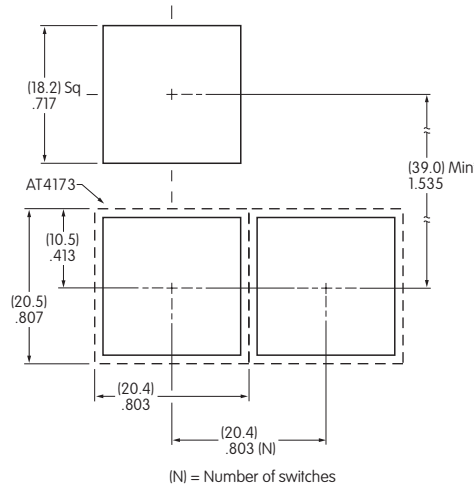
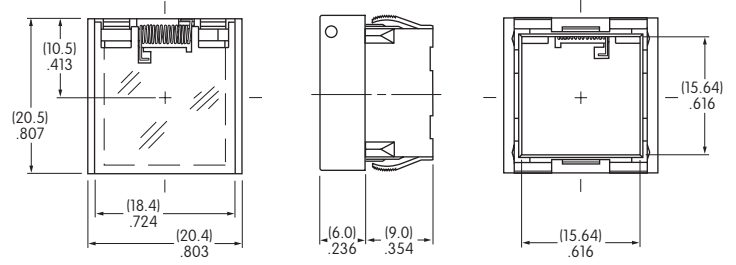

#### Installation

1. Install switch onto PC board.
2. Snap protective guard into panel.
3. Join the two assemblies.

\* Minimum dimension allows opening of cover to 180°

### Spring Loaded Protective Guard for Square Snap-in Model

#### AT4171 Square Protective Guard

Opens 180°  
Closes automatically

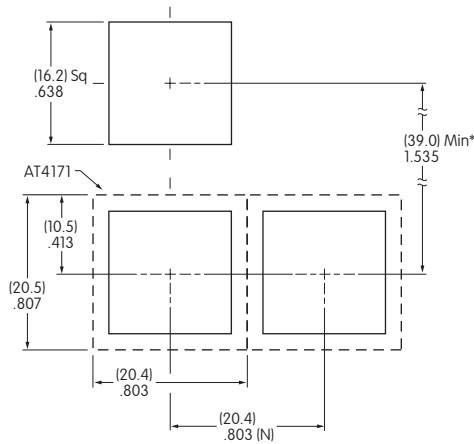
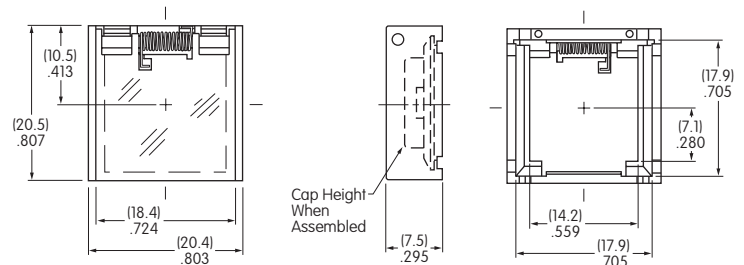

#### Materials:

Cover: Clear Polycarbonate  
Base: Black GFR Polyamide  
Coil Spring: Stainless Steel

**Recommended Panel Thickness:**  
.039" ~ .106" (1.0mm ~ 2.7mm)

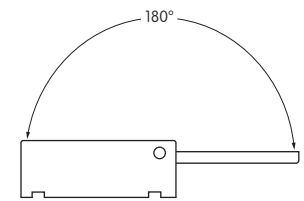

(N) = Number of switches \* Minimum dimension allows opening of cover to 180°

OPTIONAL ACCESSORIES

Spring Loaded Protective Guard for Snap-in Mounting of Rectangular PCB Model

**AT4174**  
Rectangular  
Protective Guard/  
Snap-in Frame

Opens 180°  
Closes automatically

**Materials:**  
Cover: Clear Polycarbonate  
Base: Black Polyamide  
Coil Spring: Stainless Steel

**Recommended Panel Thickness:**  
.039" ~ .126"  
(1.0mm ~ 3.2mm)

**Recommended Panel-to-PCB Range:**  
.354" ~ .433"  
(9.0mm ~ 11.0mm)

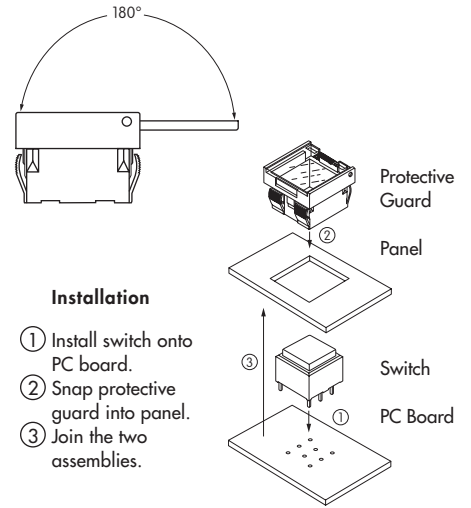
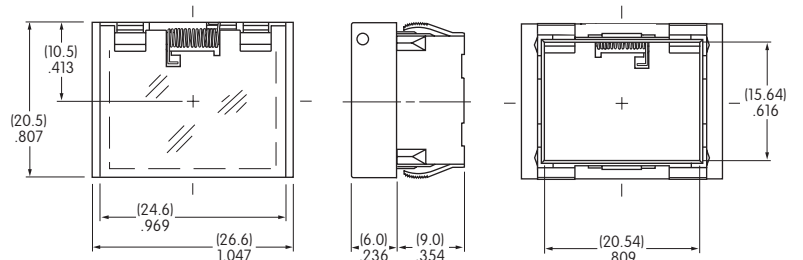
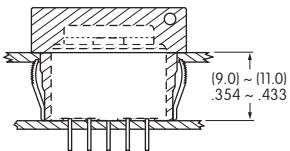

- Installation**
- 1 Install switch on PC board.
  - 2 Snap protective guard into panel.
  - 3 Join the two assemblies.

(N) = Number of switches \* Minimum dimension allows opening of cover to 180°

Spring Loaded Protective Guard for Rectangular Snap-in Model

**AT4172**  
Rectangular  
Protective Guard

Opens 180°  
Closes automatically

**Materials:**  
Cover: Clear Polycarbonate  
Base: Black GFR Polyamide  
Coil Spring: Stainless Steel

**Recommended Panel Thickness:**  
.039" ~ .106" (1.0mm ~ 2.7mm)

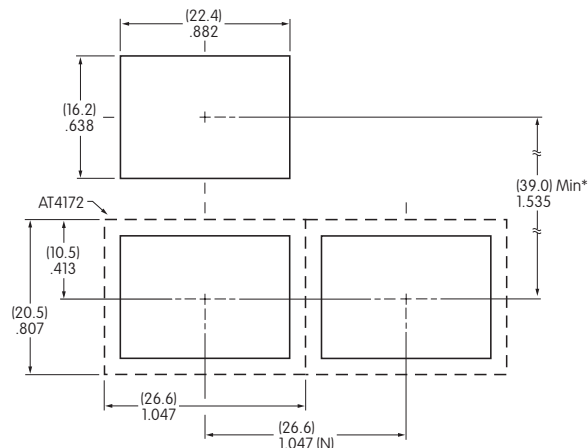
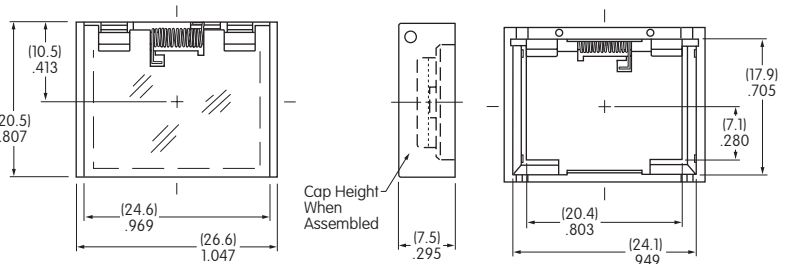
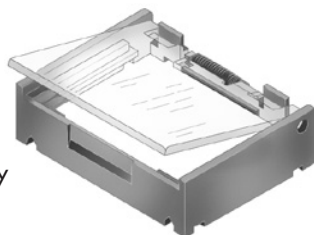

(N) = Number of switches \* Minimum dimension allows opening of cover to 180°

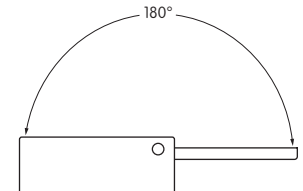

Toggles  
 Rockers  
 Pushbuttons  
**Illuminated PB**  
 Programmable  
 Keylocks  
 Rotaries  
 Slides  
 Tactiles  
 Tilt  
 Touch  
 Indicators  
 Accessories  
 Supplement



Toggles

Rockers

Pushbuttons

Programmable  
**Illuminated PB**

Keylocks

Rotaries

Slides

Tactiles

Tilt

Touch

Indicators

Accessories

Supplement

## OPTIONAL ACCESSORIES

### Dust Covers

**AT4001  
Square**



Only for use with KK mounting type

**AT4011  
Rectangular**



Only for use with NK mounting type



**Materials:**

PVC with polyethylene gasket  
(PVC loses pliability below 0°C (32°F).)

**Recommended Panel Thickness:** .039" ~ .098" (1.0mm ~ 2.5mm)

## LEGENDS

NKK Switches can provide custom legends for caps. Contact factory for more information.

### Suggested Printable Area for UB Lens & Film Insert

**Recommended Methods:** Laser Etch on clear lens, Screen Print or Pad Print on lens;  
Laser Print on film insert.

**Square Cap**



Shaded areas are printable areas.

**Lens**

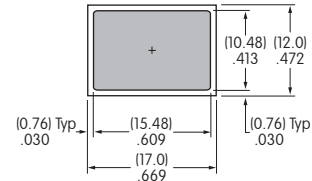
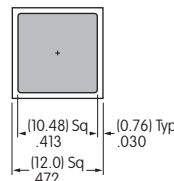

**Rectangular Cap**



**Film Insert**

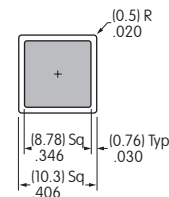

Film Insert: Clear Polyester 4 mil max. thickness





Компания «ЭлектроПласт» предлагает заключение долгосрочных отношений при поставках импортных электронных компонентов на взаимовыгодных условиях!

Наши преимущества:

- Оперативные поставки широкого спектра электронных компонентов отечественного и импортного производства напрямую от производителей и с крупнейших мировых складов;
- Поставка более 17-ти миллионов наименований электронных компонентов;
- Поставка сложных, дефицитных, либо снятых с производства позиций;
- Оперативные сроки поставки под заказ (от 5 рабочих дней);
- Экспресс доставка в любую точку России;
- Техническая поддержка проекта, помощь в подборе аналогов, поставка прототипов;
- Система менеджмента качества сертифицирована по Международному стандарту ISO 9001;
- Лицензия ФСБ на осуществление работ с использованием сведений, составляющих государственную тайну;
- Поставка специализированных компонентов (Xilinx, Altera, Analog Devices, Intersil, Interpoint, Microsemi, Aeroflex, Peregrine, Syfer, Eurofarad, Texas Instrument, Miteq, Cobham, E2V, MA-COM, Hittite, Mini-Circuits, General Dynamics и др.);

Помимо этого, одним из направлений компании «ЭлектроПласт» является направление «Источники питания». Мы предлагаем Вам помощь Конструкторского отдела:

- Подбор оптимального решения, техническое обоснование при выборе компонента;
- Подбор аналогов;
- Консультации по применению компонента;
- Поставка образцов и прототипов;
- Техническая поддержка проекта;
- Защита от снятия компонента с производства.



#### Как с нами связаться

**Телефон:** 8 (812) 309 58 32 (многоканальный)

**Факс:** 8 (812) 320-02-42

**Электронная почта:** [org@eplast1.ru](mailto:org@eplast1.ru)

**Адрес:** 198099, г. Санкт-Петербург, ул. Калинина, дом 2, корпус 4, литера А.