

CATALOG LISTING
2SS52M SERIES CHART 1
PAGE 1 OF 2

ISSUE
M
3

REVISIONS

A	PR23372	J A K	27 MAR 98
B	CO93840	J A F	5 JAN 99

CHECK
J A F 6 APR 98

CHECK
J A F 6 APR 98

CHECK
J A K 27 MAR 98

DDM/CAD
DRAWN
J A K 27 MAR 98

REPLACES
RELEASE NO. PR-23372

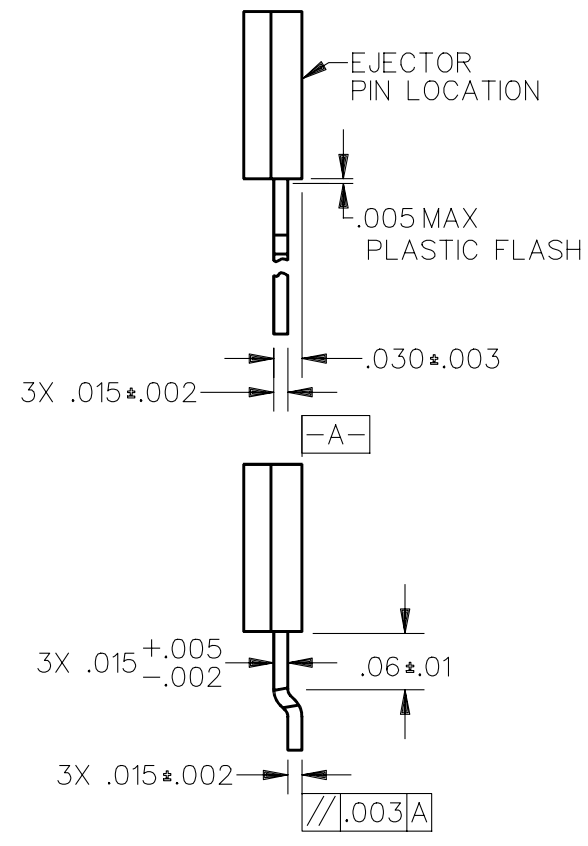
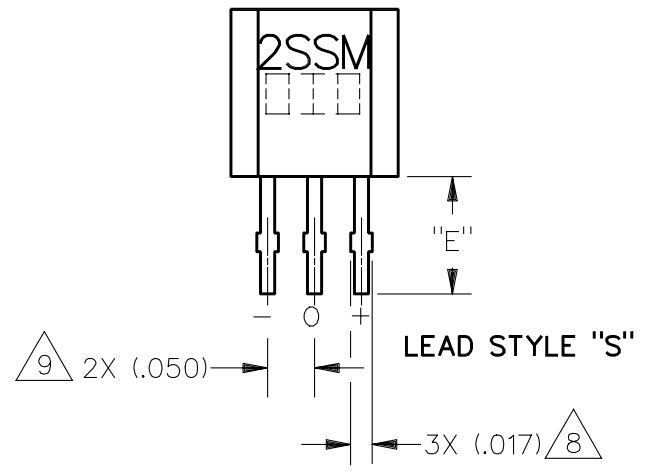
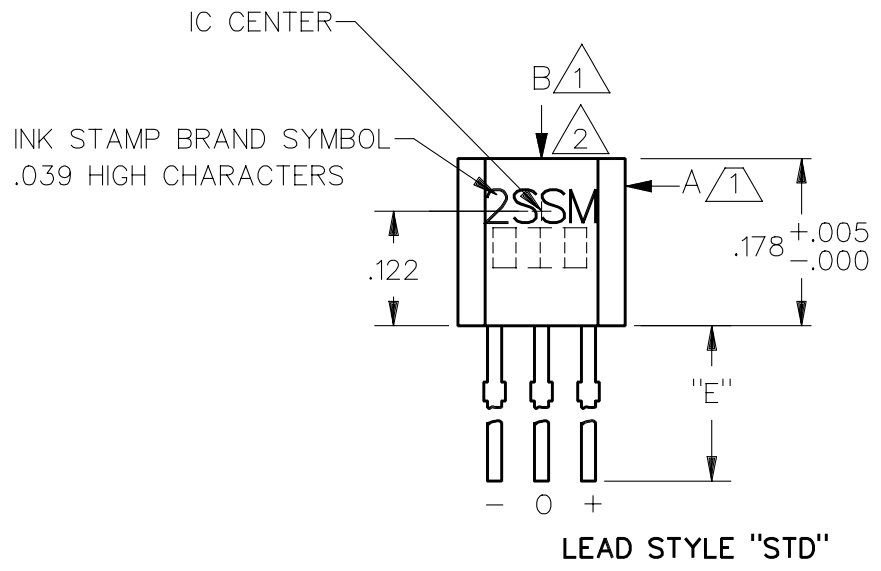
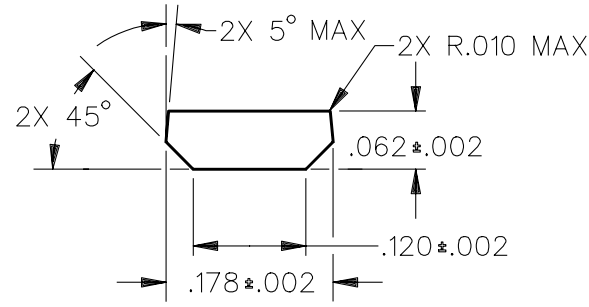

- NOTES
- 1 TO TEST THE SENSOR AGAINST THE SPECIFIED OPERATING CHARACTERISTICS PLACE IN A HELMHOLTZ COIL FIELD AND GIVE THE FOLLOWING HISTORY :
35 GAUSS MINIMUM IN DIRECTION "A" : 35 GAUSS MINIMUM IN DIRECTION "B"
(THIS ASSUMES THE CONVENTION THAT THE DIRECTION OF THE EXTERNAL FLUX OF A MAGNET IS FROM THE NORTH TO SOUTH POLE OF THE MAGNET)
 - 2 THE SENSOR WILL OPERATE WITH THE FLUX FROM EITHER POLE OF A MAGNET WHEN APPLIED IN THE DIRECTION AND LOCATION SHOWN
 - 3 AT SUPPLY VOLTAGE OF 3.8 TO 30 VDC AND OVER THE TEMPERATURE RANGE SPECIFIED
 - 4 AT 24°C ± 2°C, AND 16 VDC ±0.5 % SUPPLY VOLTAGE
 - 5 ABSOLUTE MAXIMUM RATINGS ARE THE EXTREME LIMITS THAT THE DEVICE WILL WITHSTAND WITHOUT DAMAGE TO THE DEVICE. HOWEVER, THE ELECTRICAL AND MAGNETIC CHARACTERISTICS ARE NOT GUARANTEED AS THE MAXIMUM LIMITS (ABOVE RECOMMENDED OPERATING CONDITIONS) ARE APPROACHED NOR WILL THE DEVICE NECESSARILY OPERATE AT ABSOLUTE MAXIMUM RATING
 - 6 THE MAGNETIC CHARACTERISTICS OF THE SENSOR MAY BE AFFECTED BY STRAY MAGNETIC FIELDS
 - 7 AMMOPACK STYLES "T2" & "T3". 24 SENSORS BETWEEN FOLDS, SKIP SPACE AT FOLD. MAY BE REFERRED TO AS "FAN FOLD"
 - 8 MAXIMUM SIZE OVER BURRS. ENTIRE LEAD MUST PASS THROUGH Ø.023 HOLE. LEAD REFERENCE DIMENSIONS DO NOT INCLUDE SOLDER THICKNESS
 - 9 DIMENSION REFERS TO THE LOCATION OF LEAD CENTERLINES AS THEY EXIT THE PLASTIC PACKAGE

THIRD ANGLE PROJECTION

SCALE 5 : 1

DO NOT SCALE PRINT

UNLESS OTHERWISE SPECIFIED TOLERANCES ARE

ONE PLACE	(.0)	±.030
TWO PLACE	(.00)	±.015
THREE PLACE	(.000)	±.005
ANGLES		±

WEIGHT

MICRO SWITCH
a Honeywell Division

FED. MFG. CODE 91929

SOLID STATE SENSOR

CATALOG LISTING
2SS52M SERIES CHART 1

THIS DRAWING COVERS A PROPRIETARY ITEM AND IS THE PROPERTY OF MICRO SWITCH, A DIVISION OF HONEYWELL. THIS DRAWING IS NOT TO BE COPIED OR USED WITHOUT THE APPROVAL OF MICRO SWITCH

MAGNETIC CHARACTERISTICS $\triangle 1 \triangle 3 \triangle 6$

TEMPERATURE RANGE	-20°C TO 85°C	-40°C TO 150°C
OPERATE MAX	25 GAUSS	25 GAUSS
RELEASE MIN	5 GAUSS	4 GAUSS
DIFF MAX	7 GAUSS	8 GAUSS

ABSOLUTE MAXIMUM RATING $\triangle 5$

SUPPLY VOLTAGE (VS)	3.8 TO 30 VOLTS DC
VOLTAGE EXTERNALLY APPLIED TO OUTPUT	+30 VDC MAX WITH SWITCH IN "OFF" CONDITION ONLY -0.5 VOLTS WITH SWITCH IN "OFF" OR "ON" CONDITION
OUTPUT CURRENT	20 mA
TEMPERATURE	-40°C TO 150°C
MAGNETIC FLUX	NO LIMIT, THE CIRCUIT CANNOT BE DAMAGED BY MAGNETIC OVERDRIVE

ELECTRICAL CHARACTERISTICS

	MIN	TYP	MAX	REMARKS
SUPPLY CURRENT (WITHOUT LOAD) $\triangle 4$		6 mA	11 mA 10 mA	MAX (OPERATED) MAX (RELEASED)
OUTPUT VOLTAGE (OPERATED) $\triangle 3$		0.25 V	0.40V	SINKING 20 mA MAX
OUTPUT LEAKAGE CURRENT (RELEASED) $\triangle 3$			10 μ A	LEAKAGE INTO SWITCH OUPUT
OUTPUT SWITCHING TIME $\triangle 3$				1600 OHM, 20 pF LOAD
RISE TIME		0.2 μ S	1.5 μ S	10% TO 90%
FALL TIME		0.1 μ S	1.5 μ S	90% TO 10%

BLOCK DIAGRAM CURRENT SINKING OUTPUT

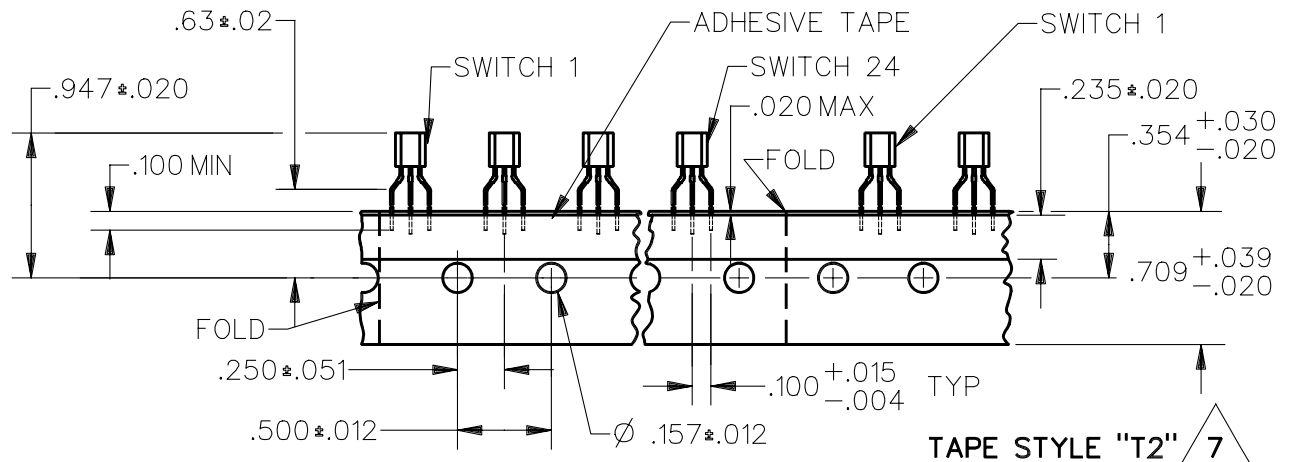
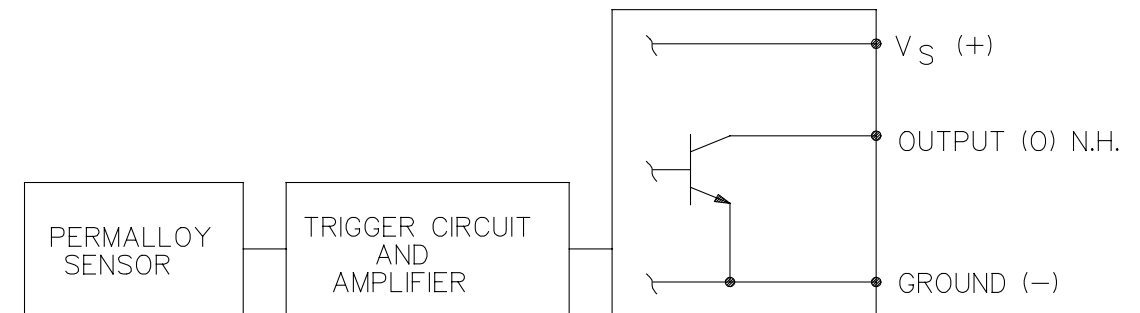

TAPE STYLE "T2" $\triangle 7$

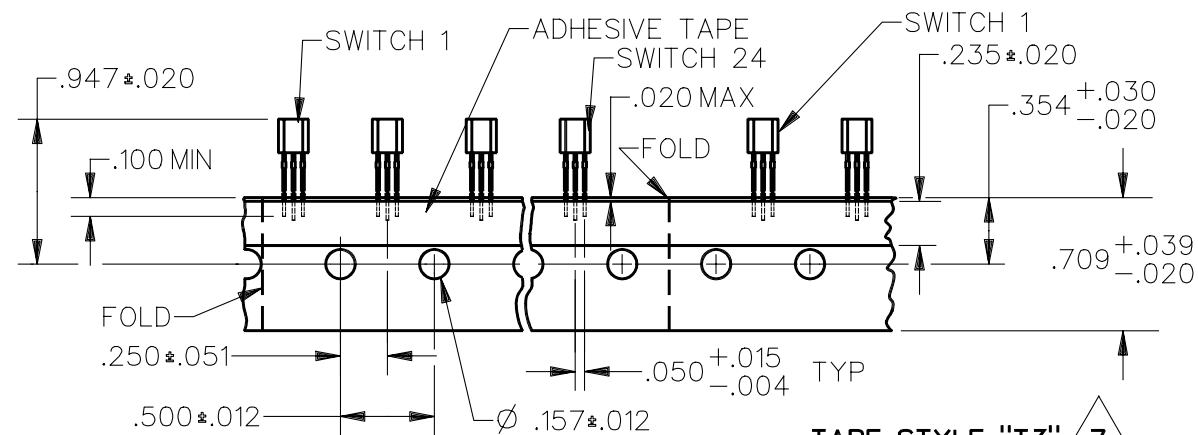

TAPE STYLE "T3" $\triangle 7$

CATALOGING SYSTEM

PREFIX

SUFFIX

BASIC CATALOG LISTING: PACKAGE STYLE, MAGNETIC TYPE, ELECTRICAL/MAGNETIC SPECS
LEAD & PACKAGING OPTIONS: BULK, AMMOPACK

CHARACTERS IN THESE POSITIONS OF THE LISTING ARE BRANDED ON THE PRODUCT

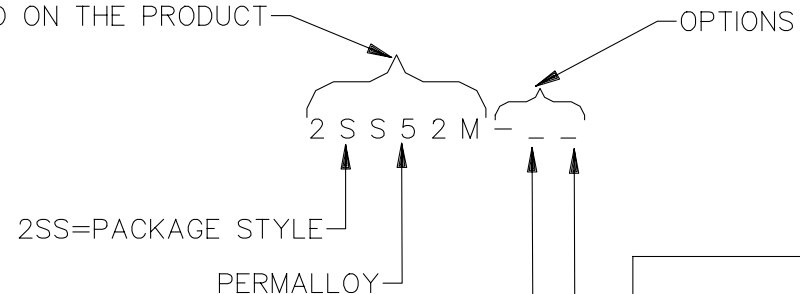

DESCRIPTION	NOMINAL LEAD SPACING	NOMINAL "E" DIM LENGTH	PARTS PER CONTAINER
STANDARD, BULK PACK	.050	.590	1000/BAG
SURFACE MOUNT, BULK PACK	.050	.125	1000/BAG
TAPE, AMMOPACK	.100	.590	5000/BOX
TAPE, AMMOPACK	.050	.590	5000/BOX

S
T 2
T 3

CATALOG LISTING
2SS52M SERIES CHART 1
PAGE 2 OF 2
ISSUE 3

REVISIONS
A PR23372
J A K
27 MAR 98
B CO93840
J A F
5 JAN 99

DDM/CAD
DRAWN
J A K
27 MAR 98
CHECK
J A F
6 APR 98
CHECK
J A F
6 APR 98
CHECK
J A F
6 APR 98
CHECK

ANSI Y14.5M-1982 APPLIES

THIRD ANGLE PROJECTION	
SCALE	NONE
DO NOT SCALE PRINT	
UNLESS OTHERWISE SPECIFIED TOLERANCES ARE	
ONE PLACE (.0)	±.030
TWO PLACE (.00)	±.015
THREE PLACE (.000)	±.005
ANGLES	±
WEIGHT	



Компания «ЭлектроПласт» предлагает заключение долгосрочных отношений при поставках импортных электронных компонентов на взаимовыгодных условиях!

Наши преимущества:

- Оперативные поставки широкого спектра электронных компонентов отечественного и импортного производства напрямую от производителей и с крупнейших мировых складов;
- Поставка более 17-ти миллионов наименований электронных компонентов;
- Поставка сложных, дефицитных, либо снятых с производства позиций;
- Оперативные сроки поставки под заказ (от 5 рабочих дней);
- Экспресс доставка в любую точку России;
- Техническая поддержка проекта, помощь в подборе аналогов, поставка прототипов;
- Система менеджмента качества сертифицирована по Международному стандарту ISO 9001;
- Лицензия ФСБ на осуществление работ с использованием сведений, составляющих государственную тайну;
- Поставка специализированных компонентов (Xilinx, Altera, Analog Devices, Intersil, Interpoint, Microsemi, Aeroflex, Peregrine, Syfer, Eurofarad, Texas Instrument, Miteq, Cobham, E2V, MA-COM, Hittite, Mini-Circuits, General Dynamics и др.);

Помимо этого, одним из направлений компании «ЭлектроПласт» является направление «Источники питания». Мы предлагаем Вам помощь Конструкторского отдела:

- Подбор оптимального решения, техническое обоснование при выборе компонента;
- Подбор аналогов;
- Консультации по применению компонента;
- Поставка образцов и прототипов;
- Техническая поддержка проекта;
- Защита от снятия компонента с производства.



Как с нами связаться

Телефон: 8 (812) 309 58 32 (многоканальный)

Факс: 8 (812) 320-02-42

Электронная почта: org@eplast1.ru

Адрес: 198099, г. Санкт-Петербург, ул. Калинина, дом 2, корпус 4, литера А.