



## SY58608U

### 3.2Gbps Precision, 1:2 LVDS Fanout Buffer with Internal Termination and Fail Safe Input

## General Description

The SY58608U is a 2.5V, high-speed, fully differential 1:2 LVDS fanout buffer optimized to provide two identical output copies with less than 20ps of skew and less than 10ps<sub>pp</sub> total jitter. The SY58608U can process clock signals as fast as 2GHz or data patterns up to 3.2Gbps.

The differential input includes Micrel's unique, 3-pin input termination architecture that interfaces to LVPECL, LVDS or CML differential signals, (AC- or DC-coupled) as small as 100mV (200mV<sub>pp</sub>) without any level-shifting or termination resistor networks in the signal path. For AC-coupled input interface applications, an integrated voltage reference ( $V_{REF-AC}$ ) is provided to bias the  $V_T$  pin. The outputs are 325mV LVDS, with rise/fall times guaranteed to be less than 100ps.

The SY58608U operates from a 2.5V  $\pm 5\%$  supply and is guaranteed over the full industrial temperature range ( $-40^\circ\text{C}$  to  $+85^\circ\text{C}$ ). For applications that require CML or LVPECL outputs, consider Micrel's SY58606U and SY58607U, 1:2 fanout buffers with 400mV and 800mV output swings respectively. The SY58608U is part of Micrel's high-speed, Precision Edge<sup>®</sup> product line.

Data sheets and support documentation can be found on Micrel's web site at: [www.micrel.com](http://www.micrel.com).

## Functional Block Diagram

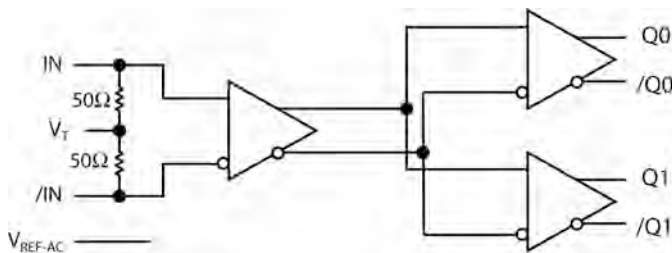

Precision Edge<sup>®</sup>

## Features

- Precision 1:2, 325mV LVDS fanout buffer
- Guaranteed AC performance over temperature and voltage:
  - DC-to > 3.2Gbps throughput
  - <300ps propagation delay (IN-to-Q)
  - <20ps within-device skew
  - <100ps rise/fall times
- Fail Safe Input
  - Prevents outputs from oscillating when input is invalid
- Ultra-low jitter design
  - <1ps<sub>RMS</sub> cycle-to-cycle jitter
  - <10ps<sub>pp</sub> total jitter
  - <1ps<sub>RMS</sub> random jitter
  - <10ps<sub>pp</sub> deterministic jitter
- High-speed LVDS outputs
- 2.5V  $\pm 5\%$  power supply operation
- Industrial temperature range:  $-40^\circ\text{C}$  to  $+85^\circ\text{C}$
- Available in 16-pin (3mm x 3mm) MLF<sup>®</sup> package

## Applications

- All SONET clock and data distribution
- Fibre Channel clock and data distribution
- Gigabit Ethernet clock and data distribution
- Backplane distribution

## Markets

- DataCom
- Telecom
- Storage
- ATE
- Test and Measurement

Precision Edge is a registered trademark of Micrel, Inc.  
MLF and MicroLeadFrame are registered trademarks of Amkor Technology

Micrel Inc. • 2180 Fortune Drive • San Jose, CA 95131 • USA • tel +1 (408) 944-0800 • fax + 1 (408) 474-1000 • <http://www.micrel.com>

## Ordering Information<sup>(1)</sup>

Part Number	Package Type	Operating Range	Package Marking	Lead Finish
SY58608UMG	MLF-16	Industrial	608U with Pb-Free bar-line indicator	NiPdAu Pb-Free
SY58608UMGTR <sup>(2)</sup>	MLF-16	Industrial	608U with Pb-Free bar-line indicator	NiPdAu Pb-Free

**Notes:**

1. Contact factory for die availability. Dice are guaranteed at T<sub>A</sub> = 25°C, DC Electricals only.
2. Tape and Reel.

## Pin Configuration

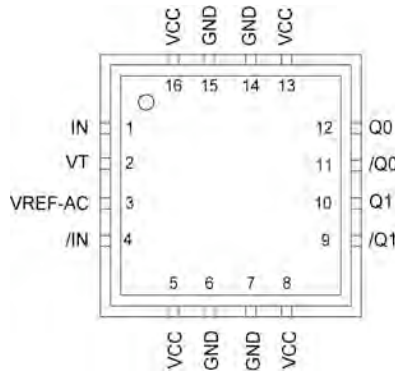

**16-Pin MLF<sup>®</sup> (MLF-16)**

## Pin Description

Pin Number	Pin Name	Pin Function
1, 4	IN, /IN	Differential Inputs: This input pair is the differential signal input to the device. Input accepts DC-coupled differential signals as small as 100mV (200mV <sub>PP</sub> ). Each pin of this pair internally terminates with 50Ω to the VT pin. If the input swing falls below a certain threshold (typical 30mV), the Fail Safe Input (FSI) feature will guarantee a stable output by latching the outputs to its last valid state. See “Input Interface Applications” section for more details.
2	VT	Input Termination Center-Tap: Each input terminates to this pin. The VT pin provides a center-tap for each input (IN, /IN) to a termination network for maximum interface flexibility. See “Input Interface Applications” section.
3	VREF-AC	Reference Voltage: This output bias to V <sub>CC</sub> -1.2V. It is used for AC-coupling inputs IN and /IN. Connect VREF-AC directly to the VT pin. Bypass with 0.01μF low ESR capacitor to V <sub>CC</sub> . Maximum sink/source current is ±1.5mA. See “Input Interface Applications” section for more details.
5, 8, 13, 16	VCC	Positive Power Supply: Bypass with 0.1μF//0.01μF low ESR capacitors as close to the VCC pins as possible.
6, 7, 14, 15	GND, Exposed pad	Ground. Exposed pad must be connected to a ground plane that is the same potential as the ground pin.
9, 10 11, 12	/Q1, Q1 /Q0, Q0	LVDS Differential Output Pairs: Differential buffered output copy of the input signal. The output swing is typically 325mV. Normally terminated 100Ω across the output pairs (Q and /Q). See “LVDS Output Termination” section.

**Absolute Maximum Ratings<sup>(1)</sup>**

Supply Voltage ( $V_{CC}$ )	-0.5V to +4.0V
Input Voltage ( $V_{IN}$ )	-0.5V to $V_{CC} + 0.3V$
LVDS Output Current ( $I_{OUT}$ )	$\pm 10mA$
Input Current	
Source or Sink Current on (IN, /IN)	$\pm 50mA$
Current ( $V_{REF}$ )	
Source or sink current on $V_{REF-AC}$ <sup>(4)</sup>	$\pm 1.5mA$
Maximum Operating Junction Temperature	125°C
Lead Temperature (soldering, 20sec.)	260°C
Storage Temperature ( $T_s$ )	-65°C to +150°C

**Operating Ratings<sup>(2)</sup>**

Supply Voltage ( $V_{IN}$ )	+2.375V to +2.635V
Ambient Temperature ( $T_A$ )	-40°C to +85°C
Package Thermal Resistance <sup>(3)</sup>	
MLF <sup>®</sup>	
Still-air ( $\theta_{JA}$ )	60°C/W
Junction-to-board ( $\psi_{JB}$ )	33°C/W

**DC Electrical Characteristics<sup>(5)</sup>**

$T_A = -40^\circ\text{C}$  to  $+85^\circ\text{C}$ , unless otherwise stated.

Symbol	Parameter	Condition	Min	Typ	Max	Units
$V_{CC}$	Power Supply Voltage Range		2.375	2.5	2.625	V
$I_{CC}$	Power Supply Current	No load, max. $V_{CC}$		55	75	mA
$R_{DIFF\_IN}$	Differential Input Resistance (IN-to-/IN)		90	100	110	$\Omega$
$V_{IH}$	Input HIGH Voltage (IN, /IN)	IN, /IN	1.2		$V_{CC}$	V
$V_{IL}$	Input LOW Voltage (IN, /IN)	IN, /IN	0		$V_{IH}-0.1$	V
$V_{IN}$	Input Voltage Swing (IN, /IN)	see Figure 3a, <b>Note 6</b>	0.1		1.7	V
$V_{DIFF\_IN}$	Differential Input Voltage Swing ( IN - /IN )	see Figure 3b	0.2			V
$V_{IN\_FSI}$	Input Voltage Threshold that Triggers FSI			30	100	mV
$V_{REF-AC}$	Output Reference Voltage		$V_{CC}-1.3$	$V_{CC}-1.2$	$V_{CC}-1.1$	V
IN to $V_T$	Voltage from Input to $V_T$				1.28	V

**Notes:**

1. Permanent device damage may occur if absolute maximum ratings are exceeded. This is a stress rating only and functional operation is not implied at conditions other than those detailed in the operational sections of this data sheet. Exposure to absolute maximum ratings conditions for extended periods may affect device reliability.
2. The data sheet limits are not guaranteed if the device is operated beyond the operating ratings.
3. Package thermal resistance assumes exposed pad is soldered (or equivalent) to the device's most negative potential on the PCB.  $\psi_{JB}$  and  $\theta_{JA}$  values are determined for a 4-layer board in still-air number, unless otherwise stated.
4. Due to the limited drive capability, use for input of the same package only.
5. The circuit is designed to meet the DC specifications shown in the above table after thermal equilibrium has been established.
6.  $V_{IN}$  (max) is specified when  $V_T$  is floating.

## LVDS Outputs DC Electrical Characteristics<sup>(7)</sup>

$V_{CC} = +2.5V \pm 5\%$ ,  $R_L = 100\Omega$  across the output pairs;  $T_A = -40^\circ C$  to  $+85^\circ C$ , unless otherwise stated.

Symbol	Parameter	Condition	Min	Typ	Max	Units
$V_{OUT}$	Output Voltage Swing	See Figure 3a	250	325		mV
$V_{DIFF\_OUT}$	Differential Output Voltage Swing	See Figure 3b	500	650		mV
$V_{OCM}$	Output Common Mode Voltage		1.125	1.20	1.275	V
$\Delta V_{OCM}$	Change in Common Mode Voltage		-50		50	mV

### Notes:

7. The circuit is designed to meet the DC specifications shown in the above table after thermal equilibrium has been established.

## AC Electrical Characteristics<sup>(8)</sup>

$V_{CC} = +2.5V \pm 5\%$ ,  $R_L = 100\Omega$  across the output pairs, Input  $t_r/t_f: \leq 300ps$ ;  $T_A = -40^\circ C$  to  $+85^\circ C$ , unless otherwise stated.

Symbol	Parameter	Condition	Min	Typ	Max	Units
$f_{MAX}$	Maximum Frequency	NRZ Data	3.2	4.25		Gbps
		$V_{OUT} > 200mV$ Clock	2	3		GHz
$t_{PD}$	Propagation Delay IN-to-Q	$V_{IN}: 100mV-200mV$	170	280	420	ps
		$V_{IN}: 200mV-800mV$	130	200	300	ps
$t_{Skew}$	Within Device Skew	Note 9		5	20	ps
	Part-to-Part Skew	Note 10			135	ps
$t_{Jitter}$	Data Random Jitter	Note 11			1	$\mu s_{RMS}$
	Deterministic Jitter	Note 12			10	$\mu s_{PP}$
	Clock Cycle-to-Cycle Jitter	Note 13			1	$\mu s_{RMS}$
	Total Jitter	Note 14			10	$\mu s_{PP}$
$t_r, t_f$	Output Rise/Fall Time (20% to 80%)	At full output swing.	35	60	100	ps
	Duty Cycle	Differential I/O	47		53	%

### Notes:

8. These high-speed parameters are Guaranteed by design and characterization.
9. Within-device skew is measured between two different outputs under identical input transitions.
10. Part-to-part skew is defined for two parts with identical power supply voltages at the same temperature and no skew at the edges at the respective inputs.
11. Random jitter is measured with a K28.7 pattern, measured at  $\leq f_{MAX}$ .
12. Deterministic jitter is measured at 2.5Gbps with both K28.5 and  $2^{23}-1$  PRBS pattern.
13. Cycle-to-cycle jitter definition: the variation period between adjacent cycles over a random sample of adjacent cycle pairs.  $t_{JITTER\_CC} = T_n - T_{n+1}$ , where T is the time between rising edges of the output signal.
14. Total jitter definition: with an ideal clock input frequency of  $\leq f_{MAX}$  (device), no more than one output edge in  $10^{12}$  output edges will deviate by more than the specified peak-to-peak jitter value.

## Functional Description

### Fail-Safe Input (FSI)

The input includes a special fail-safe circuit to sense the amplitude of the input signal and to latch the outputs when there is no input signal present, or when the amplitude of the input signal drops sufficiently below  $100\text{mV}_{\text{PK}}$  ( $200\text{mV}_{\text{PP}}$ ), typically  $30\text{mV}_{\text{PK}}$ . Maximum frequency of SY58608U is limited by the FSI function.

### Input Clock Failure Case

If the input clock fails to a floating, static, or extremely low signal swing such that the differential voltage across the input pair is less than  $100\text{mV}$ , the FSI function will eliminate a metastable condition and latch the outputs to the last valid state. No ringing and no indeterminate state will occur at the output under these conditions. The output recovers to normal operation once the input signal returns to a valid state with a differential voltage  $\geq 100\text{mV}$ .

Note that the FSI function will not prevent duty cycle distortion in case of a slowly deteriorating (but still toggling) input signal. Due to the FSI function, the propagation delay will depend on rise and fall time of the input signal and on its amplitude. Refer to "Typical Characteristics" for detailed information.

## Timing Diagrams

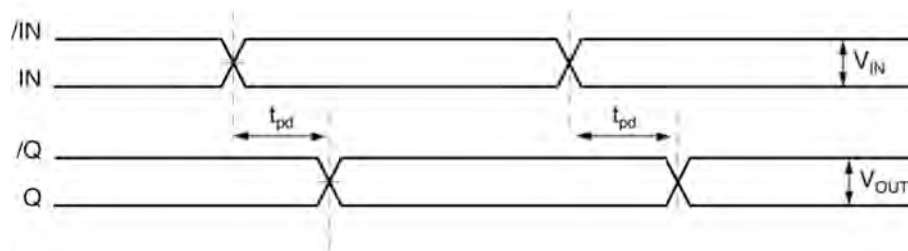

Figure 1a. Propagation Delay

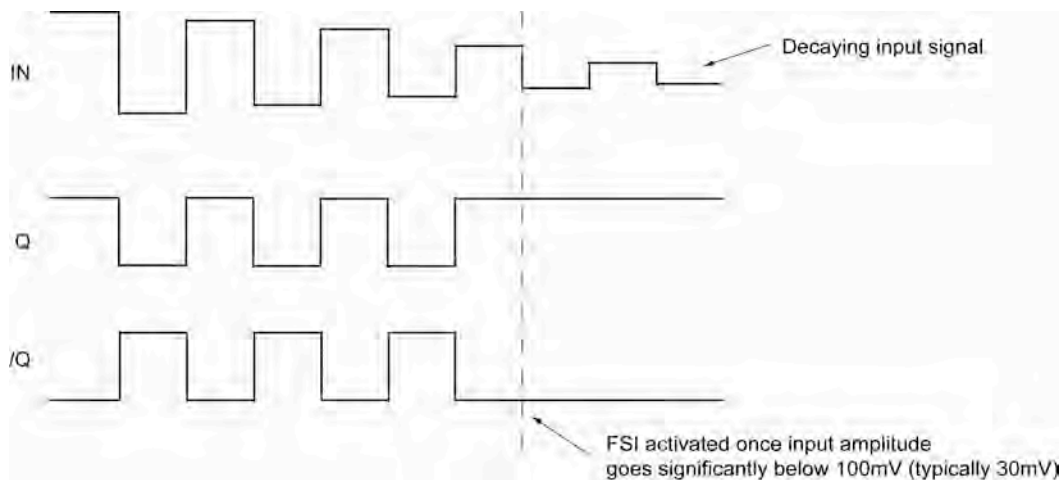
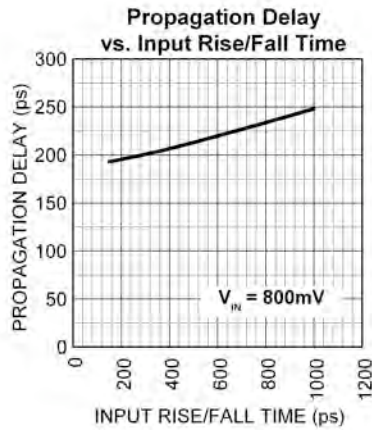
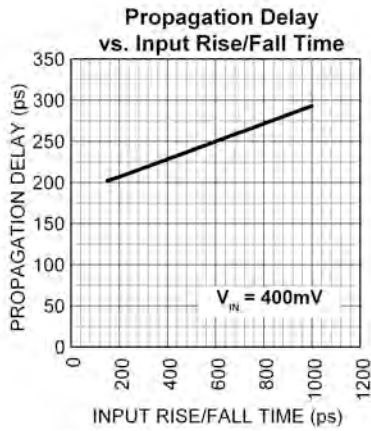
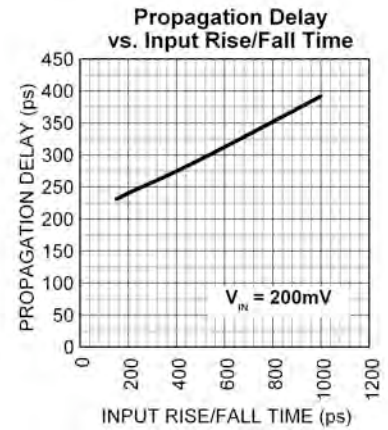
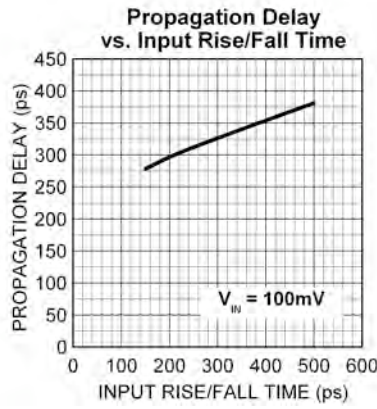
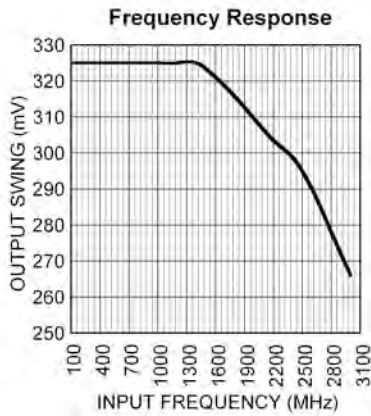

Figure 1b. Fail Safe Feature

## Typical Characteristics

$V_{CC} = 2.5V$ ,  $GND = 0V$ ,  $V_{IN} = 100mV$ ,  $R_L = 100\Omega$  across the output pairs,  $T_A = 25^\circ C$ , unless otherwise stated.



### Functional Characteristics

$V_{CC} = 2.5V$ ,  $GND = 0V$ ,  $V_{IN} = 250mV$ , Data Pattern:  $2^{23}-1$ ,  $R_L = 100\Omega$  across the outputs,  $T_A = 25^\circ C$ , unless otherwise stated.

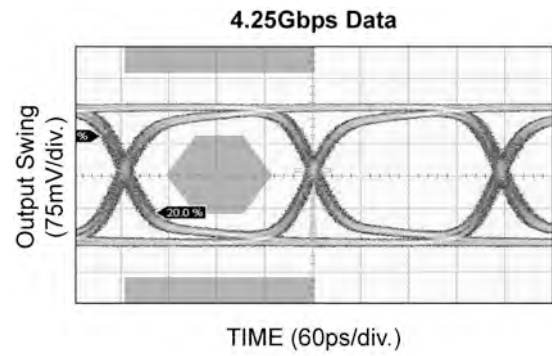
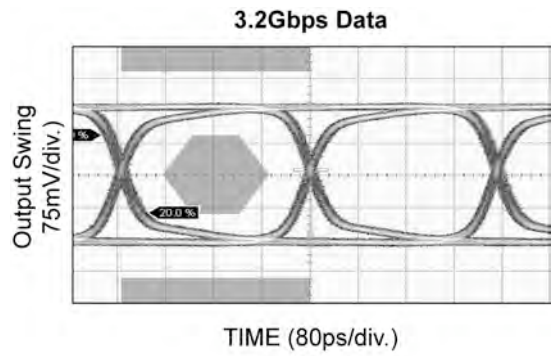
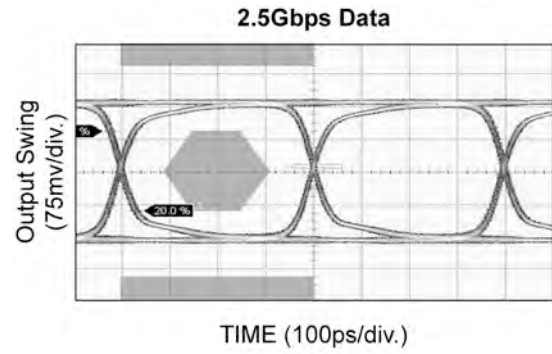
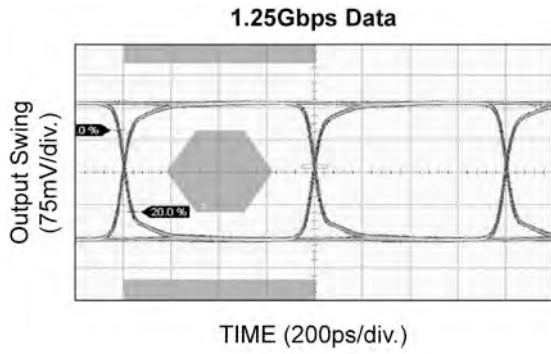



### Functional Characteristics (continued)

$V_{CC} = 2.5V$ ,  $GND = 0V$ ,  $V_{IN} = 250mV$ ,  $R_L = 100\Omega$  across the outputs,  $T_A = 25^\circ C$ , unless otherwise stated.

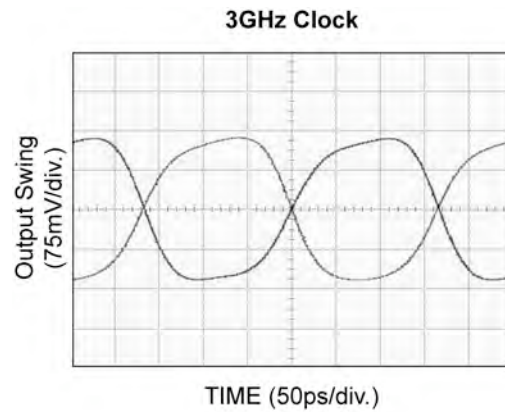
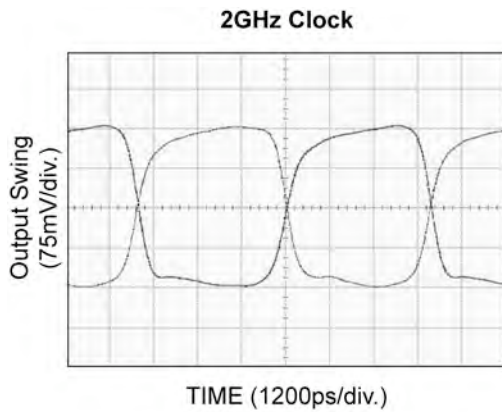
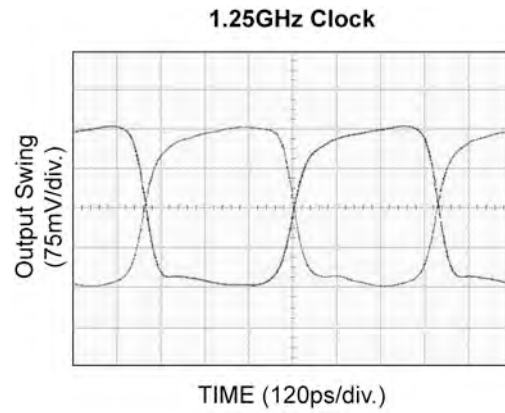
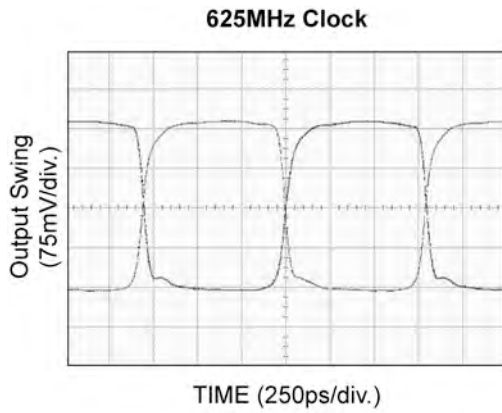

# Input Stage

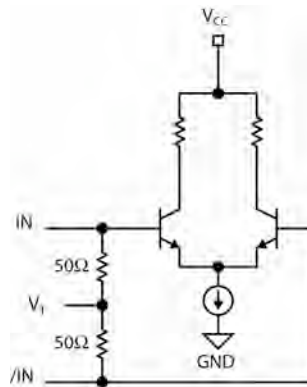

Figure 2. Simplified Differential Input Buffer

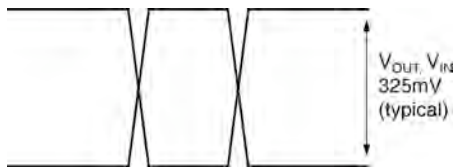

Figure 3a. Single-Ended Swing

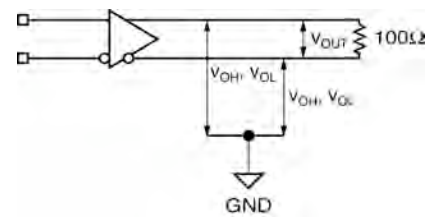

Figure 3c. LVDS Differential Measurement

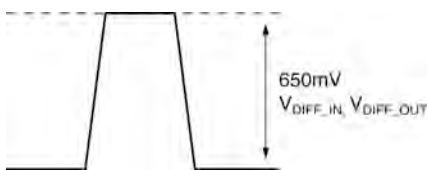

Figure 3b. Differential Swing

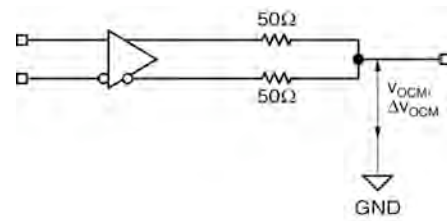

Figure 3d. LVDS Common Mode Measurement

## Input Interface Applications

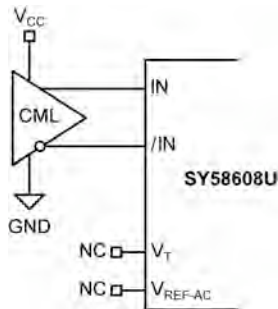

Figure 4a. CML Interface (DC-Coupled)

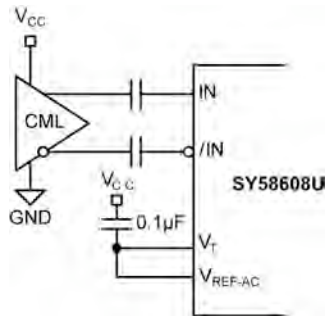

Figure 4b. CML Interface (AC-Coupled)

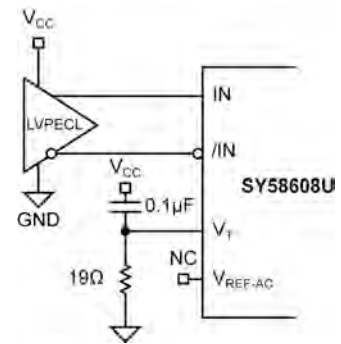

Figure 4c. LVPECL Interface (DC-Coupled)

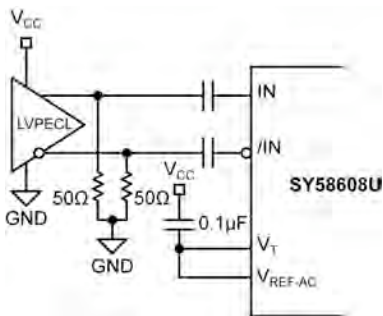

Figure 4d. LVPECL Interface (AC-Coupled)

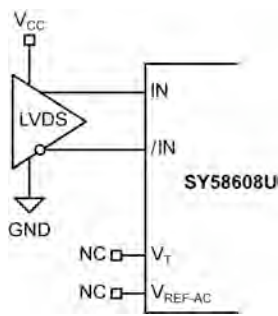
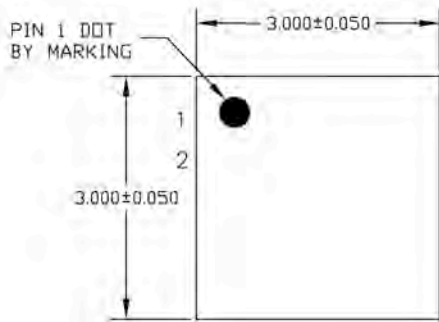

Figure 4e. LVDS Interface (DC-Coupled)

## Related Product and Support Documents

Part Number	Function	Data Sheet Link
SY58606U	4.25Gbps Precision, 1:2 CML Fanout Buffer with Internal Termination and Fail Safe Input	<a href="http://www.micrel.com/page.do?page=/product-info/products/sy58606u.shtml">http://www.micrel.com/page.do?page=/product-info/products/sy58606u.shtml</a>
SY58607U	3.2Gbps Precision, 1:2 LVPECL Fanout Buffer with Internal Termination and Fail Safe Input	<a href="http://www.micrel.com/page.do?page=/product-info/products/sy58607u.shtml">http://www.micrel.com/page.do?page=/product-info/products/sy58607u.shtml</a>
HBW Solutions	New Products and Termination Application Notes	<a href="http://www.micrel.com/product-info/products/sy89830u.shtml">http://www.micrel.com/product-info/products/sy89830u.shtml</a>

### Package Information



TOP VIEW

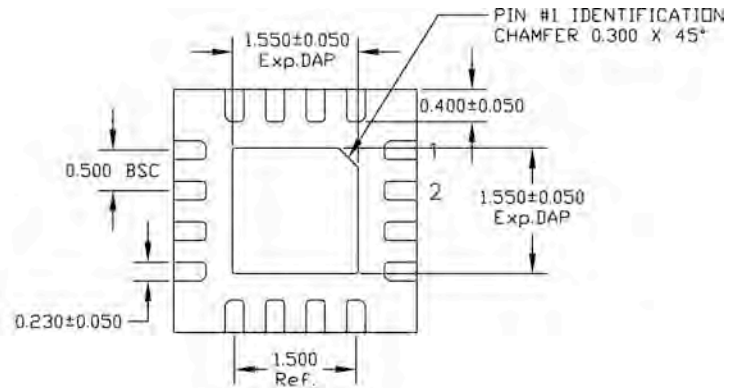

BOTTOM VIEW

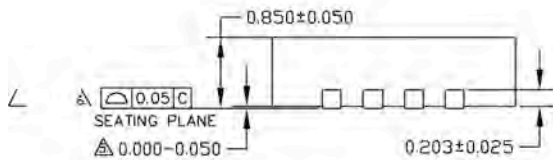

SIDE VIEW

- NOTE
1. ALL DIMENSIONS ARE IN MILLIMETERS.
  2. MAX. PACKAGE WARPAGE IS 0.05 mm.
  3. MAXIMUM ALLOWABLE BURRS IS 0.075 mm IN ALL DIRECTIONS.
  4. PIN #1 ID ON TOP WILL BE LASER/INK MARKED.
- ⚠ APPLIED ONLY FOR TERMINALS.
- ⚠ APPLIED FOR EXPOSED PAD AND TERMINALS.

### 16-Pin (3mm x 3mm) MLF<sup>®</sup> (MLF-16)

**MICREL, INC. 2180 FORTUNE DRIVE SAN JOSE, CA 95131 USA**  
 TEL +1 (408) 944-0800 FAX +1 (408) 474-1000 WEB <http://www.micrel.com>

The information furnished by Micrel in this data sheet is believed to be accurate and reliable. However, no responsibility is assumed by Micrel for its use. Micrel reserves the right to change circuitry and specifications at any time without notification to the customer.

Micrel Products are not designed or authorized for use as components in life support appliances, devices or systems where malfunction of a product can reasonably be expected to result in personal injury. Life support devices or systems are devices or systems that (a) are intended for surgical implant into the body or (b) support or sustain life, and whose failure to perform can be reasonably expected to result in a significant injury to the user. A Purchaser's use or sale of Micrel Products for use in life support appliances, devices or systems is a Purchaser's own risk and Purchaser agrees to fully indemnify Micrel for any damages resulting from such use or sale.

© 2006 Micrel, Incorporated.



Компания «ЭлектроПласт» предлагает заключение долгосрочных отношений при поставках импортных электронных компонентов на взаимовыгодных условиях!

Наши преимущества:

- Оперативные поставки широкого спектра электронных компонентов отечественного и импортного производства напрямую от производителей и с крупнейших мировых складов;
- Поставка более 17-ти миллионов наименований электронных компонентов;
- Поставка сложных, дефицитных, либо снятых с производства позиций;
- Оперативные сроки поставки под заказ (от 5 рабочих дней);
- Экспресс доставка в любую точку России;
- Техническая поддержка проекта, помощь в подборе аналогов, поставка прототипов;
- Система менеджмента качества сертифицирована по Международному стандарту ISO 9001;
- Лицензия ФСБ на осуществление работ с использованием сведений, составляющих государственную тайну;
- Поставка специализированных компонентов (Xilinx, Altera, Analog Devices, Intersil, Interpoint, Microsemi, Aeroflex, Peregrine, Syfer, Eurofarad, Texas Instrument, Miteq, Cobham, E2V, MA-COM, Hittite, Mini-Circuits, General Dynamics и др.);

Помимо этого, одним из направлений компании «ЭлектроПласт» является направление «Источники питания». Мы предлагаем Вам помощь Конструкторского отдела:

- Подбор оптимального решения, техническое обоснование при выборе компонента;
- Подбор аналогов;
- Консультации по применению компонента;
- Поставка образцов и прототипов;
- Техническая поддержка проекта;
- Защита от снятия компонента с производства.



#### Как с нами связаться

**Телефон:** 8 (812) 309 58 32 (многоканальный)

**Факс:** 8 (812) 320-02-42

**Электронная почта:** [org@eplast1.ru](mailto:org@eplast1.ru)

**Адрес:** 198099, г. Санкт-Петербург, ул. Калинина, дом 2, корпус 4, литера А.