

Optocoupler, Phototransistor Output, High Reliability, 5300 V_{RMS}

Features

- Good CTR Linearity Depending on Forward Current
- Isolation Test Voltage, 5300 V_{RMS}
- High Collector-Emitter Voltage, V_{CEO} = 70 V
- Low Saturation Voltage
- Fast Switching Times
- Low CTR Degradation
- Temperature Stable
- Low Coupling Capacitance
- End-Stackable, 0.100" (2.54 mm) Spacing
- High Common-Mode Interference Immunity
- Lead (Pb)-free component
- Component in accordance to RoHS 2002/95/EC and WEEE 2002/96/EC

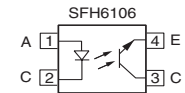
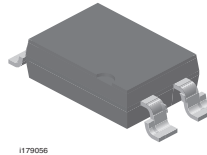
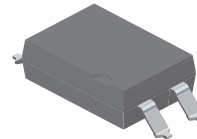
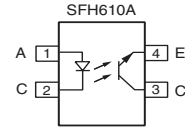
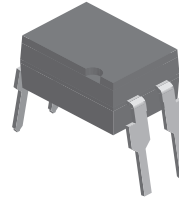

Agency Approvals

- UL1577, File No. E52744 System Code H or J, Double Protection
- DIN EN 60747-5-2 (VDE0884)
DIN EN 60747-5-5 pending
Available with Option 1
- CSA 93751
- BSI IEC60950 IEC60065

Description

The SFH610A (DIP) and SFH6106 (SMD) feature a high current transfer ratio, low coupling capacitance and high isolation voltage. These couplers have a GaAs infrared diode emitter, which is optically coupled to a silicon planar phototransistor detector, and is incorporated in a plastic DIP-4 or SMD package.

The coupling devices are designed for signal transmission between two electrically separated circuits.

The couplers are end-stackable with 2.54 mm spacing.

Creepage and clearance distances of > 8.0 mm are achieved with option 6. This version complies with IEC 60950 (DIN VDE 0805) for reinforced insulation up to an operation voltage of 400 V_{RMS} or DC. Specifications subject to change.

Order Information

| Part | Remarks |
|----------------|---|
| SFH610A-1 | CTR 40 - 80 %, DIP-4 |
| SFH610A-2 | CTR 63 - 125 %, DIP-4 |
| SFH610A-3 | CTR 100 - 200 %, DIP-4 |
| SFH610A-4 | CTR 160 - 320 %, DIP-4 |
| SFH610A-5 | CTR 250 - 500 %, DIP-4 |
| SFH6106-1 | CTR 40 - 80 %, SMD-4 |
| SFH6106-2 | CTR 63 - 125 %, SMD-4 |
| SFH6106-3 | CTR 100 - 200 %, SMD-4 |
| SFH6106-4 | CTR 160 - 320 %, SMD-4 |
| SFH6106-5T | CTR 250 - 500 %, SMD-4, tape and reel |
| SFH610A-1X006 | CTR 40 - 80 %, DIP-4 400 mil |
| SFH610A-1X018T | CTR 40 - 80 %, SMD-4, wide leads spread |
| SFH610A-2X006 | CTR 63 - 125 %, DIP-4 400 mil |
| SFH610A-3X006 | CTR 100 - 200 %, DIP-4 400 mil |
| SFH610A-3X007 | CTR 100 - 200 %, SMD-4 |
| SFH610A-4X006 | CTR 160 - 320 %, DIP-4 400 mil |

For additional information on the available options refer to Option Information.

Absolute Maximum Ratings

$T_{amb} = 25\text{ }^{\circ}\text{C}$, unless otherwise specified

Stresses in excess of the absolute Maximum Ratings can cause permanent damage to the device. Functional operation of the device is not implied at these or any other conditions in excess of those given in the operational sections of this document. Exposure to absolute Maximum Rating for extended periods of the time can adversely affect reliability.

Input

| Parameter | Test condition | Symbol | Value | Unit |
|-----------------------|--------------------------------|------------|-------|------|
| Reverse voltage | | V_R | 6.0 | V |
| DC Forward current | | I_F | 60 | mA |
| Surge forward current | $t \leq 10\text{ }\mu\text{s}$ | I_{FSM} | 2.5 | A |
| Power dissipation | | P_{diss} | 100 | mW |

Output

| Parameter | Test condition | Symbol | Value | Unit |
|---------------------------|------------------------|------------|-------|------|
| Collector-emitter voltage | | V_{CE} | 70 | V |
| Emitter-collector voltage | | V_{EC} | 7.0 | V |
| Collector current | | I_C | 50 | mA |
| | $t \leq 1.0\text{ ms}$ | I_C | 100 | mA |
| Power dissipation | | P_{diss} | 150 | mW |

Coupler

| Parameter | Test condition | Symbol | Value | Unit |
|--|---|-----------|----------------|--------------------|
| Isolation test voltage between emitter and detector, refer to climate DIN 40046, part 2, Nov. 74 | | V_{ISO} | 5300 | V_{RMS} |
| Creepage | | | ≥ 7.0 | mm |
| Clearance | | | ≥ 7.0 | mm |
| Insulation thickness between emitter and detector | | | ≥ 0.4 | mm |
| Comparative Tracking index per DIN IEC 112/VDEO 303, part 1 | | | ≥ 175 | |
| Isolation resistance | $V_{IO} = 500\text{ V}, T_{amb} = 25\text{ }^{\circ}\text{C}$ | R_{IO} | $\geq 10^{12}$ | Ω |
| | $V_{IO} = 500\text{ V}, T_{amb} = 100\text{ }^{\circ}\text{C}$ | R_{IO} | $\geq 10^{11}$ | Ω |
| Storage temperature range | | T_{stg} | - 55 to + 150 | $^{\circ}\text{C}$ |
| Ambient temperature range | | T_{amb} | - 55 to + 100 | $^{\circ}\text{C}$ |
| Junction temperature | | T_j | 100 | $^{\circ}\text{C}$ |
| Soldering temperature | max. 10 s. dip soldering distance to seating plane $\geq 1.5\text{ mm}$ | T_{sld} | 260 | $^{\circ}\text{C}$ |



Electrical Characteristics

$T_{amb} = 25\text{ }^{\circ}\text{C}$, unless otherwise specified

Minimum and maximum values are testing requirements. Typical values are characteristics of the device and are the result of engineering evaluation. Typical values are for information only and are not part of the testing requirements.

Input

| Parameter | Test condition | Symbol | Min | Typ. | Max | Unit |
|--------------------|---|------------|-----|------|------|---------------|
| Forward voltage | $I_F = 60\text{ mA}$ | V_F | | 1.25 | 1.65 | V |
| Reverse current | $V_R = 6.0\text{ V}$ | I_R | | 0.01 | 10 | μA |
| Capacitance | $V_R = 0\text{ V}$, $f = 1.0\text{ MHz}$ | C_O | | 13 | | pF |
| Thermal resistance | | R_{thja} | | 750 | | K/W |

Output

| Parameter | Test condition | Part | Symbol | Min | Typ. | Max | Unit |
|-----------------------------------|--|-------------------------|------------|-----|------|-----|------|
| Collector-emitter capacitance | $V_{CE} = 5\text{ V}$, $f = 1.0\text{ MHz}$ | | C_{CE} | | 5.2 | | pF |
| Thermal resistance | | | R_{thja} | | 500 | | K/W |
| Collector-emitter leakage current | $V_{CE} = 10\text{ V}$ | SFH610A-1 SFH6106-1 | I_{CEO} | | 2.0 | 50 | nA |
| | | SFH610A-2 SFH6106-2 | I_{CEO} | | 2.0 | 50 | nA |
| | | SFH610A-3 SFH6106-3 | I_{CEO} | | 5.0 | 100 | nA |
| | | SFH610A-4 SFH6106-4 | I_{CEO} | | 5.0 | 100 | nA |
| | | SFH610A-5 SFH6106-5T | I_{CEO} | | 5.0 | 100 | nA |

Coupler

| Parameter | Test condition | Symbol | Min | Typ. | Max | Unit |
|--------------------------------------|---|-------------|-----|------|-----|------|
| Collector-emitter saturation voltage | $I_F = 10\text{ mA}$, $f = 1.0\text{ MHz}$ | V_{CEsat} | 0.4 | 0.25 | | V |
| Coupling capacitance | | C_C | | 0.4 | | pF |

Current Transfer Ratio

| Parameter | Test condition | Part | Symbol | Min | Typ. | Max | Unit |
|-----------|--|-------------------------|--------|-----|------|-----|------|
| I_C/I_F | $I_F = 10 \text{ mA}, V_{CE} = 5.0 \text{ V}$ | SFH610A-1 SFH6106-1 | CTR | 40 | | 80 | % |
| | | SFH610A-2 SFH6106-2 | CTR | 63 | | 125 | % |
| | | SFH610A-3 SFH6106-3 | CTR | 100 | | 200 | % |
| | | SFH610A-4 SFH6106-4 | CTR | 160 | | 320 | % |
| | | SFH610A-5 SFH6106-5T | CTR | 250 | | 500 | % |
| | $I_F = 1.0 \text{ mA}, V_{CE} = 5.0 \text{ V}$ | SFH610A-1 SFH6106-1 | CTR | 13 | 30 | | % |
| | | SFH610A-2 SFH6106-2 | CTR | 22 | 45 | | % |
| | | SFH610A-3 SFH6106-3 | CTR | 34 | 70 | | % |
| | | SFH610A-4 SFH6106-4 | CTR | 56 | 90 | | % |

Switching Non-saturated

All values presented are typical values

| Parameter | Current | Rise time | Fall time | Turn-on tim | Turn-off time | Cut-off frequency |
|----------------|---|---------------|---------------|---------------|---------------|--------------------------|
| Test condition | $V_{CC} = 5.0 \text{ V}, R_L = 75 \Omega$ | | | | | $V_{CC} = 5.0 \text{ V}$ |
| Symbol | I_F | t_r | t_f | t_{on} | t_{off} | F_{CO} |
| Unit | mA | μs | μs | μs | μs | kHz |
| | 10 | 2.0 | 2.0 | 3.0 | 2.3 | 250 |

Switching Saturated

All values presented are typical values

| Parameter | Current | Rise time | Fall time | Turn-on time | Turn-off time |
|------------------------|---------|---------------|---------------|---------------|---------------|
| Symbol | I_F | t_r | t_f | t_{on} | t_{off} |
| Unit | mA | μs | μs | μs | μs |
| SFH610A-1 SFH6106-1 | 20 | 2.0 | 11 | 3.0 | 18 |
| SFH610A-2 SFH6106-2 | 10 | 3.0 | 14 | 4.2 | 23 |
| SFH610A-3 SFH6106-3 | 10 | 3.0 | 14 | 4.2 | 23 |
| SFH610A-4 SFH6106-4 | 5.0 | 4.6 | 15 | 6.0 | 25 |

Typical Characteristics

$T_{amb} = 25\text{ }^{\circ}\text{C}$, unless otherwise specified



isfh610a_01

Figure 1. Linear Operation (without Saturation)



isfh610a_04

Figure 4. Output Characteristics (typ.) Collector Current vs. Collector-Emitter Voltage



isfh610a_02

Figure 2. Switching Operation (with Saturation)

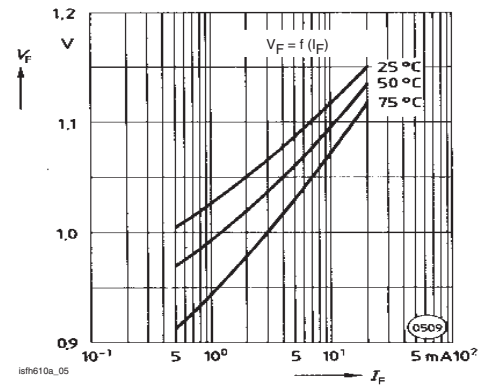

isfh610a_05

Figure 5. Diode Forward Voltage vs. Forward Current

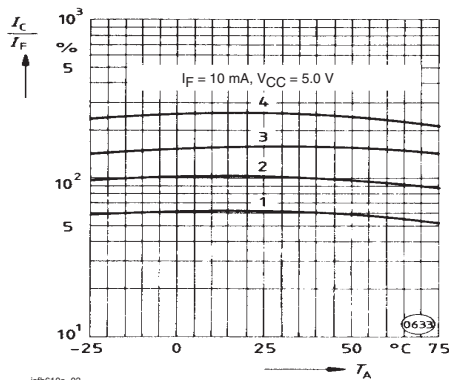

isfh610a_03

Figure 3. Current Transfer Ratio (CTR) vs. Temperature

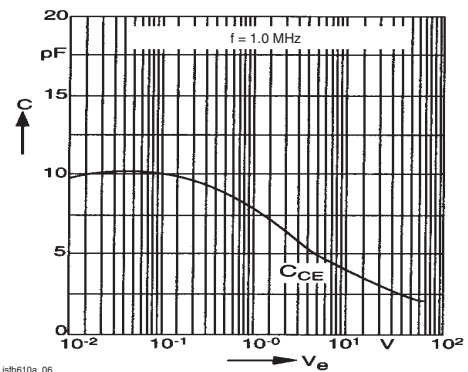

isfh610a_06

Figure 6. Transistor Capacitance (typ.) vs. Collector-Emitter Voltage

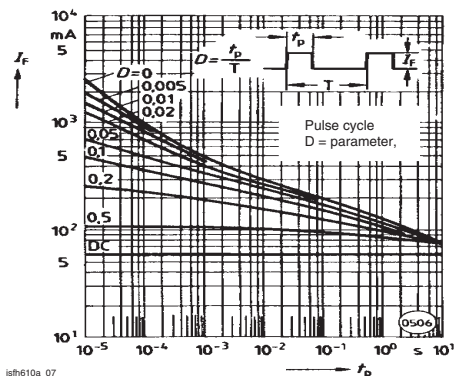

Figure 7. Permissible Pulse Handling Capability Forward Current vs. Pulse Width

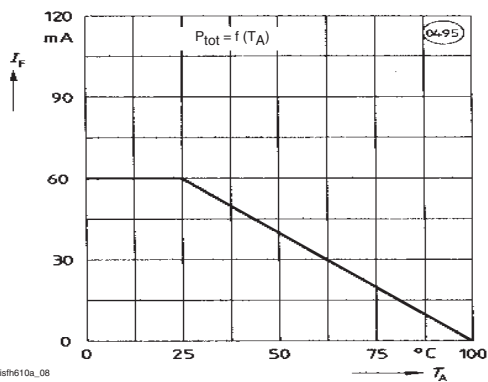

Figure 8. Permissible Power Dissipation vs. Temperature

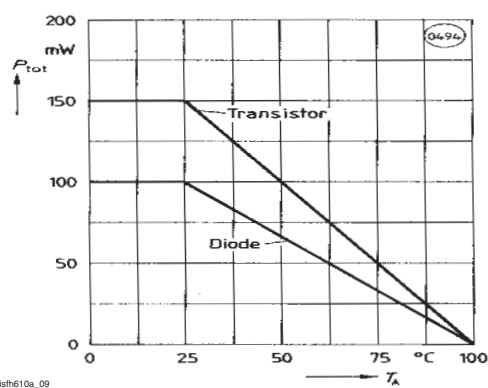
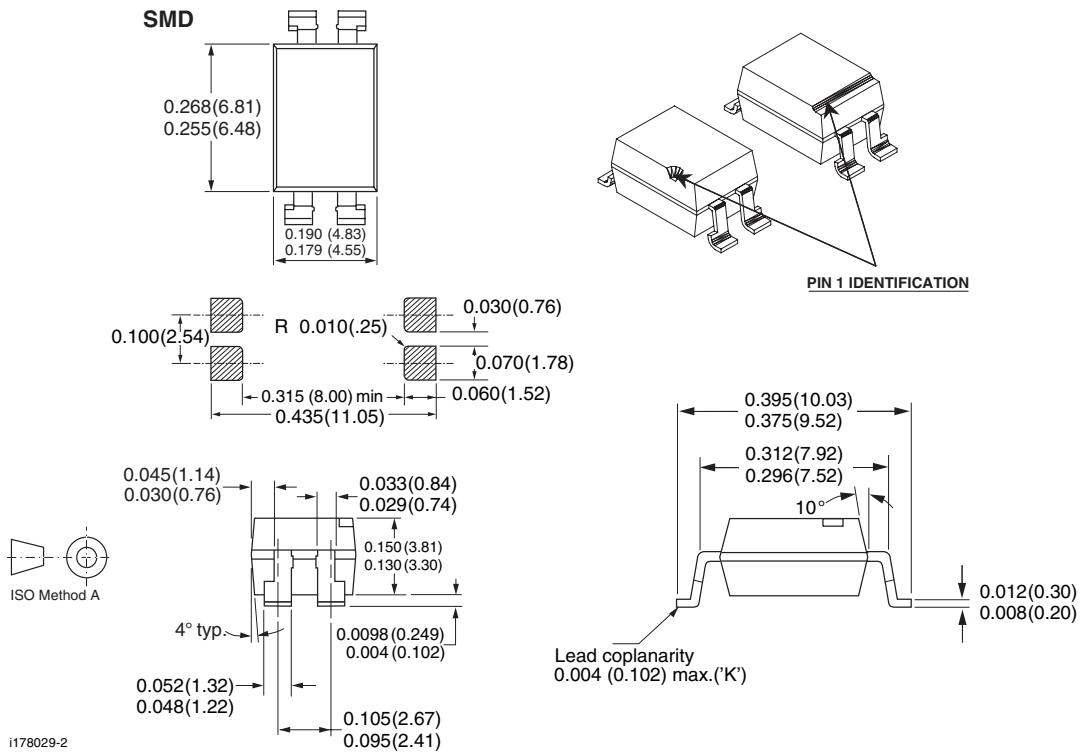

Figure 9. Permissible Diode Forward Current vs. Ambient Temperature

Package Dimensions in Inches (mm)



Package Dimensions in Inches (mm)



SFH610A / SFH6106

Vishay Semiconductors



Option 6

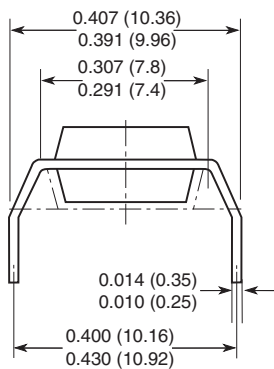

Option 7

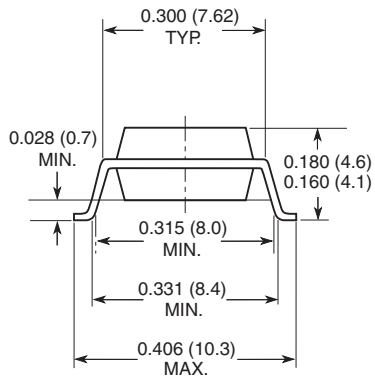

Option 8

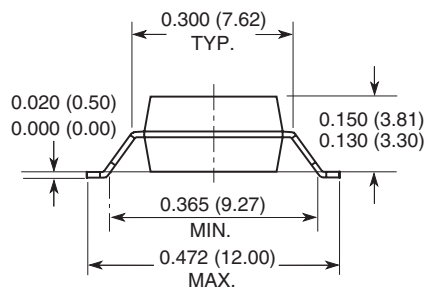

18487



Ozone Depleting Substances Policy Statement

It is the policy of Vishay Semiconductor GmbH to

1. Meet all present and future national and international statutory requirements.
2. Regularly and continuously improve the performance of our products, processes, distribution and operating systems with respect to their impact on the health and safety of our employees and the public, as well as their impact on the environment.

It is particular concern to control or eliminate releases of those substances into the atmosphere which are known as ozone depleting substances (ODSs).

The Montreal Protocol (1987) and its London Amendments (1990) intend to severely restrict the use of ODSs and forbid their use within the next ten years. Various national and international initiatives are pressing for an earlier ban on these substances.

Vishay Semiconductor GmbH has been able to use its policy of continuous improvements to eliminate the use of ODSs listed in the following documents.

1. Annex A, B and list of transitional substances of the Montreal Protocol and the London Amendments respectively
2. Class I and II ozone depleting substances in the Clean Air Act Amendments of 1990 by the Environmental Protection Agency (EPA) in the USA
3. Council Decision 88/540/EEC and 91/690/EEC Annex A, B and C (transitional substances) respectively.

Vishay Semiconductor GmbH can certify that our semiconductors are not manufactured with ozone depleting substances and do not contain such substances.

We reserve the right to make changes to improve technical design and may do so without further notice.

Parameters can vary in different applications. All operating parameters must be validated for each customer application by the customer. Should the buyer use Vishay Semiconductors products for any unintended or unauthorized application, the buyer shall indemnify Vishay Semiconductors against all claims, costs, damages, and expenses, arising out of, directly or indirectly, any claim of personal damage, injury or death associated with such unintended or unauthorized use.

Vishay Semiconductor GmbH, P.O.B. 3535, D-74025 Heilbronn, Germany



Disclaimer

All product specifications and data are subject to change without notice.

Vishay Intertechnology, Inc., its affiliates, agents, and employees, and all persons acting on its or their behalf (collectively, "Vishay"), disclaim any and all liability for any errors, inaccuracies or incompleteness contained herein or in any other disclosure relating to any product.

Vishay disclaims any and all liability arising out of the use or application of any product described herein or of any information provided herein to the maximum extent permitted by law. The product specifications do not expand or otherwise modify Vishay's terms and conditions of purchase, including but not limited to the warranty expressed therein, which apply to these products.

No license, express or implied, by estoppel or otherwise, to any intellectual property rights is granted by this document or by any conduct of Vishay.

The products shown herein are not designed for use in medical, life-saving, or life-sustaining applications unless otherwise expressly indicated. Customers using or selling Vishay products not expressly indicated for use in such applications do so entirely at their own risk and agree to fully indemnify Vishay for any damages arising or resulting from such use or sale. Please contact authorized Vishay personnel to obtain written terms and conditions regarding products designed for such applications.

Product names and markings noted herein may be trademarks of their respective owners.



Компания «ЭлектроПласт» предлагает заключение долгосрочных отношений при поставках импортных электронных компонентов на взаимовыгодных условиях!

Наши преимущества:

- Оперативные поставки широкого спектра электронных компонентов отечественного и импортного производства напрямую от производителей и с крупнейших мировых складов;
- Поставка более 17-ти миллионов наименований электронных компонентов;
- Поставка сложных, дефицитных, либо снятых с производства позиций;
- Оперативные сроки поставки под заказ (от 5 рабочих дней);
- Экспресс доставка в любую точку России;
- Техническая поддержка проекта, помощь в подборе аналогов, поставка прототипов;
- Система менеджмента качества сертифицирована по Международному стандарту ISO 9001;
- Лицензия ФСБ на осуществление работ с использованием сведений, составляющих государственную тайну;
- Поставка специализированных компонентов (Xilinx, Altera, Analog Devices, Intersil, Interpoint, Microsemi, Aeroflex, Peregrine, Syfer, Eurofarad, Texas Instrument, Miteq, Cobham, E2V, MA-COM, Hittite, Mini-Circuits, General Dynamics и др.);

Помимо этого, одним из направлений компании «ЭлектроПласт» является направление «Источники питания». Мы предлагаем Вам помощь Конструкторского отдела:

- Подбор оптимального решения, техническое обоснование при выборе компонента;
- Подбор аналогов;
- Консультации по применению компонента;
- Поставка образцов и прототипов;
- Техническая поддержка проекта;
- Защита от снятия компонента с производства.



Как с нами связаться

Телефон: 8 (812) 309 58 32 (многоканальный)

Факс: 8 (812) 320-02-42

Электронная почта: org@eplast1.ru

Адрес: 198099, г. Санкт-Петербург, ул. Калинина, дом 2, корпус 4, литера А.