

**FEATURES**

**Output power for 1 dB compression (P1dB): 14.5 dBm typical**

**Saturated output power (P<sub>SAT</sub>): 17 dBm typical**

**Gain: 13.5 dB typical**

**Noise figure: 2 dB**

**Output third-order intercept (IP3): 26.5 dBm typical**

**Supply voltage: 5 V at 67 mA**

**50 Ω matched input/output**

**Die size: 2.7 mm × 1.35 mm × 0.05 mm**

**APPLICATIONS**

Test instrumentation

Microwave radios and very small aperture terminals (VSATs)

Military and space

Telecommunications infrastructure

Fiber optics

**GENERAL DESCRIPTION**

The **HMC8400** is a gallium arsenide (GaAs), pseudomorphic high electron mobility transistor (pHEMT), monolithic microwave integrated circuit (MMIC). The **HMC8400** is a wideband low noise amplifier that operates between 2 GHz and 30 GHz. The amplifier provides 13.5 dB of gain, a 2 dB noise figure, 26.5 dBm output IP3, and 14.5 dBm of output power at 1 dB gain compression, requiring 67 mA from a 5 V supply. The **HMC8400** is self biased with only a single positive supply needed to achieve a drain current I<sub>DD</sub> of 67 mA. The **HMC8400** also has a gain control option, V<sub>GG2</sub>. The **HMC8400** amplifier input/outputs are internally matched to 50 Ω and dc blocked, facilitating integration into multichip modules (MCMs). All data is taken with the chip connected via two 0.025 mm (1 mil) wire bonds of minimal length 0.31 mm (12 mils).

**FUNCTIONAL BLOCK DIAGRAM**

Figure 1.

**TABLE OF CONTENTS**

Features .....	1	Interface Schematics .....	6
Applications.....	1	Typical Performance Characteristics .....	7
General Description .....	1	Theory of Operation .....	12
Functional Block Diagram .....	1	Applications Information .....	13
Revision History .....	2	Biasing Procedures .....	13
Specifications.....	3	Mounting and Bonding Techniques for Millimeterwave GaAs MMICs.....	13
2 GHz to 6 GHz Frequency Range.....	3	Typical Application Circuit.....	14
6 GHz to 20 GHz Frequency Range.....	3	Assembly Diagram .....	14
20 GHz to 30 GHz Frequency Range.....	4	Outline Dimensions .....	15
Absolute Maximum Ratings.....	5	Ordering Guide .....	15
ESD Caution.....	5		
Pin Configuration and Function Descriptions.....	6		

**REVISION HISTORY**

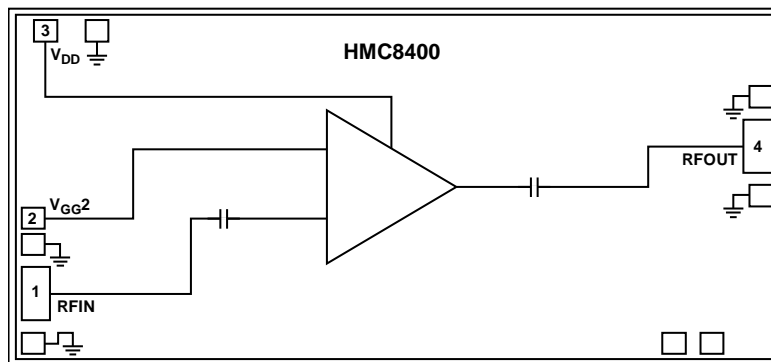
**5/2017—Rev. A to Rev. B**

Changes to Figure 1.....	1
Added Figure 32 and Figure 33; Renumbered Sequentially .....	11

**9/2016—Rev. 0 to Rev. A**

Changes to Features Section.....	1
Updated Outline Dimensions .....	14
Changes to Ordering Guide .....	14

**2/2016—Revision 0: Initial Version**

## SPECIFICATIONS

### 2 GHz TO 6 GHz FREQUENCY RANGE

$T_A = 25^\circ\text{C}$ ,  $V_{DD} = 5\text{ V}$ ,  $I_{DD} = 67\text{ mA}$ ,  $V_{GG2} = \text{open}$ , unless otherwise stated. When using  $V_{GG2}$ , it is recommended to limit  $V_{GG2}$  from  $-2\text{ V}$  to  $+2.6\text{ V}$ .

Table 1.

Parameter	Symbol	Test Conditions/Comments	Min	Typ	Max	Unit
FREQUENCY RANGE			2		6	GHz
GAIN			12	14		dB
Gain Variation Over Temperature				0.005		dB/°C
RETURN LOSS						
Input				13		dB
Output				15		dB
OUTPUT						
Output Power for 1 dB Compression	P1dB		13	16		dBm
Saturated Output Power	$P_{SAT}$			19		dBm
Output Third-Order Intercept	IP3	Measurement taken at $P_{OUT}/\text{tone} = 10\text{ dBm}$		26.5		dBm
NOISE FIGURE	NF			3	5	dB
SUPPLY CURRENT						
Total Supply Current	$I_{DD}$			67		mA
Total Supply Current vs. $V_{DD}$						
$I_{DD} = 64\text{ mA}$				4		V
$I_{DD} = 67\text{ mA}$				5		V
$I_{DD} = 70\text{ mA}$				6		V
SUPPLY VOLTAGE	$V_{DD}$		3	5	7	V

### 6 GHz TO 20 GHz FREQUENCY RANGE

$T_A = 25^\circ\text{C}$ ,  $V_{DD} = 5\text{ V}$ ,  $I_{DD} = 67\text{ mA}$ ,  $V_{GG2} = \text{open}$ , unless otherwise stated. When using  $V_{GG2}$ , it is recommended to limit  $V_{GG2}$  from  $-2\text{ V}$  to  $+2.6\text{ V}$ .

Table 2.

Parameter	Symbol	Test Conditions/Comments	Min	Typ	Max	Unit
FREQUENCY RANGE			6		20	GHz
GAIN			11.5	13.5		dB
Gain Variation Over Temperature				0.006		dB/°C
RETURN LOSS						
Input				18		dB
Output				15		dB
OUTPUT						
Output Power for 1 dB Compression	P1dB		12.5	14.5		dBm
Saturated Output Power	$P_{SAT}$			17		dBm
Output Third-Order Intercept	IP3	Measurement taken at $P_{OUT}/\text{tone} = 10\text{ dBm}$		25		dBm
NOISE FIGURE	NF			2	3.5	dB
SUPPLY CURRENT						
Total Supply Current	$I_{DD}$			67		mA
Total Supply Current vs. $V_{DD}$						
$I_{DD} = 64\text{ mA}$				4		V
$I_{DD} = 67\text{ mA}$				5		V
$I_{DD} = 70\text{ mA}$				6		V
SUPPLY VOLTAGE	$V_{DD}$		3	5	7	V

**20 GHz TO 30 GHz FREQUENCY RANGE**

$T_A = 25^\circ\text{C}$ ,  $V_{DD} = 5\text{ V}$ ,  $I_{DD} = 67\text{ mA}$ ,  $V_{GG2} = \text{open}$ , unless otherwise stated. When using  $V_{GG2}$ , it is recommended to limit  $V_{GG2}$  from  $-2\text{ V}$  to  $+2.6\text{ V}$ .

**Table 3.**

Parameter	Symbol	Test Conditions/Comments	Min	Typ	Max	Unit
FREQUENCY RANGE			20		30	GHz
GAIN			11.5	13.5		dB
Gain Variation Over Temperature				0.008		dB/°C
RETURN LOSS						
Input				15		dB
Output				13		dB
OUTPUT						
Output Power for 1 dB Compression	P1dB		10.5	13.5		dBm
Saturated Output Power	$P_{SAT}$			15.5		dBm
Output Third-Order Intercept	IP3	Measurement taken at $P_{OUT}/\text{tone} = 10\text{ dBm}$		24		dBm
NOISE FIGURE	NF			2.5	4.5	dB
SUPPLY CURRENT						
Total Supply Current	$I_{DD}$			67		mA
Total Supply Current vs. $V_{DD}$						
$I_{DD} = 64\text{ mA}$				4		V
$I_{DD} = 67\text{ mA}$				5		V
$I_{DD} = 70\text{ mA}$				6		V
SUPPLY VOLTAGE	$V_{DD}$		3	5	7	V

## ABSOLUTE MAXIMUM RATINGS

Table 4.

Parameter	Rating
Drain Bias Voltage ( $V_{DD}$ )	8 V
Second Gate Bias Voltage ( $V_{GG2}$ )	-2.5 V to +3 V
RF Input Power (RFIN)	23 dBm
Channel Temperature	175°C
Continuous Power Dissipation ( $P_{DISS}$ ), $T_A = 85^\circ\text{C}$ (Derate 17.2 mW/°C Above 85°C)	1.55 W
Thermal Resistance, $\theta_{JA}$ (Channel to Bottom Die)	58°C/W
Storage Temperature Range	-65°C to +150°C
Operating Temperature Range	-55°C to +85°C
ESD Sensitivity, Human Body Model (HBM)	250 V (Class 1A)

Stresses at or above those listed under Absolute Maximum Ratings may cause permanent damage to the product. This is a stress rating only; functional operation of the product at these or any other conditions above those indicated in the operational section of this specification is not implied. Operation beyond the maximum operating conditions for extended periods may affect product reliability.

### ESD CAUTION



**ESD (electrostatic discharge) sensitive device.** Charged devices and circuit boards can discharge without detection. Although this product features patented or proprietary protection circuitry, damage may occur on devices subjected to high energy ESD. Therefore, proper ESD precautions should be taken to avoid performance degradation or loss of functionality.

### PIN CONFIGURATION AND FUNCTION DESCRIPTIONS

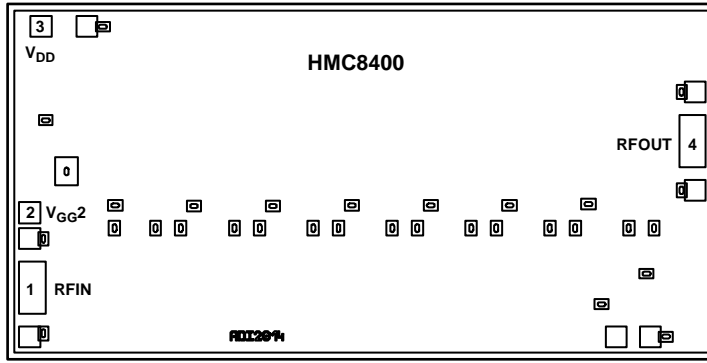

NOTES  
 1. DIE BOTTOM MUST BE CONNECTED TO RF/DC GROUND.

Figure 2. Pad Configuration

Table 5. Pad Function Descriptions

Pad No.	Mnemonic	Description
1	RFIN	Radio Frequency (RF) Input. This pad is ac-coupled, but has a large resistor to GND for ESD protection, and matched to 50Ω. See Figure 3 for the interface schematic.
2	V <sub>GG2</sub>	Gain Control. This pad is dc-coupled and accomplishes gain control by bringing this voltage lower and becoming more negative. See Figure 4 for the interface schematic.
3	V <sub>DD</sub>	Power Supply Voltage for the Amplifier. Connect a dc bias to provide drain current (I <sub>DD</sub> ). See Figure 5 for the interface schematic.
4	RFOUT	RF Output. This pad is ac-coupled, but has a large resistor to GND for ESD protection, and matched to 50Ω. See Figure 6 for the interface schematic.
Die Bottom	GND	Die bottom must be connected to RF/dc ground. See Figure 7 for the interface schematic.

### INTERFACE SCHEMATICS

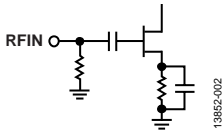

Figure 3. RFIN Interface Schematic

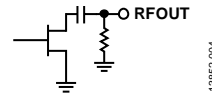

Figure 6. RFOUT Interface Schematic

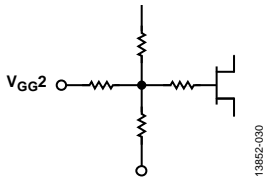

Figure 4. V<sub>GG2</sub> Interface Schematic

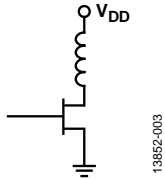

Figure 5. V<sub>DD</sub> Interface Schematic



Figure 7. GND Interface Schematic

### TYPICAL PERFORMANCE CHARACTERISTICS

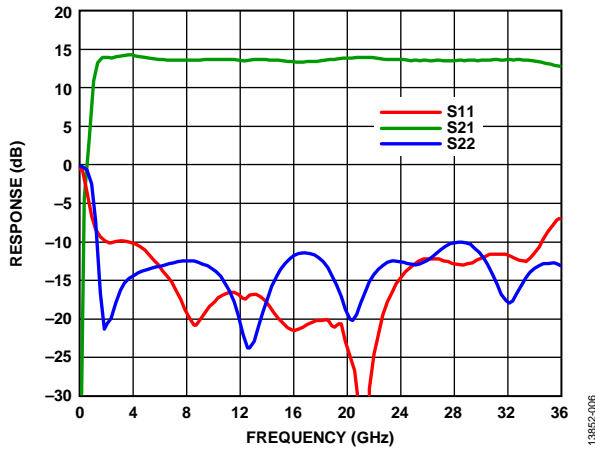

Figure 8. Response Gain and Return Loss vs. Frequency

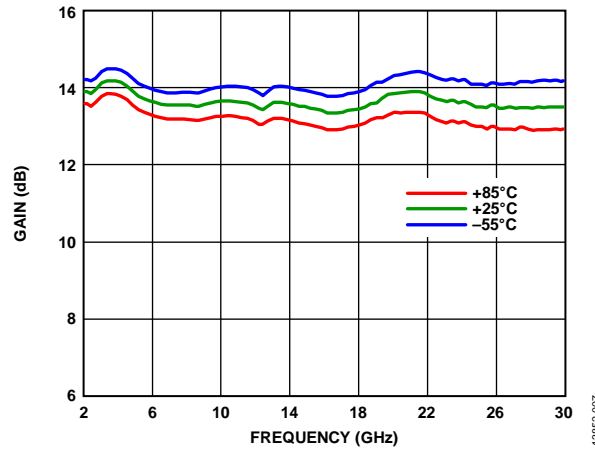

Figure 11. Gain vs. Frequency at Various Temperatures

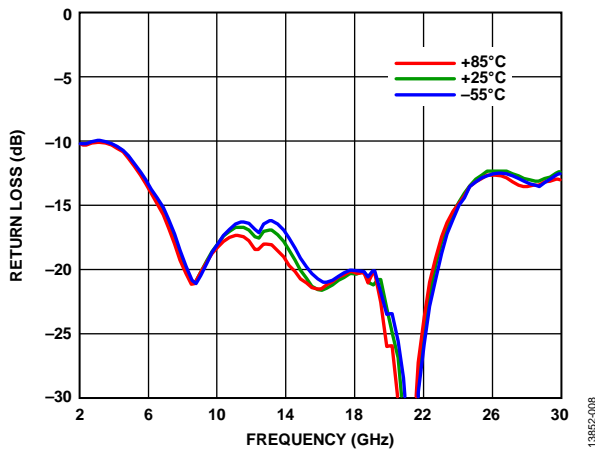

Figure 9. Input Return Loss vs. Frequency at Various Temperatures

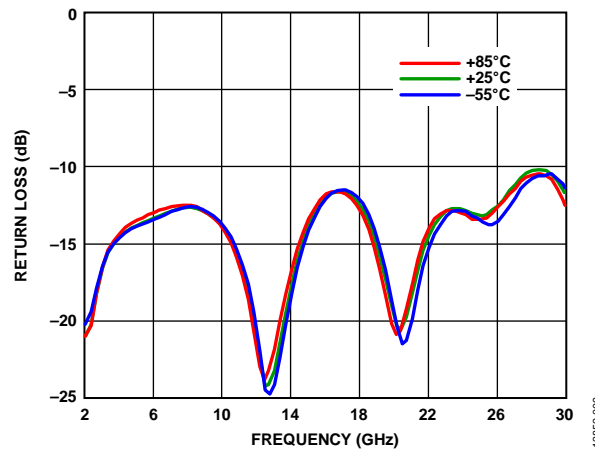

Figure 12. Output Return Loss vs. Frequency at Various Temperatures

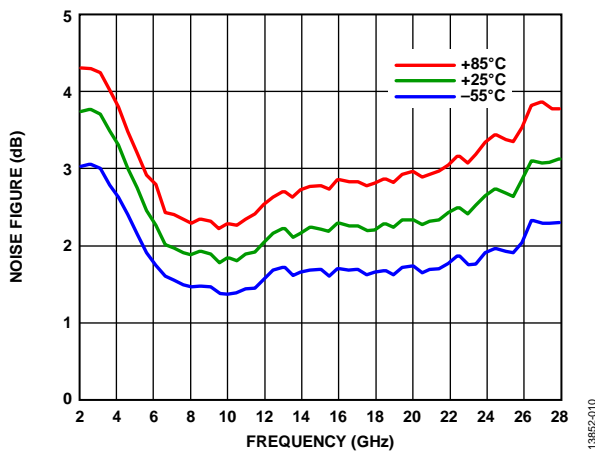

Figure 10. Noise Figure vs. Frequency at Various Temperatures

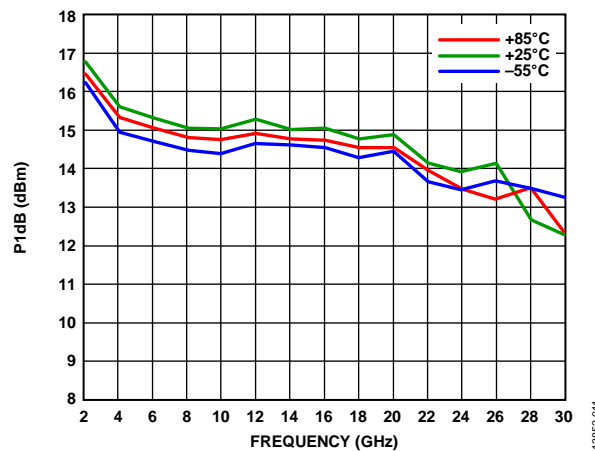

Figure 13. P1dB vs. Frequency at Various Temperatures

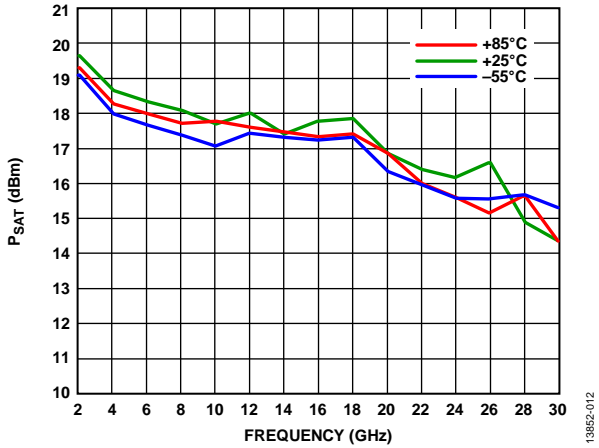

Figure 14.  $P_{SAT}$  vs. Frequency at Various Temperatures

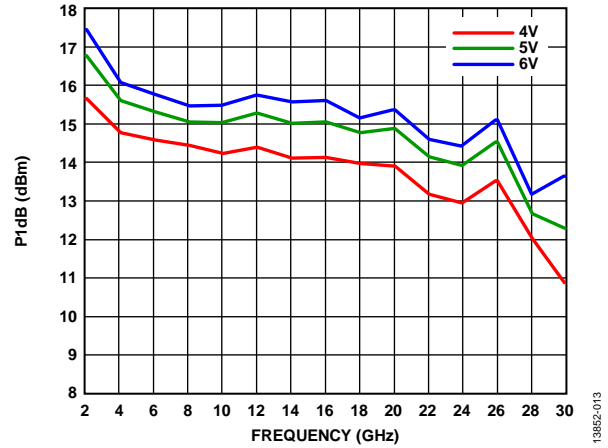

Figure 17.  $P_{1dB}$  vs. Frequency at Various Supply Voltages

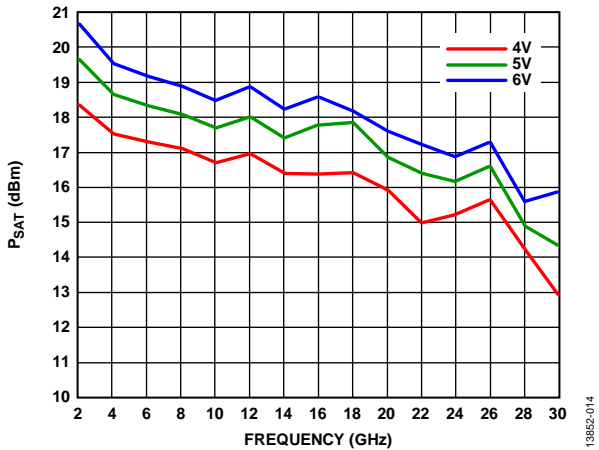

Figure 15.  $P_{SAT}$  vs. Frequency at Various Supply Voltages

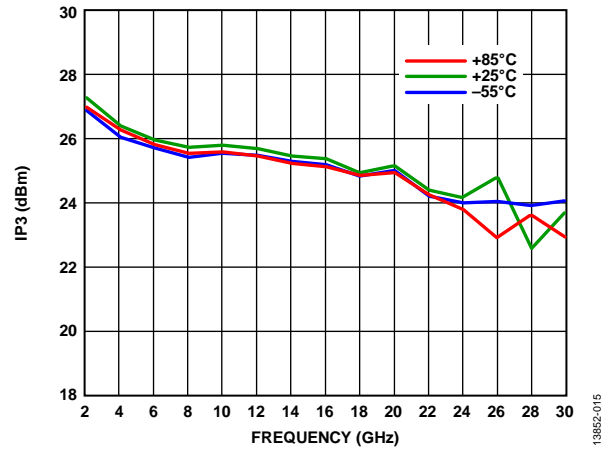

Figure 18. Output  $IP_3$  vs. Frequency for Various Temperatures at  $P_{OUT} = 0$  dBm/Tone

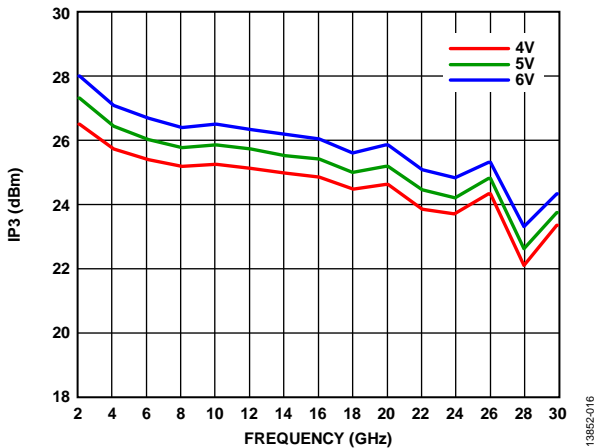

Figure 16. Output  $IP_3$  vs. Frequency at Various Supply Voltages

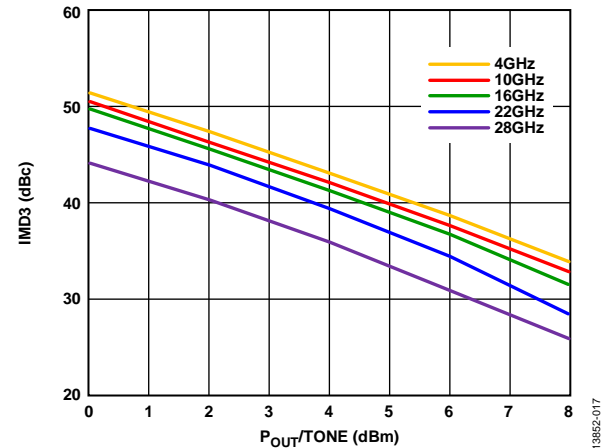

Figure 19. Output Third-Order Intermodulation ( $IMD_3$ ) vs.  $P_{OUT}/Tone$  for Various Frequencies at  $V_{DD} = 4$  V



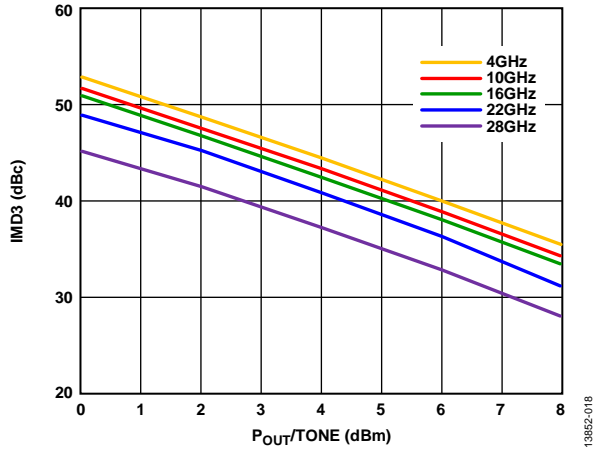

Figure 20. IMD3 vs.  $P_{out}/Tone$  for Various Frequencies at  $V_{DD} = 5 V$

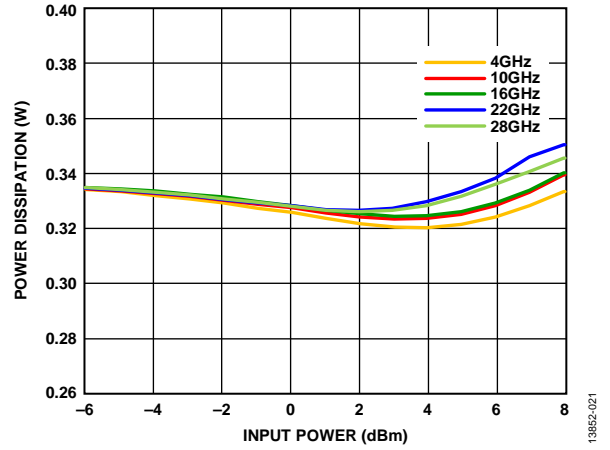

Figure 23. Power Dissipation vs. Input Power at Various Frequencies,  $T_A = 85^\circ C$

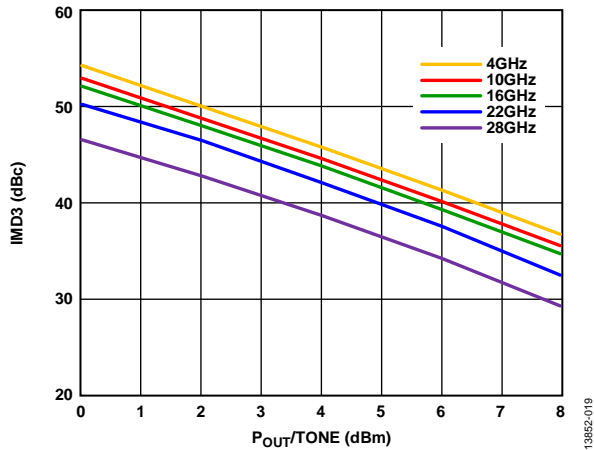

Figure 21. IMD3 vs.  $P_{out}/Tone$  for Various Frequencies at  $V_{DD} = 6 V$

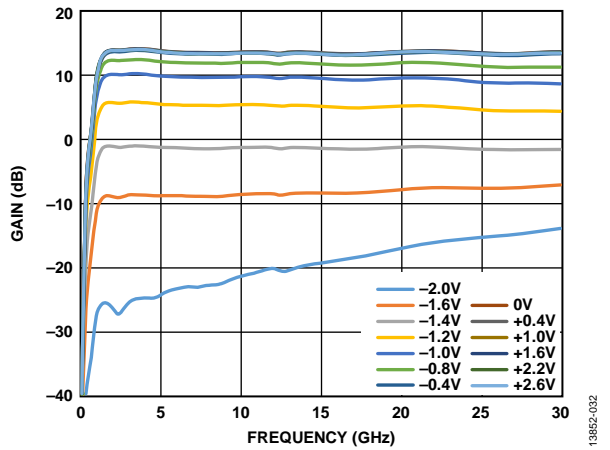

Figure 24. Gain vs. Frequency at Various  $V_{GG2}$  Voltage Levels

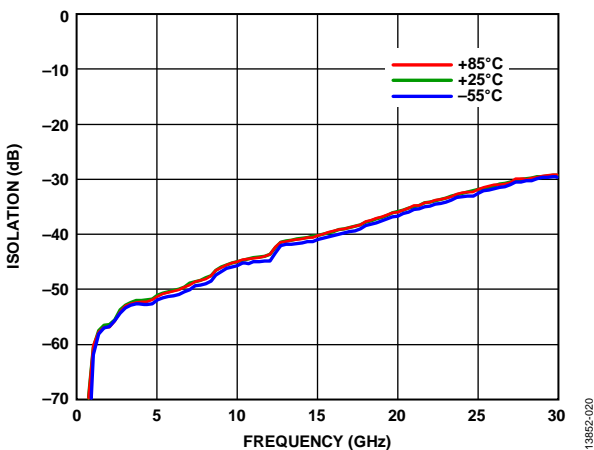

Figure 22. Reverse Isolation vs. Frequency at Various Temperatures

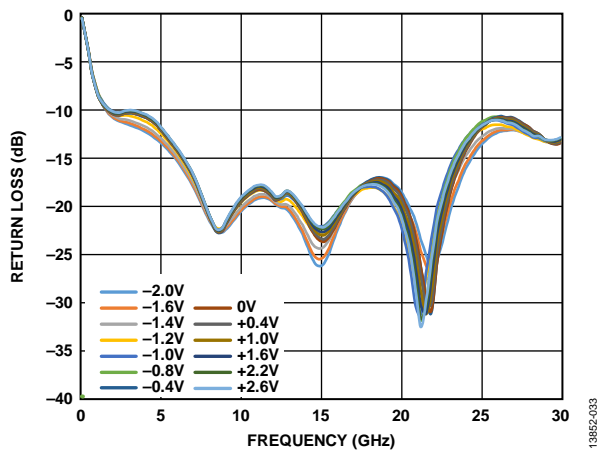

Figure 25. Input Return Loss vs. Frequency at Various  $V_{GG2}$  Voltage Levels

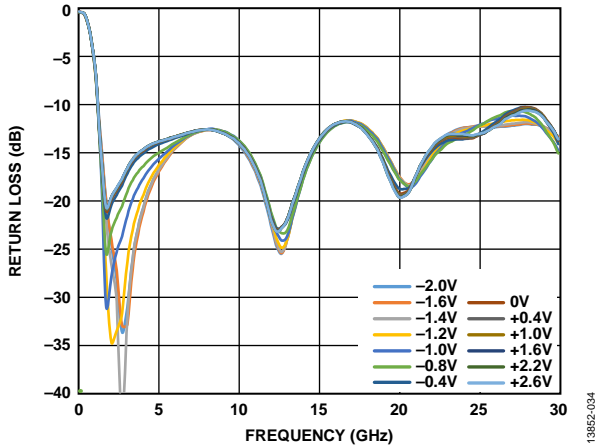

Figure 26. Output Return Loss vs. Frequency at Various  $V_{GG2}$  Voltage Levels

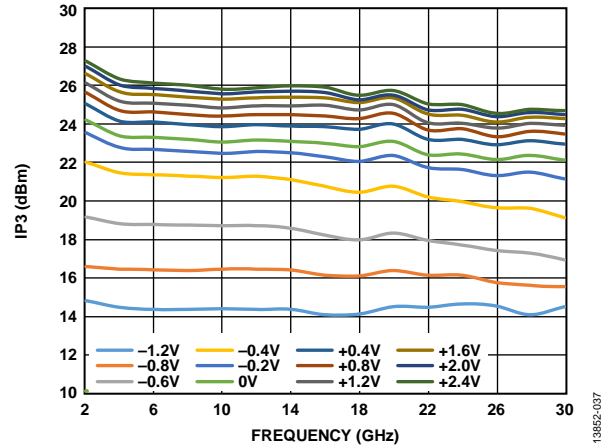

Figure 29. Output IP3 vs. Frequency at Various  $V_{GG2}$  Voltage Levels

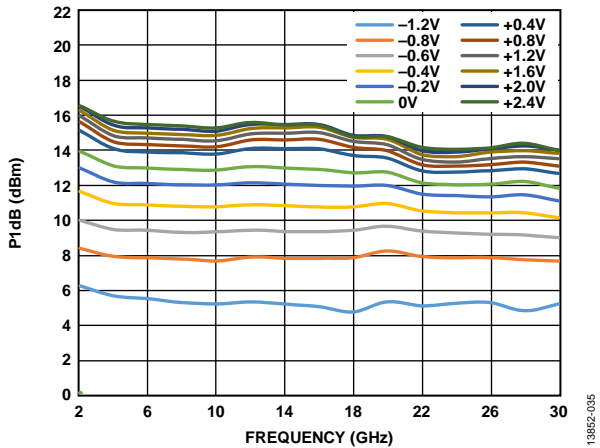

Figure 27. P1dB vs. Frequency at Various  $V_{GG2}$  Voltage Levels

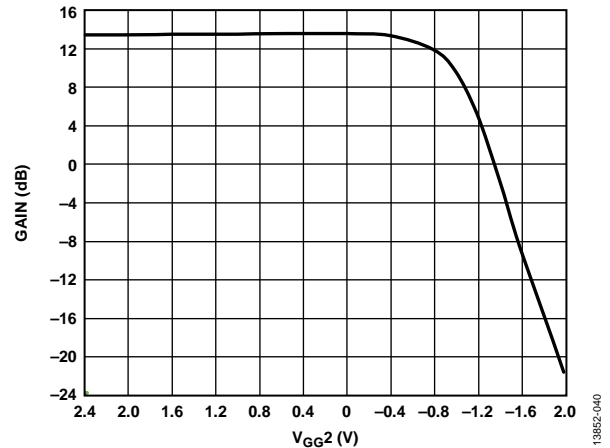

Figure 30. Gain vs.  $V_{GG2}$  at 10 GHz

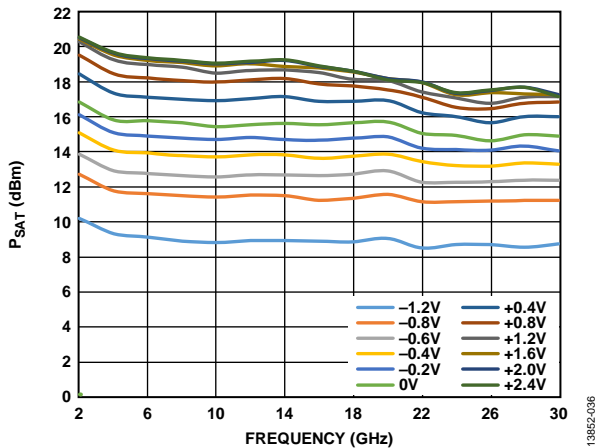

Figure 28.  $P_{SAT}$  vs. Frequency at Various  $V_{GG2}$  Voltage Levels

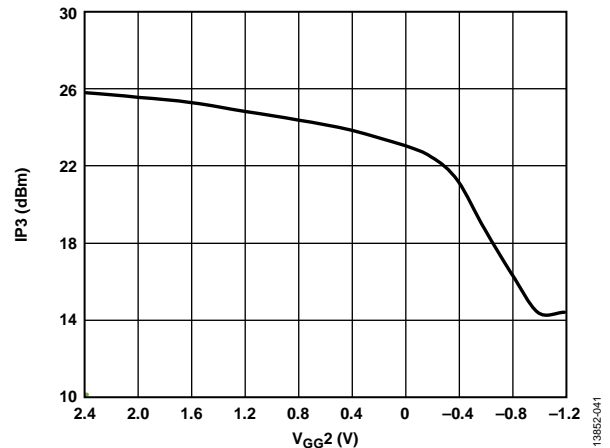

Figure 31. Output IP3 vs.  $V_{GG2}$  at 10 GHz

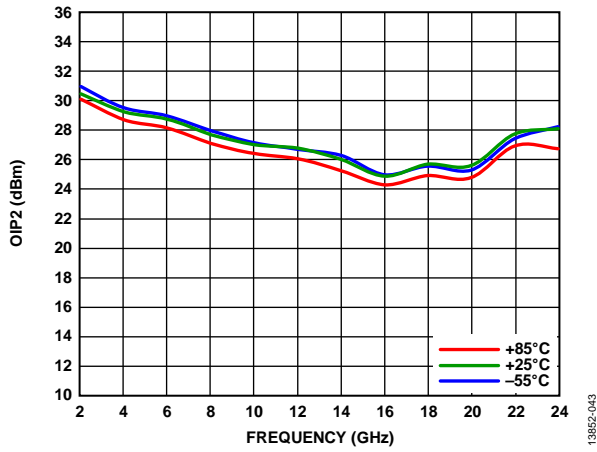

Figure 32. Output IP2 (OIP2) vs. Frequency for Various Temperatures at  $P_{OUT} = 0$  dBm/Tone

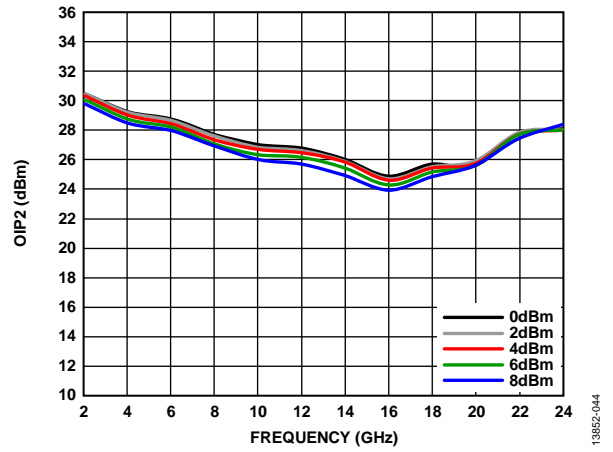

Figure 33. OIP2 vs. Frequency for Various  $P_{OUT}$ /Tone Levels

## THEORY OF OPERATION

The HMC8400 is a GaAs, pHEMT, MMIC low noise amplifier. The basic architecture is that of a self biased cascode distributed amplifier with an integrated RF choke for the drain. The cascode distributed architecture uses a fundamental cell consisting of a stack of two field effect transistors (FETs) connected from source to drain. The fundamental cell is then duplicated several times, with transmission lines interconnecting the drains of the top devices and the gates of the bottom devices, respectively.

Additional circuit design techniques are used around each cell to optimize the overall bandwidth and noise figure. The major benefit of this architecture is that a low noise figure is maintained across a bandwidth far greater than what a single instance of the fundamental cell provides. A simplified schematic of this architecture is shown in Figure 34.

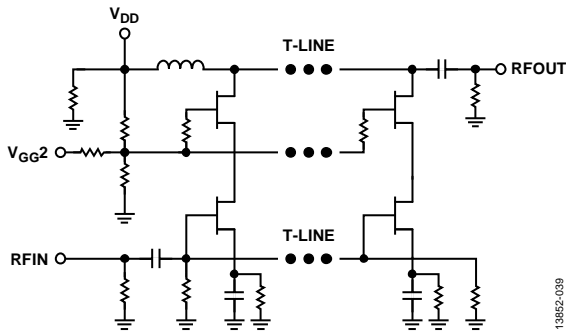

Figure 34. Architecture and Simplified Schematic

Though gate bias voltages are set internally via resistor connections and/or a resistive voltage divider tap off of  $V_{DD}$ , the  $V_{GG2}$  pad is provided to allow the user a means of changing the gate bias of the upper FETs. Application of a voltage to  $V_{GG2}$  changes the voltage output by a resistive divider, thus altering the gate bias of the upper FETs. Adjustment of the bias in this manner allows the user a 30 dB gain control function. For gain control,  $V_{GG2}$  voltages within the range of  $-2$  V through  $+2.6$  V can be applied. For  $V_{DD} = 5.0$  V dc, the  $V_{GG2}$  open-circuit voltage is approximately 2.0 V.

## APPLICATIONS INFORMATION

### BIASING PROCEDURES

Capacitive bypassing is required for  $V_{DD}$ , as shown in the typical application circuit in Figure 36. Gain control is possible through the application of a dc voltage to  $V_{GG2}$ . If gain control is used,  $V_{GG2}$  must be bypassed by 100 pF, 0.01  $\mu$ F, and 4.7  $\mu$ F capacitors. If gain control is not used,  $V_{GG2}$  can be either left open or capacitively bypassed as described.

The recommended bias sequence during power-up is as follows:

1. Set  $V_{DD}$  to 5 V (this results in an  $I_{DD}$  near the specified typical value).
2. If the gain control function is to be used, apply to  $V_{GG2}$  a voltage within the range of  $-2$  V to  $+2.6$  V until the desired gain is achieved.
3. Apply the RF input signal.

The recommended bias sequence during power-down is as follows:

1. Turn off the RF input signal.
2. Remove the  $V_{GG2}$  voltage or set it to 0 V.
3. Set  $V_{DD}$  to 0 V.

Unless otherwise noted, all measurements and data shown were taken using the typical application circuit (see Figure 36), configured as shown on the assembly diagram (see Figure 37) and biased per the conditions in the Specifications section. The bias conditions shown in the Specifications section are the operating points recommended to optimize the overall performance. Operation using other bias conditions can provide performance that differs from what is shown in this data sheet. To obtain the best performance while not damaging the device, follow the recommended biasing sequence outlined in this section.

### MOUNTING AND BONDING TECHNIQUES FOR MILLIMETERWAVE GaAs MMICs

Attach the die directly to the ground plane eutectically or with conductive epoxy. To bring RF to and from the chip, use 50  $\Omega$  microstrip transmission lines on 0.127 mm (5 mil) thick alumina thin film substrates (see Figure 35).

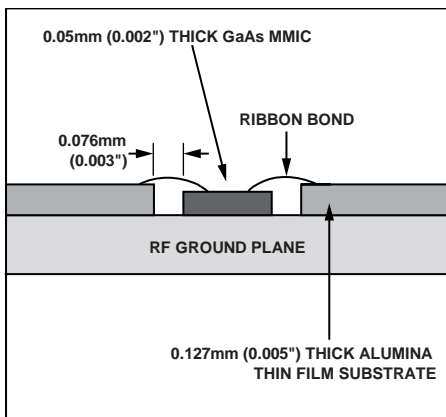

Figure 35. Routing RF Signals

To minimize bond wire length, place microstrip substrates as close to the die as possible. Typical die to substrate spacing is 0.076 mm to 0.152 mm (3 mil to 6 mil).

### Handling Precautions

To avoid permanent damage, adhere to the following precautions:

- All bare die ship in either wafer or gel-based ESD protective containers, sealed in an ESD protective bag. After the sealed ESD protective bag is opened, store all die in a dry nitrogen environment.
- Handle the chips in a clean environment. Never use liquid cleaning systems to clean the chip.
- Follow ESD precautions to protect against ESD strikes.
- While bias is applied, suppress instrument and bias supply transients. To minimize inductive pickup, use shielded signal and bias cables.
- Handle the chip along the edges with a vacuum collet or with a sharp pair of bent tweezers. The surface of the chip can have fragile air bridges and must not be touched with vacuum collet, tweezers, or fingers.

### Mounting

The chip is back metallized and can be die mounted with gold/tin (AuSn) eutectic preforms or with electrically conductive epoxy. The mounting surface must be clean and flat.

### Eutectic Die Attach

It is best to use an 80% gold/20% tin preform with a work surface temperature of 255°C and a tool temperature of 265°C. When hot 90% nitrogen/10% hydrogen gas is applied, maintain tool tip temperature at 290°C. Do not expose the chip to a temperature greater than 320°C for more than 20 sec. No more than 3 sec of scrubbing is required for attachment.

### Epoxy Die Attach

ABLETHERM 2600BT is recommended for die attachment. Apply a minimum amount of epoxy to the mounting surface so that a thin epoxy fillet is observed around the perimeter of the chip after placing it into position. Cure the epoxy per the schedule provided by the manufacturer.

### Wire Bonding

RF bonds made with 0.003 in.  $\times$  0.0005 in. gold ribbon are recommended for the RF ports. These bonds must be thermosonically bonded with a force of 40 g to 60 g. DC bonds of 1 mil (0.025 mm) diameter, thermosonically bonded, are recommended. Create ball bonds with a force of 40 g to 50 g and wedge bonds with a force of 18 g to 22 g. Create all bonds with a nominal stage temperature of 150°C. Apply a minimum amount of ultrasonic energy to achieve reliable bonds. Keep all bonds as short as possible, less than 12 mil (0.31 mm).

TYPICAL APPLICATION CIRCUIT

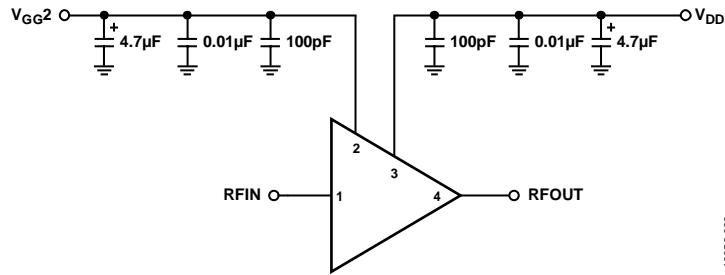

13862-023

Figure 36. Typical Application Circuit

ASSEMBLY DIAGRAM

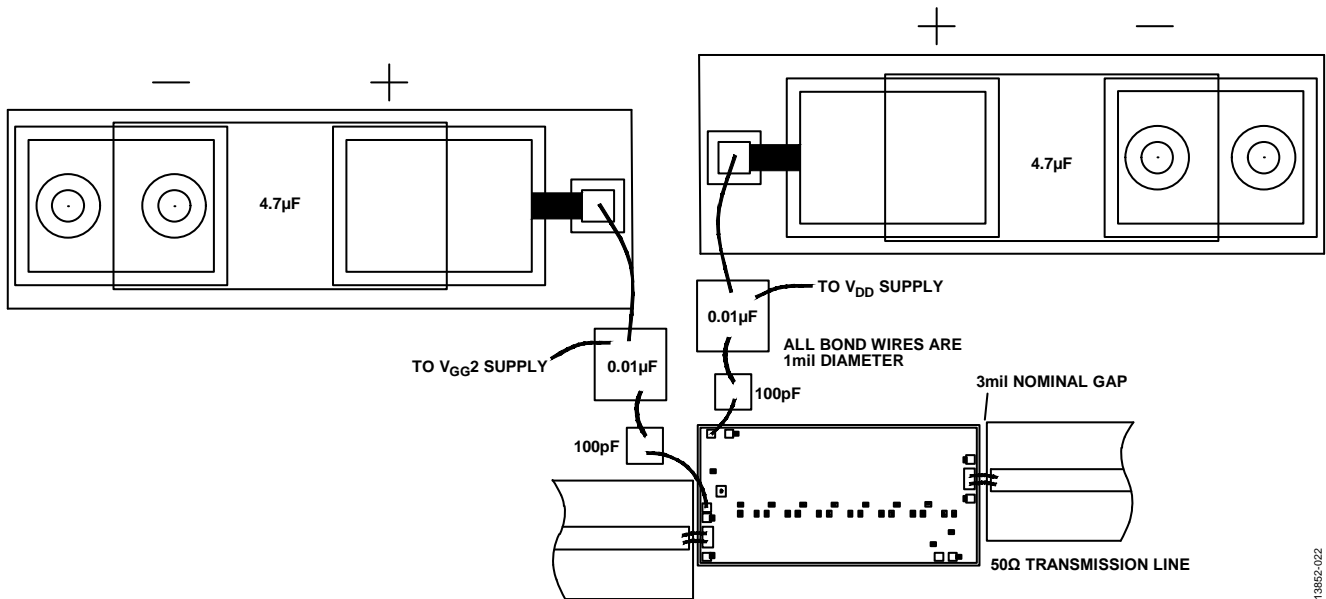

13862-022

Figure 37. Assembly Diagram

### OUTLINE DIMENSIONS

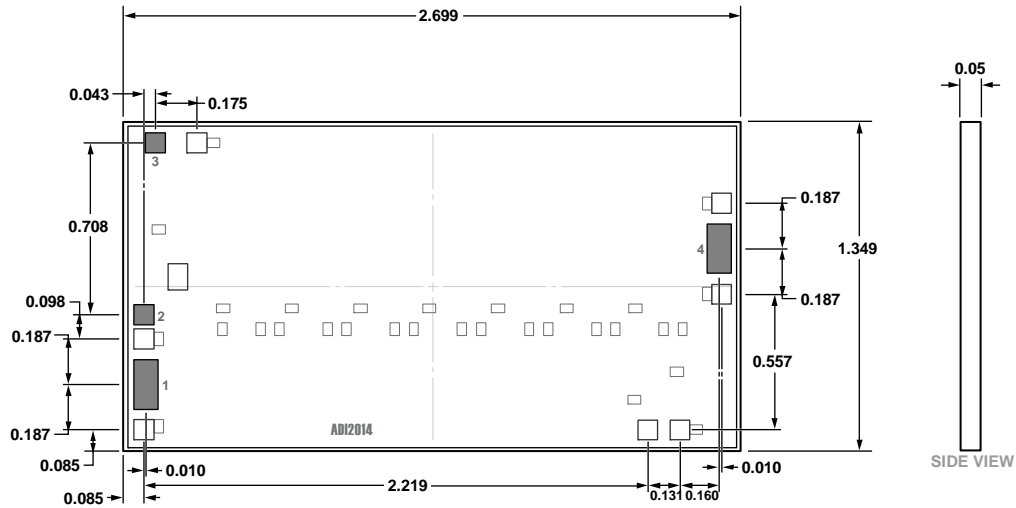

Figure 38. 4-Pad Bare Die [CHIP]  
(C-4-1)  
Dimensions shown in millimeters

### ORDERING GUIDE

Model	Temperature Range	Package Description	Package Option
HMC8400	-55°C to +85°C	4-Pad Bare Die [CHIP]	C-4-1
HMC8400-SX	-55°C to +85°C	4-Pad Bare Die [CHIP]	C-4-1



Компания «ЭлектроПласт» предлагает заключение долгосрочных отношений при поставках импортных электронных компонентов на взаимовыгодных условиях!

Наши преимущества:

- Оперативные поставки широкого спектра электронных компонентов отечественного и импортного производства напрямую от производителей и с крупнейших мировых складов;
- Поставка более 17-ти миллионов наименований электронных компонентов;
- Поставка сложных, дефицитных, либо снятых с производства позиций;
- Оперативные сроки поставки под заказ (от 5 рабочих дней);
- Экспресс доставка в любую точку России;
- Техническая поддержка проекта, помощь в подборе аналогов, поставка прототипов;
- Система менеджмента качества сертифицирована по Международному стандарту ISO 9001;
- Лицензия ФСБ на осуществление работ с использованием сведений, составляющих государственную тайну;
- Поставка специализированных компонентов (Xilinx, Altera, Analog Devices, Intersil, Interpoint, Microsemi, Aeroflex, Peregrine, Syfer, Eurofarad, Texas Instrument, Miteq, Cobham, E2V, MA-COM, Hittite, Mini-Circuits, General Dynamics и др.);

Помимо этого, одним из направлений компании «ЭлектроПласт» является направление «Источники питания». Мы предлагаем Вам помощь Конструкторского отдела:

- Подбор оптимального решения, техническое обоснование при выборе компонента;
- Подбор аналогов;
- Консультации по применению компонента;
- Поставка образцов и прототипов;
- Техническая поддержка проекта;
- Защита от снятия компонента с производства.



#### Как с нами связаться

**Телефон:** 8 (812) 309 58 32 (многоканальный)

**Факс:** 8 (812) 320-02-42

**Электронная почта:** [org@eplast1.ru](mailto:org@eplast1.ru)

**Адрес:** 198099, г. Санкт-Петербург, ул. Калинина, дом 2, корпус 4, литера А.