

LOC		DIST		REVISIONS			
ES	00	P	LTM	DESCRIPTION	DATE	DWN	APVD
		J1		REV PER ECR-12-016975	25SEP2012	CZ	SZ
		J3		ADDED NEW DASH NUMBER 4-0	01FEB2013	CZ	SZ
		J5		ADDED NEW DASH NUMBER 4-1	25FEB2014	CZ	SZ

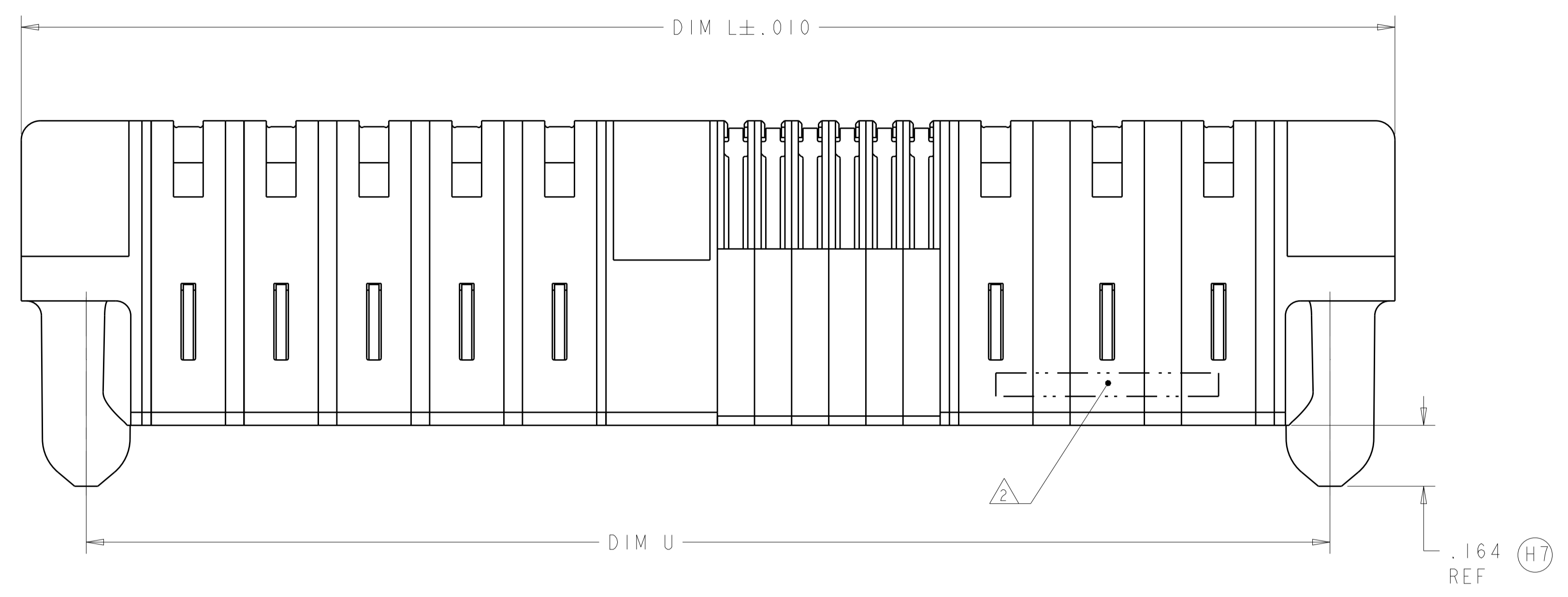

- △1 OPTIONAL CENTER MODULE, WITH .150 THRU HOLE OR HOLD DOWN FEATURE.
- △2 "AMP", PART NUMBER AND DATE CODE TO BE MARKED
- △3 MATERIAL: HOUSING - GLASS FILLED HIGH TEMP THERMO PLASTIC, UL94 V-O.  
 SIGNAL CONTACT - HIGH CONDUCTIVITY COPPER ALLOY  
 POWER CONTACT - HIGH CONDUCTIVITY COPPER ALLOY
- △4 CONTACT PLATING: NOBLE METAL PLATING ON CONTACT FUNCTIONAL AREA OF POWER AND SIGNAL CONTACTS
- △5 MECHANICAL CONNECTOR KEEP OUT ZONE.
- △6 DATUM AND BASIC DIMENSIONS ESTABLISHED BY CUSTOMER.
- △7 PCB - ALL HOLE DIAMETERS ARE FINISHED HOLE SIZES
- △8 PCB - .0453±.0010 DRILLED HOLES PLATED WITH .0003 MIN Sn OVER .001 TO .003 Cu PLATING TO ACHIEVE A .040 DIAMETER HOLE

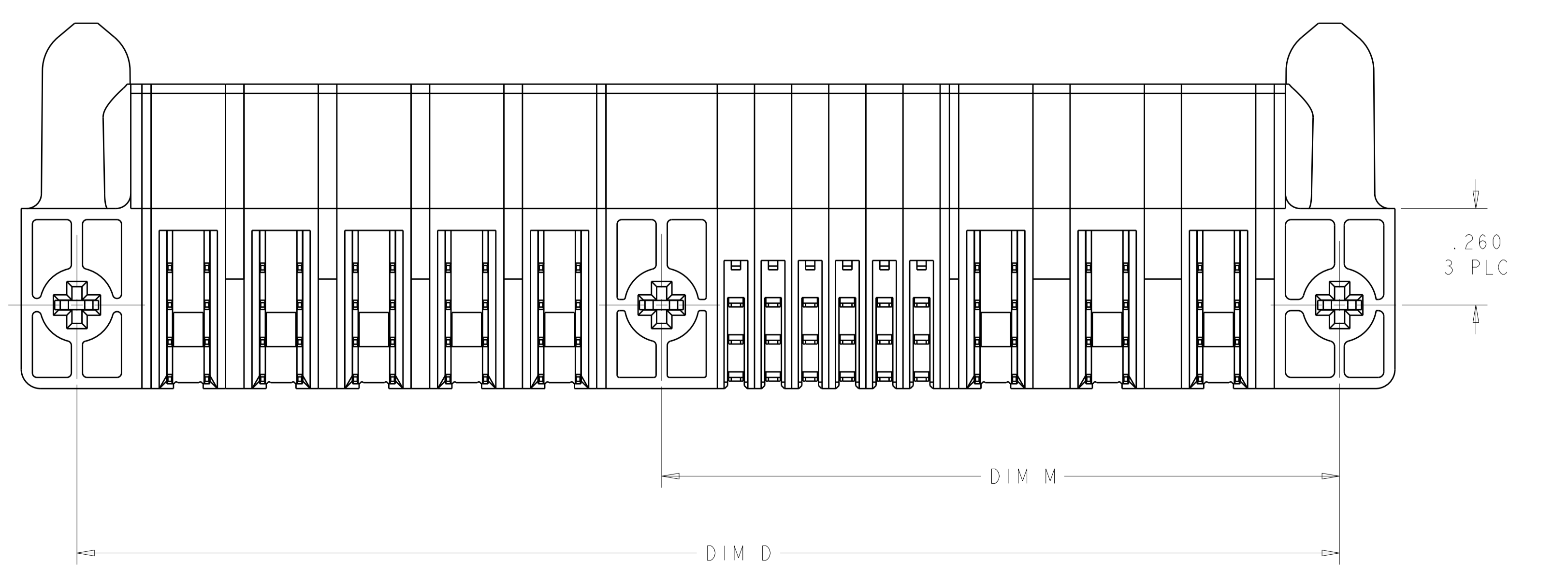
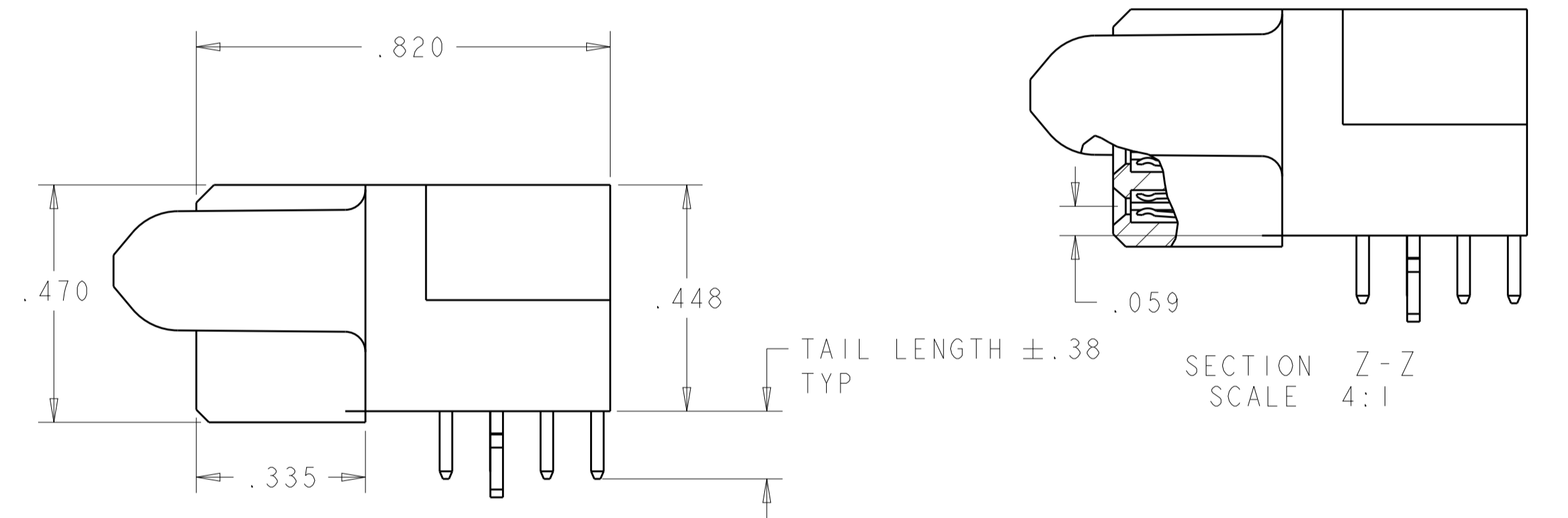
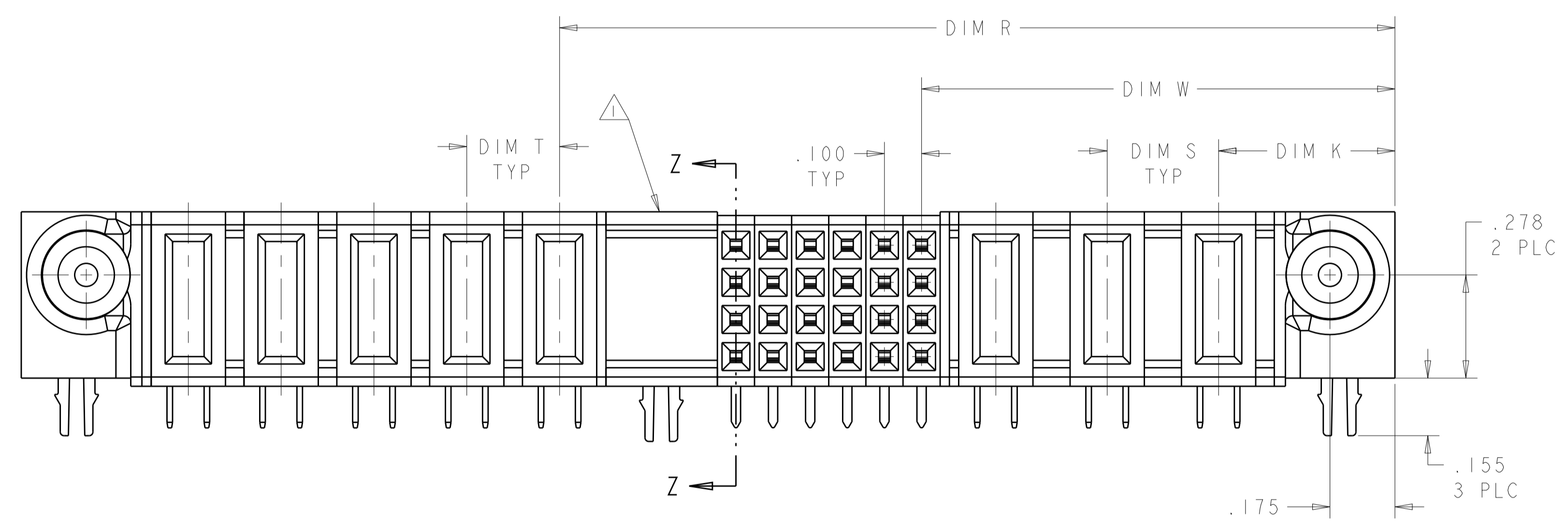

THIS DRAWING IS A CONTROLLED DOCUMENT.

DWN: R. GRZYBOWSKI 21FEB05  
 CHK: M. PERCHERKE 21FEB05  
 APVD: M. PERCHERKE

TE Connectivity

NAME: RIGHT ANGLE RECEPTACLE ASSEMBLY WITH GUIDES MULTI-BEAM XL

PRODUCT SPEC: 108-1973  
 APPLICATION SPEC: 114-13038

SIZE: A1  
 CAGE CODE: 6450170  
 DRAWING NO: 100779

RESTRICTED TO: -

MATERIAL: △3  
 FINISH: △4

CUSTOMER DRAWING

SCALE: 4:1  
 SHEET: 1 OF 13  
 REV: J5

THIS DRAWING IS UNPUBLISHED. RELEASED FOR PUBLICATION 20  
 © COPYRIGHT 20 BY - ALL RIGHTS RESERVED.

LOC	DIST	REVISIONS					
		P	LTN	DESCRIPTION	DATE	DWN	APVD
ES	00	-	-	SEE SHEET 1	-	-	-

J4	2.650	.200	.250	1.550	.875	2.700	-	3.000	.450	2P + 24S + 6P	4-6450170-1
	3.100	.250	.250	2.250	1.875	3.150	-	3.450	.450	6P + 12S + 4P	4-6450170-0
	1.900	.250	.300	1.550	1.275	1.950	-	2.250	.475	3ACP + 8S + 2P	3-6450170-9
	1.800	-	-	1.700	.625	1.850	-	2.150	.450	1P + 40S + 1P	3-6450170-8
	1.600	-	-	1.500	.625	1.650	-	1.950	.450	1P + 32S + 1P	3-6450170-7
	1.700	.250	.250	1.350	.875	1.750	-	2.050	.450	2P + 16S + 2P	3-6450170-6
	1.550	.250	.250	1.200	.900	1.600	-	1.900	.450	2P + 8S + 2P	3-6450170-5
	2.350	.250	.250	1.250	.875	2.400	-	2.700	.450	2P + 12S + 5P	3-6450170-4
	2.325	.250	.300	1.975	1.600	2.375	-	2.675	.450	4ACP + 12S + 2P	3-6450170-3
	1.700	.250	.250	1.350	.875	1.750	-	2.050	.450	2P + 16S + 2P	3-6450170-1
	2.300	.250	.300	1.950	1.275	2.350	-	2.650	.450	3ACP + 24S + 2P	3-6450170-0
	2.400	.250	.250	1.800	1.125	2.450	-	2.750	.450	3P + 24S + 3P	2-6450170-9
	2.300	.250	.300	1.950	1.275	2.350	-	2.650	.450	3ACP + 24S + 2P	2-6450170-8
	2.400	.250	.250	1.800	1.125	2.450	-	2.750	.450	3P + 24S + 3P	2-6450170-7
	1.950	.250	.250	1.600	1.125	2.000	-	2.300	.450	3P + 16S + 2P	2-6450170-6
	1.300	-	-	1.200	.675	1.350	-	1.650	.450	1P + 16S + 1P	2-6450170-0
	2.200	.250	.250	1.350	.875	2.250	-	2.550	.450	2P + 16S + 4P	1-6450170-9
	2.800	.300	.250	2.075	1.375	2.850	-	3.150	.450	4P + 24S + 3ACP	1-6450170-8
	3.000	.250	.250	2.150	1.425	3.050	-	3.350	.450	4P + 24S + 4P	1-6450170-4
	2.600	.200	.200	1.925	1.175	2.650	-	2.950	.425	4P + 28S + 4P	1-6450170-1
	1.575	-	-	1.425	.700	1.625	-	1.925	.475	1P + 24S + 1P	1-6450170-0
	2.500	.250	.250	2.150	.875	2.550	-	2.850	.450	2P + 48S + 2P	6450170-9
	3.300	.250	.300	1.950	1.275	3.350	-	3.650	.475	3ACP + 24S + 6P	6450170-8
	1.400	.250	.250	1.300	.625	1.450	-	1.750	.450	1P + 24S + 1P	6450170-6
	2.400	.250	.250	1.800	1.125	2.450	-	2.750	.450	3P + 24S + 3P	6450170-5
	4.350	.250	.250	3.500	2.625	4.400	-	4.700	.450	9P + 32S + 4P	6450170-4
	3.650	.250	.300	2.550	1.275	3.700	-	4.000	.475	3ACP + 48S + 5P	6450170-3
	3.050	.250	.300	1.950	1.275	3.100	-	3.400	.475	3ACP + 24S + 5P	6450170-2
	2.550	.250	.300	2.200	1.525	2.600	-	2.900	.475	3ACP + 1P + 24S + 2P	6450170-1
	DIM U	DIM T	DIM S	DIM R	DIM W	DIM D	DIM M	DIM L	DIM K	DESCRIPTION	PART NUMBER

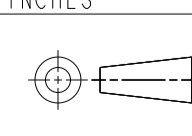
THIS DRAWING IS A CONTROLLED DOCUMENT.		DWN R. GRZYBOWSKI CHK M. PERCHERKE	Z1FEB05 Z1FEB05	 TE Connectivity
DIMENSIONS: INCHES		TOLERANCES UNLESS OTHERWISE SPECIFIED:		
 0 PLC ±. 1 PLC ±.01 2 PLC ±.01 3 PLC ±.005 4 PLC ±.002 ANGLES ±.02°		APVD M. PERCHERKE		NAME RIGHT ANGLE RECEPTACLE ASSEMBLY WITH GUIDES MULTI-BEAM XL
MATERIAL		FINISH		RESTRICTED TO
CUSTOMER DRAWING		WEIGHT		SIZE A100779
SCALE 4:1		DRAWING NO. C=6450170		SHEET 2 OF 13
				REV J5

NO CONTACT

PART NUMBER	ROWS	POWER				SIGNAL				POWER					
		P6	P5	P4	P3	6	5	4	3	2	1	P4	P3	P2	P1
6450170-1	D C B A	RM	RM	RM	RM	H	H	H	H	H	H	H	RA	RM	RM
		3ACP + 1P + 24S + 2P													

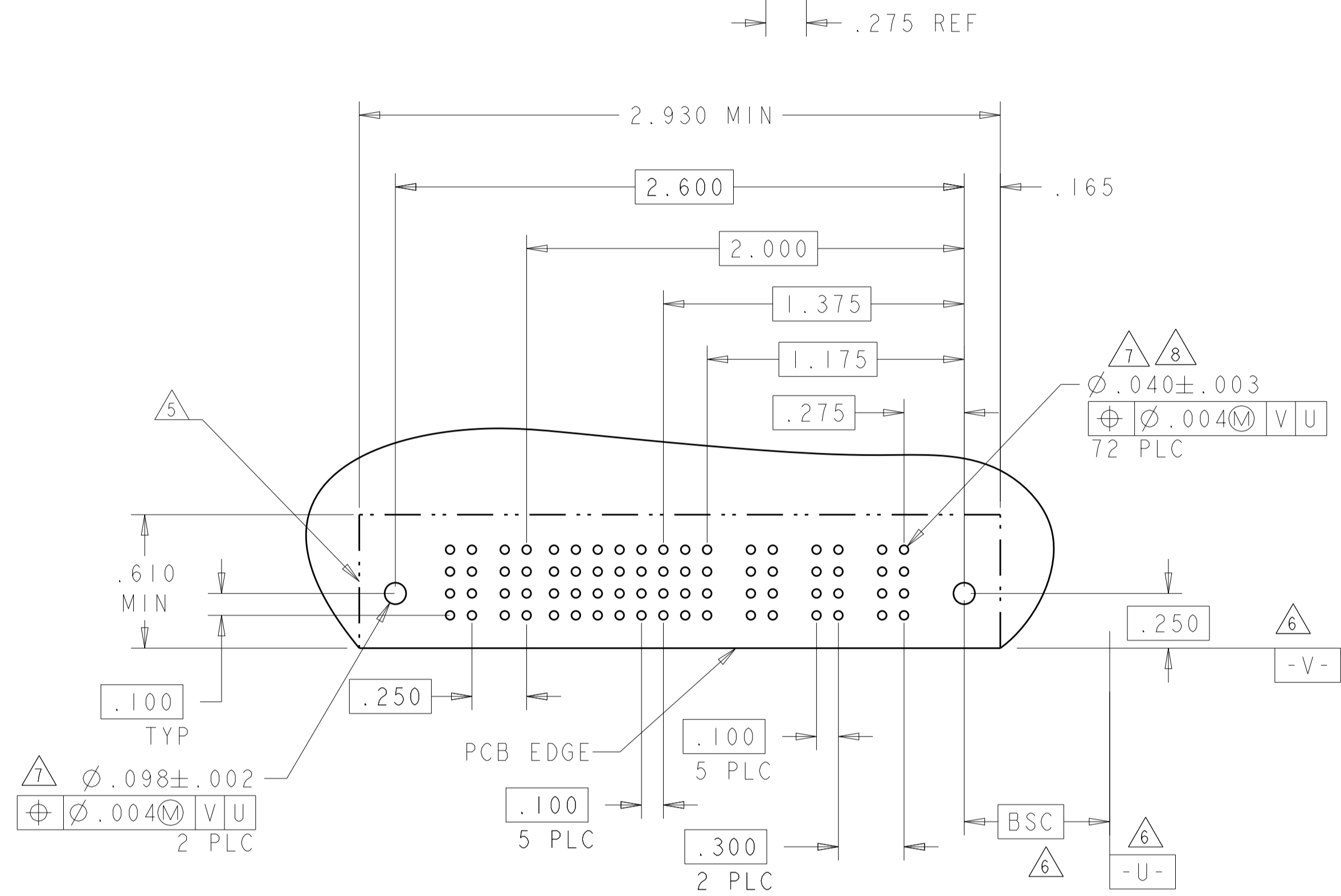

PART NUMBER	ROWS	POWER				SIGNAL				POWER					
		P8	P7	P6	P5	P4	6	5	4	3	2	1	P3	P2	P1
6450170-2	D C B A	RM	RM	RM	RM	H	H	H	H	H	H	H	RA	RM	RM
		3ACP + 24S + 5P													

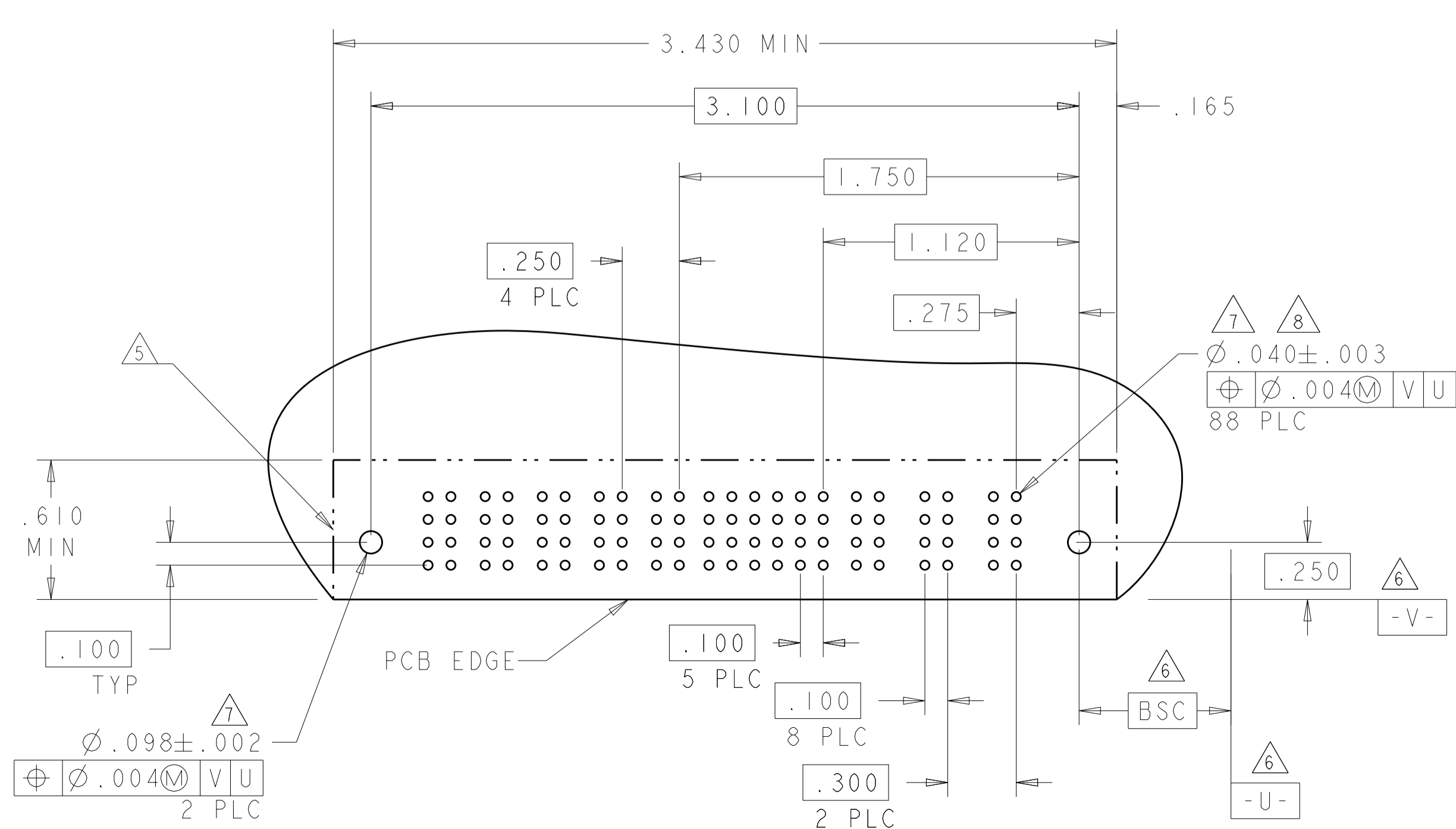

PART NUMBER	ROWS	POWER				SIGNAL											POWER					
		P8	P7	P6	P5	P4	12	11	10	9	8	7	6	5	4	3	2	1	P3	P2	P1	
6450170-3	D C B A	RM	RM	RM	RM	H	H	H	H	H	H	H	H	H	H	H	H	H	RA	RM	RM	
		3ACP + 48S + 5P																				

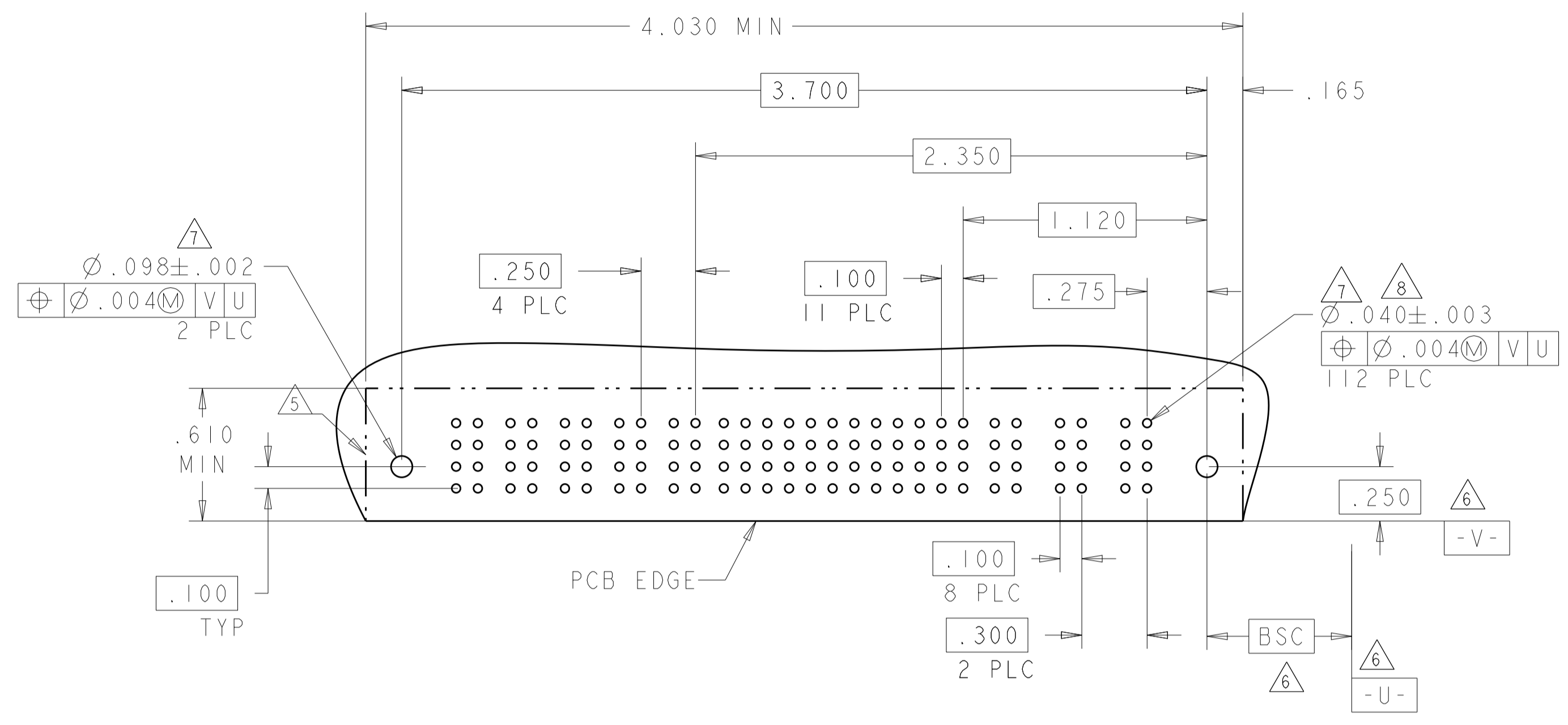

NO CONTACT

PART NUMBER	ROWS	POWER				SIGNAL											POWER							
		P13	P12	P11	P10	8	7	6	5	4	3	2	1	P9	P8	P7	P6	P5	P4	P3	P2	P1		
6450170-4	D C B A	RM	RM	RA	RM	H	H	H	H	H	H	H	H	RM	RM	RM	RM	RM	RM	RA	RM	RM		
		J <sup>2</sup>   3c3   4P																						

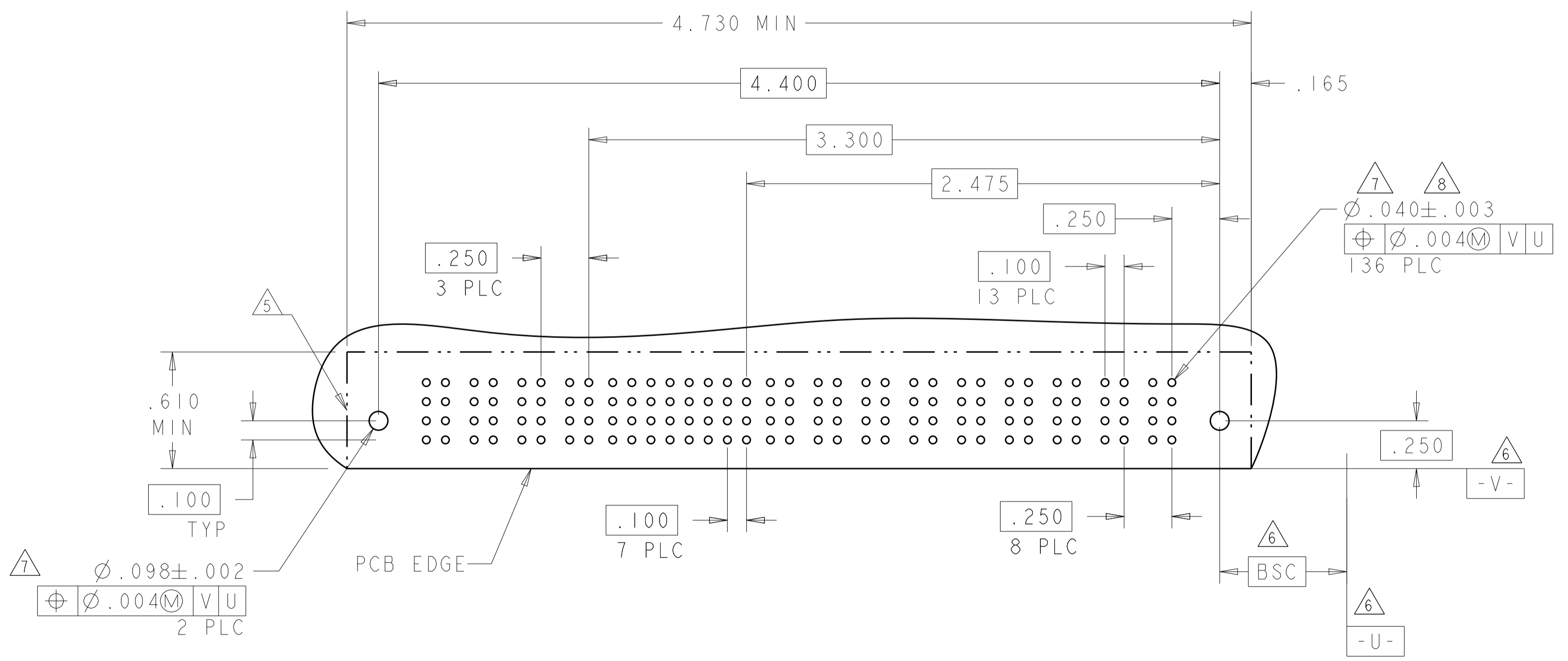

RM	.135	STD	F	.135	B
RA	.135	MFBL	E	.135	A
CODE	TAIL LENGTH	TYPE	CODE	TAIL LENGTH	ROW
POWER CONTACT			SIGNAL CONTACT		

THIS DRAWING IS A CONTROLLED DOCUMENT.

DIMENSIONS: INCHES	TOLERANCES UNLESS OTHERWISE SPECIFIED:	OWN: R. GRZYBOWSKI	21FEB05
0 PLC ±.01	1 PLC ±.01	CHK: M. PERCHERKE	21FEB05
2 PLC ±.01	3 PLC ±.01	APV: M. PERCHERKE	
4 PLC ±.002	5 PLC ±.005	PRODUCT SPEC	
ANGLES ±.020		108-1973	
		APPLICATION SPEC	
		114-13038	
		WEIGHT	
		FINISH	
		CUSTOMER DRAWING	

NAME: RIGHT ANGLE RECEPTACLE ASSEMBLY WITH GUIDES MULTI-BEAM XL

SIZE: A1 | CAGE CODE: DRAWING NO: 100779 | DRAWING NO: 6450170

RESTRICTED TO: SCALE: 1:1 | SHEET 3 OF 13 | REV J5

LOC	DIST	REVISIONS			
ES	00	REV	DATE	BY	APPV
		1			
		SEE SHEET 1			

PART NUMBER	ROWS	POWER			SIGNAL					POWER				
		P6	P5	P4	6	5	4	3	2	1	P3	P2	P1	
6450170-5	D C B A	RA	RM	RM	H	H	H	H	H	H	H	RM	RM	RA
					G	G	G	G	G	G	G			
					F	F	F	F	F	F	F			
					E	E	E	E	E	E	E			

3P + 24S + 3P

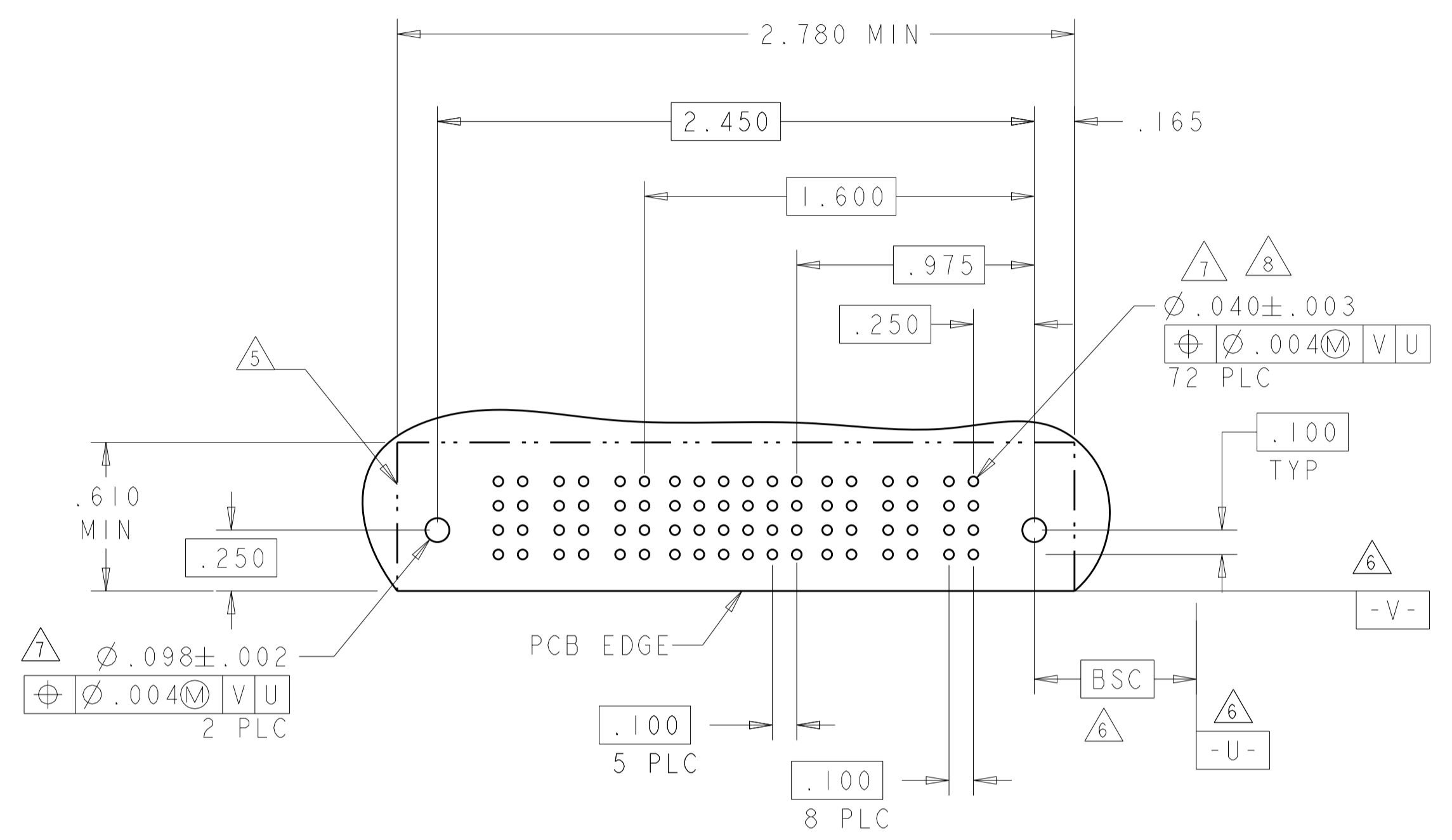

PART NUMBER	ROWS	POWER		SIGNAL					POWER			
		P2	P1	6	5	4	3	2	1	P2	P1	
6450170-6	D C B A	RB	RA	L	L	L	L	L	L	L	RM	RA
				K	K	K	K	K	K	K		
				J	J	J	J	J	J	J		
				I	I	I	I	I	I	I		

1P + 24S + 1P

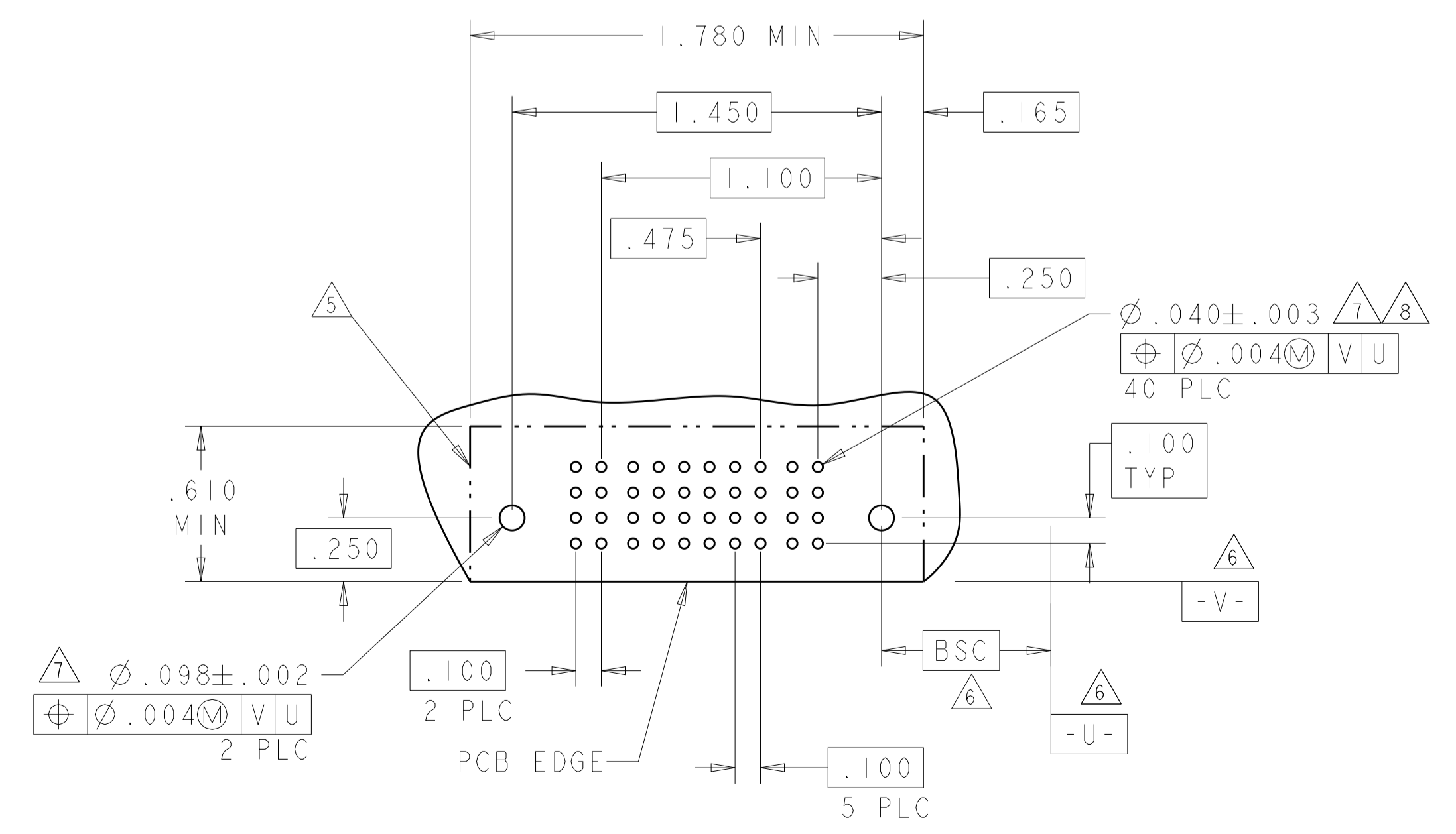

PART NUMBER	ROWS	POWER					SIGNAL					POWER				
		P9	P8	P7	P6	P5	P4	6	5	4	3	2	1	P3	P2	P1
6450170-8	D C B A	RM	RM	RM	RM	RM	RM	H	H	H	H	H	H	RA	RM	RM
							G	G	G	G	G	G	G			
							F	F	F	F	F	F	F			
							E	E	E	E	E	E	E			

3ACP + 24S + 6P

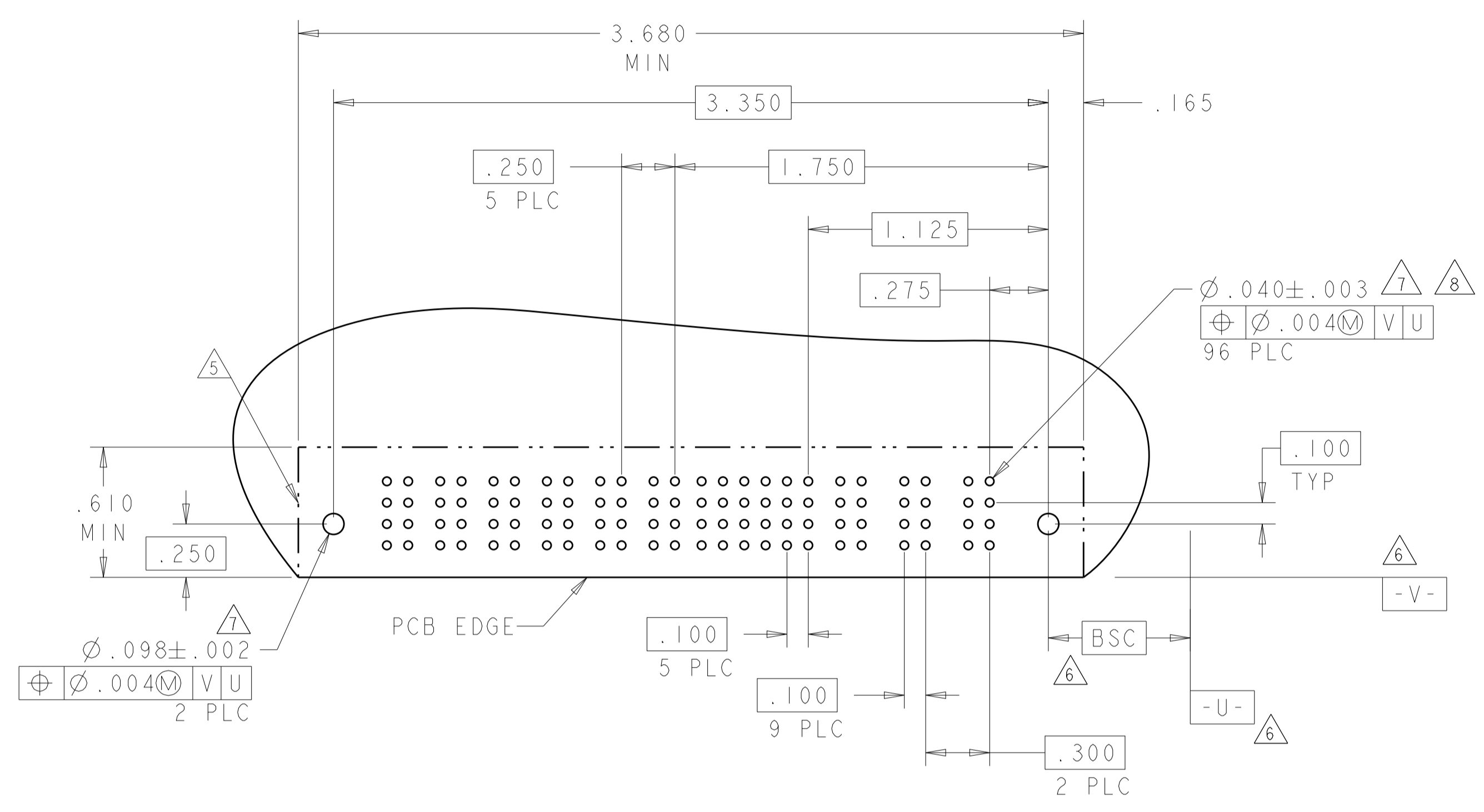

PART NUMBER	ROWS	POWER		SIGNAL										POWER			
		P4	P3	12	11	10	9	8	7	6	5	4	3	2	1	P2	P1
6450170-9	D C B A	RM	RA	H	H	H	H	H	H	H	H	H	H	H	H	RM	RA
				G	G	G	G	G	G	G	G	G	G	G	G		
				F	F	F	F	F	F	F	F	F	F	F			
				E	E	E	E	E	E	E	E	E	E	E			

2P + 48S + 2P

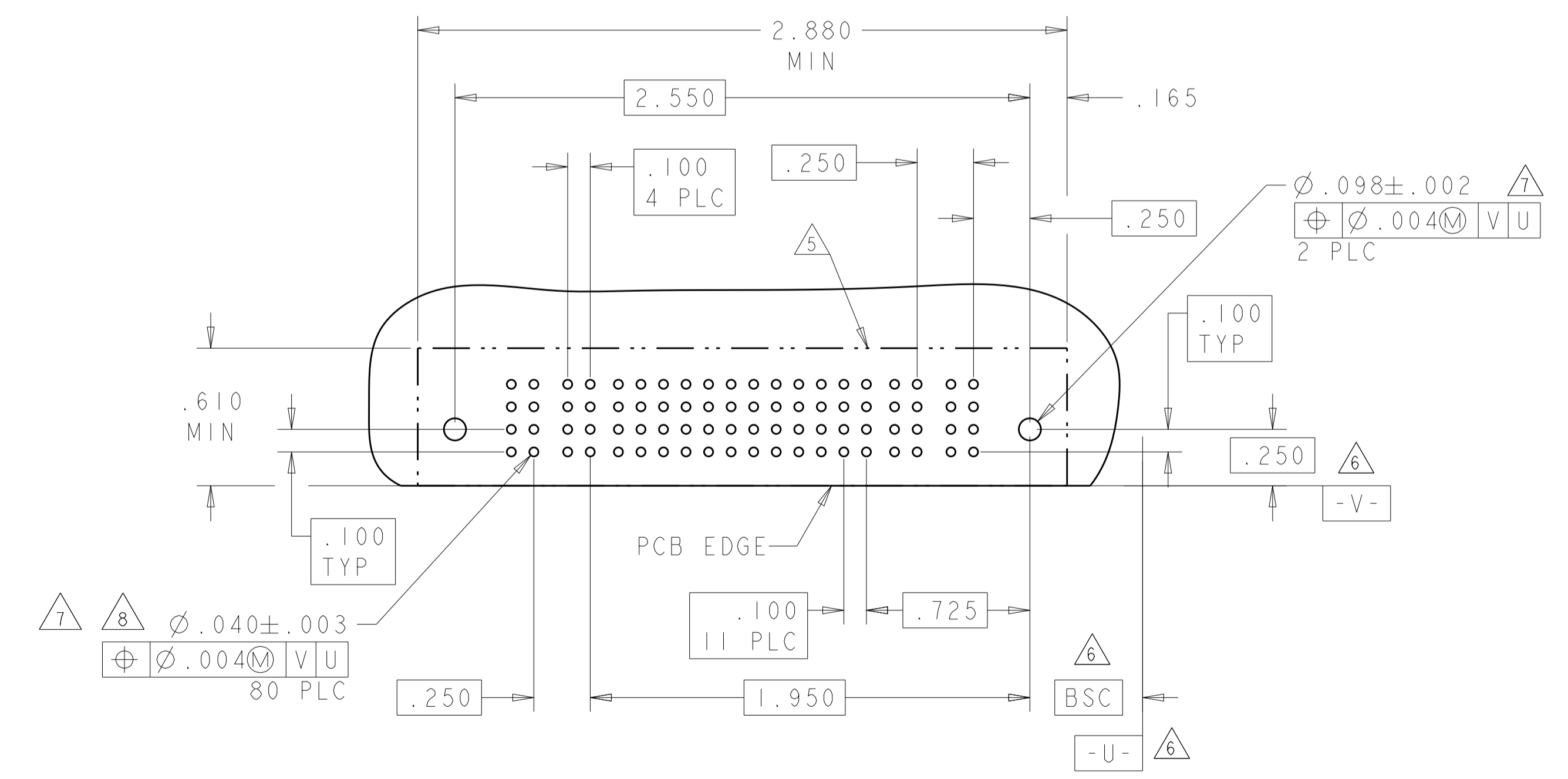

THIS DRAWING IS A CONTROLLED DOCUMENT.

DIMENSIONS:	TOLERANCES UNLESS OTHERWISE SPECIFIED:	DRN: R. GRZYBOWSKI	21FEB05
INCHES	0 PLC ± .01	CHK: M. PERCHERKE	21FEB05
	1 PLC ± .01	APPV: M. PERCHERKE	
	2 PLC ± .01	PRODUCT SPEC	
	3 PLC ± .01	APPLICATION SPEC	
	4 PLC ± .002	108-1973	
	ANGLES ± .002	114-13038	
MATERIAL:	FINISH:	WEIGHT:	

NAME: RIGHT ANGLE RECEPTACLE ASSEMBLY WITH GUIDES MULTI-BEAM XL

SIZE: 100779 C=6450170

CUSTOMER DRAWING SCALE: 4:1 SHEET 4 OF 13 REV J5



LOC	DIST	REV	DATE	APP'D
ES	00			

REVISIONS				
NO.	DESCRIPTION	DATE	BY	APP'D
-	SEE SHEET 1	-	-	-

PART NUMBER	ROWS	POWER				SIGNAL				POWER	
		P6	P5	P4	P3	4	3	2	1	P2	P1
I-6450170-9	D C B A	RA	RA	RM	RM	H	H	H	H	RM	RA
						G	G	G	G		
						F	F	F	F		
						E	E	E	E		
2P + 16S + 4P		HD								HD	

PART NUMBER	ROWS	POWER				SIGNAL						POWER			
		P8	P7	P6	P5	6	5	4	3	2	1	P4	P3	P2	P1
I-6450170-4	D C B A	RA	RA	RA	RA	H	H	H	H	H	H	RA	RA	RA	RA
						G	G	G	G	G	G				
						F	F	F	F	F	F				
						E	E	E	E	E					
4P + 24S + 4P		HD										HD			

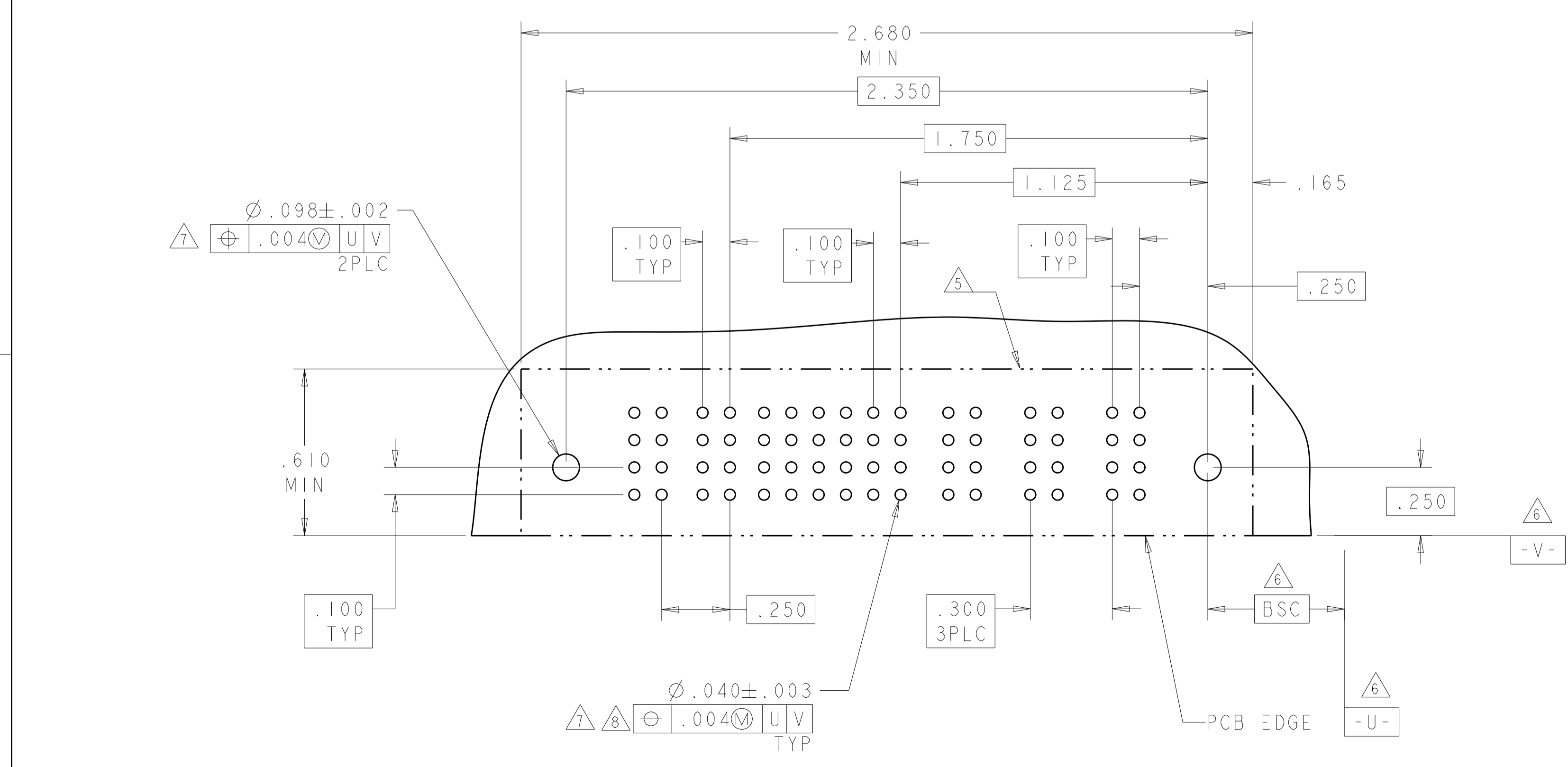
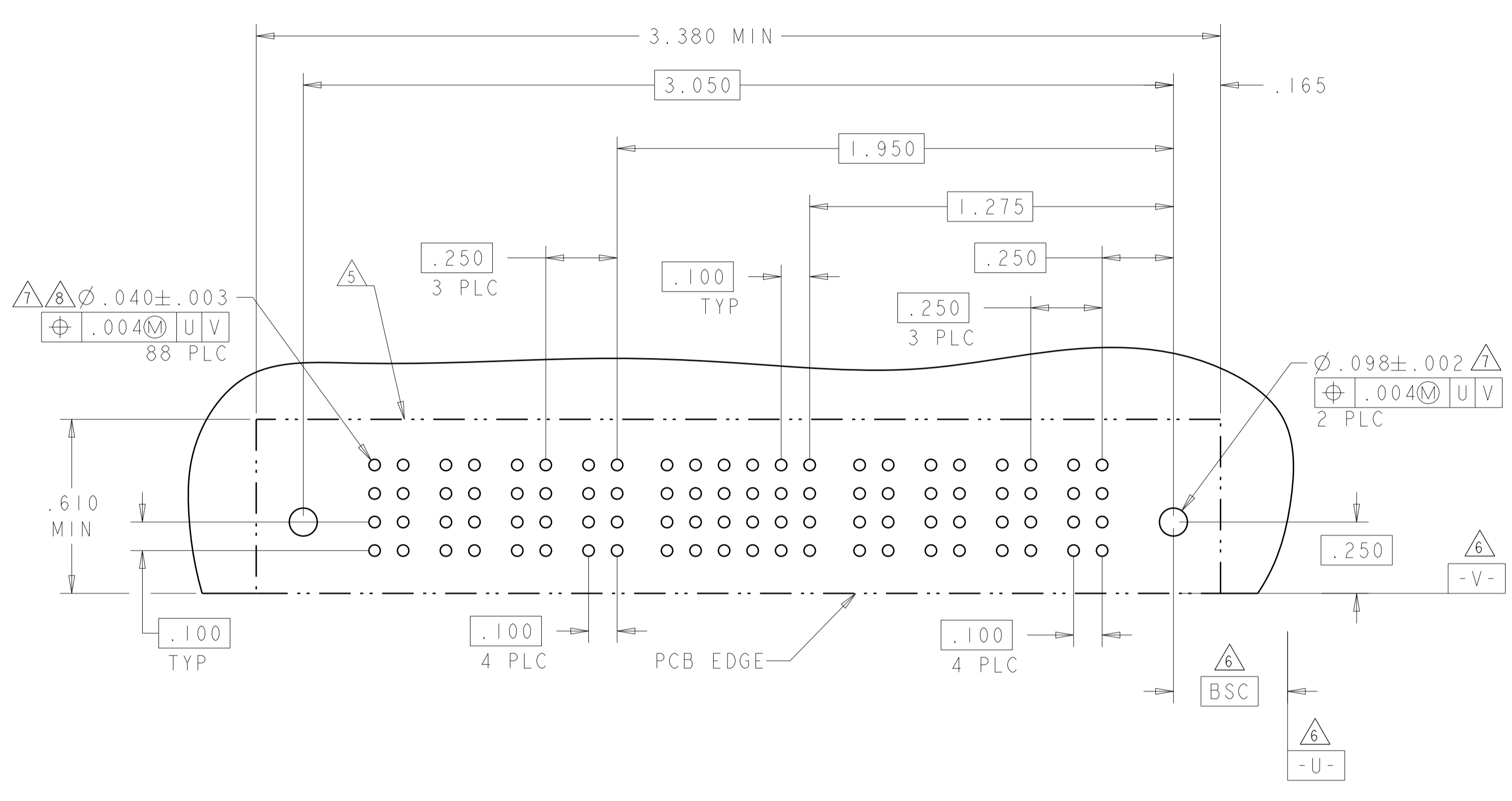
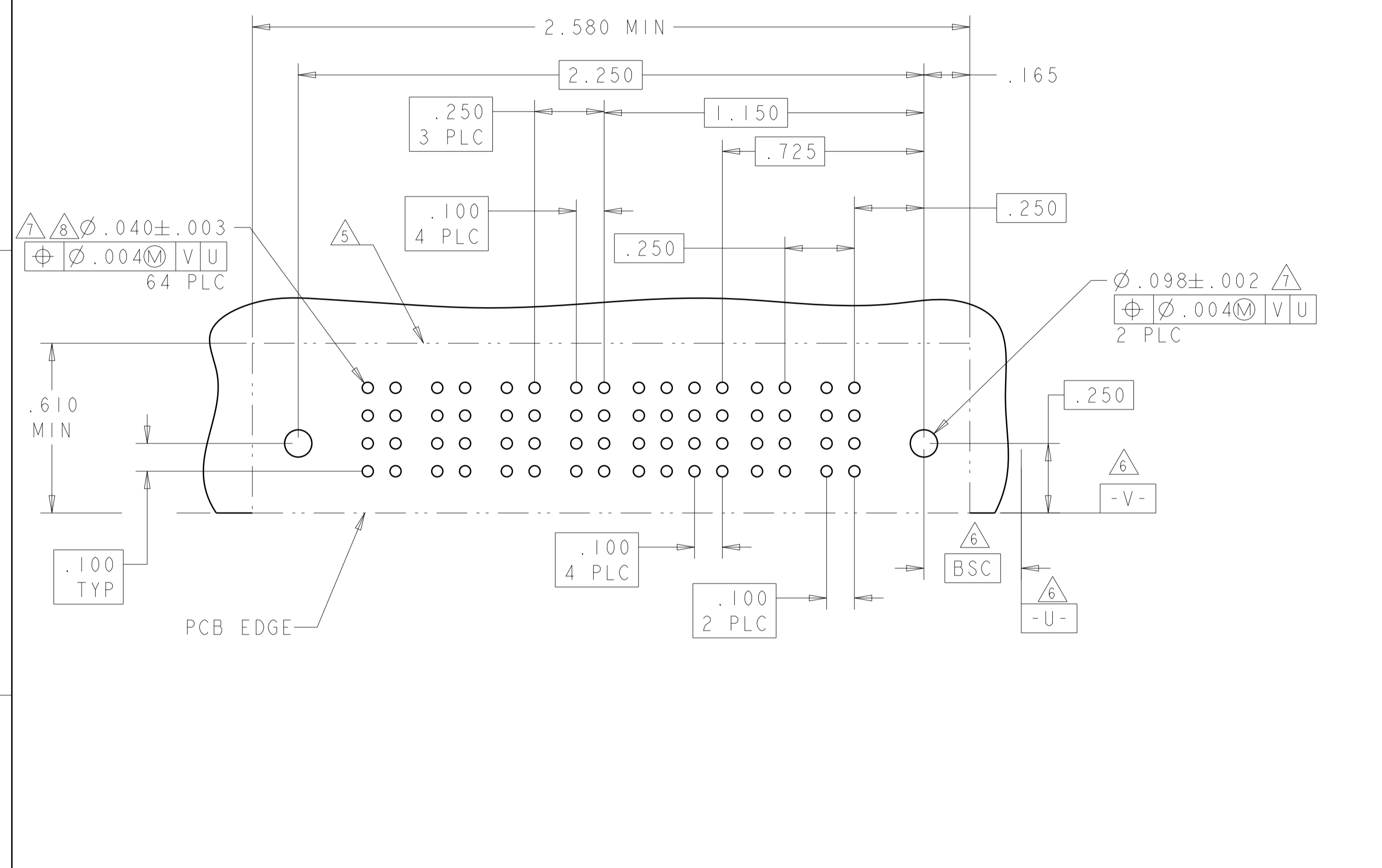

PART NUMBER	ROWS	POWER		SIGNAL						AC POWER		
		P5	P4	6	5	4	3	2	1	P3	P2	P1
2-6450170-8	D C B A	RA	RA	H	H	H	H	H	H	RA	RM	RM
				G	G	G	G	G	G			
				F	F	F	F	F	F			
				E	E	E	E	E	E			
3ACP + 24S + 2P		HD								HD		

THIS DRAWING IS A CONTROLLED DOCUMENT.

OWN: R. GRZYBOWSKI 21FEB05  
CHK: M. PERCHERKE 21FEB05  
APVD: M. PERCHERKE

TE Connectivity

NAME: RIGHT ANGLE RECEPTACLE ASSEMBLY WITH GUIDES MULTI-BEAM XL

PRODUCT SPEC: 108-1973  
APPLICATION SPEC: 114-13038

SIZE: A1  
CAGE CODE: 6450170  
DRAWING NO: 100779

RESTRICTED TO: J5

SCALE: 4:1  
SHEET: 6 OF 13  
REV: J5

LOC	DIST	REVISIONS			
P	LTN	DESCRIPTION	DATE	OWN	APVD
ES	00	SEE SHEET 1	-	-	-

PART NUMBER	ROWS	POWER		SIGNAL				POWER		
		P2	P1	4	3	2	1	P1	P2	
2-6450170-0	D C B A	RM	RM	H	H	H	H	RM	RM	RM
				G	G	G	G			
				F	F	F	F			
				E	E	E	E			
IP + 16S + IP										

PART NUMBER	ROWS	POWER		SIGNAL						AC POWER			
		P5	P4	6	5	4	3	2	1	P3	P2	P1	
3-6450170-0	D C B A	RM	RM	H	H	H	H	H	H	RA	RM	RM	RM
				G	G	G	G	G	G				
				F	F	F	F	F	F				
				E	E	E	E	E	E				
3ACP + 24S + 2P													

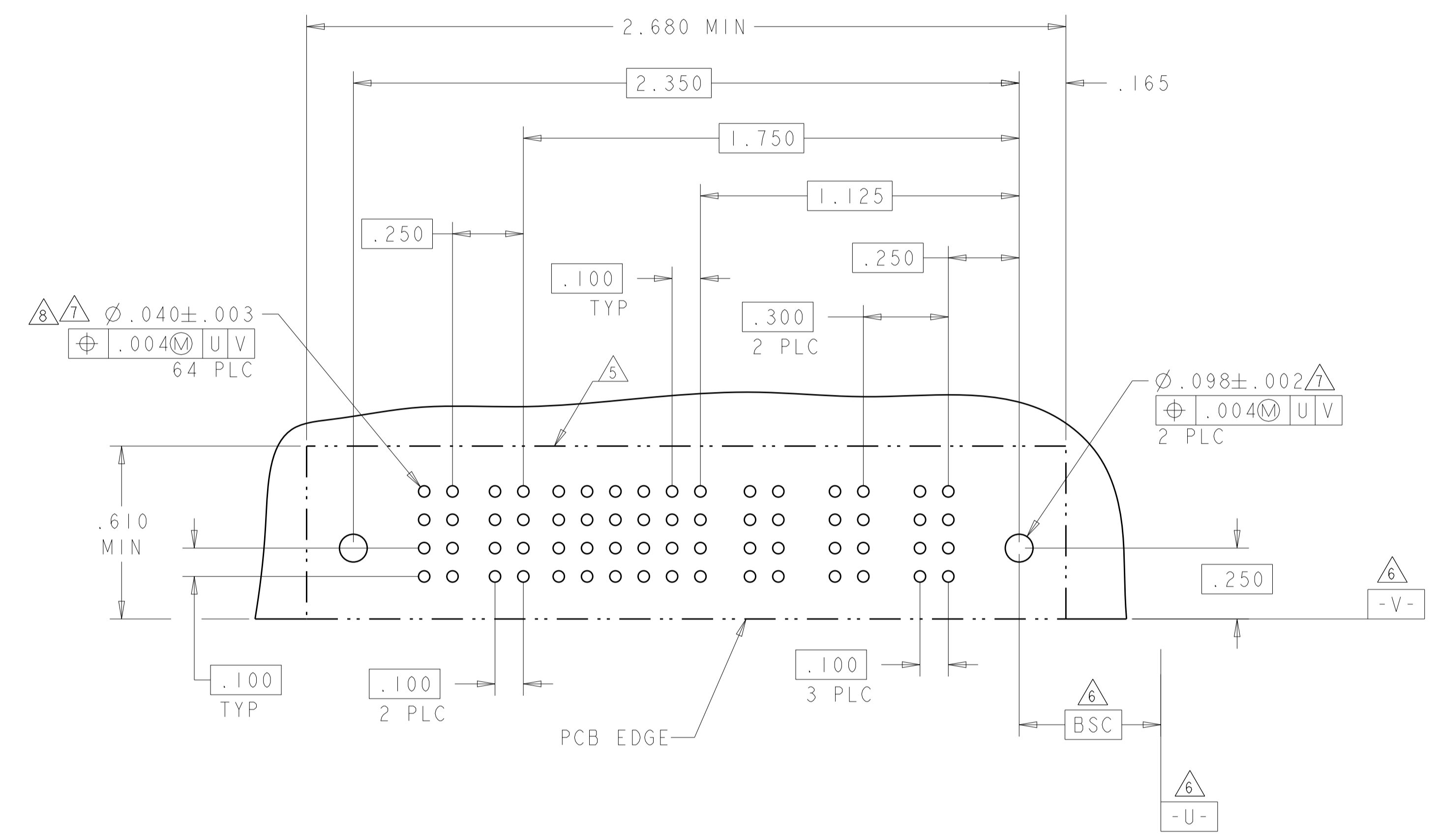
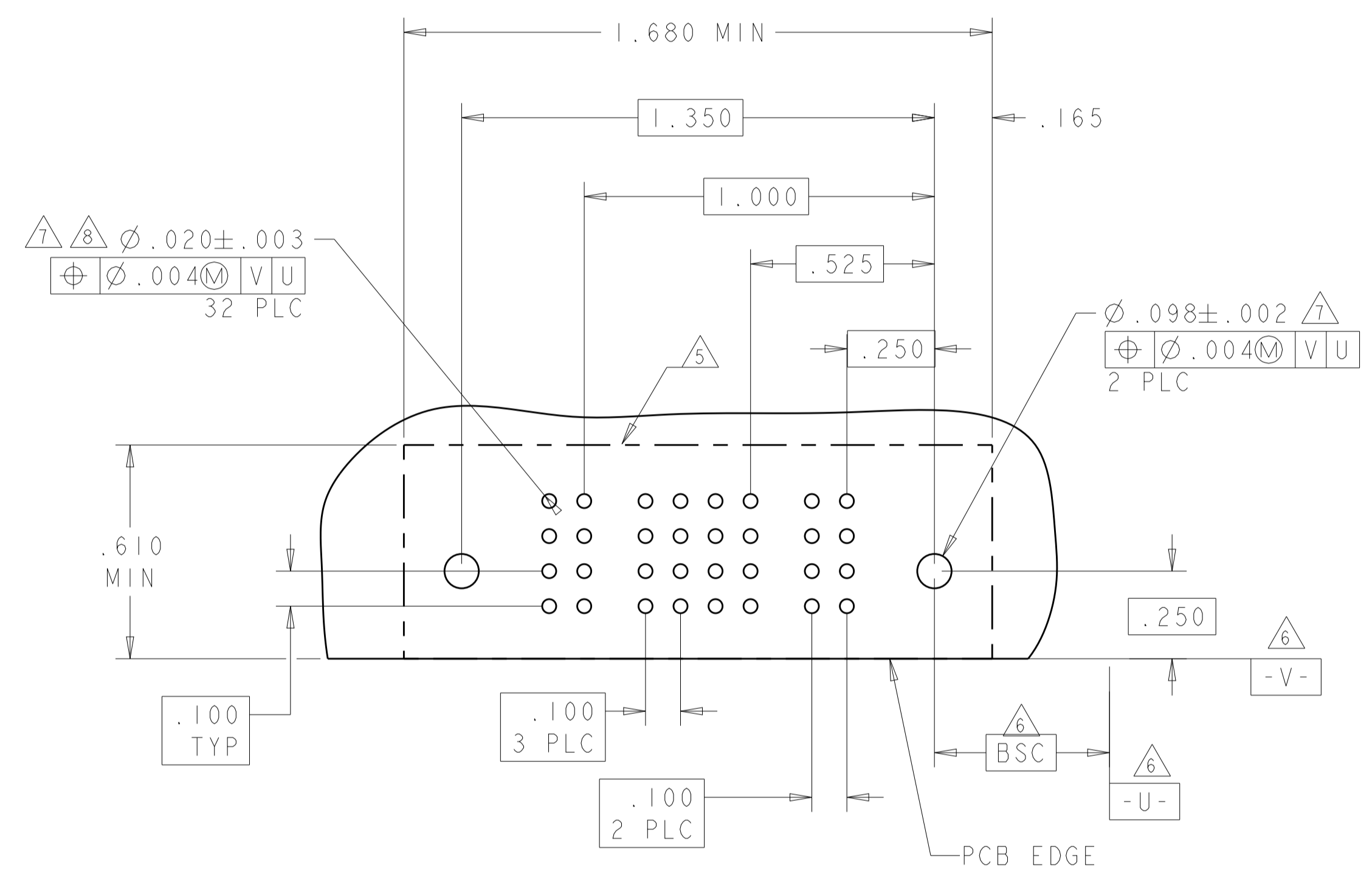

THIS DRAWING IS A CONTROLLED DOCUMENT.		OWN: R. GRZYBOWSKI / ZIFEB05	 TE Connectivity
DIMENSIONS: INCHES		CHK: M. PERCHERKE / ZIFEB05	
TOLERANCES UNLESS OTHERWISE SPECIFIED:		APVD: M. PERCHERKE	NAME: RIGHT ANGLE RECEPTACLE ASSEMBLY WITH GUIDES MULTI-BEAM XL
0 PLC ±. 1 PLC ±.01 2 PLC ±.01 3 PLC ±.005 4 PLC ±.0020 ANGLES ±.2°		PRODUCT SPEC: 108-1973	RESTRICTED TO: -
MATERIAL: -		APPLICATION SPEC: 114-13038	SIZE: A1
FINISH: -		WEIGHT: -	CAGE CODE: 6450170
		CUSTOMER DRAWING	SCALE: 4:1 SHEET 7 OF 13 REV: J5

LOC		DIST		REVISIONS			
ES	00	P	LTN	DESCRIPTION	DATE	DMN	APVD
-	-	-	-	SEE SHEET 1	-	-	-

PART NUMBER	ROWS	POWER		SIGNAL				POWER		HD
		P4	P3	4	3	2	1	P2	P1	
3-6450170-1	D	RM	RA	H	H	H	H	RA	RM	HD
	C			G	G	G	G			
	B			E	E	E	E			
	A			F	F	F	F			
2P + 16S + 2P										

PART NUMBER	ROWS	POWER			SIGNAL						POWER				HD
		P7	P6	P5	6	5	4	3	2	1	P4	P3	P2	P1	
1-6450170-8	D	RM	RM	RA	H	H	H	H	H	H	RM	RM	RM	RM	HD
	C				G	G	G	G	G						
	B				F	F	F	F	F						
	A				E	E	E	E	E						
4P + 24S + 3ACP															

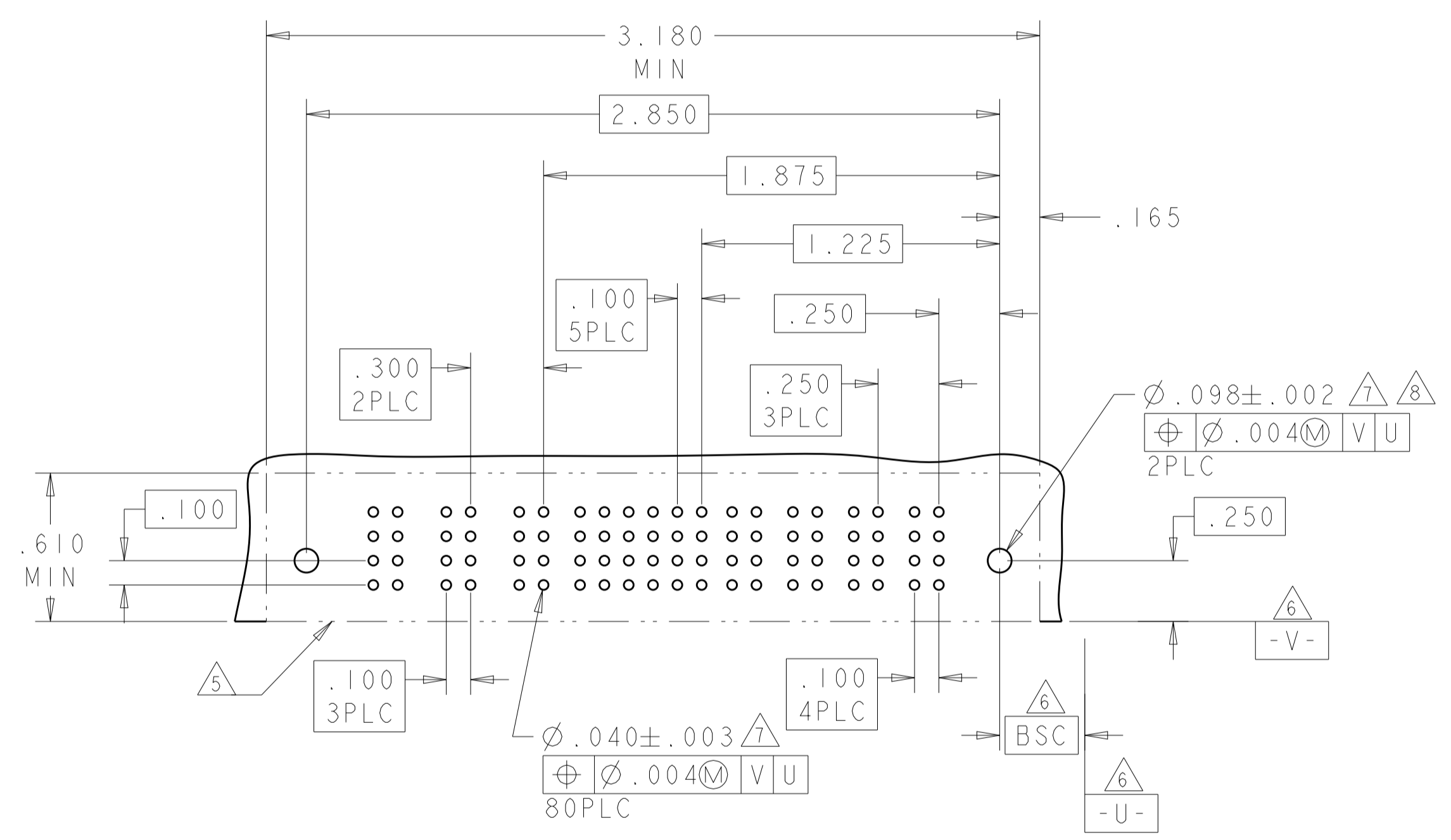
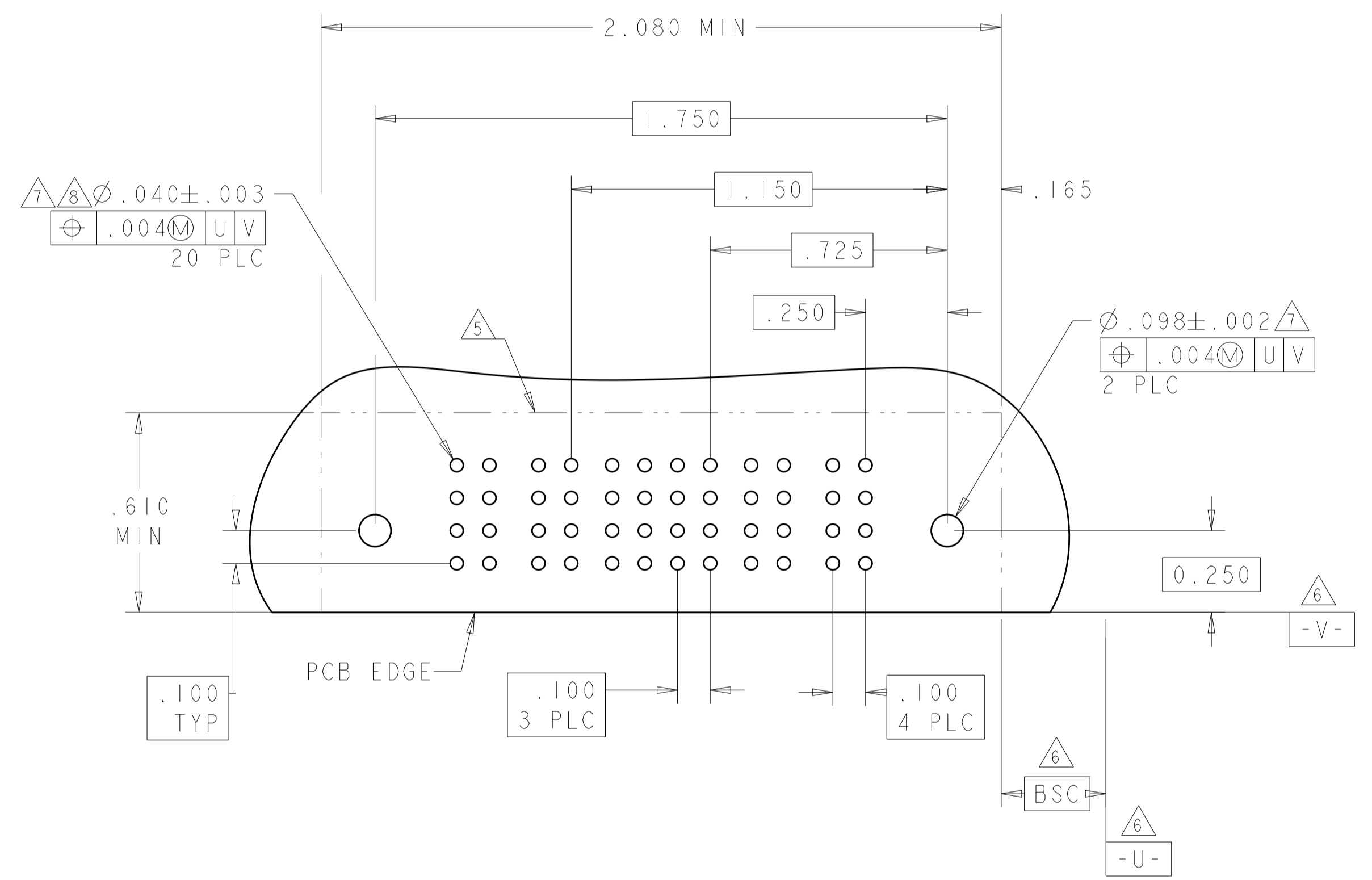

THIS DRAWING IS A CONTROLLED DOCUMENT.		DMN: R. GRZYBOWSKI 21FEB05	 TE Connectivity
DIMENSIONS: INCHES		CHK: M. PERCHERKE	
TOLERANCES UNLESS OTHERWISE SPECIFIED:		APVD: M. PERCHERKE	NAME: RIGHT ANGLE RECEPTACLE ASSEMBLY WITH GUIDES MULTI-BEAM XL
0 PLC ±	1 PLC ±.01	PRODUCT SPEC: 108-1973	SIZE: A100779C=6450170
2 PLC ±.01	3 PLC ±.005	APPLICATION SPEC: 114-13038	RESTRICTED TO: -
4 PLC ±.0020	ANGLES ±.020	WEIGHT: -	SCALE: 4:1
MATERIAL: -	FINISH: -	CUSTOMER DRAWING	SHEET 8 OF 13
		REV: J5	





LOC	DIST	REV	DATE	BY	APPD
ES	00				

REVISIONS					
REV	DATE	BY	APPD	DESCRIPTION	DATE
-	-	-	-	SEE SHEET 1	-

PART NUMBER	ROWS	POWER					SIGNAL			POWER	
		P7	P6	P5	P4	P3	3	2	1	P2	P1
3-6450170-4	D C B A	RM	RM	RM	RM	RM	H	H	H	RM	RM
							G	G	G		
							F	F	F		
							E	E	E		
2P + 12S + 5P											

PART NUMBER	ROWS	POWER		SIGNAL		POWER	
		P4	P3	2	1	P2	P1
3-6450170-5	D C B A	RA	RA	H	H	RM	RM
				G	G		
				F	F		
				E	E		
2P + 8S + 2P							

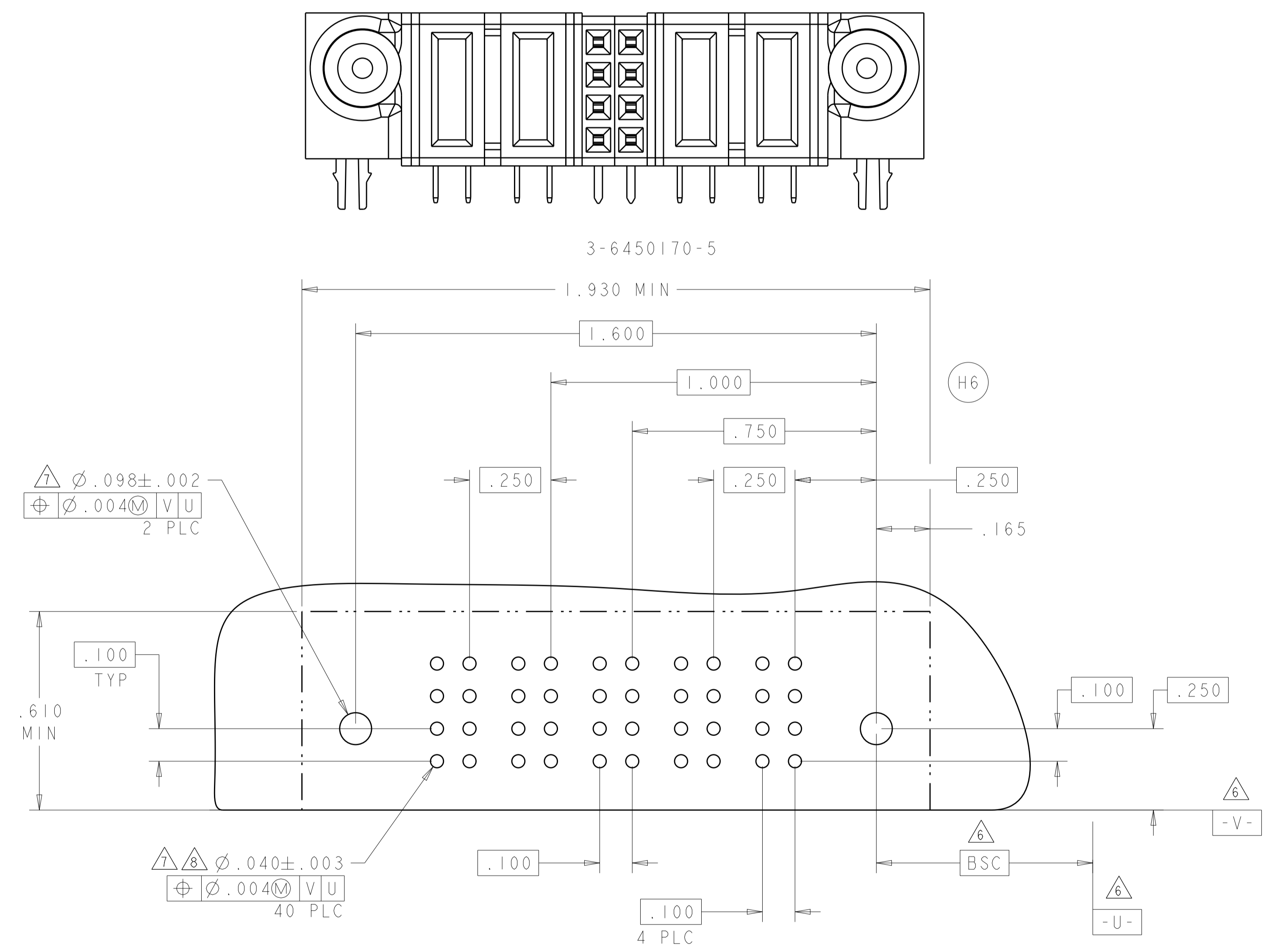
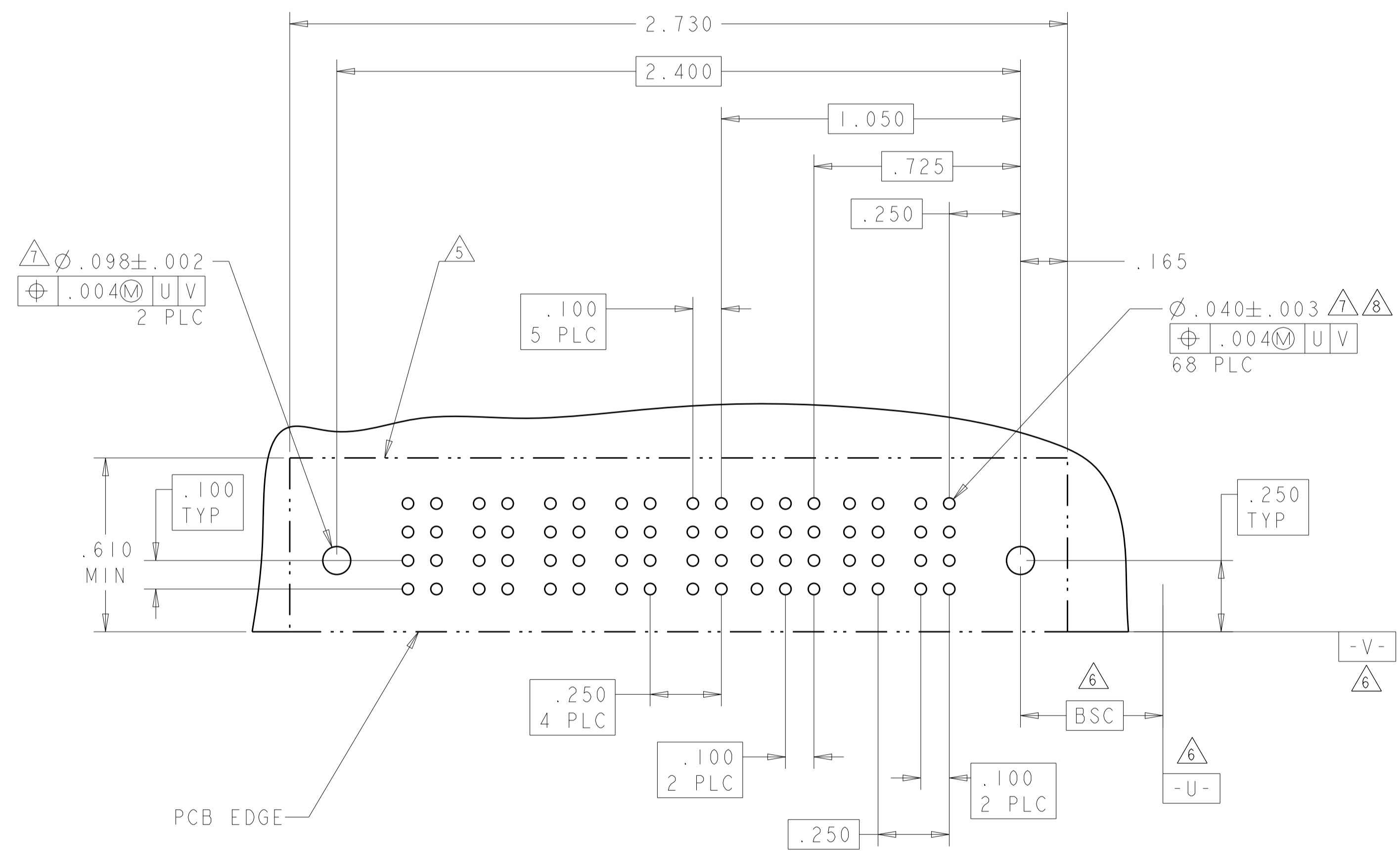

THIS DRAWING IS A CONTROLLED DOCUMENT.		DWN: R. GRZYBOWSKI CHK: M. PERCHERKE	21FEB05	<b>STE</b> TE Connectivity
DIMENSIONS: INCHES		APVD: M. PERCHERKE	NAME: RIGHT ANGLE RECEPTACLE ASSEMBLY WITH GUIDES MULTI-BEAM XL	
TOLERANCES UNLESS OTHERWISE SPECIFIED:		PRODUCT SPEC	108-1973	RESTRICTED TO
0 PLC ± .01		APPLICATION SPEC	114-13038	
1 PLC ± .005		WEIGHT	A100779C=6450170	SCALE: 4:1 SHEET 10 OF 13 REV J5
2 PLC ± .0020		CUSTOMER DRAWING		
ANGLES ± .0020				
FINISH				



LOC	DIST	REV	DATE	BY	APPV
ES	00				
REVISIONS					
DESCRIPTION					
SEE SHEET 1					

PART NUMBER	ROWS	SIGNAL										POWER		
		P2	10	9	8	7	6	5	4	3	2	1	PI	
3-6450170-8	D C B A	H	H	H	H	H	H	H	H	H	H	H	RM	
		G	G	G	G	G	G	G	G	G	G	G	RM	
		F	F	F	F	F	F	F	F	F	F	F	RM	
		E	E	E	E	E	E	E	E	E	E	E	RM	
IP + 40S + IP														

PART NUMBER	ROWS	POWER		SIGNAL		POWER		
		P5	P4	2	1	P3	P2	PI
3-6450170-9	D C B A	RM	RM	H	H	RA	RM	RM
				G	G			
				F	F			
				E	E			
3ACP + 8S + 2P								

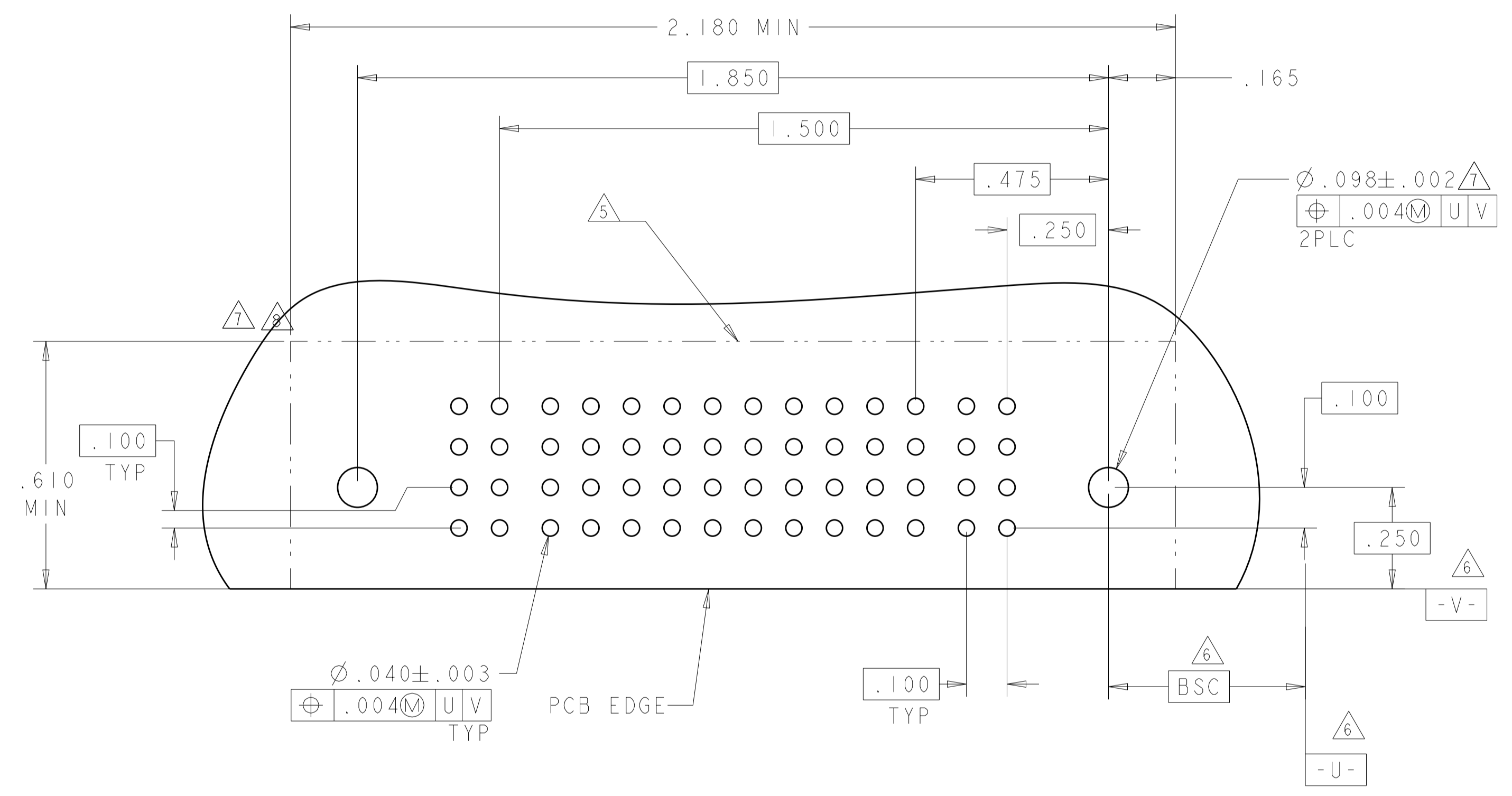

TE RECOMMENDED PCB LAYOUT

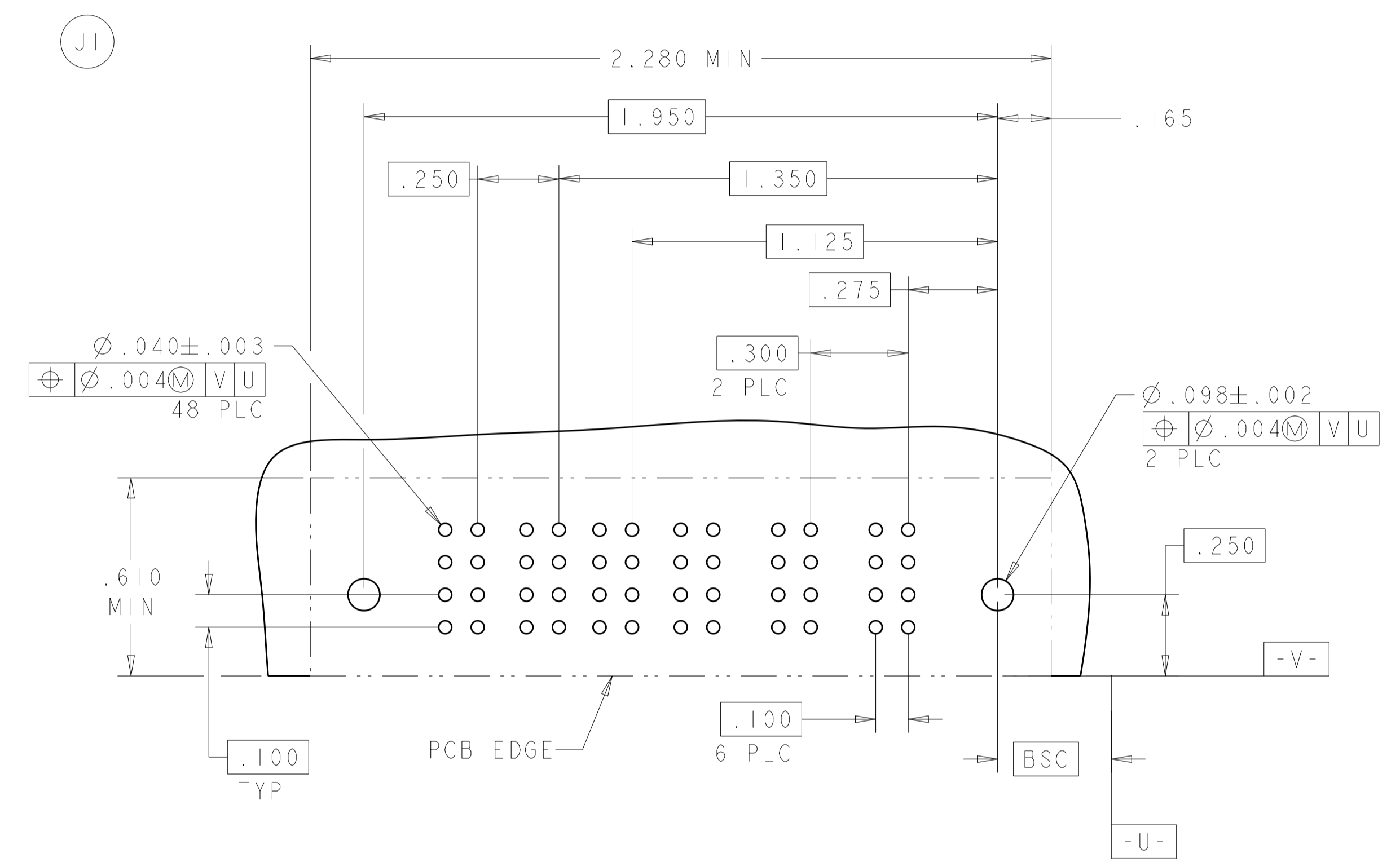

THIS DRAWING IS A CONTROLLED DOCUMENT.		OWN: R. GRZYBOWSKI 21FEB05	 TE Connectivity
DIMENSIONS: INCHES		CHK: M. PERCHERKE 21FEB05	
TOLERANCES UNLESS OTHERWISE SPECIFIED:		APVD: M. PERCHERKE	NAME: RIGHT ANGLE RECEPTACLE ASSEMBLY WITH GUIDES MULTI-BEAM XL
0 PLC ±. 1 PLC ±.01 2 PLC ±.01 3 PLC ±.005 4 PLC ±.0020 ANGLES ±.020		PRODUCT SPEC: 108-1973	SIZE: A1
MATERIAL: FINISH:		APPLICATION SPEC: 114-13038	CAGE CODE: C=6450170
		WEIGHT:	RESTRICTED TO: J5
		CUSTOMER DRAWING	SCALE: 4:1 SHEET 12 OF 13 REV: J5

LOC	DIST	REV	DATE	BY	APPV
ES	00				

REVISIONS		DATE	BY	APPV
1	SEE SHEET 1			

PART NUMBER	ROWS	POWER				SIGNAL			POWER					
		P10	P9	P8	P7	3	2	1	P6	P5	P4	P3	P2	P1
4-6450170-0	D					H	H	H						
	C	RM	RM	RM	RM	G	G	G	RM	RM	RM	RM	RA	RA
	B					F	F	F						
	A	HD				E	E	E						HD

6P + 12S + 4P

PART NUMBER	ROWS	POWER				SIGNAL						POWER			
		P8	P7	P6	P5	P4	P3	6	5	4	3	2	1	P2	P1
4-6450170-1	D					H	H	H	H	H					
	C	RM	RM	RM	RA	G	G	G	G	G	RM	RM			
	B					F	F	F	F	F					
	A	HD				E	E	E	E	E				HD	

2P + 24S + 6P

NO CONTACTS LOADED  
NO CONTACTS LOADED

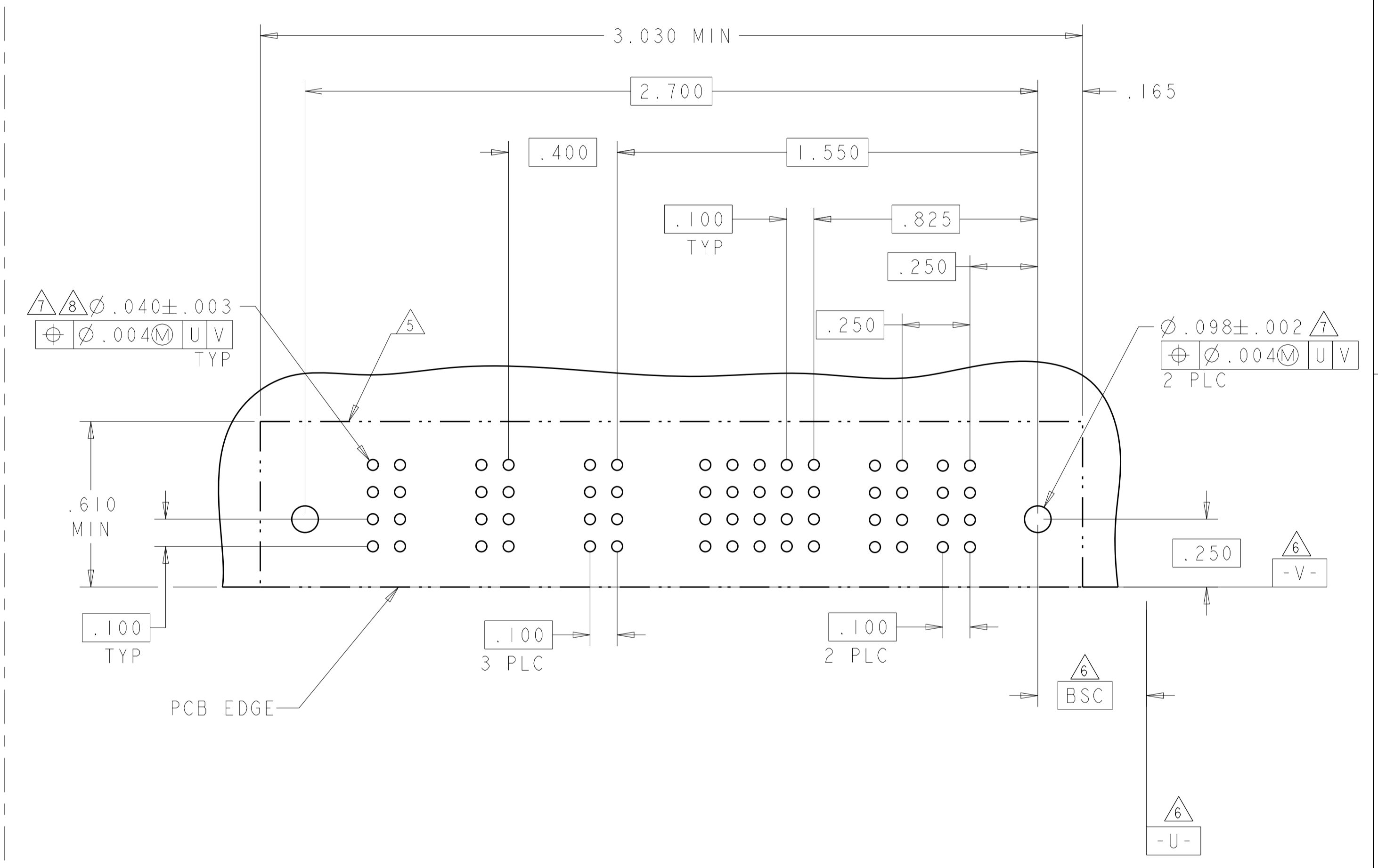
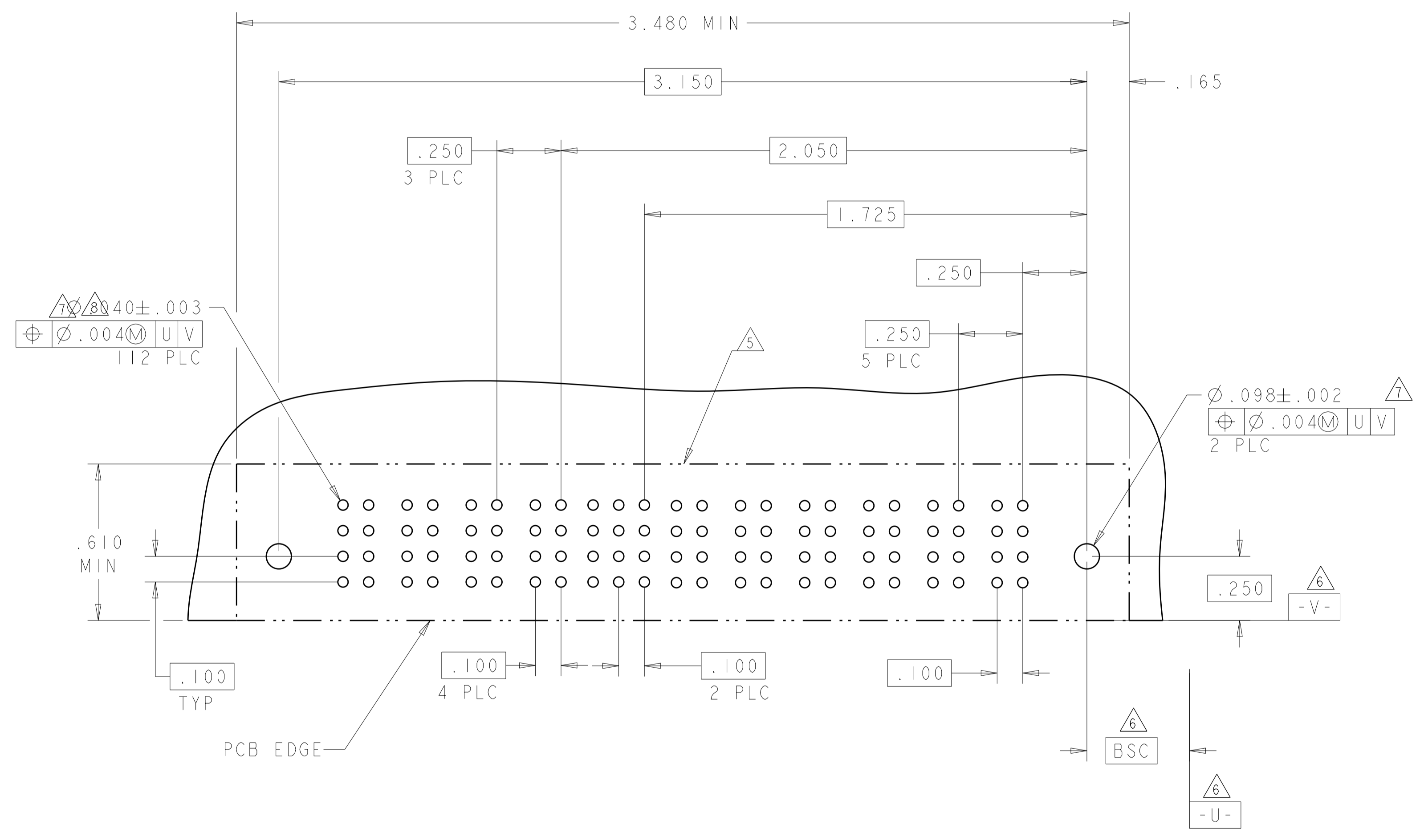

THIS DRAWING IS A CONTROLLED DOCUMENT.		OWN R. GRZYBOWSKI CHK M. PERCHERKE APV M. PERCHERKE	21FEB05 21FEB05	 TE Connectivity
DIMENSIONS: INCHES	TOLERANCES UNLESS OTHERWISE SPECIFIED:	NAME M. PERCHERKE	PRODUCT SPEC 108-1973	
	0 PLC ± 1 PLC ±.01 2 PLC ±.005 3 PLC ±.002 4 PLC ±.002 ANGLES ±.020	APPLICATION SPEC 114-13038	RESTRICTED TO	
MATERIAL	FINISH	WEIGHT	SIZE A100779	DRAWING NO C=6450170
CUSTOMER DRAWING		SCALE 4:1	SHEET 13	OF 13
		REV J5		



Компания «ЭлектроПласт» предлагает заключение долгосрочных отношений при поставках импортных электронных компонентов на взаимовыгодных условиях!

Наши преимущества:

- Оперативные поставки широкого спектра электронных компонентов отечественного и импортного производства напрямую от производителей и с крупнейших мировых складов;
- Поставка более 17-ти миллионов наименований электронных компонентов;
- Поставка сложных, дефицитных, либо снятых с производства позиций;
- Оперативные сроки поставки под заказ (от 5 рабочих дней);
- Экспресс доставка в любую точку России;
- Техническая поддержка проекта, помощь в подборе аналогов, поставка прототипов;
- Система менеджмента качества сертифицирована по Международному стандарту ISO 9001;
- Лицензия ФСБ на осуществление работ с использованием сведений, составляющих государственную тайну;
- Поставка специализированных компонентов (Xilinx, Altera, Analog Devices, Intersil, Interpoint, Microsemi, Aeroflex, Peregrine, Syfer, Eurofarad, Texas Instrument, Miteq, Cobham, E2V, MA-COM, Hittite, Mini-Circuits, General Dynamics и др.);

Помимо этого, одним из направлений компании «ЭлектроПласт» является направление «Источники питания». Мы предлагаем Вам помощь Конструкторского отдела:

- Подбор оптимального решения, техническое обоснование при выборе компонента;
- Подбор аналогов;
- Консультации по применению компонента;
- Поставка образцов и прототипов;
- Техническая поддержка проекта;
- Защита от снятия компонента с производства.



#### Как с нами связаться

**Телефон:** 8 (812) 309 58 32 (многоканальный)

**Факс:** 8 (812) 320-02-42

**Электронная почта:** [org@eplast1.ru](mailto:org@eplast1.ru)

**Адрес:** 198099, г. Санкт-Петербург, ул. Калинина, дом 2, корпус 4, литера А.