

856930

457.5 MHz SAW Filter

Applications

- Smart metering
- Remote meter reading wireless modules
- Licensed band wireless
- General purpose wireless

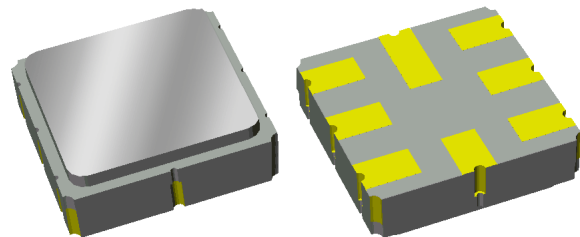

Product Features

- Usable bandwidth 15 MHz
- Low loss
- Dimensions: 3.80 x 3.80 x 1.27 mm
- Single-ended operation
- No impedance matching required for operation at 50Ω
- Matching can be added for high attenuation performance
- Ceramic Surface Mount Package (SMP)
- Industry standard package
- Hermetic **RoHS** compliant, **Pb-free**

General Description

Wireless RF system filter designed specifically for the smart metering infrastructure market.

Low insertion loss, with the option to match for high attenuation, and single ended Input/Output ports make this an effective choice for wireless system designers.

Suitable for use in remote meter reading applications, especially licensed band applications targeting the water metering market.

Functional Block Diagram

Top view

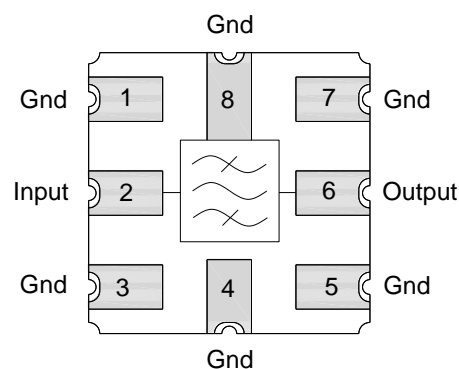

Pin Configuration

Pin #	SE	Description
2		Input
6		Output
1,3,5,7		Ground
4,8		Case Ground

Ordering Information

Part No.	Description
856930	packaged part
856930-EVB	evaluation board

Please specify the unmatched or matched configuration when ordering an evaluation board.

Standard T/R size = 4000 units/reel.

Specifications - Unmatched

Electrical Specifications ⁽¹⁾

Specified Temperature Range: ⁽²⁾ -40 to +85 °C

Parameter ⁽³⁾	Conditions	Min	Typical ⁽⁴⁾	Max	Units
Center Frequency		-	457.5	-	MHz
Maximum Insertion Loss	450 – 465 MHz	-	2.2	3.0	dB
Amplitude Variation ⁽⁵⁾	450 – 465 MHz	-	1.4	2.0	dB p-p
Lower 3.0 dB Bandedge ⁽⁶⁾		-	447.9	450	MHz
Upper 3.0 dB Bandedge ⁽⁶⁾		465	466.9	-	MHz
Upper 25 dB Bandedge ⁽⁶⁾		-	470.2	472	MHz
Upper 34 dB Bandedge ⁽⁶⁾		-	470.5	475	MHz
Absolute Attenuation ⁽⁶⁾	10 – 420 MHz	30	35	-	dB
	472 – 475 MHz	25	70	-	dB
	475 – 480 MHz	34	55	-	dB
	800 – 1000 MHz	30	36	-	dB
Input/Output Return Loss	450 – 465 MHz	-	9	-	dB
Source Impedance (single-ended) ⁽⁷⁾		-	50	-	Ω
Load Impedance (single-ended) ⁽⁷⁾		-	50	-	Ω

Notes:

- All specifications are based on the TriQuint schematic for the main reference design shown on page 4
- In production, devices will be tested at room temperature to a guardbanded specification to ensure electrical compliance over temperature
- Electrical margin has been built into the design to account for the variations due to temperature drift and manufacturing tolerances
- Typical values are based on average measurements at room temperature
- Evaluated as the total variation over the specified band
- Relative to zero dB
- This is the optimum impedance in order to achieve the performance shown

Absolute Maximum Ratings

Parameter	Rating
Operating Temperature	-40 to +85 °C
Storage Temperature	-40 to +85 °C
Input Power ⁽⁸⁾	+20 dBm

8. Input Power is targeted for an applied CW modulated RF signal at 55 °C for 10,000 hours. Operation of this device outside of the parameter ranges listed above may cause permanent damage.

Specifications - Matched

Electrical Specifications ⁽¹⁾

Specified Temperature Range: ⁽²⁾ -40 to +85 °C

Parameter ⁽³⁾	Conditions	Min	Typical ⁽⁴⁾	Max	Units
Center Frequency		-	457.5	-	MHz
Maximum Insertion Loss	450 – 465 MHz	-	2.9	3.5	dB
Amplitude Variation ⁽⁵⁾	450 – 465 MHz	-	1.4	2.2	dB p-p
Lower 3.5 dB Bandedge ⁽⁶⁾		-	448.33	450	MHz
Upper 3.5 dB Bandedge ⁽⁶⁾		465	466.93	-	MHz
Upper 25 dB Bandedge ⁽⁶⁾		-	470.5	472.4	MHz
Upper 34 dB Bandedge ⁽⁶⁾		-	470.81	475	MHz
Absolute Attenuation ⁽⁶⁾	10 – 300 MHz	50	53	-	dB
	300 – 420 MHz	25	32	-	dB
	472.4 – 475MHz	25	65	-	
	475 – 480 MHz	34	62	-	dB
	480 – 1000 MHz	30	39	-	dB
Input/Output Return Loss	450 – 465 MHz	-	9	-	dB
Source Impedance (single-ended) ⁽⁷⁾		-	50	-	Ω
Load Impedance (single-ended) ⁽⁷⁾		-	50	-	Ω

Notes:

- All specifications are based on the TriQuint schematic for the main reference design shown on page 6
- In production, devices will be tested at room temperature to a guardbanded specification to ensure electrical compliance over temperature
- Electrical margin has been built into the design to account for the variations due to temperature drift and manufacturing tolerances
- Typical values are based on average measurements at room temperature
- Evaluated as the total variation over the specified band
- Relative to zero dB
- This is the optimum impedance in order to achieve the performance shown

Absolute Maximum Ratings

Parameter	Rating
Operating Temperature	-40 to +85 °C
Storage Temperature	-40 to +85 °C
Input Power ⁽⁸⁾	+20 dBm

- Input Power is targeted for an applied CW modulated RF signal at 55 °C for 10,000 hours. Operation of this device outside the parameter ranges given above may cause permanent damage.

856930

457.5 MHz SAW Filter

Reference – Unmatched

Schematic

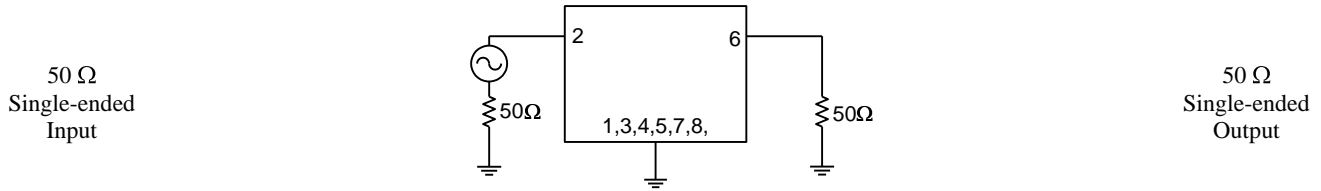

Notes:

1. No impedance matching required
2. Actual matching values may vary due to PCB layout and parasitic

PC Board

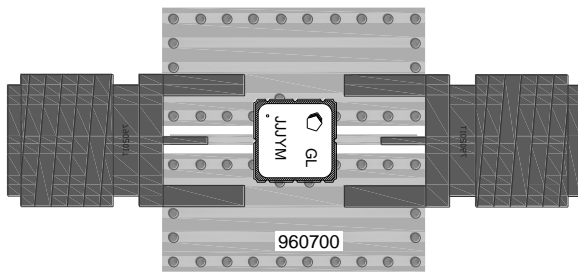

Notes:

- Top, middle & bottom layers: 1 oz copper
- Substrates: FR4 dielectric, .031" thick
- Finish plating: Nickel: 3-8 μ m thick, Gold: .03-.2 μ m thick
- Hole plating: Copper min .0008 μ m thick

Mounting Configuration

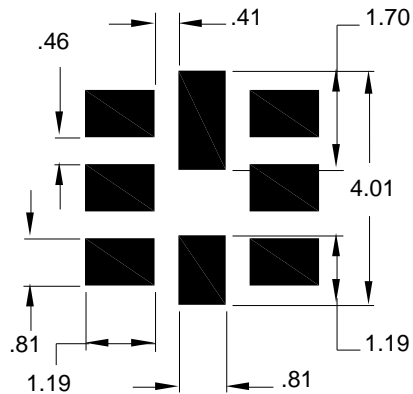

Notes:

1. All dimensions are in millimeters.
2. This footprint represents a recommendation only.

Bill of Material

Reference Desg.	Value	Description	Manufacturer	Part Number
SMA	N/A	SMA connector	Radiall USA Inc.	9602-1111-018
PCB	N/A	3-layer	multiple	960700

Typical Performance - Unmatched (at room temperature)

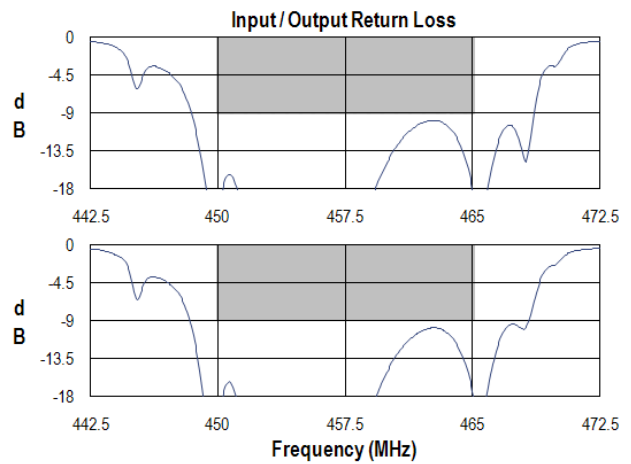
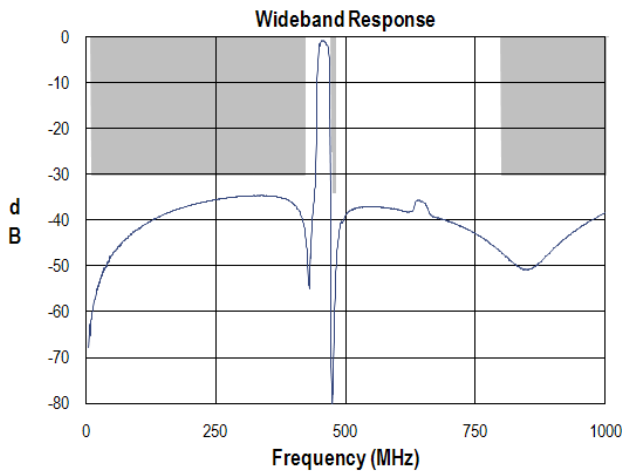
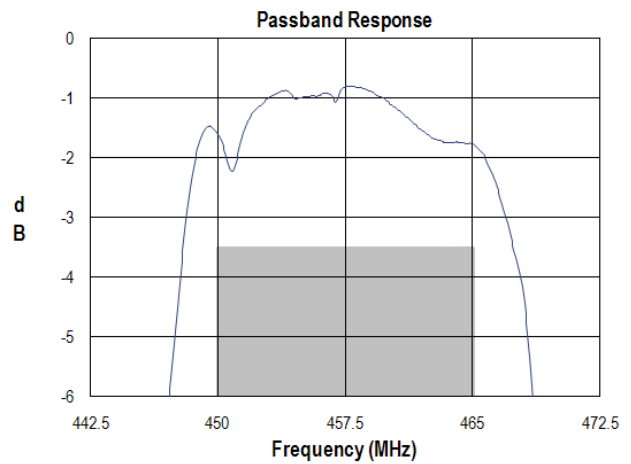
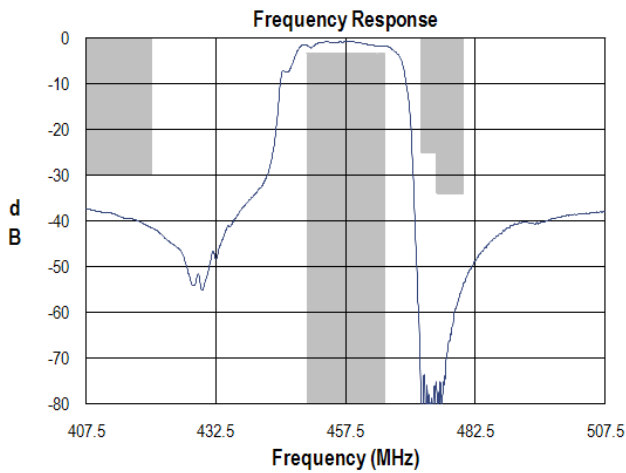

Input Smith Chart

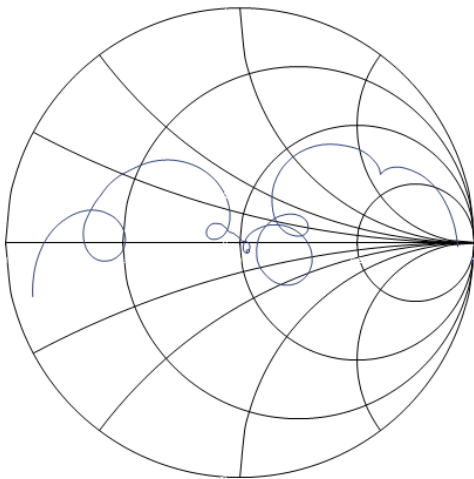

Output Smith Chart

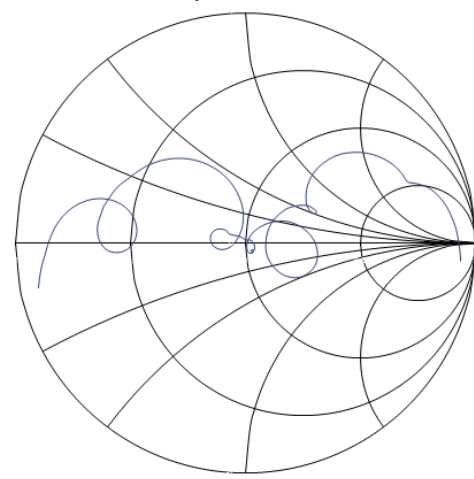

856930

457.5 MHz SAW Filter

Reference – Matched

Schematic

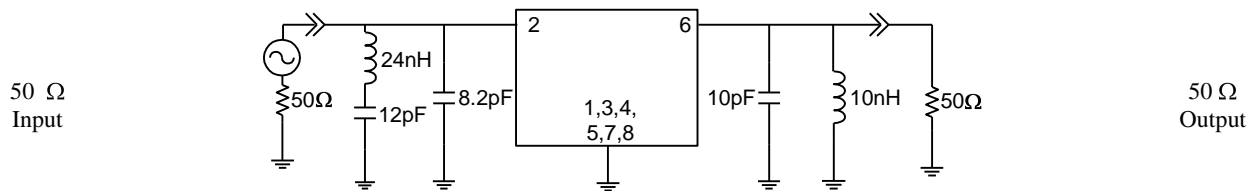

Notes:

Actual matching values may vary due to PCB layout and parasitic

PC Board

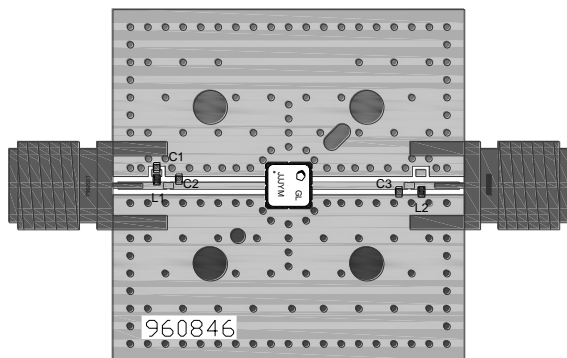

Notes:

3-layer board - top, middle & bottom layer: 1 oz copper
 Substrates: .031" thick FR4 dielectric.
 Finish plating: Nickel: 3-8µm thick, Gold: .03-.2µm thick
 Hole plating: Copper min .0008µm thick

Mounting Configuration

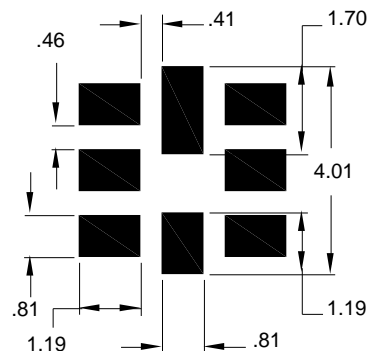

Notes:

1. All dimensions are in millimeters.
2. This footprint represents a recommendation only.

Bill of Material

Reference Desg.	Value	Description	Manufacturer	Part Number
L1	24nH	Coil Wire-wound, 0402	MuRata	LQW15AN24NJ00
L2	10nH	Coil Wire-wound, 0402	MuRata	LQW15AN10NJ00
C1	12pF	Chip Ceramic, 0402	MuRata	GRM1555C1H120GZ01
C2	8.2pF	Chip Ceramic, 0402	MuRata	GRM1555C1H8R2FZ01
C3	10pF	Chip Ceramic, 0402	MuRata	GRM1555C1H100KZ01
SMA	N/A	SMA connector	Radiall USA Inc.	9602-1111-018
PCB	N/A	3-layer	multiple	960846

Typical Performance - Matched (at room temperature)

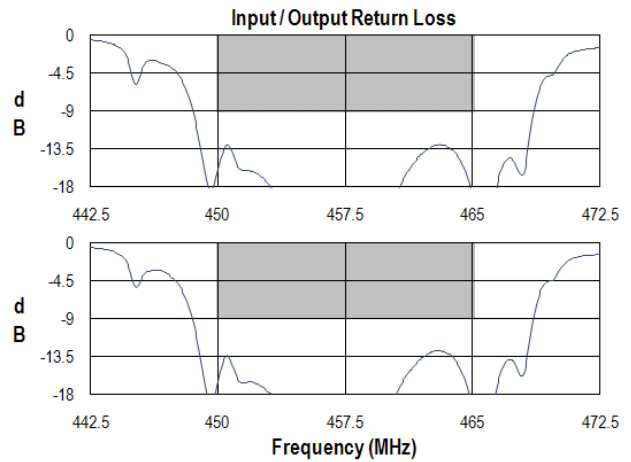
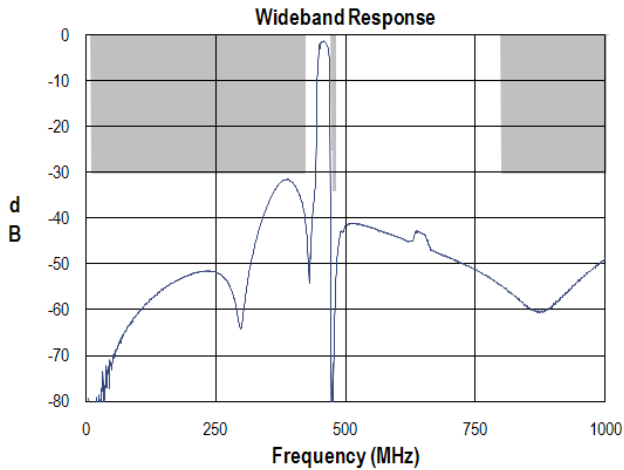
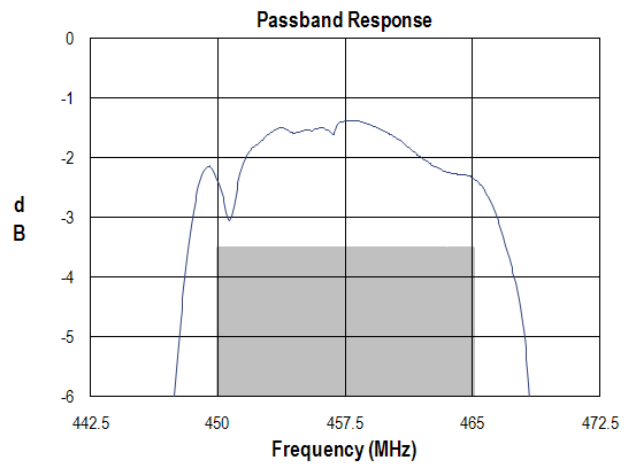
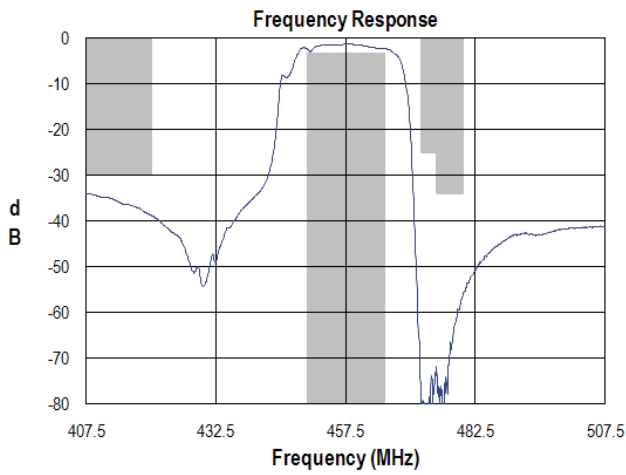

Input Smith Chart

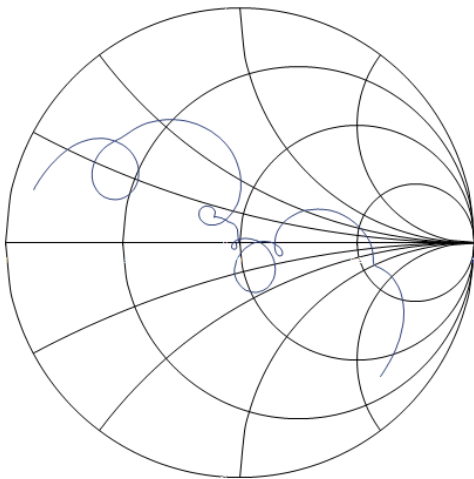

Output Smith Chart

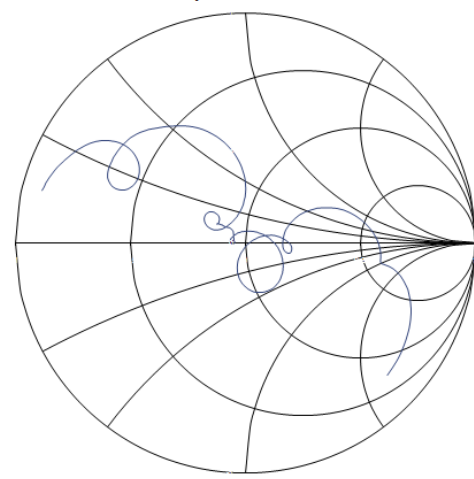

Product Compliance Information

ESD Information



Caution! ESD-Sensitive Device

ESD Rating: 1B

Value: Passes ≥ 800 V min.
 Test: Human Body Model (HBM)
 Standard: JEDEC Standard JESD22-A114

ESD Rating: B

Value: Passes ≥ 300 V min.
 Test: Machine Model (MM)
 Standard: JEDEC Standard JESD22-A115

MSL Rating

Devices are Hermetic, therefore MSL is not applicable

Solderability

Compatible with the latest version of J-STD-020, lead free solder, 260°C

Refer to [Soldering Profile](#) for recommended guidelines.

This part is compliant with EU 2002/95/EC RoHS directive (Restrictions on the Use of Certain Hazardous Substances in Electrical and Electronic Equipment).

This product also has the following attributes:

- Halogen Free (Chlorine, Bromine)
- Antimony Free
- TBBP-A (C₁₅H₁₂Br₄O₂) Free
- PFOS Free
- SVHC Free

Contact Information

For the latest specifications, additional product information, worldwide sales and distribution locations, and information about TriQuint:

Web: www.triquint.com
 Email: info-sales@tqs.com

Tel: +1.407.886.8860
 Fax: +1.407.886.7061

For technical questions and application information:

Email: flapplication.engineering@tqs.com

Important Notice

The information contained herein is believed to be reliable. TriQuint makes no warranties regarding the information contained herein. TriQuint assumes no responsibility or liability whatsoever for any of the information contained herein. TriQuint assumes no responsibility or liability whatsoever for the use of the information contained herein. The information contained herein is provided "AS IS, WHERE IS" and with all faults, and the entire risk associated with such information is entirely with the user. All information contained herein is subject to change without notice. Customers should obtain and verify the latest relevant information before placing orders for TriQuint products. The information contained herein or any use of such information does not grant, explicitly or implicitly, to any party any patent rights, licenses, or any other intellectual property rights, whether with regard to such information itself or anything described by such information.

TriQuint products are not warranted or authorized for use as critical components in medical, life-saving, or life-sustaining applications, or other applications where a failure would reasonably be expected to cause severe personal injury or death.



Компания «ЭлектроПласт» предлагает заключение долгосрочных отношений при поставках импортных электронных компонентов на взаимовыгодных условиях!

Наши преимущества:

- Оперативные поставки широкого спектра электронных компонентов отечественного и импортного производства напрямую от производителей и с крупнейших мировых складов;
- Поставка более 17-ти миллионов наименований электронных компонентов;
- Поставка сложных, дефицитных, либо снятых с производства позиций;
- Оперативные сроки поставки под заказ (от 5 рабочих дней);
- Экспресс доставка в любую точку России;
- Техническая поддержка проекта, помощь в подборе аналогов, поставка прототипов;
- Система менеджмента качества сертифицирована по Международному стандарту ISO 9001;
- Лицензия ФСБ на осуществление работ с использованием сведений, составляющих государственную тайну;
- Поставка специализированных компонентов (Xilinx, Altera, Analog Devices, Intersil, Interpoint, Microsemi, Aeroflex, Peregrine, Syfer, Eurofarad, Texas Instrument, Miteq, Cobham, E2V, MA-COM, Hittite, Mini-Circuits, General Dynamics и др.);

Помимо этого, одним из направлений компании «ЭлектроПласт» является направление «Источники питания». Мы предлагаем Вам помощь Конструкторского отдела:

- Подбор оптимального решения, техническое обоснование при выборе компонента;
- Подбор аналогов;
- Консультации по применению компонента;
- Поставка образцов и прототипов;
- Техническая поддержка проекта;
- Защита от снятия компонента с производства.



Как с нами связаться

Телефон: 8 (812) 309 58 32 (многоканальный)

Факс: 8 (812) 320-02-42

Электронная почта: org@eplast1.ru

Адрес: 198099, г. Санкт-Петербург, ул. Калинина, дом 2, корпус 4, литера А.