

A Brand New Lineup of A7C Series Compact Thumbwheel Switches

- The series includes a complete range of locking-type models that prevent accidental operation.



Ordering Information

Switches (Single Switch Units)

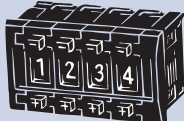
| Model | | A7CN | | | |
|------------------------------|-----------------|--|------------|--|------------|
| Classification (See note 1.) | | Screw mounting (back mounting) | | Snap-in (front mounting) | |
| | |  | |  | |
| Output code number | Terminals Color | PCB terminals | | | |
| | | Light gray | Black | Light gray | Black |
| 06 (binary coded decimal) | | — | A7CN-106-1 | A7CN-206 | A7CN-206-1 |

| Model | | A7CN-L | |
|------------------------------|-----------------|--|-------------|
| Classification (See note 1.) | | Snap-in (front mounting) | |
| | |  | |
| | | Locking type | |
| Output code number | Terminals Color | PCB terminals | |
| | | Light gray | Black |
| 06 (binary coded decimal) | | A7CN-L206 | A7CN-L206-1 |

- Note: 1. The classification diagrams show 4 Switch Units combined with End Caps to create 4-digit displays.
 2. The model numbers given above are for Switch Units.
 3. Models with +, - displays can also be produced. Add "-PM" after the "206" in the model number (e.g., A7CN-206-PM or A7CN-206-PM-1).

Accessories (Order Separately)

Use accessories, such as End Caps and Spacers, with the Switch Units.

| Classification | | Screw mounting (back mounting) | Snap-in (front mounting) | |
|-------------------|-------|--------------------------------|--------------------------|------------------------|
| Accessory | Color | Black | Light gray | Black |
| End Caps (1 pair) | | A7CN-1M-1 * | A7CN-2M * | A7CN-2M-1 * |
| Spacer | | A7CN-1P□-1 (See note.) | A7CN-2P□ (See note.) | A7CN-2P□-1 (See note.) |

- Note: The □ in the Spacer model number stands for a letter in the range A to U. (Refer to the table in the following explanation about Spacers.)
 * The minimum order is for 10 End Caps.

End Caps

End Caps are used on the Switch Units at each end and allow all the Switch Units to be securely mounted to a panel. They come in pairs, one for the left and one for the right.

Spacers

- Spacers are used for creating extra space or gaps between the Switch Units and have the same dimensions as the Switch Units themselves.
- There are also Spacers with engraved characters or symbols that can be used for indicating units, such as time and length. (Refer to the following table.) Consult your OMRON representative for details.

| Symbol | A | B | C | D | E | F | G |
|--------|----------------|-----|-----|---|---|----|----|
| Stamp | No designation | SEC | MIN | H | g | kg | mm |

| Symbol | H | J | K | L | Q | T | U |
|--------|----|---|----|-----|------------|---|---|
| Stamp | cm | m | °C | PCS | x10 SEC | 0 | • |

Specifications

| | | |
|--|---|--|
| Switching capacity (resistive load) | | 5 to 28 VDC 1 mA to 0.1 A |
| Continuous carry current | | 1A |
| Contact resistance | | 200 mΩ max. |
| Insulation resistance | Between non-connected terminals | 10 MΩ min. (at 250 VDC) |
| | Between terminal and non-current carrying part | 100 MΩ min. (at 500 VDC) |
| Dielectric strength | Between non-connected terminals | 200 VAC, 50/60 Hz for 1 min |
| | Between terminal and non-current carrying part | 1,000 VAC, 50/60 Hz for 1 min |
| Vibration resistance | | 10 to 55 Hz, 1.5-mm double amplitude |
| Shock resistance | | 490m/s ² min. |
| Durability | Mechanical | 30,000 operations min. |
| | Electrical | 20,000 operations min. |
| Ambient temperature | | Operating: -10°C to 65°C (with no icing) Storage: -20°C to 80°C |
| Ambient humidity | | Operating: 35% to 85% |
| Max. operating force | | 4.41 N max. |

Dimensions

Switches

A7CN-106-1 PCB Terminals

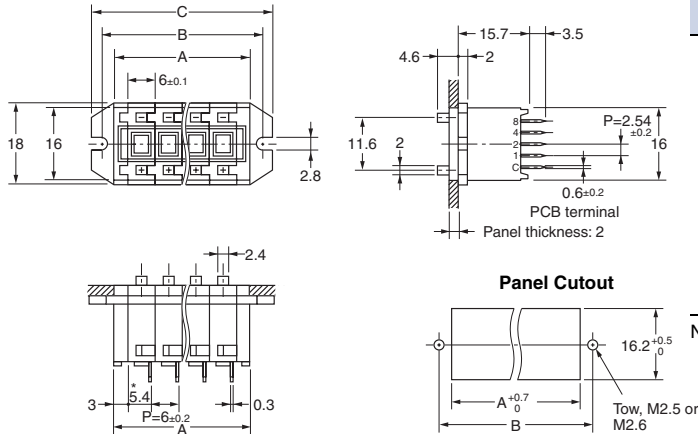
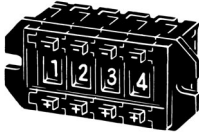

* Terminal position dimensions

Note: Common terminal C is at the bottom when the Switch Unit is viewed from the front.

| Number of Switches (n) | Size A (n x 6 + 6) | Size B (n x 6 + 11) | Size C (n x 6 + 16) |
|------------------------|--------------------|---------------------|---------------------|
| 1 | 12 | 17 | 22 |
| 2 | 18 | 23 | 28 |
| 3 | 24 | 29 | 34 |
| 4 | 30 | 35 | 40 |
| 5 | 36 | 41 | 46 |
| 6 | 42 | 47 | 52 |
| 7 | 48 | 53 | 58 |
| 8 | 54 | 59 | 64 |
| 9 | 60 | 65 | 70 |
| 10 | 66 | 71 | 76 |

Note: 1. The dimensions above include both End Caps, and will increase 6 mm for each Spacer inserted.
2. Unless otherwise specified, a tolerance of ±0.4 mm applies to all dimensions. The tolerance for multiple connection is ±(number of units x 0.4) mm.

A7CN-206(-1) PCB Terminals

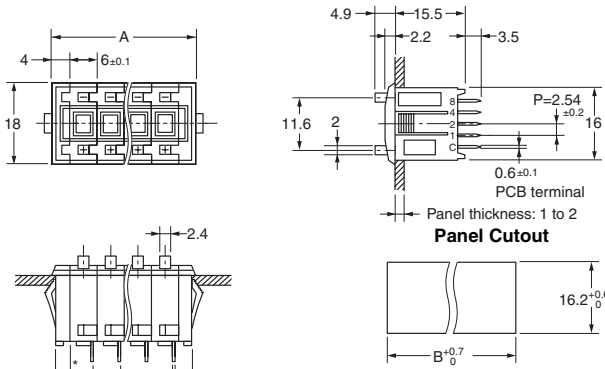
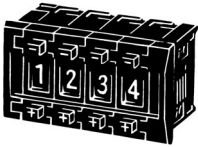

* Terminal position dimensions

Note: Common terminal C is at the bottom when the Switch Unit is viewed from the front.

| Number of Switches (n) | Size A (n x 6 + 8) | Size B (n x 6 + 6) |
|------------------------|--------------------|--------------------|
| 1 | 14 | 12 |
| 2 | 20 | 18 |
| 3 | 26 | 24 |
| 4 | 32 | 30 |
| 5 | 38 | 36 |
| 6 | 44 | 42 |
| 7 | 50 | 48 |
| 8 | 56 | 54 |
| 9 | 62 | 60 |
| 10 | 68 | 66 |

Note: 1. The dimensions above include both End Caps, and will increase 6 mm for each Spacer inserted.
2. Unless otherwise specified, a tolerance of ±0.4 mm applies to all dimensions. The tolerance for multiple connection is ±(number of units x 0.4) mm.

A7CN-L206(-1) PCB Terminals Locking Model

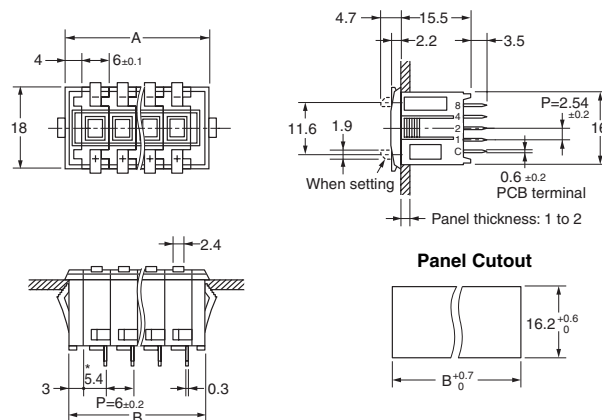

* Terminal position dimensions

Note: Common terminal C is at the bottom when the Switch Unit is viewed from the front.

| Number of Switches (n) | Size A (n x 6 + 8) | Size B (n x 6 + 6) |
|------------------------|--------------------|--------------------|
| 1 | 14 | 12 |
| 2 | 20 | 18 |
| 3 | 26 | 24 |
| 4 | 32 | 30 |
| 5 | 38 | 36 |
| 6 | 44 | 42 |
| 7 | 50 | 48 |
| 8 | 56 | 54 |
| 9 | 62 | 60 |
| 10 | 68 | 66 |

Note: 1. The dimensions above include both End Caps, and will increase 6 mm for each Spacer inserted.
2. Unless otherwise specified, a tolerance of ±0.4 mm applies to all dimensions. The tolerance for multiple connection is ±(number of units x 0.4) mm.

Accessories (Order Separately)

End Caps for Push-operated Switches A7CN-1M-1 Screw Mounting

Left Side

Right Side



End Caps for Push-operated Switches A7CN-2M(-1) Snap-in Mounting

Left Side

Right Side

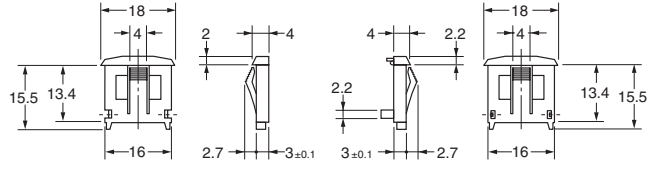

Spacers for Push-operated Switches A7CN-1P□-1

Screw Panel Mounting Model

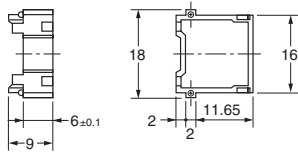

Note: The □ in the Spacer model number stands for a letter in the range A to U. (Refer to the table under the explanation about Spacers on page 3.)

Spacers for Push-operated Switches A7CN-2P□(-1)

Snap-in Mounting Model



Note: The □ in the Spacer model number stands for a letter in the range A to U. (Refer to the table under the explanation about Spacers on page 3.)

Note: Unless otherwise indicated, dimensional tolerances for dimensions in the models above are ± 0.4 mm.

Output Codes

06 (Binary Code)

| Dial | Terminals connected to common | | | |
|------|-------------------------------|---|---|---|
| | 1 | 2 | 4 | 8 |
| 0 | | | | |
| 1 | ● | | | |
| 2 | | ● | | |
| 3 | ● | ● | | |
| 4 | | | ● | |
| 5 | ● | | ● | |
| 6 | | ● | ● | |
| 7 | ● | ● | ● | |
| 8 | | | | ● |
| 9 | ● | | | ● |

Note: The solid dot ● indicates that the internal switch is ON (i.e., connected to the common terminal).

Ordering Procedure

Place orders as shown in the example below, specifying the model and number. Standard products are not factory-assembled for shipment. Contact your OMRON representative for details on ordering factory-assembled sets.

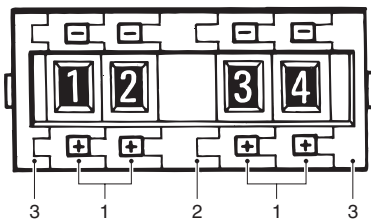

1. Switch Unit (snap-in mounting, black)
A7CN-206-1: 4 pieces
2. Spacer (snap-in mounting, no designation, black)
A7CN-2PA-1: 1 piece
3. End Caps (snap-in mounting, black)
A7CN-2M-1: 1 pair

Safety Precautions

Refer to *Precautions for Correct Use* on in the *Technical Guide for Thumbwheel Switches*.

Precautions for Correct Use

Environment

- Do not use where gases are generated (ammonia, chlorine, sulfur dioxide).
- Although Switches are of nearly dust-proof construction, they are not drip-proof, therefore do not use in areas subject to water or oil exposure and do not operate with wet or oily hands.
- Provide additional dust-proofing measures, such as using a dust-proof cover, when using in sand-exposed areas.

Handling

- The A7CN cannot be connected to the A7C.
- The molded components of the Switch use polyacetal resin and polycarbonate resin. It is recommended that alcohol is used to wipe off dirt and smudges from the molded components. Take care to prevent the alcohol from getting inside. Do not use thinner or other solutions which might damage the resin.
- When changing settings, do not touch the operating buttons if your fingers are wet or there is oil or any other foreign substance on your fingers.
- Do not drop the individual Switches. Doing so may damage the resin catch (for connecting) on the side of the Switch.
- When separating Switches, use a screwdriver as shown in the figure below; disconnect them by releasing the top and bottom hooks. Be careful not to bend the hooks.



- When connecting Switches, fit the mating parts together.
- Do not push the (+) and (-) operating push-buttons at the same time.

Models with PCB Terminals

Do not use excessive force in handling the Switches. In particular, take care to avoid dropping them because the terminals might bend or break.

Screw-mounting Models

Tighten mounting screws to a torque between 0.2 to 0.24 N·m, using M2.6 screws. Use plain washers or spring washers together with the screws.

Setting Numbers

Locking Type

- Set with the setting button by raising it.
- Return the button to its original position after setting. It is then locked to prevent rotation, and the set numbers will not change accidentally.

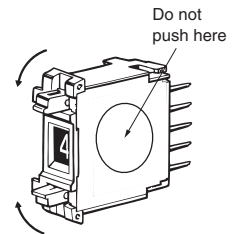

Soldering

Note the following points when soldering printed circuit boards:

- The terminal insertion holes on the PCB must be at least 1 mm in diameter.
- Automatic Soldering
Do not use dip cleaning. Doing so may result in flux penetration of the Switch interior, causing contact and rotational defects. Clean the flux as shown in Figure 1, tilting the Switch 80° or less and using a brush to apply the solvent only to the back of the board. It may also be cleaned by dipping only the back of the board into the solvent and then using a brush to clean.
- Dip Soldering
When applying flux solvent, the dipping time is a maximum of 2 seconds. As shown in Figure 2, avoid flooding the top surface of the printed circuit board with flux. Using a brush to apply flux further reduces the danger of flux penetration. When cleaning flux with a brush, tilt the Switch 80° or less, as shown in Figure 1, in order to prevent flux from flowing onto the switch mounting surface. Clean flux as described above under Automatic Soldering.



- Using a Soldering Iron
Use a 30-W soldering iron at a temperature of 350°C for a maximum of 3 seconds, and flush as described above. Do not apply force to the terminals during soldering and for 3 minutes after soldering is completed. Doing so may result in conduction or operation failure.
- Ensure that soldering flux and alcohol do not penetrate into the Switch interior

Read and Understand This Catalog

Please read and understand this catalog before purchasing the products. Please consult your OMRON representative if you have any questions or comments.

Warranty and Limitations of Liability

WARRANTY

OMRON's exclusive warranty is that the products are free from defects in materials and workmanship for a period of one year (or other period if specified) from date of sale by OMRON.

OMRON MAKES NO WARRANTY OR REPRESENTATION, EXPRESS OR IMPLIED, REGARDING NON-INFRINGEMENT, MERCHANTABILITY, OR FITNESS FOR PARTICULAR PURPOSE OF THE PRODUCTS. ANY BUYER OR USER ACKNOWLEDGES THAT THE BUYER OR USER ALONE HAS DETERMINED THAT THE PRODUCTS WILL SUITABLY MEET THE REQUIREMENTS OF THEIR INTENDED USE. OMRON DISCLAIMS ALL OTHER WARRANTIES, EXPRESS OR IMPLIED.

LIMITATIONS OF LIABILITY

OMRON SHALL NOT BE RESPONSIBLE FOR SPECIAL, INDIRECT, OR CONSEQUENTIAL DAMAGES, LOSS OF PROFITS OR COMMERCIAL LOSS IN ANY WAY CONNECTED WITH THE PRODUCTS, WHETHER SUCH CLAIM IS BASED ON CONTRACT, WARRANTY, NEGLIGENCE, OR STRICT LIABILITY.

In no event shall the responsibility of OMRON for any act exceed the individual price of the product on which liability is asserted.

IN NO EVENT SHALL OMRON BE RESPONSIBLE FOR WARRANTY, REPAIR, OR OTHER CLAIMS REGARDING THE PRODUCTS UNLESS OMRON'S ANALYSIS CONFIRMS THAT THE PRODUCTS WERE PROPERLY HANDLED, STORED, INSTALLED, AND MAINTAINED AND NOT SUBJECT TO CONTAMINATION, ABUSE, MISUSE, OR INAPPROPRIATE MODIFICATION OR REPAIR.

Application Considerations

SUITABILITY FOR USE

OMRON shall not be responsible for conformity with any standards, codes, or regulations that apply to the combination of products in the customer's application or use of the products.

At the customer's request, OMRON will provide applicable third party certification documents identifying ratings and limitations of use that apply to the products. This information by itself is not sufficient for a complete determination of the suitability of the products in combination with the end product, machine, system, or other application or use.

The following are some examples of applications for which particular attention must be given. This is not intended to be an exhaustive list of all possible uses of the products, nor is it intended to imply that the uses listed may be suitable for the products:

- Outdoor use, uses involving potential chemical contamination or electrical interference, or conditions or uses not described in this catalog.
- Nuclear energy control systems, combustion systems, railroad systems, aviation systems, medical equipment, amusement machines, vehicles, safety equipment, and installations subject to separate industry or government regulations.
- Systems, machines, and equipment that could present a risk to life or property.

Please know and observe all prohibitions of use applicable to the products.

NEVER USE THE PRODUCTS FOR AN APPLICATION INVOLVING SERIOUS RISK TO LIFE OR PROPERTY WITHOUT ENSURING THAT THE SYSTEM AS A WHOLE HAS BEEN DESIGNED TO ADDRESS THE RISKS, AND THAT THE OMRON PRODUCTS ARE PROPERLY RATED AND INSTALLED FOR THE INTENDED USE WITHIN THE OVERALL EQUIPMENT OR SYSTEM.

PROGRAMMABLE PRODUCTS

OMRON shall not be responsible for the user's programming of a programmable product, or any consequence thereof.

Disclaimers

CHANGE IN SPECIFICATIONS

Product specifications and accessories may be changed at any time based on improvements and other reasons.

It is our practice to change model numbers when published ratings or features are changed, or when significant construction changes are made. However, some specifications of the products may be changed without any notice. When in doubt, special model numbers may be assigned to fix or establish key specifications for your application on your request. Please consult with your OMRON representative at any time to confirm actual specifications of purchased products.

DIMENSIONS AND WEIGHTS

Dimensions and weights are nominal and are not to be used for manufacturing purposes, even when tolerances are shown.

PERFORMANCE DATA

Performance data given in this catalog is provided as a guide for the user in determining suitability and does not constitute a warranty. It may represent the result of OMRON's test conditions, and the users must correlate it to actual application requirements. Actual performance is subject to the OMRON Warranty and Limitations of Liability.

ERRORS AND OMISSIONS

The information in this document has been carefully checked and is believed to be accurate; however, no responsibility is assumed for clerical, typographical, or proofreading errors, or omissions.

2008.12

In the interest of product improvement, specifications are subject to change without notice.

OMRON Corporation
Industrial Automation Company

<http://www.ia.omron.com/>

(c)Copyright OMRON Corporation 2008 All Right Reserved.



Компания «ЭлектроПласт» предлагает заключение долгосрочных отношений при поставках импортных электронных компонентов на взаимовыгодных условиях!

Наши преимущества:

- Оперативные поставки широкого спектра электронных компонентов отечественного и импортного производства напрямую от производителей и с крупнейших мировых складов;
- Поставка более 17-ти миллионов наименований электронных компонентов;
- Поставка сложных, дефицитных, либо снятых с производства позиций;
- Оперативные сроки поставки под заказ (от 5 рабочих дней);
- Экспресс доставка в любую точку России;
- Техническая поддержка проекта, помощь в подборе аналогов, поставка прототипов;
- Система менеджмента качества сертифицирована по Международному стандарту ISO 9001;
- Лицензия ФСБ на осуществление работ с использованием сведений, составляющих государственную тайну;
- Поставка специализированных компонентов (Xilinx, Altera, Analog Devices, Intersil, Interpoint, Microsemi, Aeroflex, Peregrine, Syfer, Eurofarad, Texas Instrument, Miteq, Cobham, E2V, MA-COM, Hittite, Mini-Circuits, General Dynamics и др.);

Помимо этого, одним из направлений компании «ЭлектроПласт» является направление «Источники питания». Мы предлагаем Вам помощь Конструкторского отдела:

- Подбор оптимального решения, техническое обоснование при выборе компонента;
- Подбор аналогов;
- Консультации по применению компонента;
- Поставка образцов и прототипов;
- Техническая поддержка проекта;
- Защита от снятия компонента с производства.



Как с нами связаться

Телефон: 8 (812) 309 58 32 (многоканальный)

Факс: 8 (812) 320-02-42

Электронная почта: org@eplast1.ru

Адрес: 198099, г. Санкт-Петербург, ул. Калинина, дом 2, корпус 4, литера А.