

Piezo Switch N.O.



Alu natural
non-illuminated



Gold
non-illuminated



PSE M16

See below:

[Approvals and Compliances](#)

Description

- Available in version Standard and lettered
- Assembly by mounting with nut
- Easy to clean due to a tightly closed surface (IP69K)
- Pins, Wire or Faston

Unique Selling Proposition

- Variety of design options regarding size, colour, shape, connection or lettering
- High reliability, long lifetime with more than 20 mill. actuations

Characteristics

- Housing material types: plastic, aluminum or stainless steel, ring illuminated version additionally made of polyamide
- For use in harsh environments, both indoors and outdoors (see technical data)

Other versions on request

- switch for longer switching signal duration, type: PSE IV
- Switch for explosion proof applications, type: PSE EX
- Switch with enhanced vandal proof protection, type: PSE HI

References

- Alternative: switch vandal improved: [PSE HI 22](#)
- Alternative: switch for EX proved applications: [PSE EX 16](#); [PSE EX 19](#); [PSE EX 22](#)
- Alternative: Other diameter
- Alternative: Other diameter [PSE NO 19](#); [PSE NO 22](#)
- Alternative: switch with prolonged signal: [PSE AE 16](#); [PSE AE 30](#); [PSE IV 19](#)

Weblinks

- [pdf data sheet](#), [html datasheet](#), [General Product Information](#), [CAD-Drawings](#), [Product News](#), [Detailed request for product](#)

Technical Data

Electrical Data

Switching Function	momentary
Switching Voltage	max. 42 / 60 VAC/DC
Switching Current	max. 100 mA
Electrical Rating	1 W
Lifetime	20 million actuations at Rated Switching Capacity
Switch Resistance OFF	> 10 MΩ
Switch Resistance ON	< 20Ω actuated (Ta = 25°C)
Capacity	5 nF
N.O. Closing Impulse Duration	20- 1000 ms depending on actuating force, time and speed
Contact Configuration	free polarity

RGB Illumination

Current Consumption (max per color) -

Mechanical Data

Actuating Force	≤ 3 N at ambient temperature
Actuating Travel	0.002 mm
Shock Protection	IK 02
Mounting screw torque	2.5Nm

Climatical Data

Operating Temperature	-40 to 85 °C
Storage Temperature	-40 to 85 °C
IP-Protection	IP67 acc. to IEC 60529, IP69K acc. to DIN 40050-9
Environmental Assessment	+55°C / 93% r.h. acc. to DIN EN 60068-2-30
Salt Spray Test (acc. to DIN 50021-SS)	24 h / 48 h / 96 h Residence Time

Material

Housing (depending on type)	Stainless Steel, Aluminium anodized, Polyamide
Actuating Area / Insert (with Ring Illumination)	Stainless Steel, Aluminum anodized
Illuminated Ring (Ring Illumination)	Polyamide

Approvals and Compliances

Detailed information on product approvals, code requirements, usage instructions and detailed test conditions can be looked up in [Details about Approvals](#)

SCHURTER products are designed for use in industrial environments. They have approvals from independent testing bodies according to national and international standards. Products with specific characteristics and requirements such as required in the automotive sector according to IATF 16949, medical technology according to ISO 13485 or in the aerospace industry can be offered exclusively with customer-specific, individual agreements by SCHURTER.



Application standards

Application standards where the product can be used

Organization	Design	Standard	Description
	Designed for applications acc.	IEC/UL 62368-1	IEC 62368-1 includes the basic requirements for safety of audio, video, information technology and office equipment.

Compliances

The product complies with following Guide Lines

Identification	Details	Initiator	Description
	RoHS	SCHURTER AG	Directive RoHS 2011/65/EU, Amendment (EU) 2015/863
	REACH	SCHURTER AG	On 1 June 2007, Regulation (EC) No 1907/2006 on the Registration, Evaluation, Authorization and Restriction of Chemicals 1 (abbreviated as "REACH") entered into force.

Dimension [mm]

PSE M16 with Pins

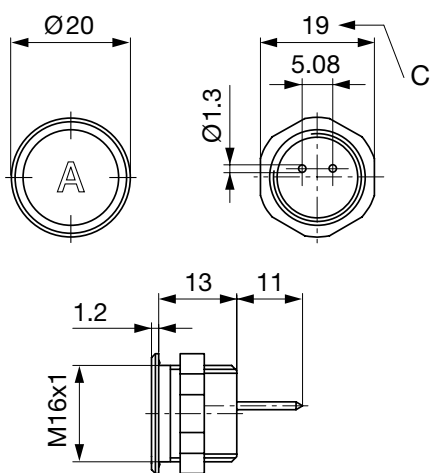

PSE M16 with Faston

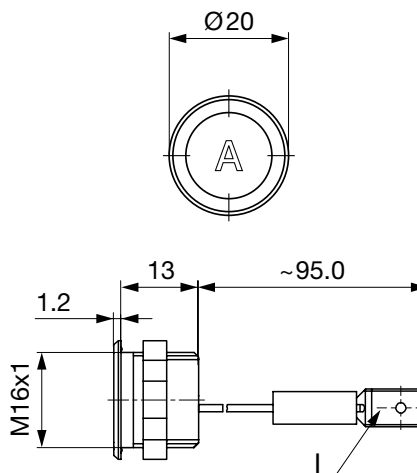

PSE M16 with stranded wire

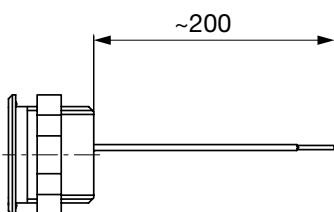

Design actuating area

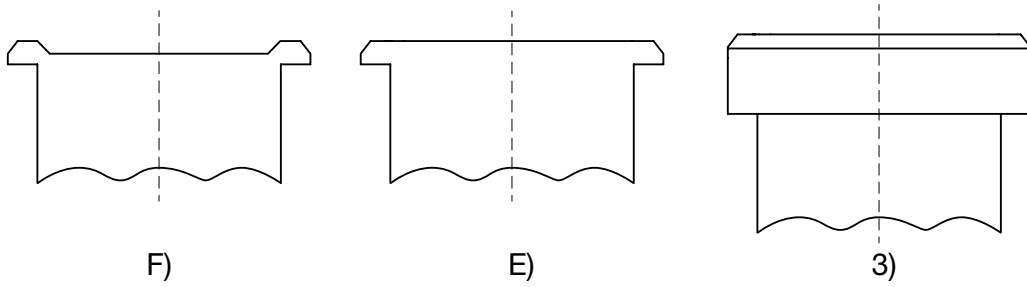

Legende:

C = Schlüsselweite
 l = Flachsteckzunge 6,3 x 0,8

Beschriftung:

- wahlweise mit/ohne Beschriftung
 - Lage der Anschlüsse zur Lage der Beschriftung ist nicht definiert

F) mit Fingerführung

E) ohne Fingerführung

3) erhöhte Frontform M19 (Standard, weitere auf Anfrage)

Dimension

PSE M16

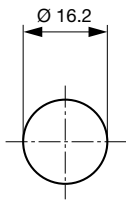

Drilling diagram

Lettering

The last three digits in the order number define the lettering:

001-076	Standard Lettering
101-	Customized Lettering

Lettering - Aluminium / Plastic Material

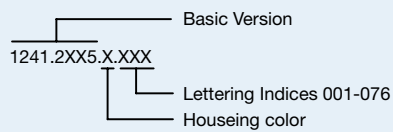

Lettering - Stainless Steel

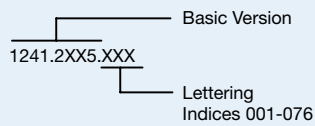

Lettering Colour of Laser Lettering

Material	Lettering Colour	
Stainless Steel	black	Filled letters
Aluminum natural anodized	light grey	Filled letters (only after customer approval)
Aluminum coloured anodized	light grey	Filled letters

Order Index Lettering

Laser Marking			
001 =A	021 =U	041 =⇄	061 =EIN
002 =B	022 =V	042 =*	062 =AUS
003 =C	023 =W	043 ==	063 =AUF
004 =D	024 =X	044 =#	064 =AB
005 =E	025 =Y	045 =↔	065 =ON
006 =F	026 =Z	046 =‡	066 =OFF
007 =G	027 =0	047 =→	067 =UP
008 =H	028 =1	048 =←	068 =DOWN
009 =I	029 =2	049 =↓	069 =HIGH
010 =J	030 =3	050 =↑	070 =LOW
011 =K	031 =4	051 =%	071 =ON/OFF
012 =L	032 =5	052 =√	072 =START
013 =M	033 =6	053 =CTRL	073 =RESET
014 =N	034 =7	054 =RETURN	074 =⏻
015 =O	035 =8	055 =SHIFT	075 =💡
016 =P	036 =9	056 =LOCK	076 =🔔
017 =Q	037 =+	057 =STOP	077 =Ⓜ
018 =R	038 =-	058 =ENTER	
019 =S	039 =.	059 =BACK	
020 =T	040 =x	060 =LINE	

All Variants

Mounting Diameter	Terminal	Housing Material, Torsion Protection	Colour of Housing	Actuator area	Illumination, LED	Config. Code	Order Number
16	Faston	Aluminum ,no	red	F	non-illuminated	PSE M 16 NO Alu/St	1241.3000
16	Faston	Aluminum ,no	green	F	non-illuminated	PSE M 16 NO Alu/St	1241.3001
16	Faston	Aluminum ,no	black	F	non-illuminated	PSE M 16 NO Alu/St	1241.3002
16	Faston	Aluminum ,no	Alu natural	F	non-illuminated	PSE M 16 NO Alu/St	1241.3003
16	Faston	Plastics ,no	Alu natural	F	non-illuminated	PSE M 16 NO K	1241.2356
16	Flexible wire connection	Aluminum ,no	gold	F	non-illuminated	PSE M 16 NO Alu/St	1241.3336.075
16	Pins	Aluminum ,no	gold	F	non-illuminated	PSE M 16 NO Alu/St	1241.2411.1
16	Pins	Aluminum ,no	red	F	non-illuminated	PSE M 16 NO Alu/St	1241.2411.3
16	Pins	Aluminum ,no	blue	F	non-illuminated	PSE M 16 NO Alu/St	1241.2411.4
16	Pins	Aluminum ,no	green	F	non-illuminated	PSE M 16 NO Alu/St	1241.2411.5
16	Pins	Aluminum ,no	black	F	non-illuminated	PSE M 16 NO Alu/St	1241.2411.7
16	Pins	Aluminum ,no	Alu natural	F	non-illuminated	PSE M 16 NO Alu/St	1241.2411.8
16	Pins	Plastics ,no	red	F	non-illuminated	PSE M 16 NO K	1241.2350
16	Pins	Plastics ,no	white	F	non-illuminated	PSE M 16 NO K	1241.2351
16	Pins	Plastics ,no	Alu natural	F	non-illuminated	PSE M 16 NO K	1241.2352
16	Pins	Plastics ,no	black	F	non-illuminated	PSE M 16 NO K	1241.2353
16	Pins	Stainless Steel ,no	-	F	non-illuminated	PSE M 16 NO Alu/St	1241.2611

Nut with gasket are enclosed in the box.

Other mounting diameters, materials, colors, connections, supply voltages possible available on request. Special materials e.g. Marine grade stainless steel for use in salt and chlorinated environment on request.

The MOQ for standard laser lettering on standard variants is a packing unit.

 Most Popular.

Availability for all products can be searched real-time:<https://www.schurter.com/en/Stock-Check/Stock-Check-SCHURTER>

Legend:

Mounting Diameter	Terminal	Housing Material, Torsion Protection	Colour of Housing	Actuator area	Illumination, LED	Config. Code	Order Number
Type: PSE							
NO = normaly open							
K = Plastics							
Alu = Aluminium							
ES = Stainless steel							
F = Finger guidance							
Packaging unit	10 in box with insert or packed in air cushion bags						



- Actuating elements in ESD safe packaging
- Screw nuts and sealing rings in a bag (enclosed in the box)

Accessories

Description



Connecting Terminal PSE
 Connecting Terminal



Компания «ЭлектроПласт» предлагает заключение долгосрочных отношений при поставках импортных электронных компонентов на взаимовыгодных условиях!

Наши преимущества:

- Оперативные поставки широкого спектра электронных компонентов отечественного и импортного производства напрямую от производителей и с крупнейших мировых складов;
- Поставка более 17-ти миллионов наименований электронных компонентов;
- Поставка сложных, дефицитных, либо снятых с производства позиций;
- Оперативные сроки поставки под заказ (от 5 рабочих дней);
- Экспресс доставка в любую точку России;
- Техническая поддержка проекта, помощь в подборе аналогов, поставка прототипов;
- Система менеджмента качества сертифицирована по Международному стандарту ISO 9001;
- Лицензия ФСБ на осуществление работ с использованием сведений, составляющих государственную тайну;
- Поставка специализированных компонентов (Xilinx, Altera, Analog Devices, Intersil, Interpoint, Microsemi, Aeroflex, Peregrine, Syfer, Eurofarad, Texas Instrument, Miteq, Cobham, E2V, MA-COM, Hittite, Mini-Circuits, General Dynamics и др.);

Помимо этого, одним из направлений компании «ЭлектроПласт» является направление «Источники питания». Мы предлагаем Вам помощь Конструкторского отдела:

- Подбор оптимального решения, техническое обоснование при выборе компонента;
- Подбор аналогов;
- Консультации по применению компонента;
- Поставка образцов и прототипов;
- Техническая поддержка проекта;
- Защита от снятия компонента с производства.



Как с нами связаться

Телефон: 8 (812) 309 58 32 (многоканальный)

Факс: 8 (812) 320-02-42

Электронная почта: org@eplast1.ru

Адрес: 198099, г. Санкт-Петербург, ул. Калинина, дом 2, корпус 4, литера А.