

Accessories & Hardware

Contents

Part Number	Page
AT001s	Y3
AT100s	Y5
AT200s	Y6
AT400s	Y8
AT500s	Y13
AT600s	Y16
AT700s	Y18
AT2100s	Y19
AT3000s	Y19
AT4000s	Y23
AT4100s	Y27
AT9000s	Y34

Color Codes

A Black	D Amber	G Blue	P Brushed Chrome
B White	E Yellow	H Gray	S Metallic Silver
C Red	F Green	J Clear	

Hardware Threading

Many hardware pieces are available in both metric and inch threading, and in such cases **M** (metric) and **H** (inch) are noted in the descriptions. The customer must select threading by placing an M or H after the basic AT part number. If the hardware is available only in metric or inch, no code is used in the description; threading is designated on the drawing.

Accessories & Hardware

AT010s~
AT090s

AT016
16mm Hex Mounting Nut
Steel with nickel plating
Series: CKM LP01



AT019
19mm Hex Mounting Nut
Steel with nickel plating
Series: CKL



AT055
Crossover Guard
Polypropylene
Series: KB



AT056
Dress Cap Nut
Brass with chrome plating
Series: M P S



AT056T
Threaded Through Dress Nut
Brass with chrome plating
Series: M P S



AT057
Mounting Nut
Brass with zinc plating,
chromate finish
Series: KB



AT062
.250" Wide Rocker
Polyamide
Colors: A B C
Series: A



AT063
Gasket
Nitrile butadiene rubber
Color: A
Series: B Threaded Bushing



AT064-1
Panel Frame for Rocker &
Paddle .365" Wide
Polyamide
Color: A
Series: M



AT064-2
Panel Frame for Rocker &
Paddle .365" Wide
Polyamide
Color: A
Series: M

AT064-1 accommodates
panel thickness
1.2 ~ 2.3mm
(.047 ~ .090")



AT064-2 accommodates
panel thickness
1.57 ~ 3.18mm
(.062 ~ .125")



Color Codes: A Black B White C Red D Amber E Yellow F Green G Blue H Gray J Clear

Accessories & Hardware

Toggles

Rockers

Pushbuttons

Illuminated PB

Programmable

Keylocks

Rotaries

Slides

Tactiles

Tilt

Touch

Indicators

Accessories

Supplement

AT065-1
Panel Frame for Rocker & Paddle .450" Wide
 Polyamide
 Color: A
 Series: M



AT065-1 accommodates panel thickness 1.2 ~ 2.3mm (.047 ~ .090")



AT065-2
Panel Frame for Rocker & Paddle .450" Wide
 Polyamide
 Color: A
 Series: M

AT066
.300" Wide Rocker
 Polyamide
 Color: A B C
 Series: A



AT065-2 accommodates panel thickness 1.57 ~ 3.18mm (.062 ~ .125")



AT070
LED for AT208 Bezel
 Colors: C F
 Series: EB M MB24



AT073
Mounting Nut
 Brass with nickel plating
 Series: HB



AT074
Mounting Nut for LB Panel Seal
 Brass with chromate
 Series: LB



AT075
O-ring for LB Panel Seal
 Nitrile butadiene rubber
 Series: LB



AT078
.315" (8.0mm) Diameter Screw-on Cap
 Polystyrene
 Colors: A B C E F G H
 Series: MB20 SCB WB



AT079
.394" (10.0mm) Diameter Screw-on Cap
 Polystyrene
 Colors: A B C E F G H
 Series: MB20 SCB WB



AT080
Screw Adaptor for AT452 & AT454
 Brass
 Series: MB20 SCB



AT089
O-ring for YB Panel Seal
 Nitrile butadiene rubber
 Series: YB



Color Codes: A Black B White C Red D Amber E Yellow F Green G Blue H Gray J Clear

Accessories & Hardware

AT092

Knurled Mounting Nut
Glass fiber reinforced PBT
Series: YB YB2 (Square)



AT094

PC Adaptor
Holder: Polypropylene
Spring: Spring steel with nickel plating
PC Pins: Brass with nickel plating
Series: DSA01



AT097

JST Connector for OLED Rocker
JST Part No. BM12B-SURS
PCB Mount
Series: SmartSwitch



AT100s

AT105

Cap Removal Tool
Stainless steel
Series: HB KB LB UB YB



AT106

Socket Wrench
Aluminum with black alumite finish
Series: YB YB2



AT107

Lamp Extractor
Polyvinyl chloride
Series: KB LW MLW YB



AT108

Socket Wrench
Aluminum with black alumite finish
Series: KB



AT109

Cap Extractor
Stainless steel
Series: HB KB LB UB YB



Color Codes: A Black B White C Red D Amber E Yellow F Green G Blue H Gray J Clear

Accessories & Hardware

Toggles

Rockers

Pushbuttons

Illuminated PB

Programmable

Keylocks

Rotaries

Slides

Tactiles

Tilt

Touch

Indicators

Accessories

Supplement

AT110
Socket Wrench
Brass
Series: HB



AT111
Lamping Tool
Stainless steel
Series: HB KB YB



AT112
Socket Wrench
Brass with nickel plating
Series: LB



AT200s

AT201
ON-OFF Plate for
12mm Threaded Bushing
Brass with nickel plating
Series: M P S



AT202
ON-OFF Plate for
12mm Threaded Bushing
Aluminum
Colors: Red & black enamel
Series: M P S



AT204
Bezel
Polycarbonate
Colors: A B C D E F G H
Series: MLW



AT206
Bezel
Polycarbonate
Colors: A B C D E F G H
Series: LW



AT207
Bezel
Polycarbonate
Colors: A B C E F G H
Series: EB MB24 MB25



AT208
Bezel for AT070 LED
Polycarbonate
Color: A
Series: EB M MB24 MB25



Color Codes: A Black B White C Red D Amber E Yellow F Green G Blue H Gray J Clear

Accessories & Hardware

AT209
ON-OFF Plate for 6mm Threaded Bushing
 Brass with nickel plating
 Series: M P



AT210
ON-OFF Plate for 6mm Threaded Bushing
 Aluminum
 Colors: Red & black ink
 Series: M P



AT211
ON-OFF Plate for 6mm Threaded Bushing
 Aluminum
 Colors: Red & black enamel
 Series: M P



AT212
Bezel for 2 AT617 LEDs
 Polycarbonate
 Color: A
 Series: EB M MB24 MB25



AT213
Bezel for 2 AT618 LEDs
 Polycarbonate
 Color: A
 Series: EB M MB24 MB25



AT214
ON-OFF Plate for 12mm Threaded Bushing
 Aluminum
 Colors: Red & black ink
 Series: M P S



AT215
ON-OFF Plate for 12mm Threaded Bushing
 Aluminum
 Colors: Red & black enamel
 Series: M P S



AT217
Barrier
 Polyamide
 Colors: A B H
 Series: JWM



AT218
Barrier
 Polyamide
 Colors: A B H
 Series: JWL



AT219
Barrier
 Polyamide
 Colors: A
 Series: JWS



Color Codes: A Black B White C Red D Amber E Yellow F Green G Blue H Gray J Clear

Accessories & Hardware

AT400s

AT401A/H/S
Splashproof Boot Assembly
 Hex Nut Material & Finish:
 Nickel plated brass
 O-ring Material:
 Nitrile butadiene rubber
 Series: M P S WT



AT401A for Oil Resistance
 Boot Material: Black nitrile butadiene rubber

AT401H for Dust & Ozone Resistance
 Boot Material: Gray ethylene propylene rubber

AT401S for Flexibility, Resilience, and Tensile Strength over Wide Temperature Range
 Boot Material: Black silicone rubber

For 12mm Bushings in M, P, S and WT Toggles

Boot Assembly Instructions

1. After mounting boot AT401 over toggle, press into place.
2. Be sure boot is pressed evenly and firmly down at or below height (A) as shown.



Switch Installation Instructions

1. Install switch bushing into mounting hole of panel from the back and adjust bushing to protrude 3.5 ~ 5.5mm (.138 ~ .217") above panel.
2. Install boot over bushing and tighten with hex nut.

Non-Splashproof Switches

M, P or S Toggles with 12mm Bushings



Use boot, nut and o-ring as shown. Use lockwasher and hexagon nut (from standard switch hardware) behind panel.

Splashproof Switches

S1AW ~ S29AW S Toggles

WT Toggles or M Toggle with B3 Bushing



Use boot, nut and o-ring as shown. Use o-ring only (from standard switch hardware) behind panel.



AT401P
O-ring
 Nitrile butadiene rubber
 Color: A
 Series: M MB20 TL WB WT



AT402
Splashproof Boot
 Silicon rubber for A C E F
 Ethylene propylene rubber for H
 Colors: A C E F H
 Series: M P S



AT402S
Splashproof Boot
 Silicon rubber
 Color: A
 Series: M



AT405
Solid Color Rocker
 Polycarbonate
 Colors: A B C D E F G
 Series: MLW



Color Codes: A Black B White C Red D Amber E Yellow F Green G Blue H Gray J Clear

Accessories & Hardware

AT406

Bat Lever Cap
Polyvinyl chloride
Colors: A B C E F G
Series: M P S



AT407

.394" Diameter Screw-on Cap
PBT
Colors: A B C E F G H
Series: MB20



AT412

.748" Diameter Screw-on Cap
Polystyrene
Colors: A B C F
Series: MB20 SCB WB



AT413

.315" Diameter Screw-on Cap
PBT
Colors: A B C E F G H
Series: MB20



AT414

.520" Diameter Screw-on Cap
PBT
Colors: A B C D E F G H
Series: MB20 SB SCB WB



AT415

Bat Lever Cap
Polyethylene
Colors: A B C E F G
Series: D2 M



AT416

Lamp Cover for AT602
Silicon rubber
Colors: C D F
Series: LW



AT420

Rocker
Polycarbonate
Colors: B J
Series: LW



AT421

Filter for AT420
Polycarbonate
Colors: B C D E F G
Series: LW



AT422

Slip-on Cap
Polyethylene
Colors: A B C E F G
Series: SB40



AT426

Solid Color Paddle
Polycarbonate
Colors: A B C D E F G
Series: MLW



AT427

Cap for Locking Lever (code L)
Brass with bright nickel plating (supplied with switch)
Anodized aluminum
Colors: A C G
Series: D2 M



Color Codes: A Black B White C Red D Amber E Yellow F Green G Blue H Gray J Clear

Accessories & Hardware

Toggles

Rockers

Pushbuttons

Illuminated PB

Programmable PB

Keylocks

Rotaries

Slides

Tactiles

Tilt

Touch

Indicators

Accessories

Supplement

AT428 (M-metric H-inch)
Splashproof Boot
 Silicone rubber
 Color: A
 Series: D2 M P



AT429
Indicator Cap
 Polycarbonate
 Colors: B C D E F G
 Series: P01



AT431
Large Rotary Knob
 Phenolic resin
 Color: A
 Series: HS PS TS



AT432
Small Rotary Knob
 Phenolic resin
 Color: A
 Series: HS PS TS



AT433
Knob for Miniature Rotaries
 Polyacetal
 Color: A
 Series: FR01 MR



AT434
Bat Lever Cap
 Polyvinyl chloride
 Colors: A B C E F G
 Series: M

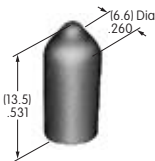

AT435
Screw-on Cap
 Brass with chrome plating
 Series: SB265



AT438
Design Rocker
 Polycarbonate
 Colors: B C D F G
 Series: MLW

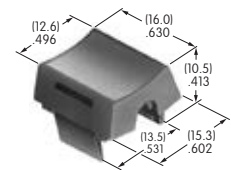

AT442
.394" Diameter Snap-on Cap
 Polycarbonate
 Colors: A B C E F G H
 Series: DB EB M2B MB20 MB25



AT443
.315" Diameter Snap-on Cap
 Polycarbonate
 Colors: A B C E F G H
 Series: DB EB M2B MB20 MB25



AT444
Bat Lever Conical Cap
 Polyethylene
 Colors: A B C E F G
 Series: D2 M M2T

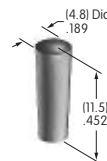

AT445
Cap for Color Tipped Cone Toggle
 Polycarbonate
 Colors: A B C
 Series: M

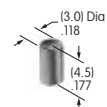

Color Codes: A Black B White C Red D Amber E Yellow F Green G Blue H Gray J Clear

Accessories & Hardware

AT452

Rectangular Insert
Polycarbonate
Colors: A B C F G H
Series: MB20 SCB
Used with Screw Adaptor AT080



AT453

Rectangular Shroud
Polycarbonate
Colors: A B H
Series: MB20 SCB



AT454

Round Insert
Polycarbonate
Colors: A B C F G H
Series: MB20 SCB
Used with Screw Adaptor AT080



AT455

Round Shroud
Polycarbonate
Colors: A B H
Series: MB20 SCB



AT460

Cap for Color Capped Cone Toggle
Polyethylene
Colors: A B C E F G
Series: M



AT465

.453" Square Cap
Polycarbonate
Colors: A B C E F G H
Series: EB MB24 MB25

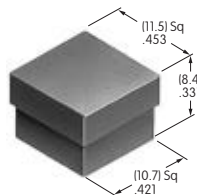

AT466

.453" False Illuminated Rocker
Polycarbonate
Cap Color: A
Window Color: B/C
Series: M



AT467

Short Paddle
Polyamide
Colors: A B C E F G H
Series: A



AT468

Long Paddle
Polyamide
Colors: A B C E F G H
Series: A



AT469

.260" Wide Rocker
Polyamide
Colors: A B C E F G H
Series: A

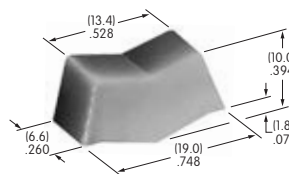

AT475

.201" Diameter Cap
Polyamide
Colors: A B C
Series: AB BB FB M2B MB24



AT476

Square Solid Colored Cap
Polycarbonate
Colors: BJ CJ EJ FJ GJ
Series: LB



Color Codes: A Black B White C Red D Amber E Yellow F Green G Blue H Gray J Clear

Accessories & Hardware

Toggles

Rockers

Pushbuttons

Illuminated PB

Programmable

Keylocks

Rotaries

Slides

Tactiles

Tilt

Touch

Indicators

Accessories

Supplement

AT477
Square Colored Insert Cap
 Polycarbonate
 Colors: JB JC JE JF JG
 Series: LB



AT480
Square Spot Illuminated Cap
 Polycarbonate
 Cap Colors: A B C F
 LED Colors: C D F CF
 Series: LB



AT484
Square Nonilluminated Cap
 Polycarbonate
 Colors: A B C E F G H
 Series: LB



AT485
Square Solid Colored Cap
 Polycarbonate
 Colors: A BB CB CC EB
 FB FF GB GG
 Series: KB



AT486
Round Solid Colored Cap
 Polycarbonate
 Colors: A BB CB CC EB
 FB FF GB GG
 Series: KB



AT487
Square Colored Insert Cap
 Polycarbonate
 Colors: JB JC JE JF JG
 Series: KB



AT488
Round Colored Insert Cap
 Polycarbonate
 Colors: JB JC JE JF JG
 Series: KB



AT494
Protective Guard
 Cover: Polycarbonate
 Base: Polyamide
 Series: KB



AT495
Dust Cover
 Lid: Polyvinyl chloride
 Base: Polyamide
 Series: KB



AT496
.295" Diameter Cap
 Polyamide
 Colors: A B C
 Series: AB BB FB M2B MB24



AT497
End Barrier
 Polyamide
 Color: A
 Series: LB



AT498
Center Barrier
 Polyamide
 Color: A
 Series: LB



Color Codes: A Black B White C Red D Amber E Yellow F Green G Blue H Gray J Clear

Accessories & Hardware

AT499
Protective Guard for Square Cover: Polycarbonate
 Base: Polyamide
 Series: LB



AT500s

AT501 (M-metric H-inch)
Knurled Face Nut
 Brass with chrome plating
 Series: D2 DB EB M MB20 MB24 P



AT503 (M-metric H-inch)
Hex Face Nut
 Brass with chrome plating
 Series: M P S SB WB WT



AT504M
Knurled Face Nut
 Brass with chrome plating
 Series: M P S SB SCB WB WT



AT506M
Locking Ring
 Steel with zinc/chromate
 Series: M MB20 P S SB



AT507 (M-metric H-inch)
Locking Ring
 Steel with zinc/chromate
 Series: D2 DB EB M MB20 MB24 MB25 MR P



AT508
Internal Tooth Lockwasher
 Steel with zinc/chromate
 Series: M P S SB SCB SK TL WB WT



AT509
Internal Tooth Lockwasher
 Steel with zinc/chromate
 Series: D2 DB EB FR01 M MB25 MR P S SB



AT512 (M-metric H-inch)
Conical Nut
 Brass with chrome plating
 Series: EB MB20



AT512C (M-metric H-inch)
Conical Nut
 Brass with chrome plating
 Series: EB MB20



AT513H
Hex Nut
 Brass with nickel plating
 Series: M MB20 MB24



Color Codes: A Black B White C Red D Amber E Yellow F Green G Blue H Gray J Clear

Accessories & Hardware

Toggle

Rockers

Pushbuttons

Illuminated PB

Programmable

Keylocks

Rotaries

Slides

Tactiles

Tilt

Touch

Indicators

Accessories

Supplement

AT513M

Hex Nut

Brass with nickel plating
Series: B D2 DB EB FRO1 M
MB20 MB25 MR P



AT515 (M-metric H-inch)

Locking Ring for D Flat Bushing

Steel with zinc/chromate
Series: FRO1 M MB24



AT516

O-ring

Nitrile butadiene rubber
Series: M MB20



AT518

Locking Ring

Steel with zinc/chromate
Series: HS PS TS



AT520

Split Lockwasher

Steel with zinc/chromate
Series: HS PS TS



AT526

Hex Mounting Nut

Steel with nickel plating
Series: HS PS TS



AT527 (M-metric H-inch)

Hex Mounting Nut

Steel with nickel plating
Series: M P S SB SCB
SK TL



AT527MA

Black Hex Face Nut

Steel with black chrome plating
Series: TL

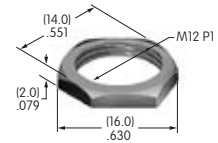

AT529

Mounter for Square Cap

Stainless steel frame
GFR PBT spacer
Series: EB



AT530

Panel Mount for Single Pole

Polyamide & polyacetel
Colors: A B C E F G H
Series: A AB

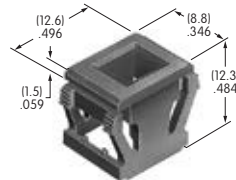

AT531

Panel Mount for Single or Double Pole

Polyamide & polyacetel
Colors: A B C E F G H
Series: A AB

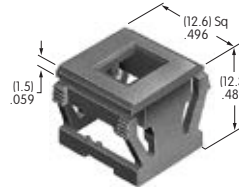

AT532 (M-metric H-inch)

Dress Cap Nut

Brass with nickel plating
Series: EB M MB20 MB24 P



Color Codes: A Black B White C Red D Amber E Yellow F Green G Blue H Gray J Clear

Accessories & Hardware

AT532T (M-metric H-inch)
Threaded Through Dress Nut
 Brass with nickel plating
 Series: EB M MB20 MB24 P



AT533T (M-metric H-inch)
Threaded Through Dress Nut
 Brass with nickel plating
 Series: EB M MB20 MB24 P



AT535
Rubber Ring for MR Panel Seal
 Nitrile butadiene rubber
 Series: MRB MRK



AT536
Hex Nut
 Brass with nickel plating
 Series: FB



AT537
O-ring
 Nitrile butadiene rubber
 Series: S



AT541
O-ring for Panel Seal with AT4115
 Nitrile butadiene rubber
 Series: YB



AT542
Coupler for LCD 36 x 24 Pushbutton
 PBT
 Series: SmartSwitch



AT543
Support Bracket
 Steel with tin plating
 Series: MRK



AT545
Locking Ring
 Steel with zinc/chromate
 Series: MRA MRB MRK



AT546
Mounting Bracket for Block Mounting
 Phosphor bronze with tin plating
 Series: GB2



AT547
Mounter for AT4140
 Polyamide
 Color: A
 Series: JB



AT548
Panel Mount Housing for LCD 36 x 24 Pushbutton (not for Compact SmartSwitch)
 Polyamide
 Color: A
 Series: SmartSwitch

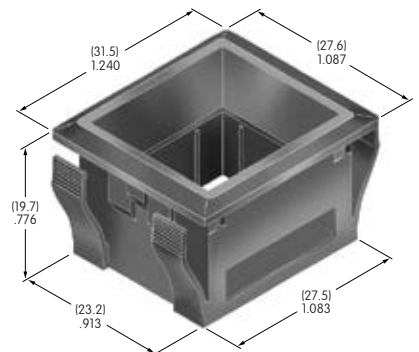

Color Codes: A Black B White C Red D Amber E Yellow F Green G Blue H Gray J Clear

Toggles
 Rockers
 Pushbuttons
 Illuminated PB
 Programmable
 Keylocks
 Rotaries
 Slides
 Tactiles
 Tilt
 Touch
 Indicators
 Supplement

Y
 Accessories

Accessories & Hardware

Toggles

Rockers

Pushbuttons

Illuminated PB

Programmable

Keylocks

Rotaries

Slides

Tactiles

Tilt

Touch

Indicators

Accessories

Supplement

AT600s

AT602
Incandescent Lamp
Volts: 6 12 18 24 28
Series: LW MLW
T-1 1/2 Pilot Slide Base



AT602N
Neon Lamp
Volts: 110
Series: LW MLW
T-1 1/2 Pilot Slide Base



AT607
Incandescent Lamp
Volts: 5 12
Series: LB
T-1 Bi-pin



AT607N
Neon Lamp
Volts: 110
Series: LB
T-1 Bi-pin



AT611
Incandescent Lamp
Volts: 5 12
Series: KB YB
T-1 Bi-pin



AT615
Neon Lamp
Volts: 110
Series: KB
T-1 Bi-pin



AT617
Single Element LED
Colors: C E F
Used for AT212 Bezel



AT618
Single Element LED
Colors: C E F
Used for AT213 Bezel



AT621
6-element Bicolor LED
Without Resistor; Volts: 2
With Resistor; Volts: 5 12 24
Colors: CF
Series: YB
T-1 1/2 Bi-pin



AT622
Single Element LED
Colors: C E F
Series: MLW
T-1 3/4 Pilot Slide Base



AT624
Single Element LED
Color: G
Series: HB
T-1 Bi-pin



Color Codes: A Black B White C Red D Amber E Yellow F Green G Blue H Gray J Clear

Accessories & Hardware

AT625

**Super Bright
Single Element LED**
Color: G
Series: KB LB YB YB2
T-1 Bi-pin



AT627

**Bright
4-Element LED**
With Resistor; Volts: 5 12 24
Colors: C D F
Series: LB
T-1 Bi-pin



AT628

**Bright
Double Element LED**
Colors: C D F
Series: YB YB2
T-1 Bi-pin



AT629

Single Element LED
Color: B
Series: HB
T-1 Bi-pin



AT630

Single Element LED
Color: F
Series: HB
T-1 Bi-pin



AT631

**Super Bright
Single Element LED**
Color: B
Series: KB LB YB YB2
T-1 Bi-pin



AT632

**Super Bright
Single Element LED**
Color: F
Series: KB LB YB YB2
T-1 Bi-pin



AT633

Single Element LED
Colors: C D F
Series: HB
T-1 Bi-pin



AT634

**Bright
2- or 4-Element LED**
With Resistor; Volts: 5 12 24
Colors: C D F
Series: KB YB YB2
T-1 1/4 Bi-pin



AT635

**Bright
Single Element LED**
Colors: C D F
Series: KB LB
T-1 1/2 Bi-pin



AT636

**Bright
Single Element LED**
With Resistor; Volts: 5 12 24
Color: F
Series: YB2
T-1 1/4 Bi-pin



Color Codes: A Black B White C Red D Amber E Yellow F Green G Blue H Gray J Clear

Accessories & Hardware

Toggles

Rockers

Pushbuttons

Illuminated PB

Programmable

Keylocks

Rotaries

Slides

Tactiles

Tilt

Touch

Indicators

Accessories

Supplement

AT700s

AT701
Single Pole
Straight PC Adaptor
 Glass fiber reinforced polyamide
 Series: KB

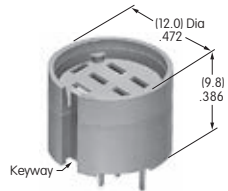

AT702
Double Pole
Straight PC Adaptor
 Glass fiber reinforced polyamide
 Series: KB



AT711
Single Pole
Straight PC Adaptor
 Glass fiber reinforced polyamide
 Series: LB



AT712
Double Pole
Straight PC Adaptor
 Glass fiber reinforced polyamide
 Series: LB



AT713
Receptacle Connector
 Connects to RS232C
 Compatible with FTCS04B & FTCS05B (5-wire) or FTCS04A & FTCS04A2 (4 wire)
 Length: 19.7" (500.0mm)
 Series: FT



AT714
Receptacle Connector
 Connects to Power Source of Control Boards
 FTCS04B & FTCS05B (5-wire)
 Length: 19.7" (500.0mm)
 Series: FT



AT715
Connector Cable
 Cable for OLED Rocker
 Length: 19.7" (500.0mm)
 Series: SmartSwitch



AT716
Single Pole Solder Lug/Quick Connect Adaptor
 Glass fiber reinforced polyamide
 Series: LP01, YB, YB2



AT717
Double Pole Solder Lug/Quick Connect Adaptor
 Glass fiber reinforced polyamide
 Series: LP01, YB, YB2



AT718
Single Pole Straight PC Adaptor
 Glass fiber reinforced polyamide
 Series: LP01, YB, YB2



AT719
Double Pole Straight PC Adaptor
 Glass fiber reinforced polyamide
 Series: LP01, YB, YB2



Color Codes: A Black B White C Red D Amber E Yellow F Green G Blue H Gray J Clear

Accessories & Hardware

Toggles

Rockers

Pushbuttons

Programmable
Illuminated PB

Keylocks

Rotaries

Slides

Tactiles

Tilt

Touch

Indicators

Supplement
Y
Accessories

AT2100s

AT2107
Bezel
Polyamide
Colors: A B E F G H
Series: M M2100



AT3000s

AT3001
Square Solid Cap
Polycarbonate
Colors: BB CB EB FB GB
Series: YB



AT3002
Round Solid Cap
Polycarbonate
Colors: BB CB EB FB GB
Series: YB



AT3003
Rectangular Solid Cap
Polycarbonate
Colors: BB CB EB FB GB
Series: YB



AT3004
Square Cap for Bright LED & Bicolor
Polycarbonate
Colors: JB JC JD JF
Series: YB



AT3005
Round Cap for Bright LED & Bicolor
Polycarbonate
Colors: JB JC JD JF
Series: YB



AT3006
Rectangular Cap for Bright LED & Bicolor
Polycarbonate
Colors: JB JC JD JF
Series: YB



AT3010
Square Spot Illuminated Cap with Built-in LED
Without Resistor; Volts: 2
With Resistor; Volts: 5 12 24
Polycarbonate
Cap Colors: JA JB JC JE JF
LED Colors: C D F CF
Series: YB



AT3011
Round Spot Illuminated Cap with Built-in LED
Without Resistor; Volts: 2
With Resistor; Volts: 5 12 24
Polycarbonate
Cap Colors: JA JB JC JE JF
LED Colors: C D F CF
Series: YB



AT3012
Rectangular Spot Illuminated Cap with Built-in LED
Without Resistor; Volts: 2
With Resistor; Volts: 5 12 24
Polycarbonate
Cap Colors: JA JB JC JE JF
LED Colors: C D F CF
Series: YB



Color Codes: A Black B White C Red D Amber E Yellow F Green G Blue H Gray J Clear

Accessories & Hardware

Toggle

Rockers

Pushbuttons

Illuminated PB

Programmable

Keylocks

Rotaries

Slides

Tactiles

Tilt

Touch

Indicators

Accessories

Supplement

AT3014
Square Cap for Super Bright LED
 Polycarbonate
 Color: JB
 Series: YB

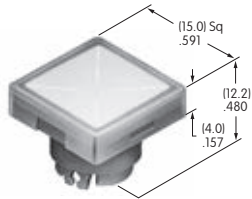

AT3015
Round Cap for Super Bright LED
 Polycarbonate
 Color: JB
 Series: YB

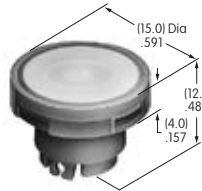

AT3016
Rectangular Cap for Super Bright LED
 Polycarbonate
 Color: JB
 Series: YB

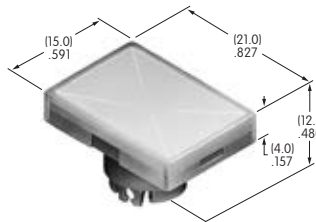

AT3017
Round Cap for Bright LED or Nonilluminated
 Polycarbonate
 HB Lens: ABS Resin & Unbrushed Chrome Plating
 Colors: JB CB EB FB HB
 Series: YB2



AT3018
Round Cap for Super Bright LED
 Polycarbonate
 HB Lens: ABS Resin & Unbrushed Chrome Plating
 Colors: JB HB
 Series: YB2

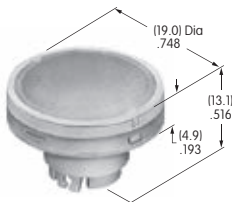

AT3019
Round Solid Cap for Nonilluminated
 ABS Resin & Brushed Chrome Plating
 Color: P (Brushed Chrome)
 Series: YB2



AT3020
Round Cap with Clear Illumination Ring for Bright or Super Bright LED
 Lens: Polycarbonate
 Insert: Polyester
 Color: JS (Metallic Silver with Clear Ring)
 Series: YB2

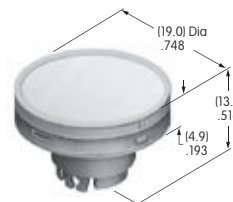

AT3021
Flat Cap for Barrier Flange
 Polyphenylene oxide
 Colors: A B C H
 Series: JP

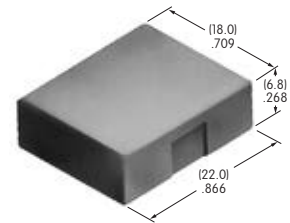

AT3022
Square Cap for Single or Bicolor LED
 Polycarbonate Resin
 Colors: JB JC JD JF
 Series: NP01



AT3023
Square Cap for Bicolor LED with Alternating Legends
 Polycarbonate Resin
 Color: J
 Series: NP01



AT3024
Square Solid Cap
 Polycarbonate Resin
 Colors: A B C H
 Series: NP01



AT3025
Square Cap for Bright & Super Bright LED or Nonilluminated
 Polycarbonate
 Colors: JB CB EB FB HB
 Series: YB2

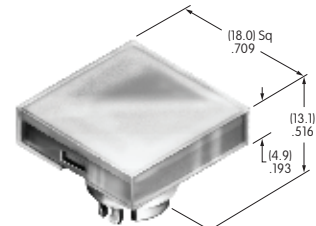

Color Codes: A Black B White C Red D Amber E Yellow F Green G Blue H Gray J Clear

Accessories & Hardware

AT3027

Square Solid Cap for Nonilluminated
 ABS Resin &
 Brushed Chrome Plating
 Color: P (Brushed Chrome)
 Series: YB2



AT3069

Sculptured Cap with Alternating Legend for Illuminated
 Polycarbonate
 Color: J
 Series: UB2



AT3070

Flat Cap with Alternating Legend for Illuminated
 Polycarbonate
 Color: J
 Series: UB2



AT3073

Sculptured Cap for Nonilluminated
 Polycarbonate
 Colors: JA JB JC JD JF
 Series: UB2



AT3074

Sculptured Cap for Illuminated
 Polycarbonate
 Colors: JB JC JD JF
 Series: UB2



AT3075

Beveled Cap for Illuminated
 Polycarbonate
 Colors: B C D F
 Series: UB2



AT3076

Flat Cap for Illuminated with Lens/Diffuser
 Polycarbonate
 Colors: JB JC JD JF
 Series: UB2



AT3077

Beveled Cap for Nonilluminated
 Polycarbonate
 Colors: A B C D F
 Series: UB2



AT3078

12mm Sculptured Cap with Lens/Diffuser
 Polycarbonate
 Color: JB
 Series: KP



AT3079

15mm Sculptured Cap with Lens/Diffuser
 Polycarbonate
 Color: JB
 Series: KP



AT3080

17.4mm Sculptured Cap with Lens/Diffuser
 Polycarbonate
 Color: JB
 Series: KP



AT3081

Transparent Lens
 Polycarbonate
 Color: J
 Series: HB2



Color Codes: A Black B White C Red D Amber E Yellow F Green G Blue H Gray J Clear

Accessories & Hardware

Toggles

Rockers

Pushbuttons

Illuminated PB

Programmable

Keylocks

Rotaries

Slides

Tactiles

Tilt

Touch

Indicators

Accessories

Supplement

AT3082
Translucent Diffuser
 Polycarbonate
 Color: B
 Series: HB2



AT3083
12mm Flat Cap with Lens/Diffuser
 Polycarbonate
 Color: JB
 Series: KP



AT3084
15mm Flat Cap with Lens/Diffuser
 Polycarbonate
 Color: JB
 Series: KP



AT3085
17.4mm Flat Cap with Lens/Diffuser
 Polycarbonate
 Color: JB
 Series: KP



AT3086
12mm Home Key Cap with Lens/Diffuser
 Polycarbonate
 Color: JB
 Series: KP



AT3087
15mm Home Key Cap with Lens/Diffuser
 Polycarbonate
 Color: JB
 Series: KP



AT3088
17.4mm Home Key Cap with Lens/Diffuser
 Polycarbonate
 Color: JB
 Series: KP



AT3090
12.0mm Square Sculptured Cap with Alternating Legends
 Polycarbonate
 Color: J
 Series: KP



AT3091
15.0mm Square Sculptured Cap with Alternating Legends
 Polycarbonate
 Color: J
 Series: KP



AT3092
17.4mm Square Sculptured Cap with Alternating Legends
 Polycarbonate
 Color: J
 Series: KP



AT3093
12.0mm Square Flat Cap with Alternating Legends
 Polycarbonate
 Color: J
 Series: KP



AT3094
15.0mm Square Flat Cap with Alternating Legends
 Polycarbonate
 Color: J
 Series: KP



Color Codes: A Black B White C Red D Amber E Yellow F Green G Blue H Gray J Clear

Accessories & Hardware

AT3095
17.4mm Square
Flat Cap with
Alternating Legends
 Polycarbonate
 Color: J
 Series: KP



AT3096
12.0mm Square
Home Key Cap with
Alternating Legends
 Polycarbonate
 Color: J
 Series: KP



AT3097
15.0mm Square
Home Key Cap with
Alternating Legends
 Polycarbonate
 Color: J
 Series: KP



AT3098
17.4mm Square
Home Key Cap with
Alternating Legends
 Polycarbonate
 Color: J
 Series: KP



AT4000s

AT4001
Square Dust Cover
 Lid: Polyvinyl chloride
 Gasket: Polyethylene
 Series: LB UB



AT4002
Round Dust Cover
 Lid: Polyvinyl chloride
 Gasket: Polyethylene
 Series: LB



AT4003
.394" Bat Lever Cap
 Polyvinyl chloride
 Colors: A B C
 Series: A B



AT4011
Rectangular Dust Cover
 Lid: Polyvinyl chloride
 Gasket: Polyethylene
 Series: LB UB



Color Codes: A Black B White C Red D Amber E Yellow F Green G Blue H Gray J Clear

Accessories & Hardware

Toggles

Rockers

Pushbuttons

Illuminated PB

Programmable

Keylocks

Rotaries

Slides

Tactiles

Tilt

Touch

Indicators

Accessories

Supplement

AT4012
Round Solid Colored Cap
 Polycarbonate
 Colors: BJ CJ EJ FJ GJ
 Series: LB



AT4013
Round Colored Insert Cap
 Polycarbonate
 Colors: JB JC JE JF JG
 Series: LB



AT4016
Round Spot Illuminated Cap
 Polycarbonate
 Cap Colors: A B C F
 LED Colors: C D F CF
 Series: LB



AT4017
Round Nonilluminated Cap
 Polycarbonate
 Colors: A B C E F G H
 Series: LB



AT4021
Rectangular Solid Colored Cap
 Polycarbonate
 Colors: A BB CB CC EB
 FB FF GB GG
 Series: KB



AT4022
Rectangular Colored Insert Cap
 Polycarbonate
 Cap Colors: JB JC JE JF JG
 Series: KB



AT4024
Protective Guard
 Cover: Polycarbonate
 Base: Polyamide
 Series: KB



AT4025
Rectangular Dust Cover
 Lid: Polyvinyl chloride
 Base: Polyamide
 Series: KB



AT4026
Rectangular Solid Colored Cap
 Polycarbonate
 Colors: BJ CJ EJ FJ GJ
 Series: LB



AT4027
Rectangular Colored Insert Cap
 Polycarbonate
 Colors: JB JC JE JF JG
 Series: LB

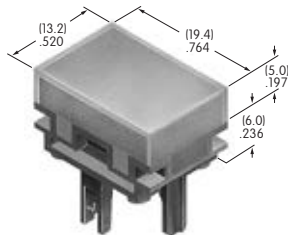

AT4030
Rectangular Nonilluminated Cap
 Polycarbonate
 Colors: A B C E F G H
 Series: LB



AT4031
Square Cap for Bright & Super Bright LED
 Polycarbonate
 Colors: JB
 Series: HB



Color Codes: A Black B White C Red D Amber E Yellow F Green G Blue H Gray J Clear

Accessories & Hardware

AT4032
Round Cap for Bright & Super Bright LED
 Polycarbonate
 Colors: JB
 Series: HB



AT4033
Square Indicator Cap
 Polycarbonate
 Colors: JB
 Series: HB



AT4034
Round Indicator Cap
 Polycarbonate
 Colors: JB
 Series: HB



AT4035
Square Nonilluminated Cap
 Polycarbonate
 Colors: A B C E F G
 Series: HB



AT4036
Round Nonilluminated Cap
 Polycarbonate
 Colors: B C E F G
 Series: HB



AT4041 (M-metric H-inch)
Splashproof Boot for Momentary
 Black silicone rubber
 Series: MB



AT4042 (M-metric H-inch)
Splashproof Boot for Alternate
 Black silicone rubber
 Series: MB



AT4043
Splashproof Boot
 Black silicone rubber
 Series: MB SB WB



AT4051
Spot Illuminated Cap
 Polycarbonate
 Colors: AB
 Series: KB



AT4052
Spot Illuminated Cap
 Polycarbonate
 Colors: AB
 Series: HB



AT4054
Round Solid Colored Cap
 Polycarbonate
 Colors: BJ CJ EJ FJ GJ
 Series: LB Panel Seal



AT4055
Round Colored Insert Cap
 Polycarbonate
 Colors: JB JC JE JF JG
 Series: LB Panel Seal



Color Codes: A Black B White C Red D Amber E Yellow F Green G Blue H Gray J Clear

Accessories & Hardware

Toggle

Rocker

Pushbuttons

Illuminated PB

Programmable

Keylocks

Rotaries

Slides

Tactiles

Tilt

Touch

Indicators

Accessories

Supplement

AT4057
Protective Guard
 Polycarbonate
 Series: LB



AT4058
Sculptured Cap
 Polyamide
 Colors: A B C E F G H
 Series: JB



AT4059
Flat Cap
 Polycarbonate
 Colors: A B C E F G H
 Series: JB



AT4060
Clear Cap with Colored Diffuser
 Polycarbonate
 Colors: JB JC JE JF
 Series: JB



AT4062
Rocker
 Polyamide
 Colors: A B C
 Series: G



AT4063
.157" Diameter Slip-on Cap
 Polyamide
 Colors: A B C
 Series: GB G3B



AT4064
.248" Bat Lever Cap
 Polyvinyl chloride
 Polyamide
 Colors: A B C
 Series: A B



AT4065
Slide Cap
 Polycarbonate
 Cap Color: A
 Window: C E F
 Series: SS



AT4072
Protective Guard
 Lid: Polycarbonate
 Base: Glass fiber reinforced polycarbonate
 Series: YB



AT4073
Square Opaque Cap for Nonilluminated
 Polycarbonate
 Colors: A B C E F G
 Series: UB



AT4074
Square Transparent Cap for Illuminated
 Polycarbonate
 Colors: C D F J
 Series: UB



AT4075
Diffuser for AT4074 Square Cap
 Polycarbonate
 Colors: B C D F
 Series: UB



Color Codes: A Black B White C Red D Amber E Yellow F Green G Blue H Gray J Clear

Accessories & Hardware

AT4076

Button with Frame for Illuminated

Polycarbonate
Colors: BB BC BE BF BH
Series: JB



AT4077

Button for Nonilluminated

Polycarbonate
Colors: B C E F G H
Series: JB



AT4078

Frame for AT4077

Polycarbonate
Colors: B C E F G H
Series: JB



AT4079

Actuator Key
Brass alloy with bright nickel plating
Series: SK



AT4080

Actuator Key

Brass alloy with bright nickel plating
Antistatic ABS resin handle
Color: A
Series: SK



AT4081

Actuator Key

Zinc alloy with chrome plating
Series: SK



AT4082

Actuator Key

Zinc alloy with chrome plating
Series: SK



AT4094

Actuator Key

Polyacetal
Color: A
Series: SK



AT4100s

AT4103

Small Color Tipped Knob

Polyester with polyamide tip
Base Color: A
Tip Colors: A B C E F G H
Series: FR01 MR



AT4104

Large Color Tipped Knob

Polyester with polyamide tip
Base Color: A
Tip Colors: A B C E F G H
Series: FR01 MR



AT4115

Dust Cover

Lid: Polyvinyl chloride
Base: Polyamide
Series: YB



Color Codes: A Black B White C Red D Amber E Yellow F Green G Blue H Gray J Clear

Accessories & Hardware

Toggle

Rocker

Pushbutton

Illuminated PB

Programmable

Keylocks

Rotaries

Slides

Tactiles

Tilt

Touch

Indicators

Accessories

Supplement

AT4116
Rectangular Opaque Cap for Nonilluminated
 Polycarbonate
 Colors: A B C E F G
 Series: UB



AT4117
Rectangular Transparent Cap for Illuminated
 Polycarbonate
 Colors: C D F J
 Series: UB



AT4118
Diffuser for AT4117 Rectangular Transparent Cap
 Polycarbonate
 Colors: B C D F
 Series: UB



AT4119
Square Spot Illuminated Cap
 Polycarbonate
 Colors: AB
 Series: UB



AT4120
Rectangular Spot Illuminated Cap
 Polycarbonate
 Colors: AB
 Series: UB



AT4124
Actuator Key
 Brass with nickel plating
 Series: SK



AT4125
LED Rocker
 Polycarbonate
 Colors: B C E F
 Series: MLW



AT4126
Dust Cover
 Polyvinyl chloride & polyamide
 Color: A
 Series: JWJ



AT4127
Sculptured Rocker
 Polycarbonate
 Colors: B C E F
 Series: MLW



AT4128
Round Cap for Super Bright LED
 Polycarbonate
 Colors: JB
 Series: LB



AT4129
Square Cap for Super Bright LED
 Polycarbonate
 Colors: JB
 Series: LB



AT4130
Rectangular Cap for Super Bright LED
 Polycarbonate
 Colors: JB
 Series: LB



Color Codes: A Black B White C Red D Amber E Yellow F Green G Blue H Gray J Clear

Accessories & Hardware

AT4131
Round Cap for Super Bright LED
 Polycarbonate
 Colors: JB
 Series: LB Panel Seal



AT4132
Round Cap for Bright & Super Bright LED
 Polycarbonate
 Colors: JB
 Series: KB



AT4133
Square Cap for Bright & Super Bright LED
 Polycarbonate
 Colors: JB
 Series: KB



AT4134
Rectangular Cap for Bright & Super Bright LED
 Polycarbonate
 Colors: JB
 Series: KB



AT4135
Frosted Cap with White Base
 Polycarbonate
 Colors: B C E F
 Series: JB



AT4137
Rectangular Cap
 PBT
 Colors: A B C
 Series: GB2



AT4139
Square Flat Cap
 Polycarbonate
 Colors: A B C H
 Series: JB



AT4140
Cap for Mounter AT547
 Polycarbonate
 Colors: A B C H
 Series: JB



AT4141
Protective Guard
 Cover: Polycarbonate
 Base: GFR polyamide
 Series: UB2



AT4142
Spring Loaded Protective Guard
 Cover: Polycarbonate
 Base: GFR polyamide
 Coil spring: Stainless steel
 Series: UB2



AT4143
End Barrier
 Polyamide
 Color: A
 Series: UB2



AT4144
Center Barrier
 Polyamide
 Color: A
 Series: UB2



Color Codes: A Black B White C Red D Amber E Yellow F Green G Blue H Gray J Clear

Accessories & Hardware

Toggle

Rockers

Pushbuttons

Illuminated PB

Programmable

Keylocks

Rotaries

Slides

Tactiles

Tilt

Touch

Indicators

Accessories

Supplement

AT4145
Square Dust Cover
 Lid: PVC
 Gasket: Polyethylene
 Series: UB2

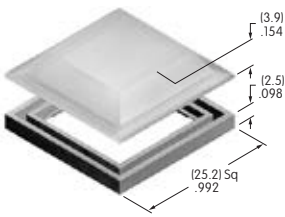

AT4146
Tubular Key
 Brass with nickel plating
 ABS handle
 Color: A
 Series: CKM

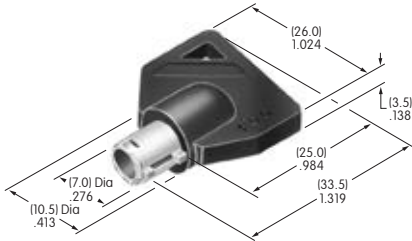

AT4147
Flat Key
 Brass with nickel plating
 ABS handle
 Color: A
 Series: CKM

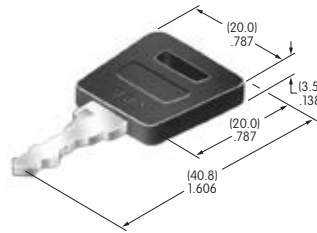

AT4148
.365" Wide Rocker
 Polyamide
 Colors: A B C E F G H
 Series: M M2T P

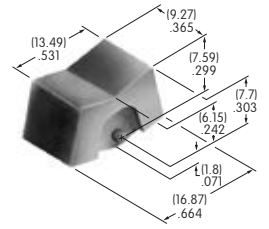

AT4149
.365" Wide Paddle
 Polyamide
 Colors: A B C E F G H
 Series: M M2T P

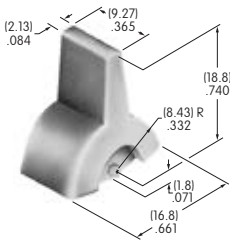

AT4150
.450" Wide Rocker
 Polyamide
 Colors: A B C E F G H
 Series: M M2T

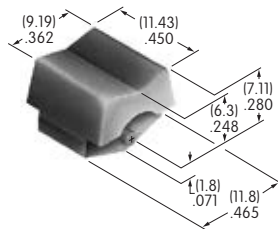

AT4151
.450" Wide Paddle
 Polyamide
 Colors: A B C E F G H
 Series: M M2T

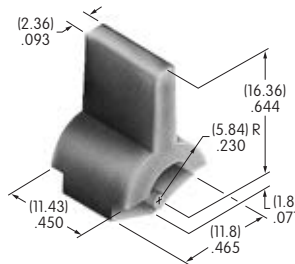

AT4152
Tubular Key
 Brass with nickel plating
 Series: CKL

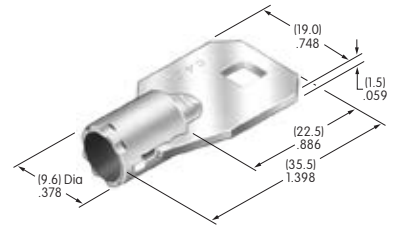

AT4153
Flat Key
 Brass with chrome plating
 Series: CKL

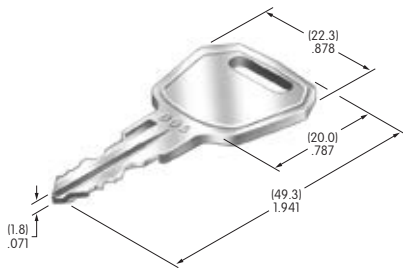

AT4156
.595" Wide Rocker
 Polyamide
 Colors: A B C E F G H
 Series: M P

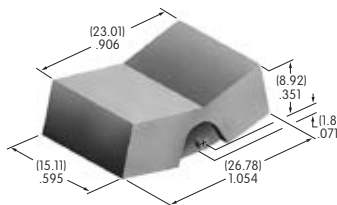

AT4157
.595" Wide Paddle
 Polyamide
 Colors: A B C E F G H
 Series: M P

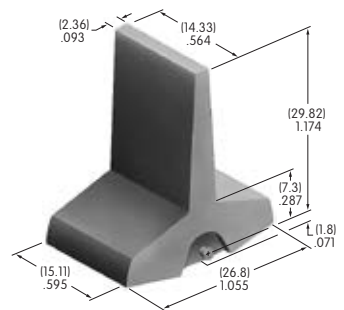

Color Codes: A Black B White C Red D Amber E Yellow F Green G Blue H Gray J Clear

Accessories & Hardware

AT4158

Square Cap for Bright LED
Polycarbonate
Colors: JC JD JF
Series: KB



AT4159

Rectangular Cap for Bright LED
Polycarbonate
Colors: JC JD JF
Series: KB



AT4160

Round Cap for Bright LED
Polycarbonate
Colors: JC JD JF
Series: KB



AT4162

Square Cap for Bright LED
Polycarbonate
Colors: JB JC JD JF
Series: LB



AT4163

Rectangular Cap for Bright LED
Polycarbonate
Colors: JB JC JD JF
Series: LB



AT4164

Round Cap for Bright LED
Polycarbonate
Colors: JB JC JD JF
Series: LB



AT4165

Round Cap for Bright LED
Polycarbonate
Colors: JB JC JD JF
Series: LB Panel Seal



AT4166

Square Cap for Bright LED
Polycarbonate
Colors: CB DB FB
Series: HB



AT4167

Round Cap for Bright LED
Polycarbonate
Colors: CB DB FB
Series: HB



AT4168

Square Indicator Cap for Bright LED
Polycarbonate
Colors: CB DB FB
Series: HB



AT4169

Round Indicator Cap for Bright LED
Polycarbonate
Colors: CB DB FB
Series: HB



Color Codes: A Black B White C Red D Amber E Yellow F Green G Blue H Gray J Clear

Accessories & Hardware

Toggle

Rockers

Pushbuttons

Illuminated PB

Programmable

Keylocks

Rotaries

Slides

Tactiles

Tilt

Touch

Indicators

Accessories

Supplement

AT4170
Spring Loaded Protective Guard
 Cover: Polycarbonate
 Base: Polyamide
 Coil spring: Stainless steel
 Series: KP UB2



AT4171
Spring Loaded Protective Guard
 Cover: Polycarbonate
 Base: Polyamide
 Coil spring: Stainless steel
 Series: LB UB



AT4172
Spring Loaded Protective Guard
 Cover: Polycarbonate
 Base: Polyamide
 Coil spring: Stainless steel
 Series: LB UB



AT4173
Spring Loaded Protective Guard
 Cover: Polycarbonate
 Base: Polyamide
 Coil spring: Stainless steel
 Series: UB



AT4174
Spring Loaded Protective Guard
 Cover: Polycarbonate
 Base: Polyamide
 Coil spring: Stainless steel
 Series: UB



AT4175
Spring Loaded Protective Guard
 Cover: Polycarbonate
 Base: Glass fiber reinforced polyamide
 Coil spring: Stainless steel
 Series: YB



AT4176
Square Cap for Bright LED
 Polycarbonate
 Colors: JB JC JD JF
 Series: LB



AT4177
Rectangular Cap for Bright LED
 Polycarbonate
 Colors: JB JC JD JF
 Series: LB



AT4178
Round Cap for Bright LED
 Polycarbonate
 Colors: JB JC JD JF
 Series: LB



AT4179
Round Cap for Bright LED
 Polycarbonate
 Colors: JB JC JD JF
 Series: LB Panel Seal



AT4180
Snap-on Knob
 Polyamide
 Knob: Black
 Flange: Transparent brown
 Series: FRO1



Color Codes: A Black B White C Red D Amber E Yellow F Green G Blue H Gray J Clear

AT4181

Splashproof Boot Assembly

Boot Material: Black silicon rubber
 Hex Nut Material & Finish: Nickel plated brass
 O-ring Material: Nitrile butadiene rubber
 Series: M P S WT



Switch Installation Instructions

1. Install switch bushing into mounting hole of panel from the back and adjust bushing to protrude 3.5 ~ 5.5mm (.138 ~ .217").
2. Install o-ring on bushing and tighten nut from above.
3. Insert boot onto nut. Be sure the boot and nut are a firm, secure fit.

For 12mm Bushings in M, P, S & WT Toggles

Boot & Nut Assembly Instructions

1. Stretch base of the boot to fit around outer edges of the nut.
2. The ridge inside of boot must be firmly seated in groove of the nut.
3. Moving all around perimeter, push (with about 10N of force) toward center to assure boot seals tightly into groove (with no air pockets).



Non-Splashproof Switches

M, P or S Toggles with 12mm Bushings



Use boot, nut and o-ring as shown. Use lockwasher and hexagon nut (from standard switch hardware) behind panel.

Splashproof Switches

S1AW ~ S29AW S Toggles

WT Toggle or M Toggle with B3 Bushing



Use boot, nut and o-ring as shown. Use o-ring only (from standard switch hardware) behind panel.

Series or Part Numbers	Panel Thickness (Maximum)
<ul style="list-style-type: none"> • M Series B2 Toggles with 12mm B1 & B3 Bushings • P Series B Toggles with 12mm Bushing • S31 ~ 39, S41 ~ 49, S31F ~ 33F, S41F ~ S43F, S31T ~ 33T, S41T ~ 43T • S301 ~ 309, S331 ~ 339, S301F ~ 333F, S335F, S301T ~ 309T, S331T ~ 339T • S421 ~ 429, S421T ~ 429 	5.0mm (.197")
<ul style="list-style-type: none"> • WT11S ~ 29S, WT11T ~ 29T, WT11L ~ 29L 	3.5mm (.138")
<ul style="list-style-type: none"> • S1A ~ 7A, S21A, S1F ~ 7F, S21F • S114, S116 • S1AW ~ 9AW, S21AW, S25AW ~ 29AW 	3.0mm (.118")

AT4188

Diffuser for AT4074

Square Cap
 Polycarbonate
 Color: B
 Series: UB



AT4189

Diffuser for AT4117

Rectangular Cap
 Polycarbonate
 Color: B
 Series: UB



Color Codes: A Black B White C Red D Amber E Yellow F Green G Blue H Gray J Clear

Accessories & Hardware

Toggle

Rockers

Pushbuttons

Illuminated PB

Programmable

Keylocks

Rotaries

Slides

Tactiles

Tilt

Touch

Indicators

Accessories

Supplement



AT9201
Bezel
 Polycarbonate
 Colors: A B C D E F G H
 Series: MLW



AT9410
Round Splash Cover
 Lid: Polyvinyl chloride
 Base: Polyethylene
 O-ring: Nitrile butadiene rubber
 Series: LB Panel Seal



AT9704-02YC
Socket for LCD 36 x 24
Single & Bicolor Pushbutton
 Base: Glass fiber reinforced PBT
 Terminals: Brass/beryllium copper
 Series: SmartSwitch



AT9704-065E
Socket for LCD 36 x 24
RGB Pushbutton
 Base: Glass fiber reinforced PBT
 Terminals: Brass/beryllium copper
 Series: SmartSwitch



AT9704-065F
Socket for LCD 36 x 24
Compact Pushbutton
 Base: Glass fiber reinforced PBT
 Terminals: Brass/beryllium copper
 Series: SmartSwitch

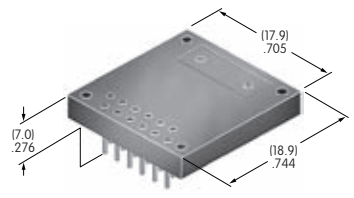

Note: By extracting some of the pins, socket may be used for the **64 x 32 Compact Pushbutton**

AT9704-085K
Socket for LCD 64 x 32 Pushbutton
 Base: Glass fiber reinforced PBT
 Terminals: Brass/beryllium copper
 Series: SmartSwitch



AT9704-085L
Socket for OLED 64 x 48 Pushbutton
 Base: Glass fiber reinforced PBT
 Terminals: Brass/beryllium copper
 Series: SmartSwitch



AT9704-085M
Socket for OLED 52 x 36 Display
 Base: Glass fiber reinforced PBT
 Terminals: Brass/beryllium copper
 Series: SmartSwitch



Color Codes: A Black B White C Red D Amber E Yellow F Green G Blue H Gray J Clear

Mouser Electronics

Authorized Distributor

Click to View Pricing, Inventory, Delivery & Lifecycle Information:

NKK Switches:

[AT082A](#) [AT448A](#) [AT448C](#) [AT456F](#) [AT529](#) [HK-1](#) [AT545](#) [AT3019P](#) [AT3010CF05JC](#) [AT438D](#) [AT4129Z](#) [AT438C](#)
[AT3010C05JB](#) [AT3011C02JA](#) [AT480FB](#) [AT716](#) [AT3011C12JB](#) [AT4054H](#) [AT3025JB](#) [AT501H/3](#) [AT485A/1](#)
[AT3011D24JA](#) [AT3017CB](#) [AT3069J04](#) [AT9201D](#) [AT3012CF24JF](#) [AT480CFA](#) [AT480CFC](#) [AT480DB](#) [AT3011C05JB](#)
[AT3011D05JB](#) [AT3011D12JA](#) [AT3011F05JF](#) [AT3012C02JB](#) [AT3012D12JE](#) [AT3010D24JA](#) [AT3010D24JB](#)
[AT3011CF05JB](#) [AT3010D05JB](#) [AT3010C02JB](#) [AT3010F24JA](#) [AT460E](#) [AT3010C12JA](#) [AT3010C02JF](#)
[AT3010C24JF](#) [AT3010D02JE](#) [AT3010CF05JB](#) [AT717](#) [AT3011CF12JF](#) [AT3070J01](#) [AT3069J02](#) [AT3010F24JF](#)
[AT3010F05JB](#) [AT4016FA](#) [AT480CA](#) [AT3011C12JC](#) [AT3011F12JB](#) [AT3011F12JF](#) [AT4016CC](#) [AT3011F02JA](#)
[AT207A/1](#) [AT4116A/1](#) [AT715-12](#) [AT3011C02JC](#) [AT719](#) [AT718](#) [AT401G](#) [AT3025CB](#) [AT3025EB](#) [AT3025FB](#)
[AT3069J06](#) [AT3011C02JB](#) [AT3010F05JE](#) [AT3070J02](#) [AT3010CF02JF](#) [AT3018JB](#) [AT062A/1](#) [AT208A/1](#)
[AT3070J04](#) [AT4016CFB](#) [AT480CE](#) [AT3069J05](#) [AT3012D24JC](#) [AT4016EC](#) [AT480CH](#) [AT4016EF](#) [AT4139C](#)
[AT4016CFA](#) [AT480CFB](#) [AT3012C05JB](#) [AT3012C12JC](#) [AT3012C02JC](#) [AT3012C05JC](#) [AT3012F24JC](#) [AT480DC](#)
[AT4016CF](#) [AT480CB](#) [AT3012D05JB](#) [AT3012F02JF](#) [AT4016CB](#)



Компания «ЭлектроПласт» предлагает заключение долгосрочных отношений при поставках импортных электронных компонентов на взаимовыгодных условиях!

Наши преимущества:

- Оперативные поставки широкого спектра электронных компонентов отечественного и импортного производства напрямую от производителей и с крупнейших мировых складов;
- Поставка более 17-ти миллионов наименований электронных компонентов;
- Поставка сложных, дефицитных, либо снятых с производства позиций;
- Оперативные сроки поставки под заказ (от 5 рабочих дней);
- Экспресс доставка в любую точку России;
- Техническая поддержка проекта, помощь в подборе аналогов, поставка прототипов;
- Система менеджмента качества сертифицирована по Международному стандарту ISO 9001;
- Лицензия ФСБ на осуществление работ с использованием сведений, составляющих государственную тайну;
- Поставка специализированных компонентов (Xilinx, Altera, Analog Devices, Intersil, Interpoint, Microsemi, Aeroflex, Peregrine, Syfer, Eurofarad, Texas Instrument, Miteq, Cobham, E2V, MA-COM, Hittite, Mini-Circuits, General Dynamics и др.);

Помимо этого, одним из направлений компании «ЭлектроПласт» является направление «Источники питания». Мы предлагаем Вам помощь Конструкторского отдела:

- Подбор оптимального решения, техническое обоснование при выборе компонента;
- Подбор аналогов;
- Консультации по применению компонента;
- Поставка образцов и прототипов;
- Техническая поддержка проекта;
- Защита от снятия компонента с производства.



Как с нами связаться

Телефон: 8 (812) 309 58 32 (многоканальный)

Факс: 8 (812) 320-02-42

Электронная почта: org@eplast1.ru

Адрес: 198099, г. Санкт-Петербург, ул. Калинина, дом 2, корпус 4, литера А.