



Is Now Part of



ON Semiconductor®

To learn more about ON Semiconductor, please visit our website at
www.onsemi.com

Please note: As part of the Fairchild Semiconductor integration, some of the Fairchild orderable part numbers will need to change in order to meet ON Semiconductor's system requirements. Since the ON Semiconductor product management systems do not have the ability to manage part nomenclature that utilizes an underscore (_), the underscore (_) in the Fairchild part numbers will be changed to a dash (-). This document may contain device numbers with an underscore (_). Please check the ON Semiconductor website to verify the updated device numbers. The most current and up-to-date ordering information can be found at www.onsemi.com. Please email any questions regarding the system integration to Fairchild_questions@onsemi.com.

ON Semiconductor and the ON Semiconductor logo are trademarks of Semiconductor Components Industries, LLC dba ON Semiconductor or its subsidiaries in the United States and/or other countries. ON Semiconductor owns the rights to a number of patents, trademarks, copyrights, trade secrets, and other intellectual property. A listing of ON Semiconductor's product/patent coverage may be accessed at www.onsemi.com/site/pdf/Patent-Marking.pdf. ON Semiconductor reserves the right to make changes without further notice to any products herein. ON Semiconductor makes no warranty, representation or guarantee regarding the suitability of its products for any particular purpose, nor does ON Semiconductor assume any liability arising out of the application or use of any product or circuit, and specifically disclaims any and all liability, including without limitation special, consequential or incidental damages. Buyer is responsible for its products and applications using ON Semiconductor products, including compliance with all laws, regulations and safety requirements or standards, regardless of any support or applications information provided by ON Semiconductor. "Typical" parameters which may be provided in ON Semiconductor data sheets and/or specifications can and do vary in different applications and actual performance may vary over time. All operating parameters, including "Typicals" must be validated for each customer application by customer's technical experts. ON Semiconductor does not convey any license under its patent rights nor the rights of others. ON Semiconductor products are not designed, intended, or authorized for use as a critical component in life support systems or any FDA Class 3 medical devices or medical devices with a same or similar classification in a foreign jurisdiction or any devices intended for implantation in the human body. Should Buyer purchase or use ON Semiconductor products for any such unintended or unauthorized application, Buyer shall indemnify and hold ON Semiconductor and its officers, employees, subsidiaries, affiliates, and distributors harmless against all claims, costs, damages, and expenses, and reasonable attorney fees arising out of, directly or indirectly, any claim of personal injury or death associated with such unintended or unauthorized use, even if such claim alleges that ON Semiconductor was negligent regarding the design or manufacture of the part. ON Semiconductor is an Equal Opportunity/Affirmative Action Employer. This literature is subject to all applicable copyright laws and is not for resale in any manner.

FAB3103

2.3 Watt Class-D Audio Amplifier with Integrated Boost Regulator and Automatic Gain Control

Features

- High Output, Low Distortion Class-D Mono Speaker Amplifier
 - 2.3W into 8Ω from 3.6V Supply (10% THD+N)
 - 1.85W into 8Ω from 3.6V Supply (1% THD+N)
 - 0.01% THD+N into 8Ω (100mW)
- High-Efficiency Boost Regulator Provides Higher Output Power Over Li-Ion Battery Voltages
 - 85% Total Efficiency (3.6V, 8Ω, P_O = 1.0W)
- Adaptive Boost Shutdown at Lower Output Power Increases Efficiency and Reduces Quiescent Current Consumption:
 - I_{DD} = 2.7mA from 3.6V Supply
- Automatic Gain Control (AGC) Monitors Battery Voltage and Dynamically Adjusts Gain, Extending Battery Runtime
- Reduced Noise Floor Enhances Audio Playback
 - 38μV Output Noise (A-Weighted)
 - 100dB SNR (A-Weighted)
- Low-EMI Design Allows Filterless Operation
- High-Power Supply Ripple Rejection:
 - 88dB PSRR (f_{ripple} = 217Hz, Boost Enabled)
 - 70dB PSRR (f_{ripple} = 217Hz, Boost Bypassed)
- High Noise Rejection Using Differential Audio Inputs:
 - 75dB CMRR (f_{in} = 1kHz)
 - 71dB CMRR (f_{in} = 217Hz)
- Short-Circuit Protection
- Under-Voltage Protection
- “Click and Pop” Suppression
- Available in 12-Bump, 0.5mm Pitch, WLCSP
 - Space-Saving 1.86mm x 1.44mm Package

Description

The FAB3103 is a mono Class-D audio amplifier with an integrated boost regulator that achieves high output audio over a power supply range of 2.5V to 5.2V.

Automatic Boost Shutdown dynamically shuts down the boost regulator at low output power for greater efficiency and lower quiescent current consumption.

Automatic Gain Control (AGC) monitors the battery and reduces gain as the battery voltage drops to limit maximum current consumption, extending battery runtime and preventing mobile device shutdown.

Applications

- Smart Phones, Feature Phones
- Tablets, Portable Gaming Devices
- GPS, Active Speakers

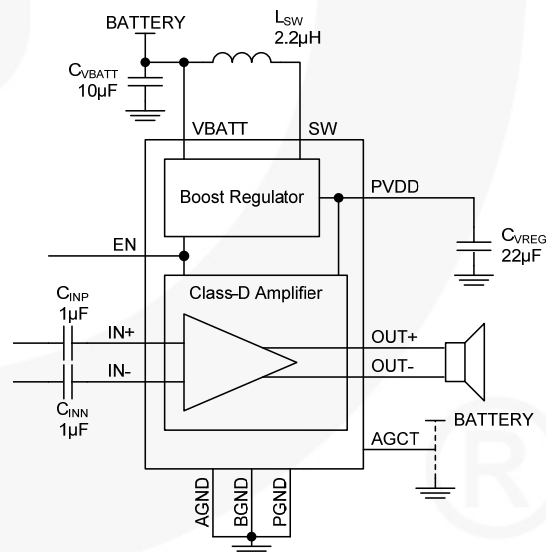

Figure 1. Typical Application Circuit

Ordering Information

Part Number	Operating Temperature Range	Package	Packing Method
FAB3103UCX	-40°C to +85°C	12-Bump, 0.5mm Pitch, Wafer-Level Chip-Scale Package (WLCSP)	3000 Units on Tape & Reel

Pin Configuration

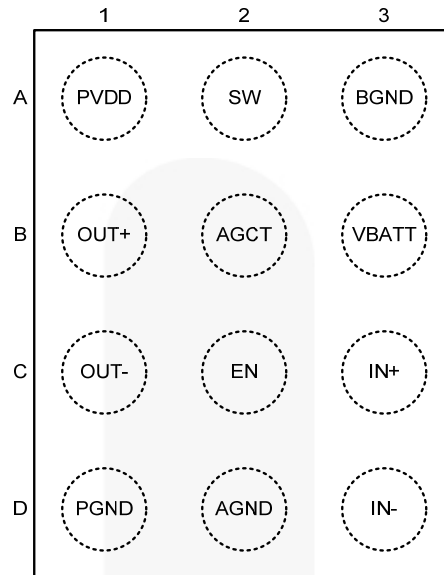

Figure 2. Pin Assignments (Top View)

Pin Definitions

WLCSP	Name	Type	Description
B1	OUT+	Output	Positive audio output
C1	OUT-	Output	Negative audio output
C3	IN+	Analog Input	Positive audio input
D3	IN-	Analog Input	Negative audio input
C2	EN	CMOS Input	Shutdown signal for boost regulator and amplifier: VBATT=enabled, PGND=shutdown (internal 300KΩ pull-down)
B2	AGCT	Analog Input	AGC trip-point setting
B3	VBATT	Power	Supply voltage
A2	SW	Power	Boost regulator switching node
A1	PVDD	Power	Boost regulator output
A3	BGND	Ground	Boost regulator ground – connect to PGND and AGND with a ground plane.
D1	PGND	Ground	Power ground – connect to BGND and AGND with a ground plane.
D2	AGND	Ground	Analog ground – connect to BGND and PGND with a ground plane.

Absolute Maximum Ratings

Stresses exceeding the absolute maximum ratings may damage the device. The device may not function or be operable above the recommended operating conditions and stressing the parts to these levels is not recommended. In addition, extended exposure to stresses above the recommended operating conditions may affect device reliability. The absolute maximum ratings are stress ratings only.

Symbol	Parameter	Min.	Max.	Unit
V _{BATT}	Voltage on VBATT Pin	-0.3	6.0	V
V _{OUT}	Voltage on OUT-, OUT+ Pins	-0.3	V _{BSTOUT} + 0.3	V
V _{IN}	Voltage on IN+, IN-, SW, EN, AGCT Pins	-0.3	V _{BATT} + 0.3	V
V _{INDIFF}	Differential Voltage Across IN+, IN- Pins While Enabled	-1.5	1.5	V _{rms}
P _D	Power Dissipation		Internally Limited	

Dissipation Ratings

Symbol	Parameter	Min.	Typ.	Max.	Unit
T _J	Junction Temperature			150	°C
T _{STG}	Storage Temperature Range	-65		150	°C
T _L	Lead Temperature (Soldering, 10s)			300	°C
Θ _{JA}	Thermal Resistance, JEDEC Standard, Multilayer Test Boards, Still Air		77		°C/W

Electrostatic Discharge Protection

Symbol	Parameter	Condition	Level	Unit
ESD	Human Body Model (HBM)	EIA/JESD22-A114	±3	KV
	Charged Device Model (CDM)	According to "EIA/JESD22-C101 Level III" Compatible with "IEC61340-3-3 Level C4" or "ESD-STM5.3.1-1999 Level C4"	±1	KV

Recommended Operating Conditions

The Recommended Operating Conditions table defines the conditions for actual device operation. Recommended operating conditions are specified to ensure optimal performance to the datasheet specifications. Fairchild does not recommend exceeding them or designing to Absolute Maximum Ratings.

Symbol	Parameter	Min.	Typ.	Max.	Unit
T _A	Operating Temperature Range	-40		85	°C
V _{BATT}	VBATT Supply Voltage Range	2.5		5.2	V
L _{SW}	Inductor (at Peak Inductor Current: 1.5A)	1.4 ⁽¹⁾	2.2		μH
C _{VBATT}	VBATT Capacitor	4.7 ⁽¹⁾	10.0		μF
C _{PVDD}	PVDD Capacitor	6.8 ⁽¹⁾	22.0		μF
C _{AGCT}	Capacitive Load on AGCT			10	pF
R _L	Load Resistance	6 ⁽²⁾	8		Ω

Notes:

- Capacitors experience degradation over time and this is accelerated with increased temperature. It is therefore recommended to use the stated typical values.
- The FAB3103 is optimized to drive an 8Ω speaker impedance. The 8Ω speaker should remain at ≥6Ω over the entire audio frequency range.

Electrical Characteristics

Unless otherwise noted: AGCT=GND, $R_L=8\Omega + 33\mu\text{H}$, $f=1\text{KHz}$, and audio measurement bandwidth=22Hz to 20KHz (AES17). Typical values are at $V_{\text{BATT}}=3.6\text{V}$, $T_A=25^\circ\text{C}$, with typical external component values.

Symbol	Parameter	Conditions		Min.	Typ.	Max.	Unit
I_{DD}	Quiescent Current	Inputs AC Grounded, EN=HIGH			2.7		mA
I_{SD}	Shutdown Current	EN=PGND, Inputs AC Grounded			0.1	2.0	μA
t_{WU}	Wake-Up Time	From LOW to HIGH EN Transition to Full Operation			5	12	ms
$f_{\text{SW(AMP)}}$	Class-D Switching Frequency				300		KHz
V_{OS}	Differential Output Offset Voltage	Inputs AC Grounded			1.67	5.00	mV
A_V	Gain	AGC Inactive		9.5	10.0	10.5	V/V
R_{IN}	Input Resistance	Gain=10V/V (AGC Inactive)	Differential	24	30	36	K Ω
			Single-Ended	12	15	18	
R_{STD}	Single-Ended Input Impedance During Shutdown	EN=PGND, AC-Coupled Inputs, $V_{\text{INx}} < 2V_{\text{rms}}$ per Input		80			K Ω
V_{STD}	Maximum Single-Ended Input Voltage Swing During Shutdown	EN=PGND, AC-Coupled Inputs		2			V_{rms}
	THD+N Added to Audio Signal at Inputs During Shutdown	EN=PGND, AC-Coupled Inputs, Source Impedance $< 1\Omega$				0.02	%
THD+N	Total Harmonic Distortion Plus Noise	$P_{\text{OUT}}=100\text{mW}$			0.01		%
		$P_{\text{OUT}}=500\text{mW}$			0.02		
P_{O}	Output Power	THD+N $\leq 10\%$			2.3		W
		THD+N $\leq 1\%$			1.85		
I_{DLMT}	Class-D Output Current Limit				1.4		A
PSRR	Power Supply Rejection Ratio	Inputs Shorted, AC Grounded, Output Referred; $V_{\text{RIPPLE}}=200\text{mV}_{\text{P-P}}$ Square Centered Around $V_{\text{BATT}}=3.8\text{V}$, 50% Duty Cycle, 10 μs Rise/Fall Time	$f_{\text{RIPPLE}}=1\text{KHz}$, Boost Enabled		85		dB
			$f_{\text{RIPPLE}}=217\text{Hz}$, Boost Enabled		88		
			$f_{\text{RIPPLE}}=1\text{KHz}$, Boost Bypassed		77		
			$f_{\text{RIPPLE}}=217\text{Hz}$, Boost Bypassed		70		
CMRR	Common-Mode Rejection Ratio	Output Referred, $V_{\text{RIPPLE}}=200\text{mV}_{\text{P-P}}$ Square, 50% Duty Cycle, 10 μs Rise/Fall Time, Inputs Shorted and AC-Coupled to V_{RIPPLE}	$f_{\text{RIPPLE}}=1\text{KHz}$		75		dB
			$f_{\text{RIPPLE}}=217\text{Hz}$		71		
V_{BIAS}	IN+, IN- Bias Voltage				1.2		V
η	Efficiency	$R_L=8\Omega + 33\mu\text{H}$, $P_{\text{OUT}}=1.0\text{W}$			85		%
SNR	Signal-To-Noise Ratio	$P_{\text{OUT}}=1.85\text{W}$, A-Weighted			100		dB
		$P_{\text{OUT}}=1.85\text{W}$, Unweighted			97		

Continued on the following page...

Electrical Characteristics

Unless otherwise noted: AGCT=GND, $R_L=8\Omega + 33\mu\text{H}$, $f=1\text{KHz}$, and audio measurement bandwidth=22Hz to 20KHz (AES17). Typical values are at $V_{\text{BATT}}=3.6\text{V}$, $T_A=25^\circ\text{C}$, with typical external component values.

Symbol	Parameter	Conditions	Min.	Typ.	Max.	Unit
e_n	Output Noise	A-Weighted		38		μV_{rms}
		Unweighted		51		
T_{STD}	Thermal Shutdown	Junction Temperature		165		$^\circ\text{C}$
T_{HYS}	Thermal Shutdown Hysteresis	Junction Temperature		25		$^\circ\text{C}$
V_{ULVO}	V_{BATT} Under-Voltage Shutdown		1.8	2.1	2.3	V
V_{HYS}	V_{BATT} Under-Voltage Hysteresis			120	300	mV
$f_{\text{SW(REG)}}$	Boost Converter Switching Frequency			1.2		MHz
$I_{\text{LIMIT(SU)}}$	Boost Converter Inrush Current Limit	PV_{DD} Rising from 0V to V_{BATT}			600	mA
t_{INRUSH}	Boost Converter Inrush Time	PV_{DD} Rising from 0V to V_{BATT}			1000	μs
	Auto Boost Startup Current Ramp Rate	PV_{DD} Rising from V_{BATT} to 5.6V		15		$\text{mA}/\mu\text{s}$
I_{BOOST}	Boost Converter Peak Input Current Limit	Open-Loop Limit	1100	1600	2100	mA
V_{BSTOUT}	Boost Converter Output Voltage		5.55	5.65	5.75	V
V_{BSTSTD}	Auto Boost Shutdown Threshold Voltage			2		V_{pk}
t_{HOLD}	Auto Boost Shutdown Hold Time			125		ms
V_{AGC}	AGC Trip Point	AGCT=Floating	3.190	3.250	3.283	V
		AGCT=GND	3.480	3.550	3.586	
		AGCT= V_{BATT}	3.680	3.750	3.788	
	Output Power with AGC	AGCT=GND, $V_{\text{IN}}=0.4V_{\text{pk}}$, 1KHz Sine Wave	$V_{\text{BATT}}=3.4\text{V}$	0.79		W
$V_{\text{BATT}}=3.0\text{V}$			0.45			
t_{A}	AGC Attack Time			20		$\mu\text{s}/\text{dB}$
t_{R}	AGC Release Time			1600		ms/dB
	AGC Step Size			0.5		dB
	AGC Maximum Attenuation			10		dB
V_{IH}	EN Logic Input High Voltage		1.1			V
V_{IL}	EN Logic Input Low Voltage				0.45	V
C_{IN}	EN Capacitance			10		pF
R_{PD}	EN Pull-Down Resistance			300		K Ω

Typical Performance Characteristics

Unless otherwise noted: AGCT = GND, $R_L = 8\Omega + 33\mu\text{H}$, $f = 1\text{KHz}$, audio measurement bandwidth 22Hz to 20KHz (AES17), $V_{\text{BATT}} = 3.6\text{V}$, $T_A = 25^\circ\text{C}$, typical external component values.

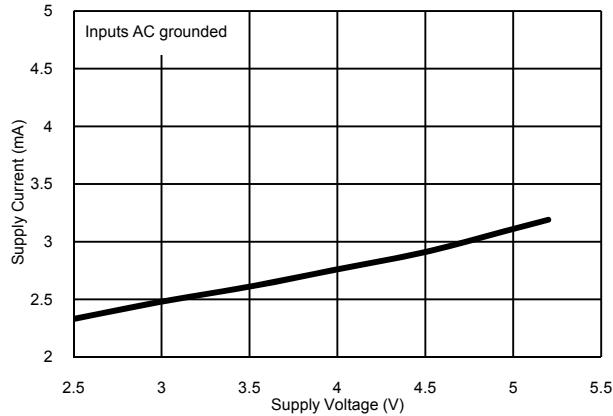

Figure 3. Quiescent Supply Current vs. Supply Voltage

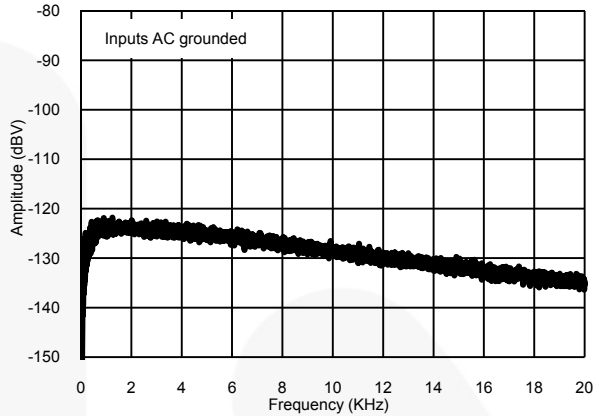

Figure 4. A-Weighted Output Noise vs. Frequency

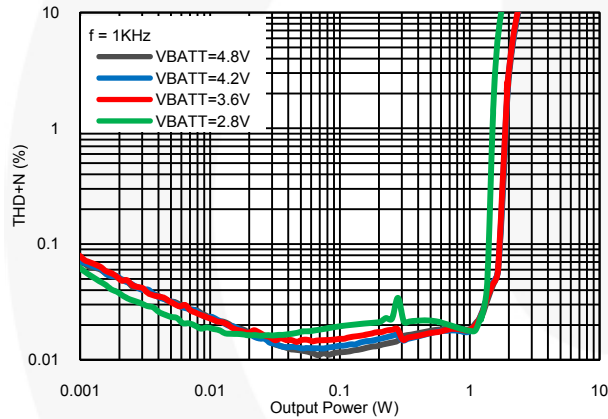

Figure 5. Total Harmonic Distortion + Noise vs. Output Power

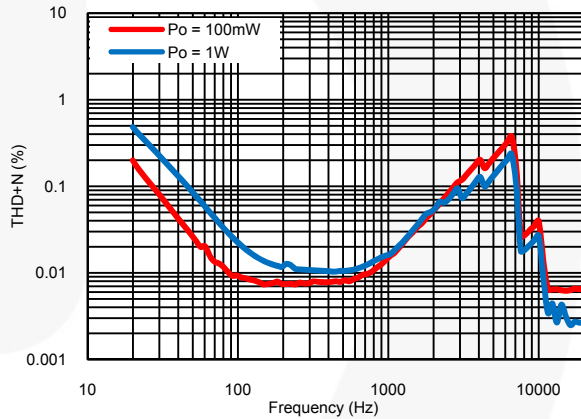

Figure 6. Total Harmonic Distortion + Noise vs. Frequency

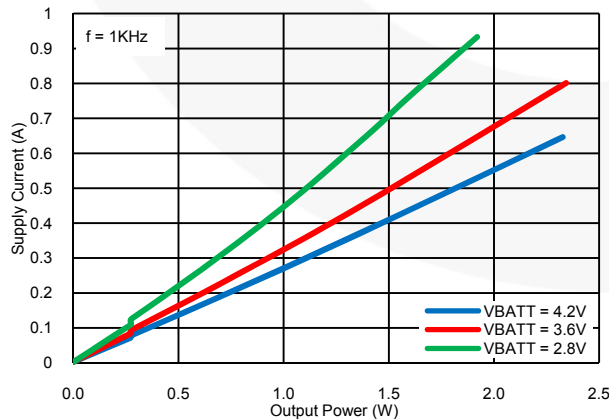

Figure 7. Supply Current vs. Output Power

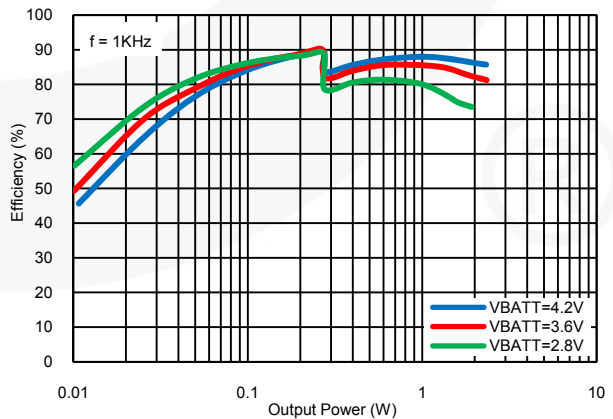

Figure 8. Efficiency vs. Output Power

Detailed Description

Signal Path

The FAB3103 features a fully differential signal path for noise rejection. The low-EMI design allows the OUT+ and OUT- pins to be connected directly to a speaker without an output filter.

The input section includes an 80KHz low-pass filter for removing out-of-band noise from audio sources, such as sigma delta DACs.

Shutdown

If EN is grounded, the Class-D amplifier and the boost regulator are turned off. IN+ and IN- are high impedance. Audio signals present at IN+ and IN- with amplitude less than the maximum differential input voltage swing are not distorted by the FAB3103 (see *Electrical Characteristics*).

When EN transitions from LOW to HIGH during the wake-up time (see *Electrical Characteristics*), the FAB3103 charges the input DC blocking capacitors to the Common Mode voltage before enabling the Class-D amplifier. To minimize click and pop during turn-on, audio signals should not be present during the wake-up period. Other devices that are connected to the same input signal, if not muted, may experience a pop due to this capacitor charging.

There is no limitation on the length of shutdown. Remaining charge on the PVDD capacitor at startup (for example, if EN is LOW for only a short period) does not affect startup behavior.

The EN pin has an internal 300K Ω pull-down resistor. EN must be LOW when V_{BATT} is lower than the V_{BATT} under-voltage shutdown voltage (see *Electrical Characteristics*). EN must remain LOW for at least 100 μ s after V_{BATT} rises above the V_{BATT} under-voltage shutdown voltage.

Class-D Amplifier Over-Current Protection

If the output current of the Class-D amplifier exceeds limits (see *the Electrical Characteristics*), the amplifier is disabled for approximately one second. (Other systems, such as the boost regulator and AGC, remain active.) After one second, the amplifier is re-enabled. If the fault condition still exists, the amplifier is disabled again. This cycle repeats until the fault condition is removed.

Speaker Size

The FAB3103 was designed for use with small speakers found in mobile applications. The back EMF in larger speakers can cause PVDD to peak above safe levels. To check safe operation, monitor PVDD while driving a dynamic signal (such as music) at maximum levels. If PVDD peaks above 6.2V, connect a 6V Zener diode between PVDD and PGND.

Low EMI

To minimize EMI, edge-rate control for the boost regulator and Class-D amplifier can be employed.

The boost regulator's edge-rate control is disabled by default. For devices with 20ns boost edge rates or 10ns boost edge rates, contact a Fairchild Representative. This is a factory option that cannot be changed in the application, but is available from Fairchild.

The Class-D amplifier's edge-rate control is disabled by default. For devices with 20ns Class-D edge rates, contact a Fairchild Representative. This is a factory option that cannot be changed in the application, but is available from Fairchild..

Automatic Boost Shutdown

Automatic boost shutdown changes the Class-D amplifier supply voltage as a function of audio output level. At audio output levels above $2V_{pk}$, the boost converter generates 5.65V from the input battery voltage. If the output level is below $2V_{pk}$ for more than 125ms, the boost converter is switched off and the Class-D amplifier is supplied directly from the battery. As a result, efficiency is improved at low audio output levels and quiescent current consumption is reduced.

Figure 9 shows an example of an auto boost startup event. At first, the boost converter is off and PVDD is the same voltage as VBATT. At 20 μ s, a large audio signal is presented at the inputs, which causes the boost converter to start up. From 20 μ s to 120 μ s, battery current is ramped up. The auto boost startup current ramp rate is 15mA/ μ s. This ramp is enforced to avoid sudden current draw spikes from the battery.

At 120 μ s, after PV_{DD} has reached the Boost Converter Output Voltage, the ramp is released and battery current falls to a level capable of sustaining the speaker amplifier's outputs. At 160 μ s, the input signal begins to rise, which increases battery current. At 180 μ s, the boost converter peak input current limit is enforced and battery current levels off, which causes PV_{DD} to droop.

The boost regulator should not be used to drive any loads other than the Class-D amplifier.

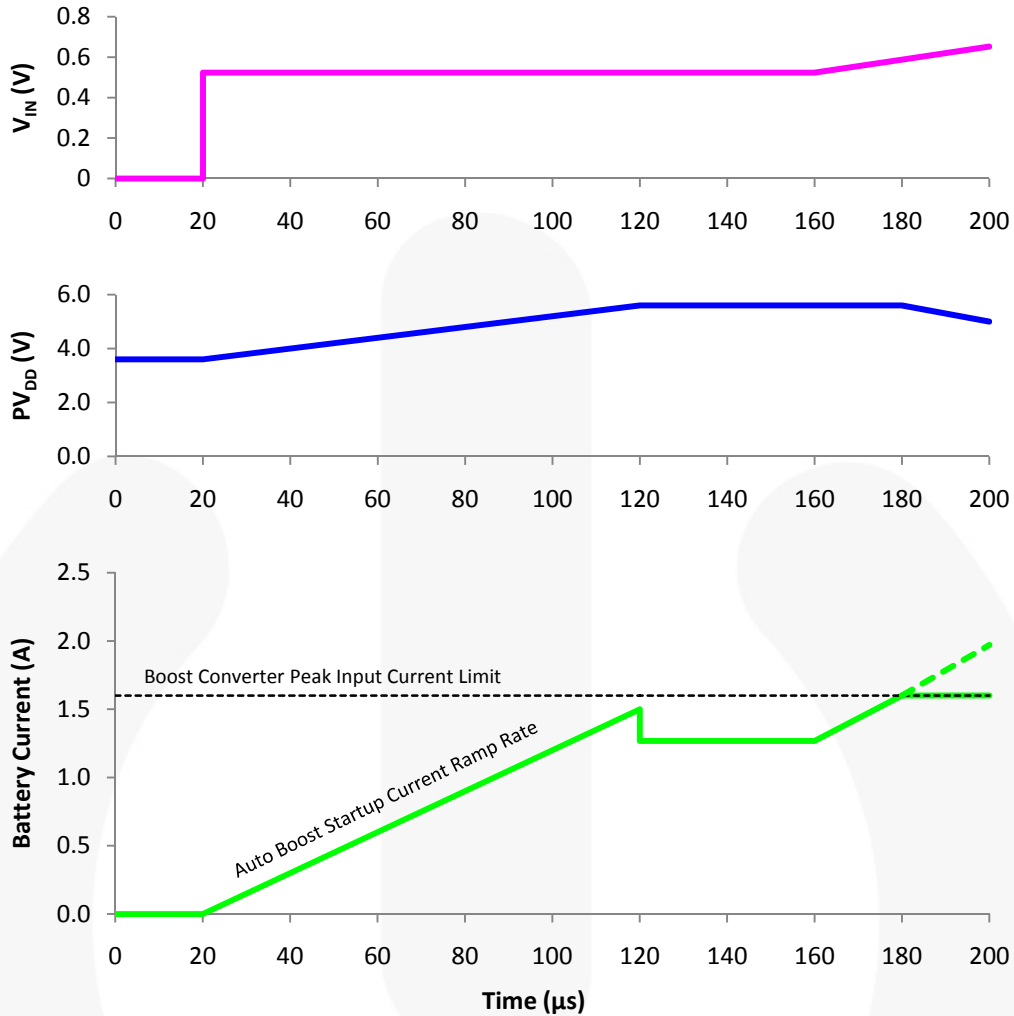

Figure 9. Auto Boost Startup

Automatic Gain Control

Due to constant output power, the amount of V_{BATT} current needed to maintain a given output amplitude is inversely proportional to V_{BATT} voltage. This produces very large current requirements at low V_{BATT} . The AGC eases low- V_{BATT} current demands by reducing the gain when V_{BATT} voltage drops below a trip point. One of three different trip points may be selected by shorting AGCT to V_{BATT} , shorting AGCT to PGND, or floating AGCT (see *Electrical Characteristics*).

The trip point is determined upon power-on and when EN transitions from LOW to HIGH. If AGCT is changed during operation, the new value is not read until power or EN is cycled.

When V_{BATT} is above the trip point, the AGC has no effect on the signal path.

When V_{BATT} is at or below the trip point, target gain is reduced in 0.5dB steps according to the equation:

$$G_{I\ arg\ et} = G_I - S_L G_I \left(\frac{V_T - V_{batt}}{V_{out\ max}} \right) \quad (1)$$

where:

- G_I = Initial gain (10V/V);
- S_L = 3V/V slope;
- V_{OUTMAX} = 5.2V;
- V_T = AGC trip point set by the AGCT pin; and
- V_{BATT} = Voltage at the V_{BATT} pin.

Target gain can be reduced by as much as 10dB.

Note that the state of auto boost shutdown has no effect on the AGC.

Figure 10 shows target gain vs. battery voltage.

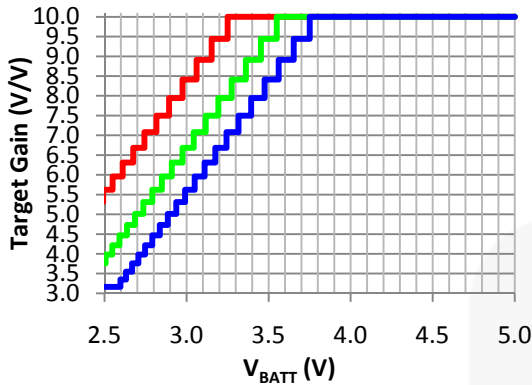

Line Color	AGCT Configuration	AGC Trip Point (V)
Red	Float	3.25
Green	Ground	3.55
Blue	V _{BATT}	3.75

Figure 10. Target Gain vs. Battery Voltage

Figure 11 is similar to Figure 10 except that the target gain is expressed in dB rather than V/V.

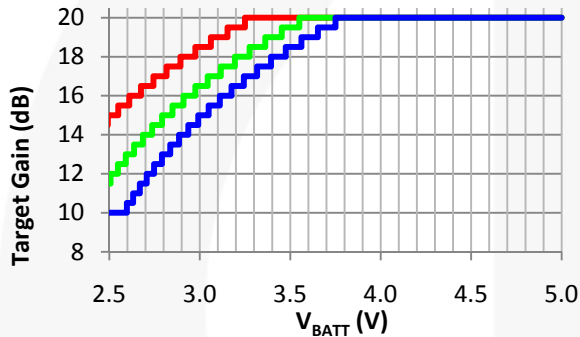

Line Color	AGCT Configuration	AGC Trip Point (V)
Red	Float	3.25
Green	Ground	3.55
Blue	V _{BATT}	3.75

Figure 11. Target Gain vs. Battery Voltage

Figure 12 shows examples of peak output voltage vs. battery voltage.

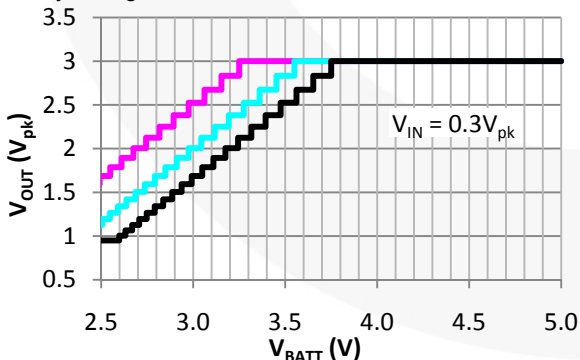

Line Color	AGCT Configuration	AGC Trip Point (V)	Input Voltage (V _{pk})
Magenta	Float	3.25	0.3
Cyan	Ground	3.55	0.3
Black	V _{BATT}	3.75	0.3

Figure 12. Output Voltage vs. Battery Voltage

Figure 13 shows examples of output power vs. battery voltage with a 0.4V_{pk} sinusoidal input signal.

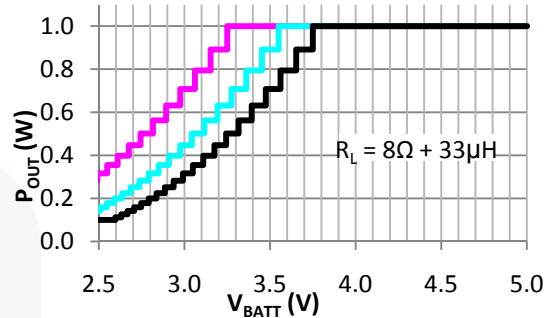

Line Color	AGCT Configuration	AGC Trip Point (V)	Input Voltage (V _{pk})
Magenta	Float	3.25	0.3
Cyan	Ground	3.55	0.3
Black	V _{BATT}	3.75	0.3

Figure 13. Output Power vs. Battery Voltage Examples (V_{IN}=0.4V_{pk} Sine)

The speed at which gain can change is limited (see *Electrical Characteristics*); therefore, the actual gain may lag the target gain if V_{BATT} voltage changes quickly.

Figure 14 and Figure 15 show examples of AGC changes over time. In these examples, AGCT is grounded, so the AGC trip point is 3.55V.

- Initially, V_{BATT} is 3.6V and gain is 10V/V (20dB).
- A narrow V_{BATT} drop of less than 2μs is ignored by the AGC.
- The next V_{BATT} drop lasts longer and the AGC is tripped. The initial 0.5dB gain reduction occurs 3.9μs after V_{BATT} crosses below the 3.55V trip point.
- V_{BATT} is now 3.1V, so target gain is 10V/V – 3V/V × 10V/V × [(3.55V – 3.1V) / 5.2V]=7.40V/V=17.4dB.
- Gain continues to drop by 0.5dB every 10μs until it is below the target gain, where it settles at 17.0dB.
- When V_{BATT} rises above the trip point, gain increases by 0.5dB. If more than 800ms has passed since the last gain change, gain rises immediately, as shown in Figure 14. Otherwise, gain does not rise until after 800ms has passed, as shown in Figure 15.
- While V_{BATT} remains above the trip point, gain continues to increase by 0.5dB every 800ms until it returns to 20dB.

The intent of the AGC circuitry is to limit current draw from the battery to extend runtime. This is particularly important for handsets that incorporate advanced shutdown algorithms to measure battery voltage. The AGC circuit dynamically adjusts the amplifier gain based on the trip point used. Even though the amplifier gain is reduced in response to lower battery voltages, two conditions result in continued higher current draw: 1) the handset volume is turned up in an attempt to maintain the same loudness, or 2) the input signal is increased. If

one or both of these conditions exist, even though the amplifier gain is reduced in response to lower battery

voltage, current draw remains elevated, eventually resulting in handset shutdown.

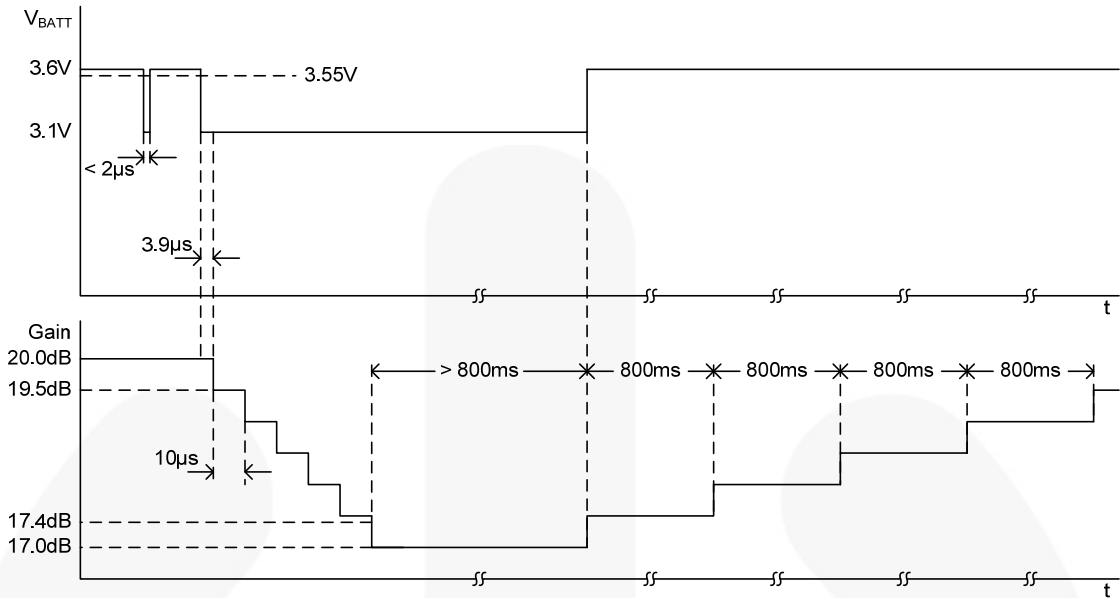

Figure 14. AGC Changes vs. Time, Example 1

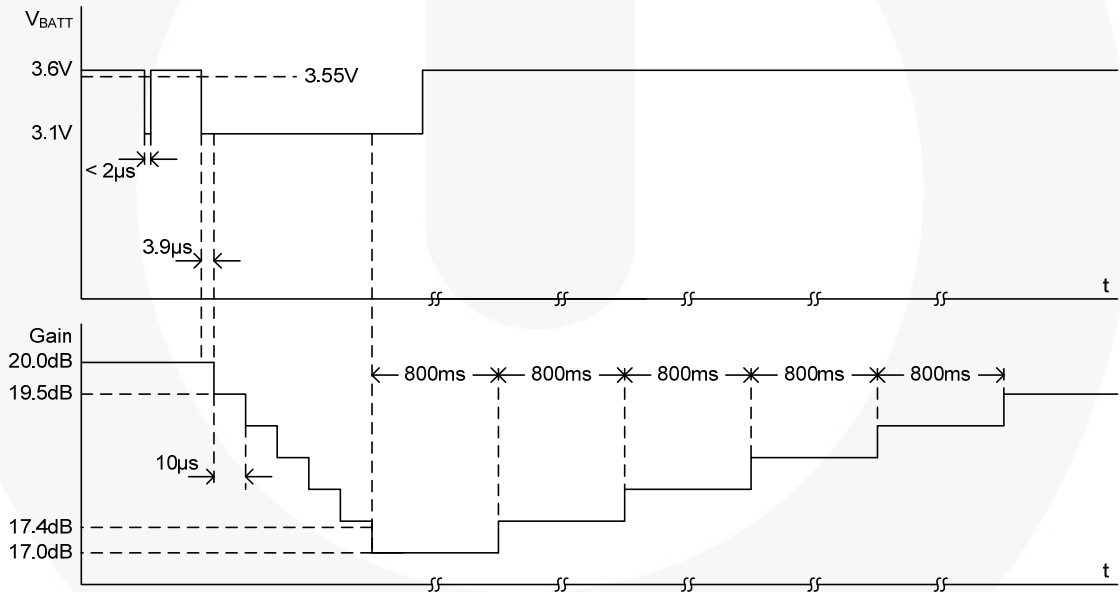

Figure 15. AGC Changes vs. Time, Example 2

Applications Information

Layout Considerations

General layout and supply bypassing play a major role in analog performance and thermal characteristics. Fairchild offers an evaluation board to guide layout and aid device evaluation. Contact a Fairchild representative for information about evaluation boards. Following the recommended layout configuration (shown in Figure 16) provides optimum performance for the device. For best results, follow the steps and recommended routing rules listed below.

Recommended Routing / Layout Rules

- Do not run analog and digital signals in parallel.
- Traces must run on top of the ground plane.
- Avoid routing at 90° angles.
- Place bypass capacitors within 2.54mm (0.1 inches) of the device power pin.
- Minimize all trace lengths to reduce series inductance.
- Connect BGND, PGND, and AGND together using a single ground plane.

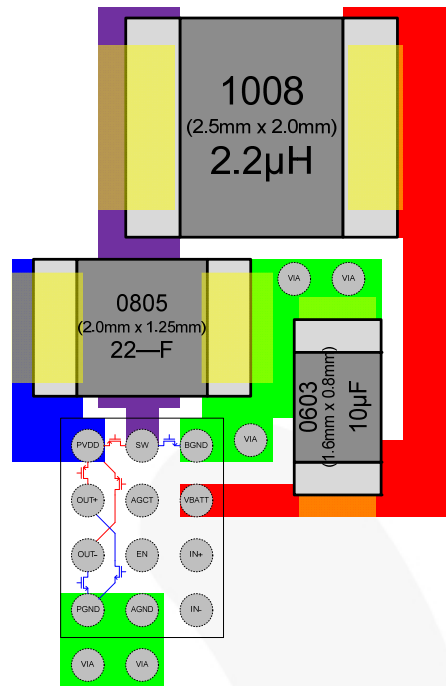

Figure 16. Recommended PCB Layout

Table 1 – Recommended Passive Components

Component	Vendor	Part Number	Value
L _{SW}	Murata	LQM2HPN2R2NJCL	2.2µH
C _{PVDD}	Murata	GRM21AR60J226UE80K	22µF
C _{VBATT}	Murata	GRM188R60J106UE82J	10µF

Physical Dimensions

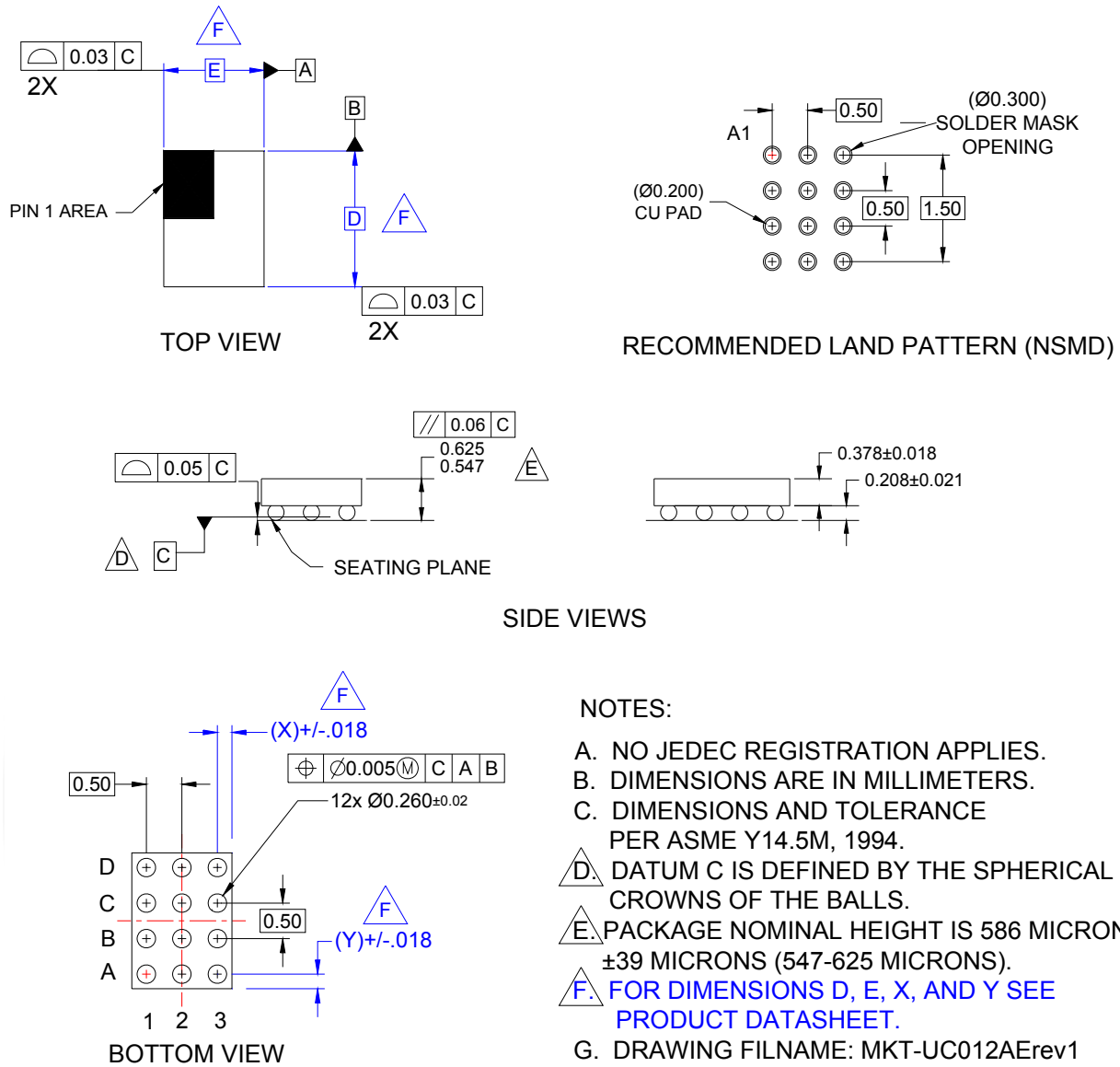

Figure 17. 12-Ball WLCSP, 3x4 Array, 0.5mm Pitch, 250 μ m Ball

Product Dimensions

Product	D	E	X	Y
FAB3103UCX	1.86mm	1.44mm	0.22mm	0.18mm

Package drawings are provided as a service to customers considering Fairchild components. Drawings may change in any manner without notice. Please note the revision and/or date on the drawing and contact a Fairchild Semiconductor representative to verify or obtain the most recent version. Package specifications do not expand Fairchild's worldwide terms and conditions, specifically the warranty therein, which covers Fairchild products.

Always visit Fairchild Semiconductors online packaging area for the most recent packaging drawings and tape and reel specifications. <http://www.fairchildsemi.com/packaging/>.



TRADEMARKS

The following includes registered and unregistered trademarks and service marks, owned by Fairchild Semiconductor and/or its global subsidiaries, and is not intended to be an exhaustive list of all such trademarks.

- | | | | |
|---|--|---|---|
| 2Cool™ | F-PFS™ | PowerTrench® | The Power Franchise® |
| AccuPower™ | FRFET® | PowerXS™ | the power franchise |
| AX-CAP™* | Global Power Resource™ | Programmable Active Droop™ | TinyBoost™ |
| BitSiC™ | GreenBridge™ | QFET® | TinyBuck™ |
| Build it Now™ | Green FPS™ | QS™ | TinyCalc™ |
| CorePLUS™ | Green FPS™ e-Series™ | Quiet Series™ | TinyLogic® |
| CorePOWER™ | Gmax™ | RapidConfigure™ | TINYOPTO™ |
| CROSSVOLT™ | GTO™ |  | TinyPower™ |
| CTL™ | IntelliMAX™ | Saving our world, 1mW/W/kW at a time™ | TinyPwm™ |
| Current Transfer Logic™ | ISOPLANAR™ | SignalWise™ | TinyWire™ |
| DEUXPEED® | Making Small Speakers Sound Louder and Better™ | SmartMax™ | TranSiC™ |
| Dual Cool™ | MegaBuck™ | SMART START™ | TriFault Detect™ |
| EcoSPARK® | MICROCOUPLER™ | Solutions for Your Success™ | TRUECURRENT®* |
| EfficientMax™ | MicroFET™ | SPM® | µSerDes™ |
| ESBC™ | MicroPak™ | STEALTH™ |  |
|  | MicroPak2™ | SuperFET® | UHC® |
| Fairchild® | MillerDrive™ | SuperSOT™-3 | Ultra FRFET™ |
| Fairchild Semiconductor® | MotionMax™ | SuperSOT™-6 | UniFET™ |
| FACT Quiet Series™ | mWSaver™ | SuperSOT™-8 | VCX™ |
| FACT® | OptoHi™ | SupreMOS® | VisualMax™ |
| FAST® | OPTOLOGIC® | SyncFET™ | VoltagePlus™ |
| FastvCore™ | OPTOPLANAR® | Sync-Lock™ | XS™ |
| FETBench™ | |  | |
| FlashWriter®* | | | |
| FPS™ | | | |

* Trademarks of System General Corporation, used under license by Fairchild Semiconductor.

DISCLAIMER

FAIRCHILD SEMICONDUCTOR RESERVES THE RIGHT TO MAKE CHANGES WITHOUT FURTHER NOTICE TO ANY PRODUCTS HEREIN TO IMPROVE RELIABILITY, FUNCTION, OR DESIGN. FAIRCHILD DOES NOT ASSUME ANY LIABILITY ARISING OUT OF THE APPLICATION OR USE OF ANY PRODUCT OR CIRCUIT DESCRIBED HEREIN; NEITHER DOES IT CONVEY ANY LICENSE UNDER ITS PATENT RIGHTS, NOR THE RIGHTS OF OTHERS. THESE SPECIFICATIONS DO NOT EXPAND THE TERMS OF FAIRCHILD'S WORLDWIDE TERMS AND CONDITIONS, SPECIFICALLY THE WARRANTY THEREIN, WHICH COVERS THESE PRODUCTS.

LIFE SUPPORT POLICY

FAIRCHILD'S PRODUCTS ARE NOT AUTHORIZED FOR USE AS CRITICAL COMPONENTS IN LIFE SUPPORT DEVICES OR SYSTEMS WITHOUT THE EXPRESS WRITTEN APPROVAL OF FAIRCHILD SEMICONDUCTOR CORPORATION.

As used herein:

1. Life support devices or systems are devices or systems which, (a) are intended for surgical implant into the body or (b) support or sustain life, and (c) whose failure to perform when properly used in accordance with instructions for use provided in the labeling, can be reasonably expected to result in a significant injury of the user.
2. A critical component in any component of a life support, device, or system whose failure to perform can be reasonably expected to cause the failure of the life support device or system, or to affect its safety or effectiveness.

ANTI-COUNTERFEITING POLICY

Fairchild Semiconductor Corporation's Anti-Counterfeiting Policy. Fairchild's Anti-Counterfeiting Policy is also stated on our external website, www.fairchildsemi.com, under Sales Support.

Counterfeiting of semiconductor parts is a growing problem in the industry. All manufacturers of semiconductor products are experiencing counterfeiting of their parts. Customers who inadvertently purchase counterfeit parts experience many problems such as loss of brand reputation, substandard performance, failed applications, and increased cost of production and manufacturing delays. Fairchild is taking strong measures to protect ourselves and our customers from the proliferation of counterfeit parts. Fairchild strongly encourages customers to purchase Fairchild parts either directly from Fairchild or from Authorized Fairchild Distributors who are listed by country on our web page cited above. Products customers buy either from Fairchild directly or from Authorized Fairchild Distributors are genuine parts, have full traceability, meet Fairchild's quality standards for handling and storage and provide access to Fairchild's full range of up-to-date technical and product information. Fairchild and our Authorized Distributors will stand behind all warranties and will appropriately address any warranty issues that may arise. Fairchild will not provide any warranty coverage or other assistance for parts bought from Unauthorized Sources. Fairchild is committed to combat this global problem and encourage our customers to do their part in stopping this practice by buying direct or from authorized distributors.

PRODUCT STATUS DEFINITIONS

Definition of Terms

Datasheet Identification	Product Status	Definition
Advance Information	Formative / In Design	Datasheet contains the design specifications for product development. Specifications may change in any manner without notice.
Preliminary	First Production	Datasheet contains preliminary data; supplementary data will be published at a later date. Fairchild Semiconductor reserves the right to make changes at any time without notice to improve design.
No Identification Needed	Full Production	Datasheet contains final specifications. Fairchild Semiconductor reserves the right to make changes at any time without notice to improve the design.
Obsolete	Not In Production	Datasheet contains specifications on a product that is discontinued by Fairchild Semiconductor. The datasheet is for reference information only.

Rev. I62

ON Semiconductor and  are trademarks of Semiconductor Components Industries, LLC dba ON Semiconductor or its subsidiaries in the United States and/or other countries. ON Semiconductor owns the rights to a number of patents, trademarks, copyrights, trade secrets, and other intellectual property. A listing of ON Semiconductor's product/patent coverage may be accessed at www.onsemi.com/site/pdf/Patent-Marking.pdf. ON Semiconductor reserves the right to make changes without further notice to any products herein. ON Semiconductor makes no warranty, representation or guarantee regarding the suitability of its products for any particular purpose, nor does ON Semiconductor assume any liability arising out of the application or use of any product or circuit, and specifically disclaims any and all liability, including without limitation special, consequential or incidental damages. Buyer is responsible for its products and applications using ON Semiconductor products, including compliance with all laws, regulations and safety requirements or standards, regardless of any support or applications information provided by ON Semiconductor. "Typical" parameters which may be provided in ON Semiconductor data sheets and/or specifications can and do vary in different applications and actual performance may vary over time. All operating parameters, including "Typicals" must be validated for each customer application by customer's technical experts. ON Semiconductor does not convey any license under its patent rights nor the rights of others. ON Semiconductor products are not designed, intended, or authorized for use as a critical component in life support systems or any FDA Class 3 medical devices or medical devices with a same or similar classification in a foreign jurisdiction or any devices intended for implantation in the human body. Should Buyer purchase or use ON Semiconductor products for any such unintended or unauthorized application, Buyer shall indemnify and hold ON Semiconductor and its officers, employees, subsidiaries, affiliates, and distributors harmless against all claims, costs, damages, and expenses, and reasonable attorney fees arising out of, directly or indirectly, any claim of personal injury or death associated with such unintended or unauthorized use, even if such claim alleges that ON Semiconductor was negligent regarding the design or manufacture of the part. ON Semiconductor is an Equal Opportunity/Affirmative Action Employer. This literature is subject to all applicable copyright laws and is not for resale in any manner.

PUBLICATION ORDERING INFORMATION

LITERATURE FULFILLMENT:

Literature Distribution Center for ON Semiconductor
19521 E. 32nd Pkwy, Aurora, Colorado 80011 USA
Phone: 303-675-2175 or 800-344-3860 Toll Free USA/Canada
Fax: 303-675-2176 or 800-344-3867 Toll Free USA/Canada
Email: orderlit@onsemi.com

N. American Technical Support: 800-282-9855 Toll Free
USA/Canada
Europe, Middle East and Africa Technical Support:
Phone: 421 33 790 2910
Japan Customer Focus Center
Phone: 81-3-5817-1050

ON Semiconductor Website: www.onsemi.com
Order Literature: <http://www.onsemi.com/orderlit>
For additional information, please contact your local
Sales Representative

Mouser Electronics

Authorized Distributor

Click to View Pricing, Inventory, Delivery & Lifecycle Information:

[ON Semiconductor:](#)

[FAB3103UCX](#)



Компания «ЭлектроПласт» предлагает заключение долгосрочных отношений при поставках импортных электронных компонентов на взаимовыгодных условиях!

Наши преимущества:

- Оперативные поставки широкого спектра электронных компонентов отечественного и импортного производства напрямую от производителей и с крупнейших мировых складов;
- Поставка более 17-ти миллионов наименований электронных компонентов;
- Поставка сложных, дефицитных, либо снятых с производства позиций;
- Оперативные сроки поставки под заказ (от 5 рабочих дней);
- Экспресс доставка в любую точку России;
- Техническая поддержка проекта, помощь в подборе аналогов, поставка прототипов;
- Система менеджмента качества сертифицирована по Международному стандарту ISO 9001;
- Лицензия ФСБ на осуществление работ с использованием сведений, составляющих государственную тайну;
- Поставка специализированных компонентов (Xilinx, Altera, Analog Devices, Intersil, Interpoint, Microsemi, Aeroflex, Peregrine, Syfer, Eurofarad, Texas Instrument, Miteq, Cobham, E2V, MA-COM, Hittite, Mini-Circuits, General Dynamics и др.);

Помимо этого, одним из направлений компании «ЭлектроПласт» является направление «Источники питания». Мы предлагаем Вам помощь Конструкторского отдела:

- Подбор оптимального решения, техническое обоснование при выборе компонента;
- Подбор аналогов;
- Консультации по применению компонента;
- Поставка образцов и прототипов;
- Техническая поддержка проекта;
- Защита от снятия компонента с производства.



Как с нами связаться

Телефон: 8 (812) 309 58 32 (многоканальный)

Факс: 8 (812) 320-02-42

Электронная почта: org@eplast1.ru

Адрес: 198099, г. Санкт-Петербург, ул. Калинина, дом 2, корпус 4, литера А.