

Stable Contact Reliability and Long Life

- Easy to mount, wire, and use.
- A large selection of models including various contact forms, DC-switching models, and open models.
- Mechanical life: 5,000,000 operations; electrical life (under rated load): 500,000 operations.
- Models also available with built-in diodes and for use as auxiliary power relays.

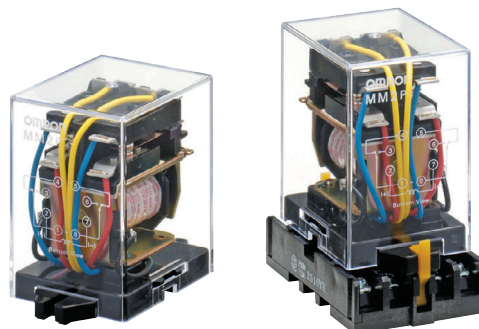

Refer to *Safety Precautions for All Relays*.

Ordering Information

Type	Contact form	Open structure		Cased
		Solder terminals	Screw terminals	Plug-in (octal pins) terminals
Standard	DPDT	MM2	MM2B	MM2P
	3PDT	MM3	MM3B	MM3P
	4PDT	MM4	MM4B	MM4P
DC-switching	DPDT	MM2X	MM2XB	MM2XP
	3PDT	MM3X	MM3XB	MM3XP
	4PDT	MM4X	MM4XB	MM4XP
With built-in diode	DPDT	---	---	MM2P-D
	4PDT	---	---	MM4P-D
DC-switching with built-in diode	DPDT	---	---	MM2XP-D
	4PDT	---	---	MM4XP-D
With operation indicator	DPDT	---	---	MM2PN
	3PDT	---	---	MM3PN
	4PDT	---	---	MM4PN
DC-switching with operation indicator	DPDT	---	---	MM2XPN
	3PDT	---	---	MM3XPN
	4PDT	---	---	MM4XPN
Conforming to auxiliary power relay specifications	4PDT	---	---	MM4P-JD
		---	---	MM4XP-JD

Available Models

Open Coils (with Solder Terminals)

Type	Contact form	Relay model	Available rated voltage
Standard	DP	MM2	6, 12, 24, 50, 100/(110), 200/(220) VAC 6, 12, 24, 48, 100/110, 200/220 VDC
	3P	MM3	100/(110), 200/(220) VAC 6, 12, 24, 48, 200/220 VDC
	4P	MM4	24, 100/(110), 200/(220) VAC 6, 12, 24, 48, 100/110, 200/220 VDC
DC-switching	DP	MM2X	100/(110), 200/(220) VAC 6, 12, 24, 48, 100/110, 200/220 VDC
	3P	MM3X	100/(110), 200/(220) VAC 12, 24, 100/110 VDC
	4P	MM4X	100/(110), 200/(220) VAC 12, 24, 48, 100/110 VDC

Open Coils (with Screw Terminals)

Type	Contact form	Relay model	Available rated voltage
Standard	DP	MM2B	6, 12, 24, 50, 100/(110), 200/(220) VAC 12, 24, 48, 100/110, 125, 200/220 VDC
	3P	MM3B	6, 100/(110), 200/(220) VAC 12, 24, 100/110 VDC
	4P	MM4B	6, 100/(110), 200/(220) VAC 12, 24, 48, 100/110 VDC
DC-switching	DP	MM2XB	24, 100/(110), 200/(220) VAC 12, 24, 48, 100/110, 125, 200/220 VDC
	3P	MM3XB	100/(110), 200/(220) VAC 12, 24, 48, 100/110, 125, 200/220 VDC
	4P	MM4XB	12, 24, 100/(110), 200/(220) VAC 6, 12, 24, 48, 100/110, 200/220 VDC

Cased Coils (Plug-in Terminals)

Type	Contact form	Relay model	Available rated voltage
Standard	DP	MM2P	6, 12, 24, 50, 100/(110), 200/(220) VAC 6, 12, 24, 48, 100/110, 125, 200/220 VDC
	3P	MM3P	6, 24, 100/(110), 200/(220) VAC 6, 12, 24, 48, 100/110, 125, 200/220 VDC
	4P	MM4P	6, 24, 50, 100/(110), 200/(220) VAC 12, 24, 48, 100/110, 125, 200/220 VDC
DC-switching	DP	MM2XP	6, 24, 100/(110), 125, 200/(220) VAC 6, 12, 24, 48, 100/110, 125, 200/220 VDC
	3P	MM3XP	24, 50, 100/(110), 200/(220) VAC 12, 24, 48, 100/110, 125, 200/220 VDC
	4P	MM4XP	12, 24, 50, 100/(110), 200/(220) VAC 6, 12, 24, 48, 100/110, 125, 200/220 VDC
With built-in diode	DP	MM2P-D MM4P-D	12, 24, 48, 100/110, 200/220 VDC 12, 24, 48, 100/110, 125, 200/220 VDC
DC-switching with built-in diode	DP	MM2XP-D MM4XP-D	12, 24, 48, 100/110, 125, 200/220 VDC 12, 24, 48, 100/110, 125, 200/220 VDC
With operation indicator	DP	MM2PN	6, 24, 100/(110), 200/(220) VAC 6, 12, 24, 48, 100/110, 125, 200/220 VDC
	3P	MM3PN	100/(110), 200/(220) VAC 6, 12, 24, 48, 100/110, 200/220 VDC
	4P	MM4PN	24, 100/(110), 200/(220) VAC 24, 48, 100/110, 125, 200/220 VDC
DC-switching with operation indicator	DP	MM2XPN	100/(110), 200/(220) VAC 12, 24, 48, 100/110, 125, 200/220 VDC
	3P	MM3XPN	100/(110), 200/(220) VAC 24, 48, 100/110, 200/220 VDC
	4P	MM4XPN	100/(110), 200/(220) VAC 12, 24, 48, 100/110, 125, 200/220 VDC
Conforming to auxiliary power relay specifications	4P	MM4P-JD	100/(110), 110, 115, 200/(220), 220 VAC 24, 100/110, 125, 200/220 VDC
Conforming to auxiliary power relay specifications for DC-switching	4P	MM4XP-JD	100/(110), 110, 115, 200/(220) VAC 24, 48, 100/110, 125, 200/220 VDC

Models Conforming to Auxiliary Power Relay Specifications

The MM4P-JD and MM4XP-JD satisfy the ratings of auxiliary relays provided in JEC-2500 (1987) standards for power protective relays specified by the Japan Electromechanical Commission. Furthermore, the MM4P-JD and MM4XP-JD satisfy the ratings of multi-contact relays provided in JEC-174D (1979) standards for power auxiliary relays.

These models work at operation level B specified by JEC-174D (1979) standards and the hot start of the relays is possible after the coils radiate heat.

In accordance with JEC-2500 (1987) standards, the coil of each model withstands a 130% DC load or 115% AC load.

Note: 1. When ordering, add the rated coil voltage to the model number. Rated coil voltages are given in the coil ratings table.

Example: MM2, 6 VAC

Rated coil voltage

2. Latching Relays based on the MM Series are also available. Refer to the MMK.

3. Models with built-in varistors (AC operation) are also available in addition to those with built-in diodes. Ask your OMRON representative for details.

Model Number Legend

MM□□□□-□
 1 2 3 4 5

1. Contact Form

- 2: DPDT
- 3: 3PDT
- 4: 4PDT

2. Type (See Note.)

- None: Standard
- X: DC-switching

3. Terminal Shape

- None: Solder
- B: Screw
- P: Plug-in

4. Operation Indicator

- None: Not provided
- N: Provided

5. Built-in Diode

- None: Not provided
- D: Provided



Note: The suffix "JD" indicates models conforming to auxiliary power relay specifications.

■ Accessories (Order Separately)

Mounting Brackets

Mounting Bracket (S bracket)	R99-03MM
------------------------------	----------

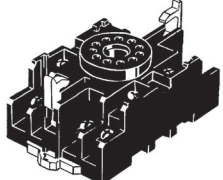
Sockets

Relay model	DIN Track/Front-connecting Socket (screw terminals)	Back-connecting Socket (solder terminals)
MM2(X)P(-D)	8PFA	PL08
MM3P	11PFA 	PL11 
MM3XP, MM4(X)P(-D)	14PFA	PL15
MM4(X)P-JD	14PFA	---

Specifications

■ Coil Ratings

Open Coils (with Solder or Screw Terminals)

Rated voltage (V)	Rated current (mA)				Coil resistance (Ω)		Must-operate voltage	Must-release voltage	Max. voltage	Power consumption (VA or W)		
	DP		3P or 4P		DP	3P or 4P				Initial	Rated	
	50 Hz	60 Hz	50 Hz	60 Hz			% of rated voltage					
AC	6	790	655	1,120	950	1.1	0.5	80% max.	30% min. (60 Hz) 25% min. (50 Hz)	110%	Approx. 4.1 (DP) Approx. 6.3 (3P or 4P)	Approx. 3.5 (DP) Approx. 5.1 (3P or 4P)
	12	395	325	560	480	4.7	2.0					
	24	195	160	280	240	19	8.5					
	50	94	78	134	114	82	36					
	100/(110)	47	39/45	67	57/66	340	150					
	200/(220)	23.5	19.5/ 22.5	33.5	28.5/33	1,540	620					
DC	6	340		450		17.5	13.4	70% max.	10% min.		Approx. 2.1 (DP) Approx. 2.7 (3P or 4P)	
	12	176		220		68	54					
	24	87		94		275	255					
	48	41		52		1,180	930					
	100/110	17/19		22/24.5		5,750	4,500					
	200/220	8.6/9.5		11/12		23,200	18,000					

- Note:**
- The rated current and coil resistance are measured at a coil temperature of 23°C with tolerances of +15%/–20% for AC rated current and ±15% for DC coil resistance.
 - The AC coil resistance values are reference values.
 - Performance characteristic data are measured at a coil temperature of 23°C.
 - The maximum voltage is one that is applicable instantaneously to the Relay coil at an ambient temperature of 23°C and not continuously.

Cased Coils (Plug-in Terminals)

The rated current may vary if the Relay has a built-in operating indicator (See note 4.).

Rated voltage (V)	Rated current (mA)				Coil resistance (Ω)		Coil inductance (H)				Must-operate voltage	Must-release voltage	Max. voltage	Power consumption (VA or W)		
	DP		3P or 4P		DP	3P or 4P	DP		3P or 4P					Initial	Rated	
	50 Hz	60 Hz	50 Hz	60 Hz			Contact release	Contact operate	Contact release	Contact operate	% of rated voltage					
AC	6	690	590	975	850	1.1	0.5	0.02	0.02	0.01	0.03	80% max.	30% min. (60 Hz) 25% min. (50 Hz)	110%	Approx. 4.1 (DP) Approx. 6.3 (3P or 4P)	Approx. 3.5 (DP) Approx. 5.1 (3P or 4P)
	12	345	295	490	430	4.7	2.0	0.07	0.01	0.04	0.07					
	24	170	145	245	210	19	8.5	0.28	0.41	0.18	0.28					
	50	82	70	117	102	82	36	1.2	1.7	0.75	1.2					
	100/(110)	41	35/40	58.5	51/58	340	150	4.8	6.7	3	4.5					
	200/(220)	20.5	17.5/ 20	29	25.5/ 29	1,540	620	20	25.6	12	19					
DC	6	340		450		17.5	13.4	0.2	0.36	0.23	0.35	70% max.	10% min.		Approx. 2.1 (DP) Approx. 2.7 (3P or 4P)	
	12	176		220		68	54	0.74	1.0	0.87	1.4					
	24	87		94		275	255	4.2	5.8	5.6	9.2					
	48	41		52		1,180	930	20.4	26	27.3	45.5					
	100/110	17/19		22/24.5		5,750	4,500	81.6	92.5	61.4	96.5					
	200/220	8.6/9.5		11/12		23,200	18,000	340	380	158	250					

- Note:**
- The rated current and coil resistance are measured at a coil temperature of 23°C with tolerances of +15%/–20% for AC rated current and ±15% for DC coil resistance.
 - The AC coil resistance and coil inductance values are for reference only.
 - Performance characteristic data are measured at a coil temperature of 23°C.
 - The maximum voltage is one that is applicable instantaneously to the Relay coil at an ambient temperature of 23°C and not continuously.
 - The rated current of a model with a built-in LED indicator at 6, 12, 24, or 50 VAC or 6, 12, 24, or 48 VDC increases by approx. 10 mA due to the current consumption of the LED. The rated current of a model with a built-in neon lamp indicator at 100/(110) or 200/(220) VAC or 100/110 or 200/220 VDC increases by approx. 0.2 mA due to the current consumption of the neon lamp.

Coils (Conforming to Auxiliary Power Relay Specifications)

	Rated voltage (V)	Rated current (mA)		Coil resistance (Ω)	Coil inductance (H)		Must-operate voltage	Must-release voltage	Max. voltage	Operation level (JEC-174D)	Power consumption (VA or W)	
		50 Hz	60 Hz		Contact release	Contact operate					% of rated voltage	
AC	24	245	210	8.5	0.18	0.28	80% max.	30% min. (60 Hz) 25% min. (50 Hz)	110%	B Hot start after coil heated	Approx. 6.3	Approx. 5.1
	50	117	102	36	0.75	1.2						
	100/(110)	58.5	51/58	150	3	4.5						
	110	53	46	182	3.6	5.5						
	115	51	44	210	4	6.2						
	200/(220)	29	25.5/29	620	12	19						
	220	26.5	23	780	15	21						
DC	24	94		255	5.6	9.2	70% max.	10% min.			Approx. 2.7	
	48	52		930	27.3	45.5						
	100/110	22/24.5		4,500	61.4	96.5						
	125	22		5,800	90	130						
	200/220	11/12		18,000	158	250						

- Note:** 1. The rated current and coil resistance are measured at a coil temperature of 23°C with tolerances of +15%/–20% for AC rated current and $\pm 15\%$ for DC coil resistance.
 2. The AC coil resistance and coil inductance values are for reference only.
 3. Performance characteristic data are measured at a coil temperature of 23°C.
 4. The maximum voltage is one that is applicable instantaneously to the Relay coil at 23°C and not continuously.

Contact Ratings

Standard Relays

Item	Open Relays		Cased Relays	
	MM2(B), MM3(B), MM4(B)		MM2P(N, -D), MM3P(N), MM4P(N, -D)	
	Resistive load ($\cos\phi = 1$)	Inductive load ($\cos\phi=0.4, L/R=7$ ms)	Resistive load ($\cos\phi = 1$)	Inductive load ($\cos\phi=0.4, L/R=7$ ms)
Contact type	Single			
Contact material	Ag			
Rated load	15 A at 220 VAC 10 A at 24 VDC		7.5 A at 220 VAC 5 A at 24 VDC	
Rated carry current	15 A		7.5 A	
Max. switching voltage	250 VAC, 250 VDC		250 VAC, 250 VDC	
Max. switching current	15 A		7.5 A	
Max. switching power (reference value)	3,300 VA at 240 W		1,700 VA at 120 W	
Minimum permissible load (reference value) (See note.)	5 VDC 10 mA			

Note: This value is measured at 60 operations/min.

DC-switching Relays/Built-in Diode Relays

Item	Open Relays		Cased Relays	
	MM2X(B), MM3X(B), MM4X(B)		MM2XP(-D), MM3XP, MM4XP(-D)	
	Resistive load ($\cos\phi = 1$)	Inductive load ($L/R=7$ ms)	Resistive load ($\cos\phi = 1$)	Inductive load ($L/R=7$ ms)
Contact type	Single			
Contact material	Ag			
Rated load	10 A at 110 VDC	7 A at 110 VDC	7 A at 110 VDC	6 A at 110 VDC
Rated carry current	15 A		7.5 A	
Max. switching voltage	250 VAC, 250 VDC		250 VAC, 250 VDC	
Max. switching current	15 A		7.5 A	
Max. switching power (reference value)	1,200 W at 20 VA	800 W at 20 VA	800 W at 20 VA	660 W at 20 VA
Minimum permissible load (reference value) (See note 3.)	5 VDC at 10 mA			

- Note:** 1. When switching DC inductive loads at 125 V or more, an unstable region exists for a contact current of between 0.5 and 2.5 A. The Relay will not turn OFF in this region. Use a contact current of 0.5 A or less when switching 125 VDC or more.
 2. If L/R exceeds 7 ms when switching DC inductive loads, an arc-breaking time of up to 50 ms must be considered in application and the circuit must be designed to ensure that an arc-breaking time of 50 ms is not exceeded.
 3. This value is measured at 60 operations/min.

Contacts (Conforming to Auxiliary Power Relay Specifications)

Item	MM4P-JD		MM4XP-JD	
	Resistive load	Inductive load ($\cos\phi = 0.4$, L/R = 7 ms)	Resistive load	Inductive load ($\cos\phi = 0.4$, L/R = 7 ms)
Contact type	Single			
Contact material	Ag			
Rated load	5 A at 220 VAC, 5 A at 24 VDC		5 A at 110 VDC	
Rated carry current	5 A			
Max. switching voltage	250 VAC, 250 VDC			
Max. switching current	5 A			
Max. switching power (reference value)	1,100 VA, 120 W, 30 W (L/R = 40 ms)		20 VA, 550 W, 40 W (L/R = 40 ms)	

- Note:** 1. A model for DC loads is not in stable operation when switching an inductive load within a operating current range between 0.5 and 2.5 A at a minimum of 125 VDC, where the load cannot be switched.
2. If L/R exceeds 7 ms when switching DC inductive loads, an arc-breaking time of up to 50 ms must be considered in application and the circuit must be designed to ensure that an arc-breaking time of 50 ms is not exceeded.

■ Characteristics

Standard Relays

Item	Open Relays	Cased Relays
Contact resistance (See note 2.)	25 mΩ max.	50 mΩ max.
Operate time (See note 3.)	AC: 25 ms max. DC: 50 ms max.	
Release time (See note 3.)	30 ms max. (100 ms max. for Built-in Diode Relays)	
Max. operating frequency	Mechanical: 7,200 operations/hr Electrical: 1,800 operations/hr (under rated load)	
Insulation resistance (See note 4.)	100 MΩ min. (at 500 VDC)	
Dielectric strength	1,500 VAC, 50/60 Hz for 1 min between contacts of same polarity 2,000 VAC, 50/60 Hz for 1 min between contacts of different polarity (and between coil and contacts)	
Vibration resistance	Destruction: 10 to 55 to 10 Hz, 0.75 mm single amplitude (1.5 mm double amplitude) Malfunction: 10 to 50 to 10 Hz, 0.5 mm single amplitude (1.0 mm double amplitude)	
Shock resistance	Destruction: 1,000 m/s ² Malfunction: 100 m/s ²	
Endurance	Mechanical: 5,000,000 operations min. (at 7,200 operations/hr) Electrical: 500,000 operations min. (at 1,800 operations/hr under rated load) (See note 5.)	
Ambient temperature	Operating: -10°C to 55°C (with no icing or condensation)	
Ambient humidity	Operating: 5% to 85%	
Weight	Standard models: DC-switching models MM2 approx. 160 g MM2X approx. 165 g MM2XP approx. 225 g MM3 approx. 270 g MM3X approx. 275 g MM3XP approx. 395 g MM4 approx. 300 g MM4X approx. 310 g MM4XP approx. 420 g MM2P approx. 220 g MM3P approx. 360 g MM4P approx. 410 g	

- Note:** 1. The data shown above are initial values.
2. The contact resistance was measured with 1 A at 5 VDC using the voltage drop method.
3. The operate or release time was measured with the rated voltage imposed with any contact bounce ignored at an ambient temperature of 23°C.
4. The insulation resistance was measured with a 500-VDC megger applied to the same places as those used for checking the dielectric strength.
5. The electrical endurance was measured at an ambient temperature of 23°C.

Relays (Conforming to Auxiliary Power Relay Specifications)

Item	Cased Relays
Contact resistance (See note 2.)	50 mΩ max.
Operate time (See note 3.)	AC: 25 ms max., DC: 50 ms max.
Release time (See note 3.)	30 ms max.
Max. operating frequency	Mechanical: 1,800 operations/hr Electrical: 1,800 operations/hr (under rated load)
Insulation resistance (See note 4.)	100 MΩ min.
Dielectric strength	Between coil and contact: 2,000 VAC, 50/60 Hz for 1 minute Between contacts of different polarity: 2,000 VAC, 50/60 Hz for 1 minute Between contacts of same polarity: 1,500 VAC, 50/60 Hz for 1 minute
Vibration resistance	Destruction: 10 to 55 to 10 Hz, 0.75 mm single amplitude (1.5 mm double amplitude) Malfunction: 10 to 22 to 10 Hz, 0.5 mm single amplitude (1.0 mm double amplitude)
Shock resistance	Destruction: 300 m/s ² Malfunction: 30 m/s ²
Endurance	Mechanical: 5,000,000 operations min. (at 1,800 operations/hr) Electrical: 500,000 operations min. (at 1,800 operations/hr with rated load) (see note 5)
Error rate (level P) (Reference value) (See note 6.)	10 mA at 5 VDC
Ambient temperature	Operating: -10°C to 40°C (with no icing or condensation)
Ambient humidity	Operating: 5% to 85%
Weight	MM4P-JD: approx. 410 g MM4XP-JD: approx. 420 g

- Note:**
- The data shown above are initial values.
 - The contact resistance was measured with 1 A at 5 VDC using the voltage drop method.
 - The operate or release time was measured with the rated voltage imposed with any contact bounce ignored at an ambient temperature of 23°C.
 - The insulation resistance was measured with a 500-VDC megger applied to the same places as those used for checking the dielectric strength.
 - The electrical endurance was measured at an ambient temperature of 23°C.
 - This value was measured at a switching frequency of 60 operations per minute.

Engineering Data

Standard Relays

Maximum Switching Power Open Relays

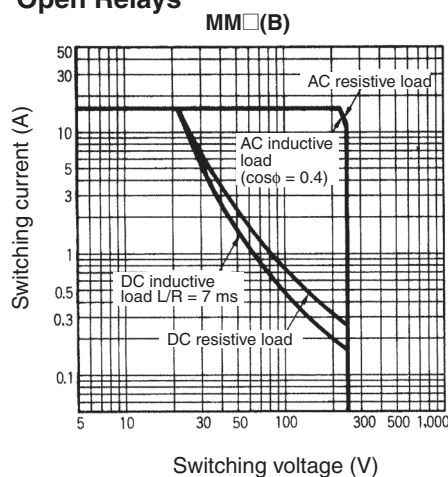

Cased Relays

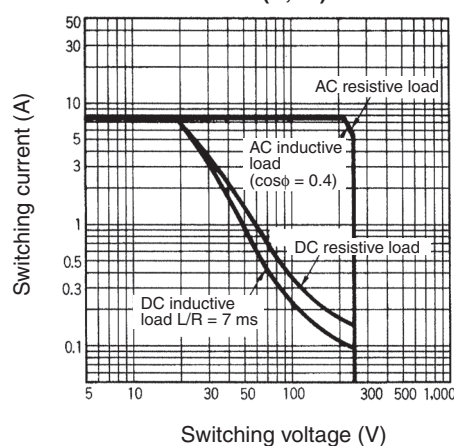

Endurance Curves

Open Relays

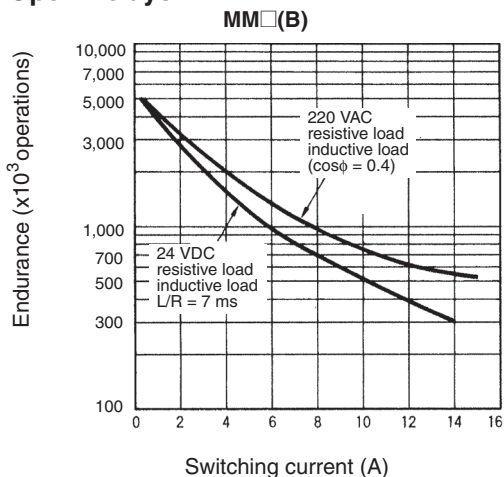

Cased Relays

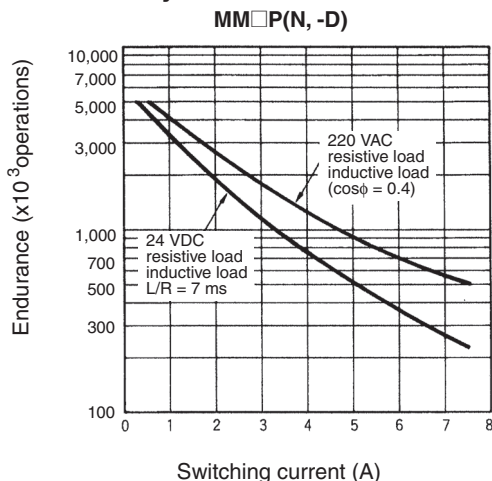

DC-switching Relays

Maximum Switching Power
Open Relays

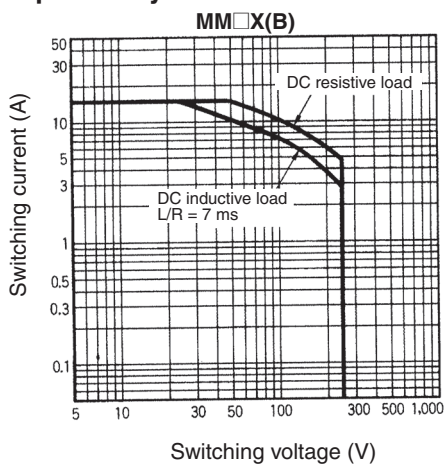

Cased Relays

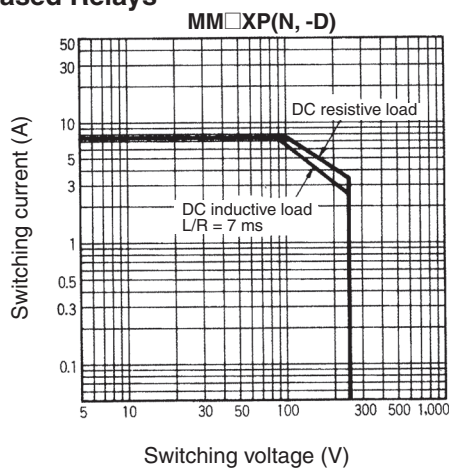

Endurance Curves

Open Relays

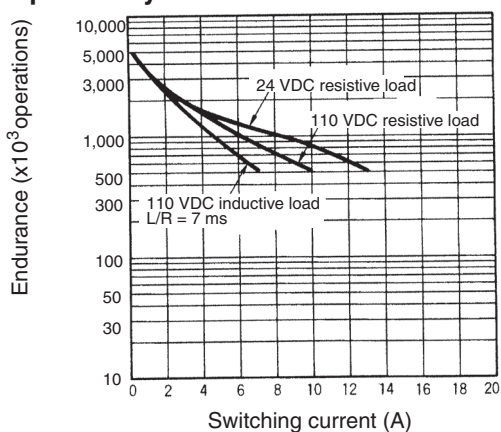

Cased Relays

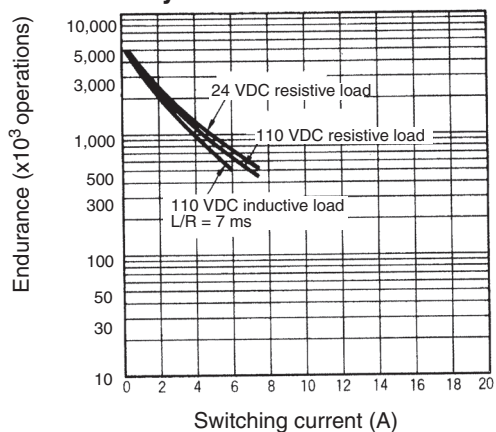

Relays Conforming to Auxiliary Power Relay Specifications

Maximum Switching Power

MM4P-JD

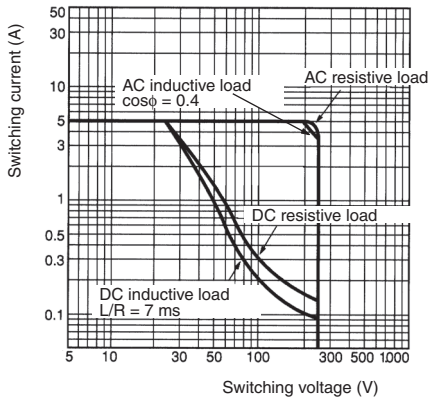

MM4XP-JD

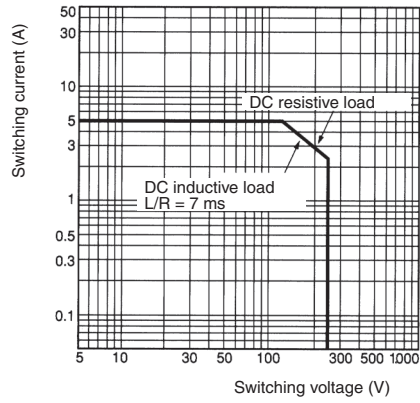

Endurance Curves

MM4P-JD

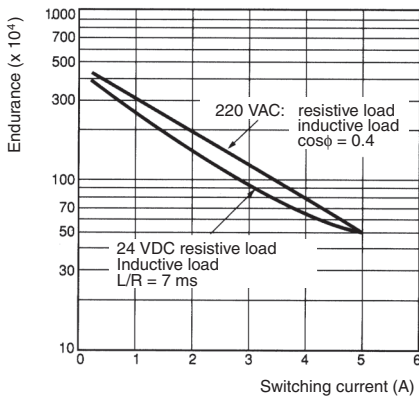

MM4XP-JD

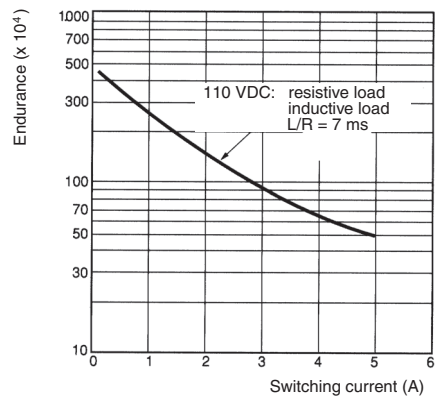

Ambient Temperature vs. Must-operate and Must-release Voltage

MM2P AC (60 Hz)

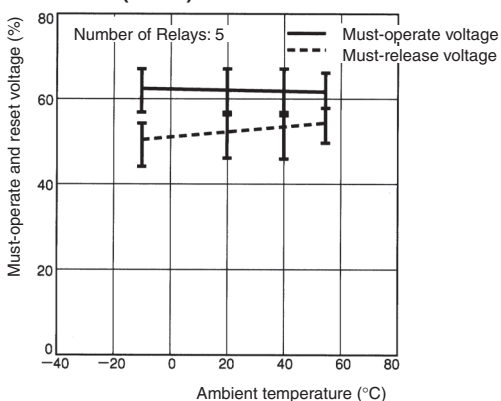

MM2P DC

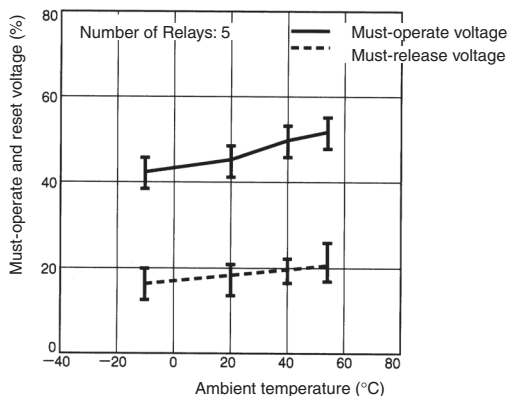

Ambient Temperature vs. Coil Temperature Rise

MM2P 110 VAC (60 Hz)

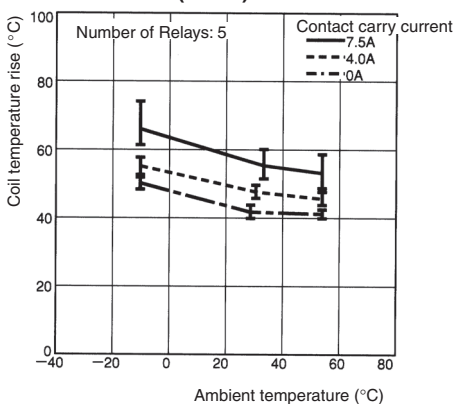

MM2P DC

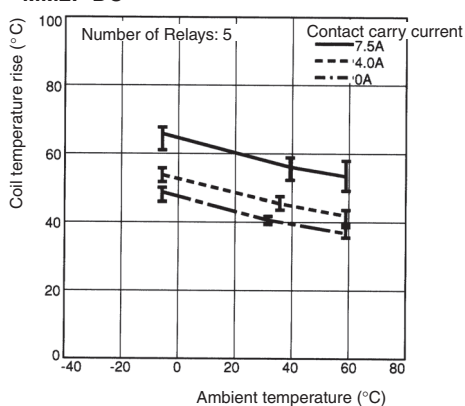

Malfunctioning Shock

MM2P AC

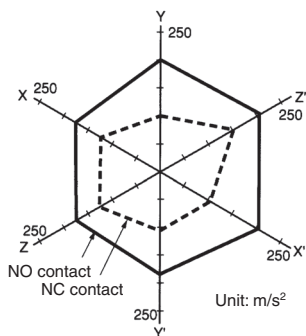

Number of samples: 5

Measurement conditions:
Impose a shock of 100 m/s² in the ±X, ±Y, and ±Z directions three times each with the Relay energized and not energized to check the shock values that cause the Relay to malfunction.

Shock direction

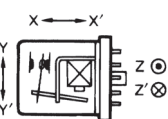

Contact Reliability

(Improved Allen-Bradley Test Circuit)

MM4P 24 VDC

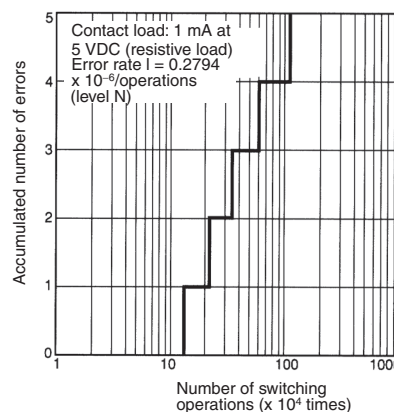
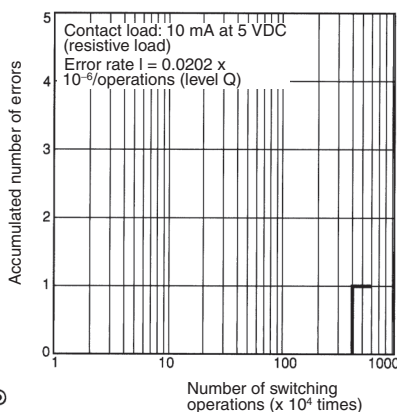

Relay Mounting Adjacent Distance vs. Coil Temperature Rise

MM4P 100/(110) VAC

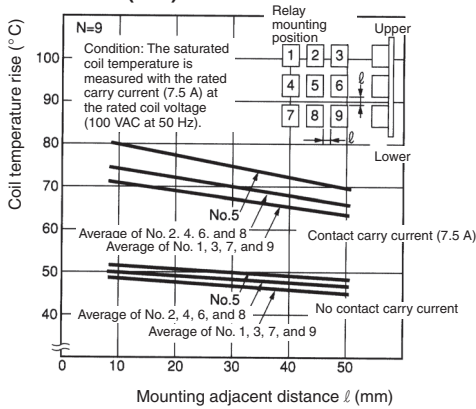

Dimensions

Note: All units are in millimeters unless otherwise indicated.

Standard Relays

Open Relays

Solder Terminals

MM2(X), MM4(X), MM3(X)

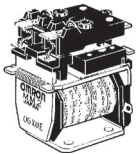

MM2

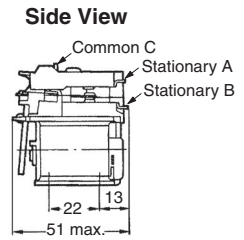
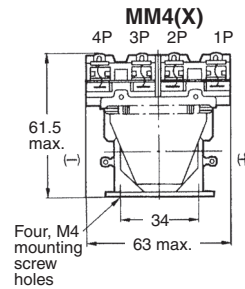
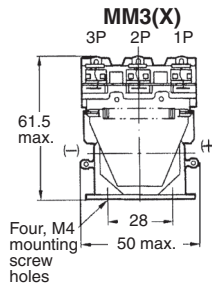
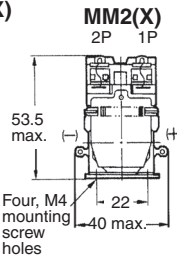

Note: Connect the common (C) of MM□X to positive (+).

Screw Terminals

MM2(X)B, MM3(X)B, MM4(X)B

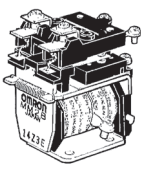

MM2B

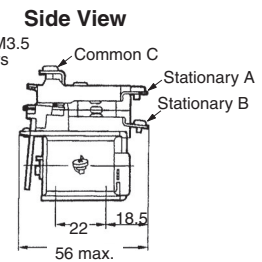
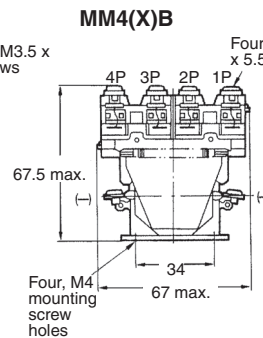
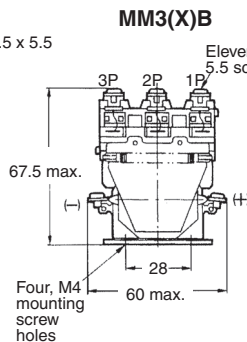
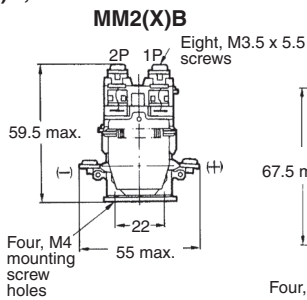

Note: Connect the common (C) of MM□XB to positive (+).

**Mounting Holes
(Bottom View)**

Direct mounting

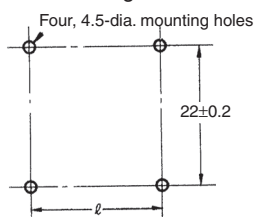

Length of l
 DPDT: 22 ± 0.2
 3PDT: 28 ± 0.2
 4PDT: 34 ± 0.2

**Mounting Bracket (S Bracket)
R99-03 (S KANAGU) FOR MM□**

The S Bracket can be used to mount a Relay with open solder or screw terminals.

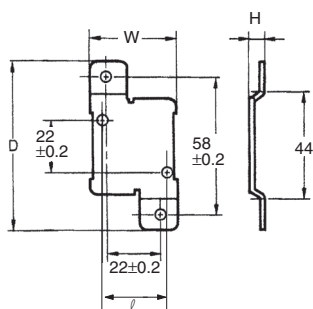
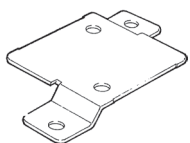

	R99-03 (S KANAGU) FOR MM2 (611) (DPDT)	R99-03 (S KANAGU) FOR MM3.4 (61) 3PDT, 4PDT
l	22	28, 34
D	71 max.	71 max.
W	36 max.	46 max.
H	6 max.	6 max.

Cased Relays

Plug-in Terminals

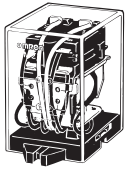

MM2P

MM2P(N, -D)
MM2XP(N, -D)

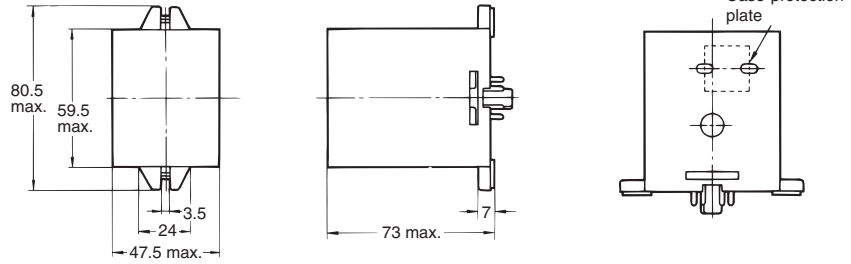

Note: As shown in the diagram, there are three 10-dia. holes in the side of the case for the MM2XP(N, -D).
When a case-protection plate is attached, the width of the Relay will be 48 mm max.

Terminal Arrangement (Bottom View)

Make sure that all common connections have the same polarity for the MM2XP-N/-D. The markings of the common connections on the casing all show "+" but the polarity of the common connections can be either negative or positive as long as they are all the same.

MM2P	MM2P-D	MM2PN	MM2PN	MM2PN
		6, 12, 24, 50 VAC 	6, 12, 24, 48 VDC 	100/(110), 200/(220) VAC 100/110, 200/220 VDC
MM2XP	MM2XP-D	MM2XPN	MM2XPN	MM2XPN
		6, 12, 24, 50 VAC 	6, 12, 24, 48 VDC 	100/(110), 200/(220) VAC 100/110, 200/220 VDC

Note: Wire the terminals correctly with no mistakes in coil polarity.

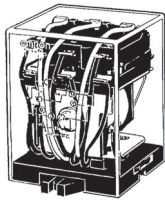

MM3P

MM3P(N)

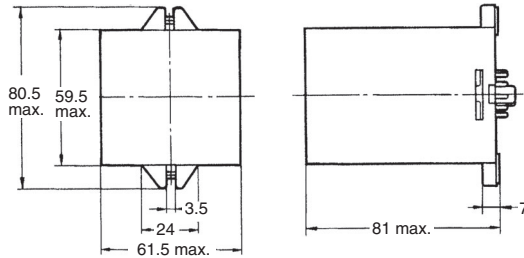

Terminal Arrangement (Bottom View)

MM3P	MM3PN	MM3PN	MM3PN
	6, 12, 24, 50 VAC 	6, 12, 24, 48 VDC 	100/(110), 200/(220) VAC 100/110, 200/220 VDC

Note: Wire the terminals correctly with no mistakes in coil polarity.

MM3XP(N)
MM4P(N, -D)
MM4XP(N, -D)

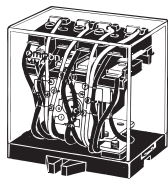

MM4P

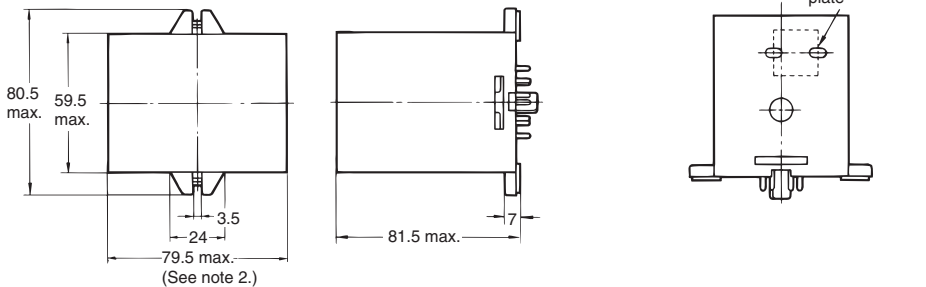

Note 1: As shown in the diagram, there are three 10-dia. holes in the side of the case for MM□XP(N, -D).
2: When a case-protection plate is attached, the width of the Relay will be 80 mm max.

Terminal Arrangement (Bottom View)

Make sure that all common connections have the same polarity for the MM□XP-N-D. The markings of the common connections on the casing all show "+" but the polarity of the common connections can be either negative or positive as long as they are all the same.

MM3XP	MM3XPN 6, 12, 24, 50 VAC	MM3XPN 6, 12, 24, 48 VDC	MM3XPN 100/(110), 200/(220) VAC 100/110, 200/220 VDC

MM4P	MM4P-D	MM4PN 6, 12, 24, 50 VAC	MM4PN 6, 12, 24, 48 VDC	MM4PN 100/(110), 200/(220) VAC 100/110, 200/220 VDC

MM4XP	MM4XP-D	MM4XPN 6, 12, 24, 50 VAC	MM4XPN 6, 12, 24, 48 VDC	MM4XPN 100/(110), 200/(220) VAC 100/110, 200/220 VDC

Note: Wire the terminals correctly with no mistakes in coil polarity.

MM4P-JD

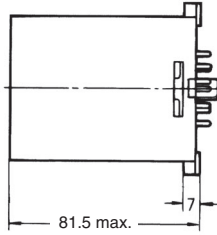
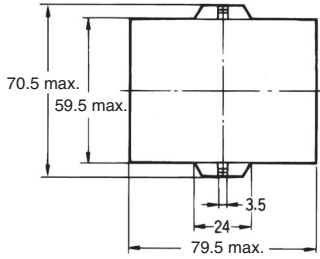
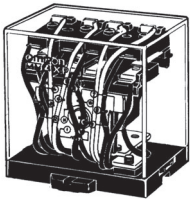

Terminal Arrangement (Bottom View)

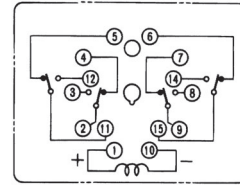

MM4XP-JD

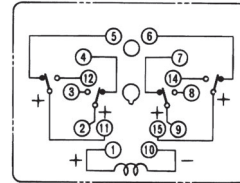
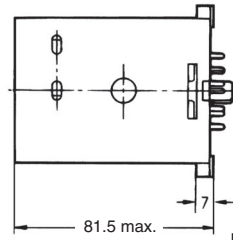
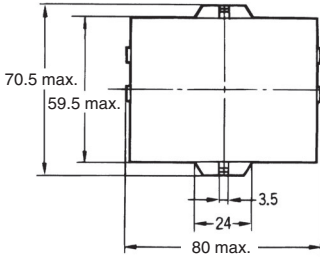
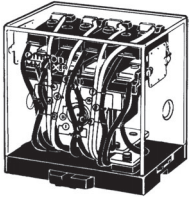

Note: Make sure that all common connections are the same in polarity. The markings of the common connections on the casing all show "+" but the polarity of the common connections can be either all negative or all positive.

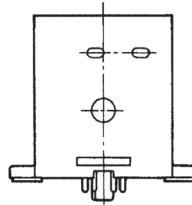

■ Relays with Operation Indicators

Dimensions are the same as those for standard Relays except that there are three 10-mm holes in the case as shown below.

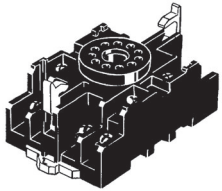

Accessories

■ Sockets

Relay model	DIN Track/Front-connecting Socket (screw terminals)	Back-connecting Socket (solder terminals)
MM2(X)P(-D)	8PFA	PL08
MM3P	11PFA 	PL11 
MM3XP, MM4(X)P(-D)	14PFA	PL15
MM4(X)P-JD	14PFA	---

Note: When using the MM4(X)P-JD (i.e., a model conforming to auxiliary power relay specifications) by itself, the PL15 Back-connecting Socket cannot be used.

Height with Socket

DIN Track/Front-connecting Socket

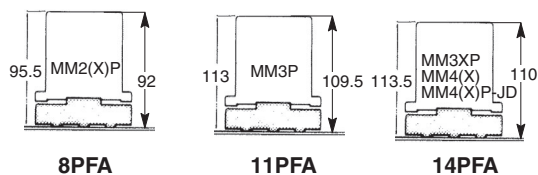

Back-connecting Socket

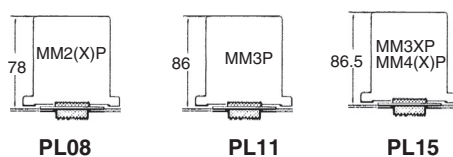

Safety Precautions

Refer to *Safety Precautions for All Relays*.

■ Connection

- Use proper crimp terminals or 1.2- to 2-mm-dia. single-conductor wire to connect screw terminals.
- Connect loads to DC-switching Relays so that arcs from adjacent terminals will not strike each other. E.g., connect all common terminals to the same polarity.
- Screw Terminal Model:
Do not bend the coil terminals, otherwise the coil wire may be disconnected. Make sure that the tightening torque applied to each terminal is 0.78 to 1.18 N·m and the insertion force is 49 N for 10 s.
- Do not reverse polarity when connecting open DC-switching Relays, including 3- and 4-pole models.

■ Installation

- Do not install the Relays where iron dust can adhere to the contacts or coil. Such dust can prevent the armature from moving freely and inhibit proper electrical contact.
- Relays can generate arcs externally. Either install the Relay in a location where a nearby object will not burn or use a covered Relay.
- DC-switching Relays contain a permanent magnet in the insulation base. Do not place a magnet or magnetic object near this base. Doing so will reduce the power of the permanent magnet, thus reducing Relay capacity.
- Insert PL Back-mounting Sockets from the back of the panel.
- Separate Relays from each other by at least 20 mm when mounting multiple Relays together.

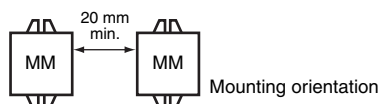

- Relays should be mounted with the armature facing down.

■ Wiring

When connecting a load to the contact terminals of a model for DC loads, consider the polarity of the contact terminals so that the generated arcs on the adjacent poles will not collide. If the common connections of the Relay are all positive or all negative, no arc collision will occur.

■ MMXP

The MMXP has a hole in the Relay case to allow gas to escape. Do not use this Relay in locations subject to excessive dust.

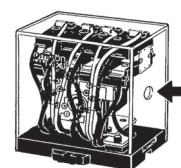

■ Contact Loads

The contact load should be greater than the power consumption of the coil. If it is less than this power consumption or if the Relay is operated very infrequently, the contact can change chemically thus causing unstable operation.

■ Soldering

When soldering solder terminals, do not let flux or other foreign matter adhere to contacts or do not let the coil terminals become bent. Also, solder as quickly as possible because excessive heat may damage the coil.

■ Diode Built into Relays

A diode is built into the Relays to absorb reverse electromotive force from the relay coil. The diode will be destroyed if a large external surge voltage is applied. If there is a possibility of a large external surge voltage being applied, take suitable measures to absorb the surge.

■ Storage

A model for DC loads incorporates a permanent magnetic for arc suppression. Keep floppy disks away from the Relay, otherwise the data on the floppy disk may be damaged.

■ Operating Environment

Do not use the Relay in places with flammable gas, otherwise an explosion may result due to an arc generated from the Relay

ALL DIMENSIONS SHOWN ARE IN MILLIMETERS.

To convert millimeters into inches, multiply by 0.03937. To convert grams into ounces, multiply by 0.03527.

In the interest of product improvement, specifications are subject to change without notice.

Read and Understand This Catalog

Please read and understand this catalog before purchasing the products. Please consult your OMRON representative if you have any questions or comments.

Warranty and Limitations of Liability

WARRANTY

OMRON's exclusive warranty is that the products are free from defects in materials and workmanship for a period of one year (or other period if specified) from date of sale by OMRON.

OMRON MAKES NO WARRANTY OR REPRESENTATION, EXPRESS OR IMPLIED, REGARDING NON-INFRINGEMENT, MERCHANTABILITY, OR FITNESS FOR PARTICULAR PURPOSE OF THE PRODUCTS. ANY BUYER OR USER ACKNOWLEDGES THAT THE BUYER OR USER ALONE HAS DETERMINED THAT THE PRODUCTS WILL SUITABLY MEET THE REQUIREMENTS OF THEIR INTENDED USE. OMRON DISCLAIMS ALL OTHER WARRANTIES, EXPRESS OR IMPLIED.

LIMITATIONS OF LIABILITY

OMRON SHALL NOT BE RESPONSIBLE FOR SPECIAL, INDIRECT, OR CONSEQUENTIAL DAMAGES, LOSS OF PROFITS OR COMMERCIAL LOSS IN ANY WAY CONNECTED WITH THE PRODUCTS, WHETHER SUCH CLAIM IS BASED ON CONTRACT, WARRANTY, NEGLIGENCE, OR STRICT LIABILITY.

In no event shall the responsibility of OMRON for any act exceed the individual price of the product on which liability is asserted.

IN NO EVENT SHALL OMRON BE RESPONSIBLE FOR WARRANTY, REPAIR, OR OTHER CLAIMS REGARDING THE PRODUCTS UNLESS OMRON'S ANALYSIS CONFIRMS THAT THE PRODUCTS WERE PROPERLY HANDLED, STORED, INSTALLED, AND MAINTAINED AND NOT SUBJECT TO CONTAMINATION, ABUSE, MISUSE, OR INAPPROPRIATE MODIFICATION OR REPAIR.

Application Considerations

SUITABILITY FOR USE

OMRON shall not be responsible for conformity with any standards, codes, or regulations that apply to the combination of products in the customer's application or use of the products.

At the customer's request, OMRON will provide applicable third party certification documents identifying ratings and limitations of use that apply to the products. This information by itself is not sufficient for a complete determination of the suitability of the products in combination with the end product, machine, system, or other application or use.

The following are some examples of applications for which particular attention must be given. This is not intended to be an exhaustive list of all possible uses of the products, nor is it intended to imply that the uses listed may be suitable for the products:

- Outdoor use, uses involving potential chemical contamination or electrical interference, or conditions or uses not described in this catalog.
- Nuclear energy control systems, combustion systems, railroad systems, aviation systems, medical equipment, amusement machines, vehicles, safety equipment, and installations subject to separate industry or government regulations.
- Systems, machines, and equipment that could present a risk to life or property.

Please know and observe all prohibitions of use applicable to the products.

NEVER USE THE PRODUCTS FOR AN APPLICATION INVOLVING SERIOUS RISK TO LIFE OR PROPERTY WITHOUT ENSURING THAT THE SYSTEM AS A WHOLE HAS BEEN DESIGNED TO ADDRESS THE RISKS, AND THAT THE OMRON PRODUCTS ARE PROPERLY RATED AND INSTALLED FOR THE INTENDED USE WITHIN THE OVERALL EQUIPMENT OR SYSTEM.

PROGRAMMABLE PRODUCTS

OMRON shall not be responsible for the user's programming of a programmable product, or any consequence thereof.

Disclaimers

CHANGE IN SPECIFICATIONS

Product specifications and accessories may be changed at any time based on improvements and other reasons.

It is our practice to change model numbers when published ratings or features are changed, or when significant construction changes are made. However, some specifications of the products may be changed without any notice. When in doubt, special model numbers may be assigned to fix or establish key specifications for your application on your request. Please consult with your OMRON representative at any time to confirm actual specifications of purchased products.

DIMENSIONS AND WEIGHTS

Dimensions and weights are nominal and are not to be used for manufacturing purposes, even when tolerances are shown.

PERFORMANCE DATA

Performance data given in this catalog is provided as a guide for the user in determining suitability and does not constitute a warranty. It may represent the result of OMRON's test conditions, and the users must correlate it to actual application requirements. Actual performance is subject to the OMRON Warranty and Limitations of Liability.

ERRORS AND OMISSIONS

The information in this document has been carefully checked and is believed to be accurate; however, no responsibility is assumed for clerical, typographical, or proofreading errors, or omissions.

2008.11

In the interest of product improvement, specifications are subject to change without notice.

OMRON Corporation
Industrial Automation Company

<http://www.ia.omron.com/>

(c)Copyright OMRON Corporation 2008 All Right Reserved.

Mouser Electronics

Authorized Distributor

Click to View Pricing, Inventory, Delivery & Lifecycle Information:

Omron:

[MM2KP-AC120](#) [MM2KP-AC24](#) [MM2P-AC200-220](#) [MM2P-D DC200/220](#) [MM2P-D DC24](#) [MM2P-DC24](#) [MM2XP-AC100](#) [MM2XP-D DC100/110](#) [MM2XP-D DC125](#) [MM2XP-D-DC24](#) [MM2XP-D-DC48](#) [MM3-AC100](#) [MM3BE-UA DC24](#) [MM3XP-AC200/220](#) [MM4KP DC24](#) [MM4KP-AC120](#) [MM4KP-AC200/220](#) [MM4P-AC220](#) [MM4XKP-DC125](#) [MM4XP-AC100/110](#) [MM4XP-AC120](#) [MM4XP-D DC200/220](#) [MM4XP-D DC24](#) [MM4XP-DC100/110](#) [MM4XP-DC125](#) [MM4XPN-AC200/\(220\)](#) [MM2 AC100/\(110\)](#) [MM2 AC200/\(220\)](#) [MM2B AC100/\(110\)](#) [MM2B DC24](#) [MM2 DC100/110](#) [MM2 DC12](#) [MM2 DC24](#) [MM2KP AC200](#) [MM2KP AC220](#) [MM2P AC120](#) [MM2PN DC24](#) [MM2XB DC24](#) [MM2X DC24](#) [MM2XKP DC125](#) [MM2XP AC110](#) [MM2XP AC125](#) [MM2XP AC200/\(220\)](#) [MM2XP DC125](#) [MM2XP DC24](#) [MM2XPN DC125](#) [MM3 DC24](#) [MM3P DC125](#) [MM3XKP DC125](#) [MM3XP DC125](#) [MM3XP DC200/220](#) [MM4 AC100](#) [MM4KP AC110](#) [MM4KP DC100/110](#) [MM4KP DC125](#) [MM4P AC110](#) [MM4P AC240](#) [MM4P DC100/110](#) [MM4XKP AC100/\(110\)](#) [MM4XKP AC125](#) [MM4XP DC24](#) [MM4XP DC48](#) [MM4XPN DC100/110](#)



Компания «ЭлектроПласт» предлагает заключение долгосрочных отношений при поставках импортных электронных компонентов на взаимовыгодных условиях!

Наши преимущества:

- Оперативные поставки широкого спектра электронных компонентов отечественного и импортного производства напрямую от производителей и с крупнейших мировых складов;
- Поставка более 17-ти миллионов наименований электронных компонентов;
- Поставка сложных, дефицитных, либо снятых с производства позиций;
- Оперативные сроки поставки под заказ (от 5 рабочих дней);
- Экспресс доставка в любую точку России;
- Техническая поддержка проекта, помощь в подборе аналогов, поставка прототипов;
- Система менеджмента качества сертифицирована по Международному стандарту ISO 9001;
- Лицензия ФСБ на осуществление работ с использованием сведений, составляющих государственную тайну;
- Поставка специализированных компонентов (Xilinx, Altera, Analog Devices, Intersil, Interpoint, Microsemi, Aeroflex, Peregrine, Syfer, Eurofarad, Texas Instrument, Miteq, Cobham, E2V, MA-COM, Hittite, Mini-Circuits, General Dynamics и др.);

Помимо этого, одним из направлений компании «ЭлектроПласт» является направление «Источники питания». Мы предлагаем Вам помощь Конструкторского отдела:

- Подбор оптимального решения, техническое обоснование при выборе компонента;
- Подбор аналогов;
- Консультации по применению компонента;
- Поставка образцов и прототипов;
- Техническая поддержка проекта;
- Защита от снятия компонента с производства.



Как с нами связаться

Телефон: 8 (812) 309 58 32 (многоканальный)

Факс: 8 (812) 320-02-42

Электронная почта: org@eplast1.ru

Адрес: 198099, г. Санкт-Петербург, ул. Калинина, дом 2, корпус 4, литера А.