

TimerBlox: Monostable Pulse Generator (One Shot)

FEATURES

- **Pulse Width Range: 1µs to 33.6 Seconds**
- Configured with 1 to 3 Resistors
- Pulse Width Max Error:
 - <2.3% for Pulse Width > 512µs
 - <3.4% for Pulse Width of 8µs to 512µs
 - <4.9% for Pulse Width of 1µs to 8µs
- Four LTC6993 Options Available:
 - Rising-Edge or Falling-Edge Trigger
 - Retriggerable or Non-Retriggerable
- Configurable for Positive or Negative Output Pulse
- Fast Recovery Time
- 2.25V to 5.5V Single Supply Operation
- 70µA Supply Current at 10µs Pulse Width
- 500µs Start-Up Time
- CMOS Output Driver Sources/Sinks 20mA
- -55°C to 125°C Operating Temperature Range
- Available in Low Profile (1mm) SOT-23 (ThinSOT™) and 2mm × 3mm DFN

APPLICATIONS

- Watchdog Timer
- Frequency Discriminators
- Missing Pulse Detection
- Envelope Detection
- High Vibration, High Acceleration Environments
- Portable and Battery-Powered Equipment

LT, LT, LTC, LTM, Linear Technology, TimerBlox and the Linear logo are registered trademarks and ThinSOT is a trademark of Linear Technology Corporation. All other trademarks are the property of their respective owners.

DESCRIPTION

The LTC6993 is a monostable multivibrator (also known as a “one-shot” pulse generator) with a programmable pulse width of 1µs to 33.6 seconds. The LTC6993 is part of the TimerBlox® family of versatile silicon timing devices.

A single resistor, R_{SET} , programs an internal master oscillator frequency, setting the LTC6993’s time base. The output pulse width is determined by this master oscillator and an internal clock divider, N_{DIV} , programmable to eight settings from 1 to 2^{21} .

$$t_{OUT} = \frac{N_{DIV} \cdot R_{SET}}{50k\Omega} \cdot 1\mu s, N_{DIV} = 1, 8, 64, \dots, 2^{21}$$

The output pulse is initiated by a transition on the trigger input (TRIG). Each part can be configured to generate positive or negative output pulses. The LTC6993 is available in four versions to provide different trigger signal polarity and retrigger capability.

DEVICE	INPUT POLARITY	RETRIGGER
LTC6993-1	Rising-Edge	No
LTC6993-2	Rising-Edge	Yes
LTC6993-3	Falling-Edge	No
LTC6993-4	Falling-Edge	Yes

The LTC6993 also offers the ability to dynamically adjust the width of the output pulse via a separate control voltage.

For easy configuration of the LTC6993, download the TimerBlox Designer tool at www.linear.com/timerblox.

TYPICAL APPLICATION

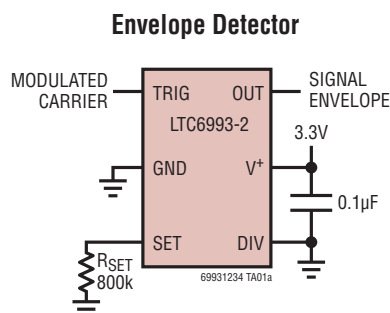

69931234fc

LTC6993-1/LTC6993-2 LTC6993-3/LTC6993-4

ABSOLUTE MAXIMUM RATINGS (Note 1)

Supply Voltage (V^+) to GND	6V	Specified Temperature Range (Note 3)	
Maximum Voltage on Any Pin		LTC6993C	0°C to 70°C
..... ($GND - 0.3V \leq V_{PIN} \leq (V^+ + 0.3V)$)		LTC6993I	-40°C to 85°C
Operating Temperature Range (Note 2)		LTC6993H	-40°C to 125°C
LTC6993C	-40°C to 85°C	LTC6993MP	-55°C to 125°C
LTC6993I	-40°C to 85°C	Junction Temperature	150°C
LTC6993H	-40°C to 125°C	Storage Temperature Range	-65°C to 150°C
LTC6993MP	-55°C to 125°C	Lead Temperature (Soldering, 10 sec)	
		S6 Package	300°C

PIN CONFIGURATION



ORDER INFORMATION

Lead Free Finish

TAPE AND REEL (MINI)	TAPE AND REEL	PART MARKING*	PACKAGE DESCRIPTION	SPECIFIED TEMPERATURE RANGE
LTC6993CDCB-1#TRMPBF	LTC6993CDCB-1#TRPBF	LDXH	6-Lead (2mm × 3mm) Plastic DFN	0°C to 70°C
LTC6993IDCB-1#TRMPBF	LTC6993IDCB-1#TRPBF	LDXH	6-Lead (2mm × 3mm) Plastic DFN	-40°C to 85°C
LTC6993HDCB-1#TRMPBF	LTC6993HDCB-1#TRPBF	LDXH	6-Lead (2mm × 3mm) Plastic DFN	-40°C to 125°C
LTC6993CDCB-2#TRMPBF	LTC6993CDCB-2#TRPBF	LDXK	6-Lead (2mm × 3mm) Plastic DFN	0°C to 70°C
LTC6993IDCB-2#TRMPBF	LTC6993IDCB-2#TRPBF	LDXK	6-Lead (2mm × 3mm) Plastic DFN	-40°C to 85°C
LTC6993HDCB-2#TRMPBF	LTC6993HDCB-2#TRPBF	LDXK	6-Lead (2mm × 3mm) Plastic DFN	-40°C to 125°C
LTC6993CDCB-3#TRMPBF	LTC6993CDCB-3#TRPBF	LFMJ	6-Lead (2mm × 3mm) Plastic DFN	0°C to 70°C
LTC6993IDCB-3#TRMPBF	LTC6993IDCB-3#TRPBF	LFMJ	6-Lead (2mm × 3mm) Plastic DFN	-40°C to 85°C
LTC6993HDCB-3#TRMPBF	LTC6993HDCB-3#TRPBF	LFMJ	6-Lead (2mm × 3mm) Plastic DFN	-40°C to 125°C
LTC6993CDCB-4#TRMPBF	LTC6993CDCB-4#TRPBF	LFMM	6-Lead (2mm × 3mm) Plastic DFN	0°C to 70°C
LTC6993IDCB-4#TRMPBF	LTC6993IDCB-4#TRPBF	LFMM	6-Lead (2mm × 3mm) Plastic DFN	-40°C to 85°C
LTC6993HDCB-4#TRMPBF	LTC6993HDCB-4#TRPBF	LFMM	6-Lead (2mm × 3mm) Plastic DFN	-40°C to 125°C
LTC6993CS6-1#TRMPBF	LTC6993CS6-1#TRPBF	LTDXG	6-Lead Plastic TSOT-23	0°C to 70°C
LTC6993IS6-1#TRMPBF	LTC6993IS6-1#TRPBF	LTDXG	6-Lead Plastic TSOT-23	-40°C to 85°C
LTC6993HS6-1#TRMPBF	LTC6993HS6-1#TRPBF	LTDXG	6-Lead Plastic TSOT-23	-40°C to 125°C

69931234fc

ORDER INFORMATION

Lead Free Finish

TAPE AND REEL (MINI)	TAPE AND REEL	PART MARKING*	PACKAGE DESCRIPTION	SPECIFIED TEMPERATURE RANGE
LTC6993CS6-2#TRMPBF	LTC6993CS6-2#TRPBF	LTDXJ	6-Lead Plastic TSOT-23	0°C to 70°C
LTC6993IS6-2#TRMPBF	LTC6993IS6-2#TRPBF	LTDXJ	6-Lead Plastic TSOT-23	-40°C to 85°C
LTC6993HS6-2#TRMPBF	LTC6993HS6-2#TRPBF	LTDXJ	6-Lead Plastic TSOT-23	-40°C to 125°C
LTC6993CS6-3#TRMPBF	LTC6993CS6-3#TRPBF	LTFMH	6-Lead Plastic TSOT-23	0°C to 70°C
LTC6993IS6-3#TRMPBF	LTC6993IS6-3#TRPBF	LTFMH	6-Lead Plastic TSOT-23	-40°C to 85°C
LTC6993HS6-3#TRMPBF	LTC6993HS6-3#TRPBF	LTFMH	6-Lead Plastic TSOT-23	-40°C to 125°C
LTC6993CS6-4#TRMPBF	LTC6993CS6-4#TRPBF	LTFMK	6-Lead Plastic TSOT-23	0°C to 70°C
LTC6993IS6-4#TRMPBF	LTC6993IS6-4#TRPBF	LTFMK	6-Lead Plastic TSOT-23	-40°C to 85°C
LTC6993HS6-4#TRMPBF	LTC6993HS6-4#TRPBF	LTFMK	6-Lead Plastic TSOT-23	-40°C to 125°C
LTC6993MPS6-1#TRMPBF	LTC6993MPS6-1#TRPBF	LTDXG	6-Lead Plastic TSOT-23	-55°C to 125°C
LTC6993MPS6-2#TRMPBF	LTC6993MPS6-2#TRPBF	LTDXJ	6-Lead Plastic TSOT-23	-55°C to 125°C
LTC6993MPS6-3#TRMPBF	LTC6993MPS6-3#TRPBF	LTFMH	6-Lead Plastic TSOT-23	-55°C to 125°C
LTC6993MPS6-4#TRMPBF	LTC6993MPS6-4#TRPBF	LTFMK	6-Lead Plastic TSOT-23	-55°C to 125°C

TRM = 500 pieces. *Temperature grades are identified by a label on the shipping container.

Consult LTC Marketing for parts specified with wider operating temperature ranges.

For more information on lead free part marking, go to: <http://www.linear.com/leadfree/>

For more information on tape and reel specifications, go to: <http://www.linear.com/tapeandreel/>. Some packages are available in 500 unit reels through designated sales channels with #TRMPBF suffix.

ELECTRICAL CHARACTERISTICS

The ● denotes the specifications which apply over the full operating temperature range, otherwise specifications are at $T_A = 25^\circ\text{C}$. Test conditions are $V^+ = 2.25\text{V}$ to 5.5V , $\text{TRIG} = 0\text{V}$, $\text{DIVCODE} = 0$ to 15 ($N_{\text{DIV}} = 1$ to 2^{21}), $R_{\text{SET}} = 50\text{k}$ to 800k , $R_{\text{LOAD}} = 5\text{k}$, $C_{\text{LOAD}} = 5\text{pF}$ unless otherwise noted.

SYMBOL	PARAMETER	CONDITIONS	MIN	TYP	MAX	UNITS	
t_{OUT}	Output Pulse Width		1 μ		33.55	sec	
Δt_{OUT}	Pulse Width Accuracy (Note 4)	$N_{\text{DIV}} \geq 512$		±1.7	±2.3 ±3.0	% %	
		$8 \leq N_{\text{DIV}} \leq 64$		±2.4	±3.4 ±4.4	% %	
		$N_{\text{DIV}} = 1$ (LTC6993-1 or LTC6993-2)		±3.6	±4.9 ±6.0	% %	
		$N_{\text{DIV}} = 1$ (LTC6993-3 or LTC6993-4)		±4.0	±5.3 ±6.4	% %	
$\Delta t_{\text{OUT}}/\Delta T$	Pulse Width Drift Over Temperature	$N_{\text{DIV}} \geq 512$		±0.006		%/°C	
		$N_{\text{DIV}} \leq 64$		±0.008		%/°C	
	Pulse Width Change With Supply	$N_{\text{DIV}} \geq 512$	$V^+ = 4.5\text{V}$ to 5.5V	●	-0.6	-0.2	%
			$V^+ = 2.25\text{V}$ to 4.5V	●	-0.4	-0.1	%
		$8 \leq N_{\text{DIV}} \leq 64$	$V^+ = 4.5\text{V}$ to 5.5V	●	-0.9	-0.2	%
			$V^+ = 2.7\text{V}$ to 4.5V	●	-0.7	-0.2	0.4
		$V^+ = 2.25\text{V}$ to 2.7V	●	-1.1	-0.1	0.9	%

LTC6993-1/LTC6993-2

LTC6993-3/LTC6993-4

ELECTRICAL CHARACTERISTICS The ● denotes the specifications which apply over the full operating temperature range, otherwise specifications are at $T_A = 25^\circ\text{C}$. Test conditions are $V^+ = 2.25\text{V}$ to 5.5V , $\text{TRIG} = 0\text{V}$, $\text{DIVCODE} = 0$ to 15 ($N_{\text{DIV}} = 1$ to 2^{21}), $R_{\text{SET}} = 50\text{k}$ to 800k , $R_{\text{LOAD}} = 5\text{k}$, $C_{\text{LOAD}} = 5\text{pF}$ unless otherwise noted.

SYMBOL	PARAMETER	CONDITIONS	MIN	TYP	MAX	UNITS	
	Pulse Width Jitter (Note 10)	$N_{\text{DIV}} = 1$	$V^+ = 5.5\text{V}$	0.85		%p-p	
			$V^+ = 2.25\text{V}$	0.45		%p-p	
		$N_{\text{DIV}} = 8$		0.20		%p-p	
		$N_{\text{DIV}} = 64$		0.05		%p-p	
		$N_{\text{DIV}} = 512$		0.20		%p-p	
	$N_{\text{DIV}} = 4096$		0.03		%p-p		
t_S	Pulse Width Change Settling Time (Note 9)	$t_{\text{MASTER}} = t_{\text{OUT}}/N_{\text{DIV}}$		$6 \cdot t_{\text{MASTER}}$		μs	
Power Supply							
V^+	Operating Supply Voltage Range		●	2.25	5.5	V	
	Power-On Reset Voltage		●		1.95	V	
$I_S(\text{IDLE})$	Supply Current (Idle)	$R_L = \infty$, $R_{\text{SET}} = 50\text{k}$, $N_{\text{DIV}} \leq 64$	$V^+ = 5.5\text{V}$	●	165	200	μA
			$V^+ = 2.25\text{V}$	●	125	160	μA
		$R_L = \infty$, $R_{\text{SET}} = 50\text{k}$, $N_{\text{DIV}} \geq 512$	$V^+ = 5.5\text{V}$	●	135	175	μA
			$V^+ = 2.25\text{V}$	●	105	140	μA
	$R_L = \infty$, $R_{\text{SET}} = 800\text{k}$, $N_{\text{DIV}} \leq 64$	$V^+ = 5.5\text{V}$	●	70	110	μA	
		$V^+ = 2.25\text{V}$	●	60	95	μA	
	$R_L = \infty$, $R_{\text{SET}} = 800\text{k}$, $N_{\text{DIV}} \geq 512$	$V^+ = 5.5\text{V}$	●	65	100	μA	
		$V^+ = 2.25\text{V}$	●	55	90	μA	
Analog Inputs							
V_{SET}	Voltage at SET Pin		●	0.97	1.00	1.03	V
$\Delta V_{\text{SET}}/\Delta T$	V_{SET} Drift Over Temperature		●		± 75		$\mu\text{V}/^\circ\text{C}$
R_{SET}	Frequency-Setting Resistor		●	50	800		$\text{k}\Omega$
V_{DIV}	DIV Pin Voltage		●	0	V^+		V
$\Delta V_{\text{DIV}}/\Delta V^+$	DIV Pin Valid Code Range (Note 5)	Deviation from Ideal $V_{\text{DIV}}/V^+ = (\text{DIVCODE} + 0.5)/16$	●		± 1.5		%
	DIV Pin Input Current		●		± 10		nA
Digital I/O							
	TRIG Pin Input Capacitance			2.5			pF
	TRIG Pin Input Current	$\text{TRIG} = 0\text{V}$ to V^+			± 10		nA
V_{IH}	High Level TRIG Pin Input Voltage	(Note 6)	●	$0.7 \cdot V^+$			V
V_{IL}	Low Level TRIG Pin Input Voltage	(Note 6)	●		$0.3 \cdot V^+$		V
$I_{\text{OUT(MAX)}}$	Output Current	$V^+ = 2.7\text{V}$ to 5.5V			± 20		mA
V_{OH}	High Level Output Voltage (Note 7)	$V^+ = 5.5\text{V}$	$I_{\text{OUT}} = -1\text{mA}$	●	5.45	5.48	V
			$I_{\text{OUT}} = -16\text{mA}$	●	4.84	5.15	V
		$V^+ = 3.3\text{V}$	$I_{\text{OUT}} = -1\text{mA}$	●	3.24	3.27	V
			$I_{\text{OUT}} = -10\text{mA}$	●	2.75	2.99	V
		$V^+ = 2.25\text{V}$	$I_{\text{OUT}} = -1\text{mA}$	●	2.17	2.21	V
			$I_{\text{OUT}} = -8\text{mA}$	●	1.58	1.88	V
V_{OL}	Low Level Output Voltage (Note 7)	$V^+ = 5.5\text{V}$	$I_{\text{OUT}} = 1\text{mA}$	●	0.02	0.04	V
			$I_{\text{OUT}} = 16\text{mA}$	●	0.26	0.54	V
		$V^+ = 3.3\text{V}$	$I_{\text{OUT}} = 1\text{mA}$	●	0.03	0.05	V
			$I_{\text{OUT}} = 10\text{mA}$	●	0.22	0.46	V
		$V^+ = 2.25\text{V}$	$I_{\text{OUT}} = 1\text{mA}$	●	0.03	0.07	V
			$I_{\text{OUT}} = 8\text{mA}$	●	0.26	0.54	V

69931234fc

ELECTRICAL CHARACTERISTICS The ● denotes the specifications which apply over the full operating temperature range, otherwise specifications are at $T_A = 25^\circ\text{C}$. Test conditions are $V^+ = 2.25\text{V}$ to 5.5V , $\text{TRIG} = 0\text{V}$, $\text{DIVCODE} = 0$ to 15 ($N_{\text{DIV}} = 1$ to 2^{21}), $R_{\text{SET}} = 50\text{k}$ to 800k , $R_{\text{LOAD}} = \infty$, $C_{\text{LOAD}} = 5\text{pF}$ unless otherwise noted.

SYMBOL	PARAMETER	CONDITIONS	MIN	TYP	MAX	UNITS
t_{PD}	Trigger Propagation Delay	$V^+ = 5.5\text{V}$ $V^+ = 3.3\text{V}$ $V^+ = 2.25\text{V}$		11 17 28		ns ns ns
t_{WIDTH}	Minimum Recognized TRIG Pulse Width	$V^+ = 3.3\text{V}$		5		ns
t_{ARM}	Recovery Time (LTC6993-1/LTC6993-3)			-4		ns
t_{RETRIG}	Time Between Trigger Signals (LTC6993-2/LTC6993-4)	$N_{\text{DIV}} = 1$ $V^+ = 3.3\text{V}$ $N_{\text{DIV}} > 1$ $V^+ = 3.3\text{V}$		10 50		ns ns
t_r	Output Rise Time (Note 8)	$V^+ = 5.5\text{V}$ $V^+ = 3.3\text{V}$ $V^+ = 2.25\text{V}$		1.1 1.7 2.7		ns ns ns
t_f	Output Fall Time (Note 8)	$V^+ = 5.5\text{V}$ $V^+ = 3.3\text{V}$ $V^+ = 2.25\text{V}$		1.0 1.6 2.4		ns ns ns

Note 1: Stresses beyond those listed under Absolute Maximum Ratings may cause permanent damage to the device. Exposure to any Absolute Maximum Rating condition for extended periods may affect device reliability and lifetime.

Note 2: The LTC6993C is guaranteed functional over the operating temperature range of -40°C to 85°C .

Note 3: The LTC6993C is guaranteed to meet specified performance from 0°C to 70°C . The LTC6993C is designed, characterized and expected to meet specified performance from -40°C to 85°C but it is not tested or QA sampled at these temperatures. The LTC6993I is guaranteed to meet specified performance from -40°C to 85°C . The LTC6993H is guaranteed to meet specified performance from -40°C to 125°C . The LTC6993MP is guaranteed to meet specified performance from -55°C to 125°C .

Note 4: Pulse width accuracy is defined as the deviation from the t_{OUT} equation, assuming R_{SET} is used to program the pulse width.

Note 5: See Operation section, Table 1 and Figure 2 for a full explanation of how the DIV pin voltage selects the value of DIVCODE.

Note 6: The TRIG pin has hysteresis to accommodate slow rising or falling signals. The threshold voltages are proportional to V^+ . Typical values can be estimated at any supply voltage using:

$$V_{\text{TRIG(RISING)}} \approx 0.55 \cdot V^+ + 185\text{mV}$$

$$V_{\text{TRIG(FALLING)}} \approx 0.48 \cdot V^+ - 155\text{mV}$$

Note 7: To conform to the Logic IC Standard, current out of a pin is arbitrarily given a negative value.

Note 8: Output rise and fall times are measured between the 10% and the 90% power supply levels with 5pF output load. These specifications are based on characterization.

Note 9: Settling time is the amount of time required for the output to settle within $\pm 1\%$ of the final pulse width after a $0.5\times$ or $2\times$ change in I_{SET} .

Note 10: Jitter is the ratio of the deviation of the output pulse width to the mean of the pulse width. This specification is based on characterization and is not 100% tested.

TYPICAL PERFORMANCE CHARACTERISTICS

$V^+ = 3.3V$, $R_{SET} = 200k$ and $T_A = 25^\circ C$ unless otherwise noted.

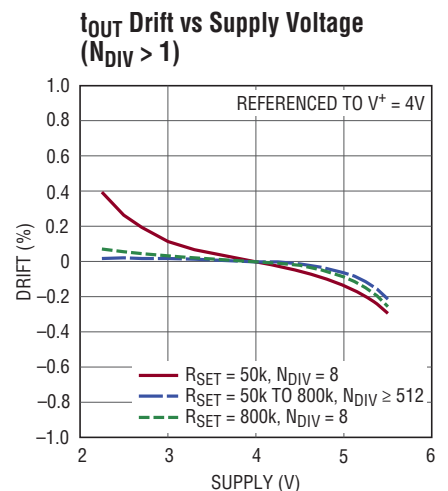

TYPICAL PERFORMANCE CHARACTERISTICS

$V^+ = 3.3V$, $R_{SET} = 200k$ and $T_A = 25^\circ C$ unless otherwise noted.

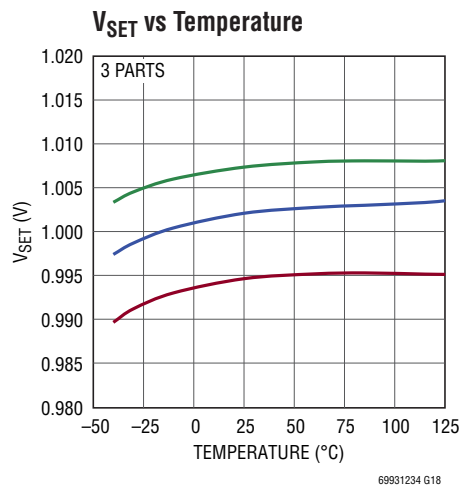
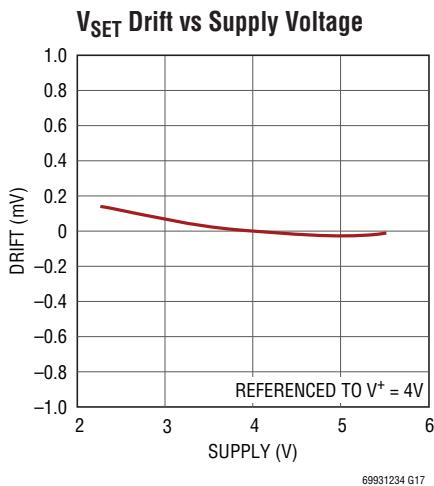
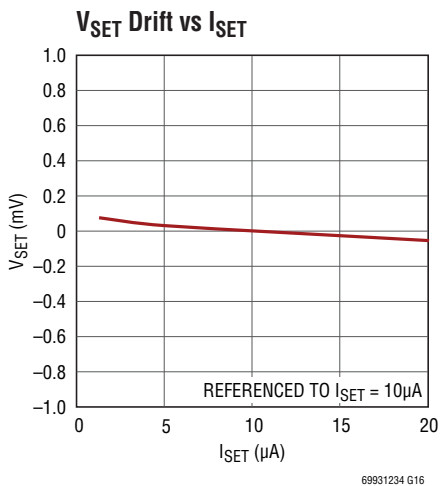
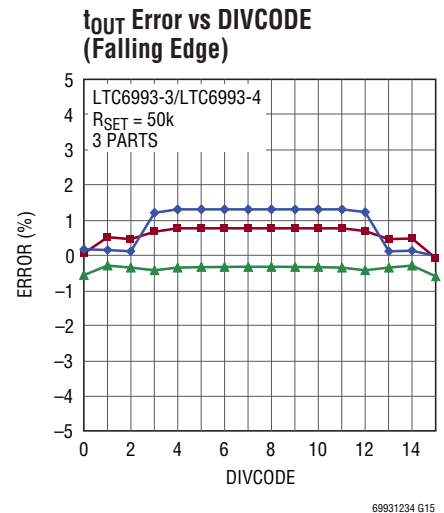
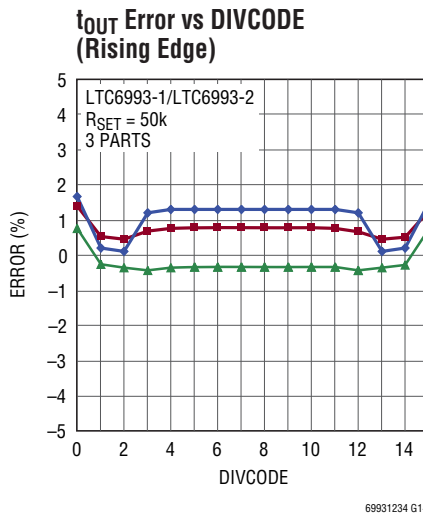
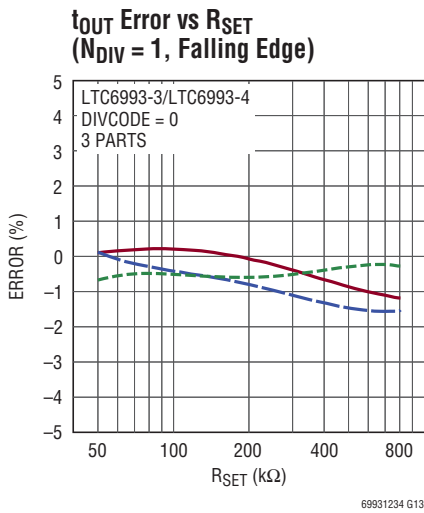
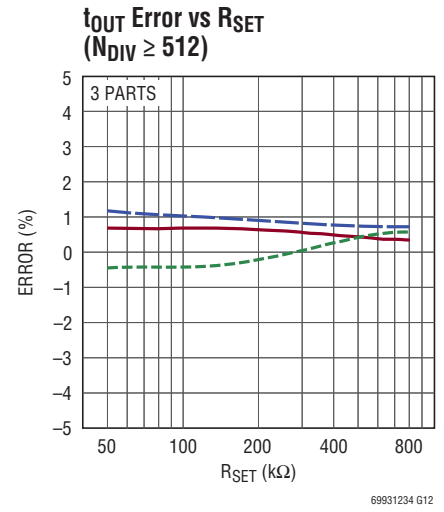
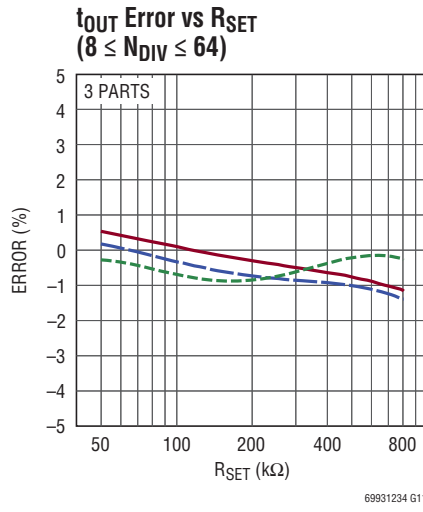
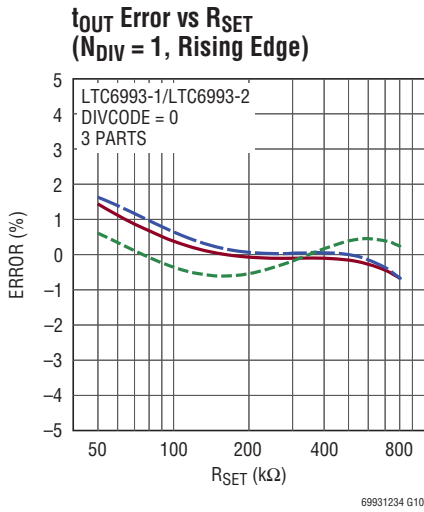

TYPICAL PERFORMANCE CHARACTERISTICS

$V^+ = 3.3V$, $R_{SET} = 200k$ and $T_A = 25^\circ C$ unless otherwise noted.

Typical V_{SET} Distribution

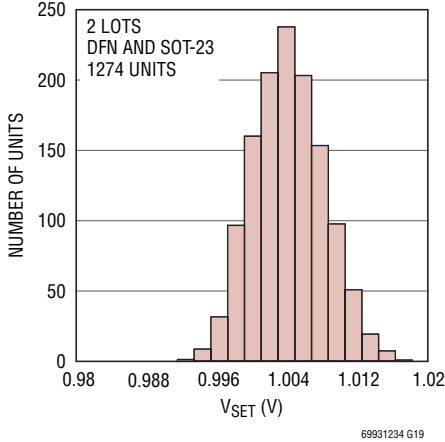

Supply Current vs Supply Voltage

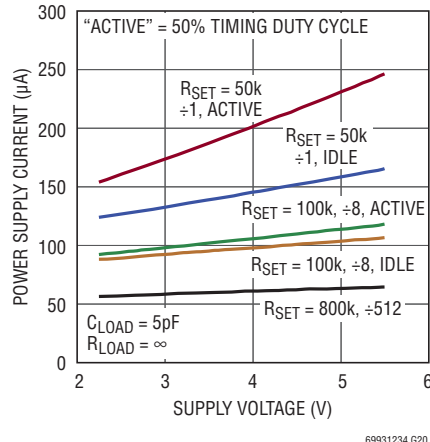

Supply Current vs Temperature

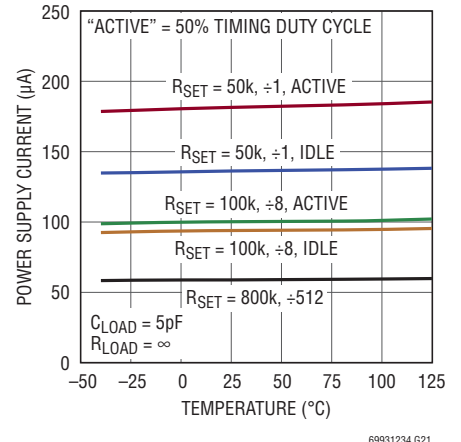

Supply Current vs TRIG Pin Voltage

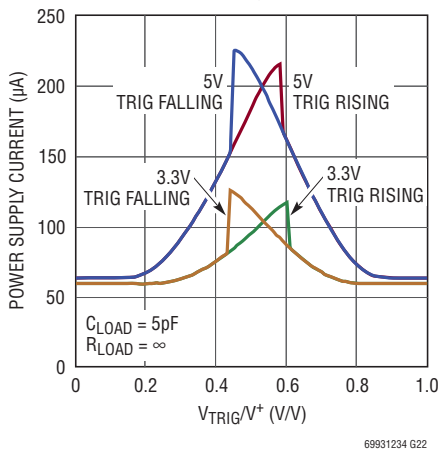

Supply Current vs t_{OUT} (5V)

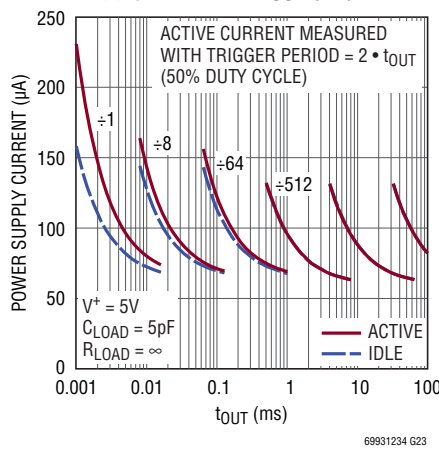

Supply Current vs t_{OUT} (2.5V)

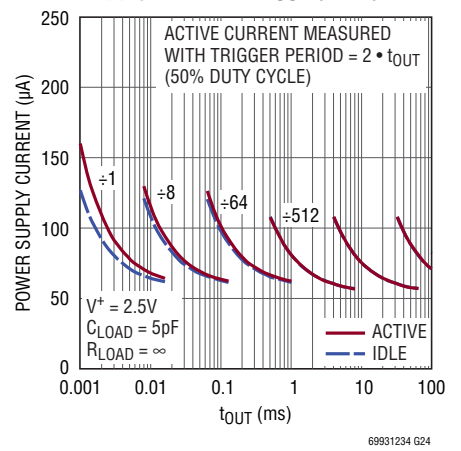

TRIG Threshold Voltage vs Supply Voltage

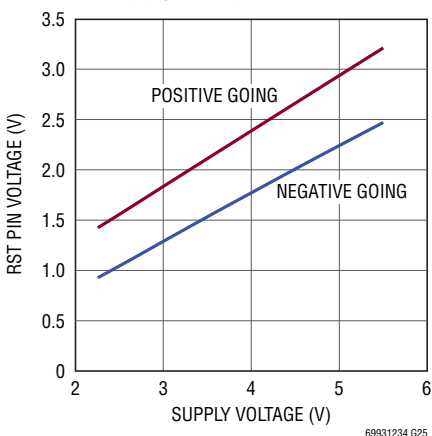

Peak-to-Peak Jitter vs t_{OUT}

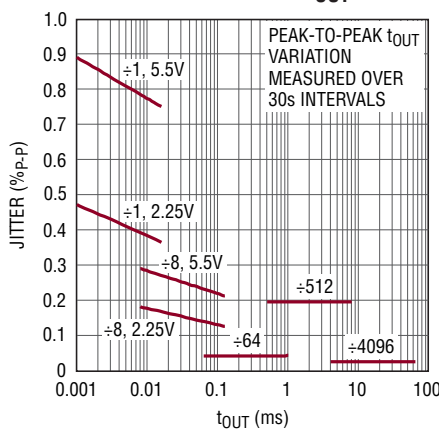

Typical I_{SET} Current Limit vs V^+

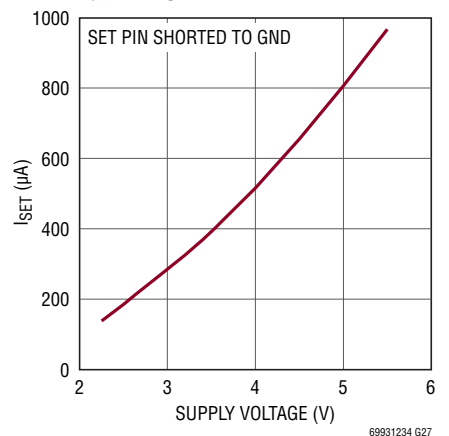

TYPICAL PERFORMANCE CHARACTERISTICS

$V^+ = 3.3V$, $R_{SET} = 200k$ and $T_A = 25^\circ C$ unless otherwise noted.

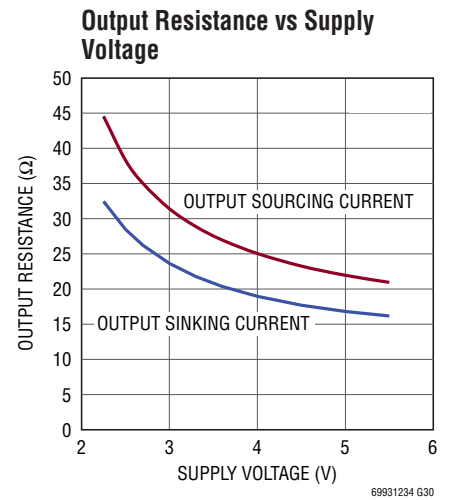
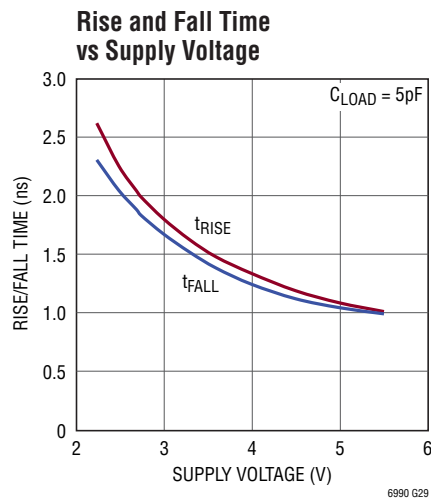
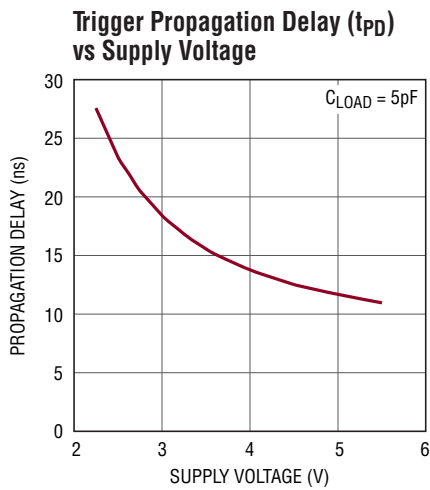

PIN FUNCTIONS (DCB/S6)

V⁺ (Pin 1/Pin 5): Supply Voltage (2.25V to 5.5V). This supply should be kept free from noise and ripple. It should be bypassed directly to the GND pin with a 0.1 μ F capacitor.

DIV (Pin 2/Pin 4): Programmable Divider and Polarity Input. The DIV pin voltage (V_{DIV}) is internally converted into a 4-bit result (DIVCODE). V_{DIV} may be generated by a resistor divider between V⁺ and GND. Use 1% resistors to ensure an accurate result. The DIV pin and resistors should be shielded from the OUT pin or any other traces that have fast edges. Limit the capacitance on the DIV pin to less than 100pF so that V_{DIV} settles quickly. The MSB of DIVCODE (POL) determines the polarity of the OUT pins. When POL = 0 the output produces a positive pulse. When POL = 1 the output produces a negative pulse.

SET (Pin 3/Pin 3): Pulse Width Setting Input. The voltage on the SET pin (V_{SET}) is regulated to 1V above GND. The amount of current sourced from the SET pin (I_{SET}) programs the master oscillator frequency. The I_{SET} current range is 1.25 μ A to 20 μ A. The output pulse will continue indefinitely if I_{SET} drops below approximately 500nA, and will terminate when I_{SET} increases again. A resistor connected between SET and GND is the most accurate way to set the pulse width. For best performance, use a precision metal or thin film resistor of 0.5% or better

tolerance and 50ppm/ $^{\circ}$ C or better temperature coefficient. For lower accuracy applications an inexpensive 1% thick film resistor may be used.

Limit the capacitance on the SET pin to less than 10pF to minimize jitter and ensure stability. Capacitance less than 100pF maintains the stability of the feedback circuit regulating the V_{SET} voltage.

TRIG (Pin 4/Pin 1): Trigger Input. Depending on the version, a rising or falling edge on TRIG will initiate the output pulse. LTC6993-1 and LTC6993-2 are rising-edge sensitive. LTC6993-3 and LTC6993-4 are falling-edge sensitive.

The LTC6993-2 and LTC6993-4 are retriggerable, allowing the pulse width to be extended by additional trigger signals that occur while the output is active. The LTC6993-1/LTC6993-3 will ignore additional trigger inputs until the output pulse has terminated.

GND (Pin 5/Pin 2): Ground. Tie to a low inductance ground plane for best performance.

OUT (Pin 6/Pin 6): Output. The OUT pin swings from GND to V⁺ with an output resistance of approximately 30 Ω . When driving an LED or other low impedance load a series output resistor should be used to limit source/sink current to 20mA.



BLOCK DIAGRAM (S6 package pin numbers shown)

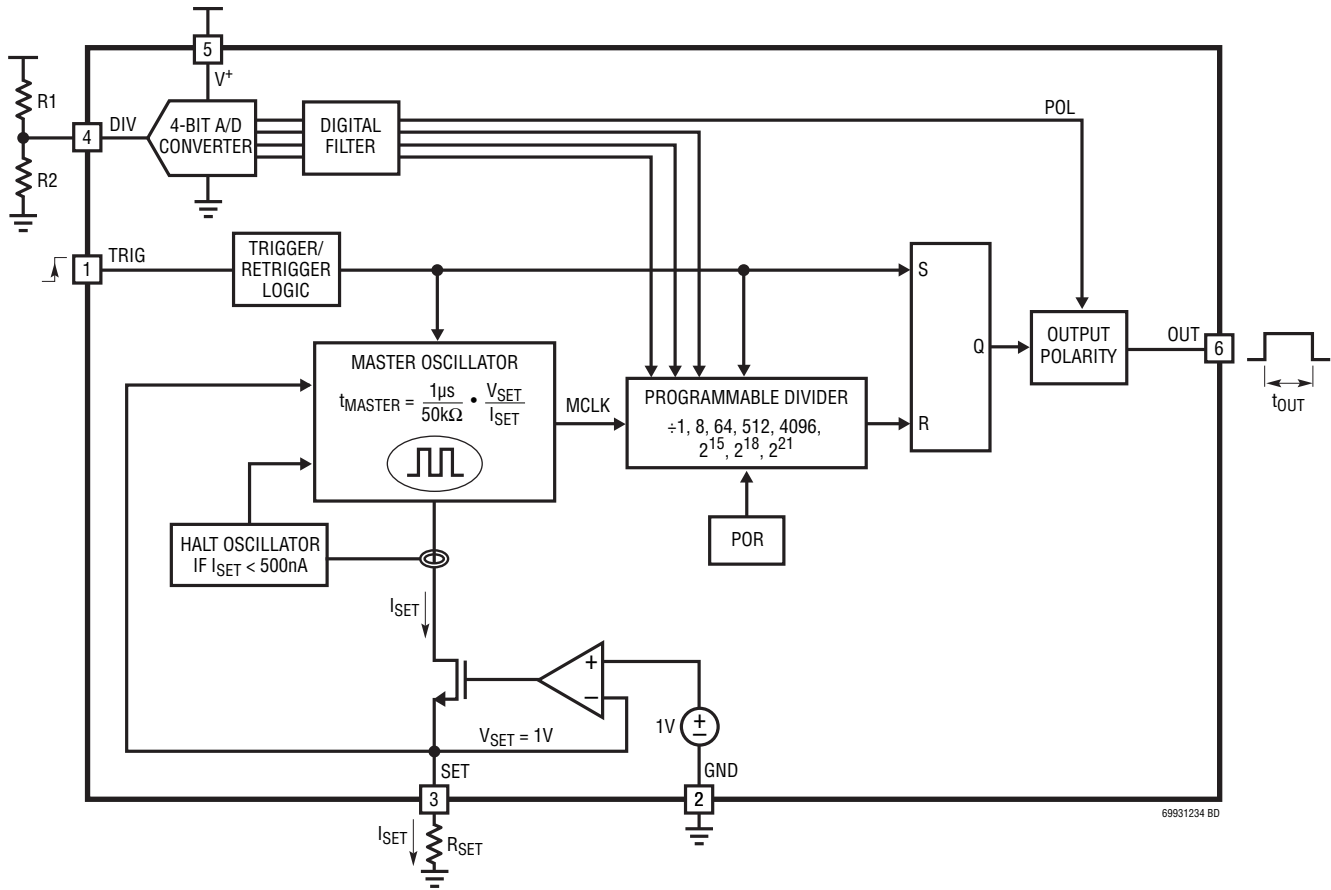

OPERATION

The LTC6993 is built around a master oscillator with a 1μs minimum period. The oscillator is controlled by the SET pin current (I_{SET}) and voltage (V_{SET}), with a 1μs/50kΩ conversion factor that is accurate to ±1.7% under typical conditions.

$$t_{MASTER} = \frac{1\mu s}{50k\Omega} \cdot \frac{V_{SET}}{I_{SET}}$$

A feedback loop maintains V_{SET} at 1V ±30mV, leaving I_{SET} as the primary means of controlling the pulse width. The simplest way to generate I_{SET} is to connect a resistor (R_{SET}) between SET and GND, such that $I_{SET} = V_{SET}/R_{SET}$. The master oscillator equation reduces to:

$$t_{MASTER} = 1\mu s \cdot \frac{R_{SET}}{50k\Omega}$$

From this equation, it is clear that V_{SET} drift will not affect the pulse width when using a single program resistor (R_{SET}). Error sources are limited to R_{SET} tolerance and the inherent pulse width accuracy Δt_{OUT} of the LTC6993.

R_{SET} may range from 50k to 800k (equivalent to I_{SET} between 1.25μA and 20μA).

A trigger signal (rising or falling edge on TRIG pin) latches the output to the active state, beginning the output pulse. At the same time, the master oscillator is enabled to time the duration of the output pulse. When the desired pulse width is reached, the master oscillator resets the output latch.

The LTC6993 also includes a programmable frequency divider which can further divide the frequency by 1, 8, 64, 512, 4096, 2^{15} , 2^{18} or 2^{21} . This extends the pulse width duration by those same factors. The divider ratio N_{DIV} is set by a resistor divider attached to the DIV pin.

$$t_{OUT} = \frac{N_{DIV}}{50k\Omega} \cdot \frac{V_{SET}}{I_{SET}} \cdot 1\mu s$$

With R_{SET} in place of V_{SET}/I_{SET} the equation reduces to:

$$t_{OUT} = \frac{N_{DIV} \cdot R_{SET}}{50k\Omega} \cdot 1\mu s$$

DIVCODE

The DIV pin connects to an internal, V^+ referenced 4-bit A/D converter that determines the DIVCODE value. DIVCODE programs two settings on the LTC6993:

1. DIVCODE determines the frequency divider setting, N_{DIV} .
2. DIVCODE determines the polarity of OUT pin, via the POL bit.

V_{DIV} may be generated by a resistor divider between V^+ and GND as shown in Figure 1.



Figure 1. Simple Technique for Setting DIVCODE

Table 1 offers recommended 1% resistor values that accurately produce the correct voltage division as well as the corresponding N_{DIV} and POL values for the recommended resistor pairs. Other values may be used as long as:

1. The V_{DIV}/V^+ ratio is accurate to ±1.5% (including resistor tolerances and temperature effects).
2. The driving impedance ($R1 || R2$) does not exceed 500kΩ.

If the voltage is generated by other means (i.e., the output of a DAC) it must track the V^+ supply voltage. The last column in Table 1 shows the ideal ratio of V_{DIV} to the supply voltage, which can also be calculated as:

$$\frac{V_{DIV}}{V^+} = \frac{DIVCODE + 0.5}{16} \pm 1.5\%$$

For example, if the supply is 3.3V and the desired DIVCODE is 4, $V_{DIV} = 0.281 \cdot 3.3V = 928mV \pm 50mV$.

Figure 2 illustrates the information in Table 1, showing that N_{DIV} is symmetric around the DIVCODE midpoint.

OPERATION

Table 1. DIVCODE Programming

DIVCODE	POL	N _{DIV}	Recommended t _{OUT}	R1 (k)	R2 (k)	V _{DIV} /V ⁺
0	0	1	1μs to 16μs	Open	Short	≤ 0.03125 ±0.015
1	0	8	8μs to 128μs	976	102	0.09375 ±0.015
2	0	64	64μs to 1.024ms	976	182	0.15625 ±0.015
3	0	512	512μs to 8.192ms	1000	280	0.21875 ±0.015
4	0	4,096	4.096ms to 65.54ms	1000	392	0.28125 ±0.015
5	0	32,768	32.77ms to 524.3ms	1000	523	0.34375 ±0.015
6	0	262,144	262.1ms to 4.194sec	1000	681	0.40625 ±0.015
7	0	2,097,152	2.097sec to 33.55sec	1000	887	0.46875 ±0.015
8	1	2,097,152	2.097sec to 33.55sec	887	1000	0.53125 ±0.015
9	1	262,144	262.1ms to 4.194sec	681	1000	0.59375 ±0.015
10	1	32,768	32.77ms to 524.3ms	523	1000	0.65625 ±0.015
11	1	4,096	4.096ms to 65.54ms	392	1000	0.71875 ±0.015
12	1	512	512μs to 8.192ms	280	1000	0.78125 ±0.015
13	1	64	64μs to 1.024ms	182	976	0.84375 ±0.015
14	1	8	8μs to 128μs	102	976	0.90625 ±0.015
15	1	1	1μs to 16μs	Short	Open	≥ 0.96875 ±0.015



Figure 2. Pulse Width Range and POL Bit vs DIVCODE

OPERATION

Monostable Multivibrator (One Shot)

The LTC6993 is a monostable multivibrator. A trigger signal on the TRIG input will force the output to the active (unstable) state for a programmable duration. This type of circuit is commonly referred to as a one-shot pulse generator.

Figure 3 details the basic operation. A rising edge on the TRIG pin initiates the output pulse. The pulse width (t_{OUT}) is determined by the N_{DIV} setting and by the resistor (R_{SET}) connected to the SET pin. Subsequent rising edges on TRIG have no effect until the completion of the one shot and for a short rearming time (t_{ARM}) thereafter. To ensure proper operation, positive and negative TRIG pulses should be at least t_{WIDTH} wide.

The LTC6993-2 and LTC6993-4 allow the output pulse to be “retriggered”. As shown in Figure 4, the output pulse will stay high until t_{OUT} after the last rising-edge on TRIG. Successive trigger signals can extend the pulse width indefinitely. Consecutive trigger signals must be separated by t_{RETRIG} to be recognized.

Negative Trigger Versions

In addition to the retrigger option, the LTC6993 family also includes negative input (falling-edge) versions. These four combinations are detailed in Table 2.

Table 2. Retrigger and Input Polarity Options

DEVICE	INPUT POLARITY	RETRIGGER
LTC6993-1	Rising-Edge	No
LTC6993-2	Rising-Edge	Yes
LTC6993-3	Falling-Edge	No
LTC6993-4	Falling-Edge	Yes

Output Polarity (POL Bit)

Each variety of LTC6993 also offers the ability to invert the output, producing negative pulses. This option is programmed, along with N_{DIV} , by the choice of DIVCODE. (The previous section describes how to program DIVCODE using the DIV pin).



Figure 3. Non-Retriggering Timing Diagram (LTC6993-1, POL = 0)



Figure 4. Retriggering Timing Diagram (LTC6993-2, POL = 0)

OPERATION

Changing DIVCODE After Start-Up

Following start-up, the A/D converter will continue monitoring V_{DIV} for changes. Changes to DIVCODE will be recognized slowly, as the LTC6993 places a priority on eliminating any “wandering” in the DIVCODE. The typical delay depends on the difference between the old and new DIVCODE settings and is proportional to the master oscillator period.

$$t_{DIVCODE} = 16 \cdot (\Delta DIVCODE + 6) \cdot t_{MASTER}$$

A change in DIVCODE will not be recognized until it is stable, and will not pass through intermediate codes. A digital filter is used to guarantee the DIVCODE has settled to a new value before making changes to the output. However, if the output pulse is active during the transition, the pulse width can take on a value between the two settings.



Figure 5a. DIVCODE Change from 0 to 2



Figure 5b. DIVCODE Change from 2 to 0

Start-Up Time

When power is first applied, the power-on reset (POR) circuit will initiate the start-up time, t_{START} . The OUT pin is held low during this time. The typical value for t_{START} ranges from 0.5ms to 8ms depending on the master oscillator frequency (independent of N_{DIV}):

$$t_{START(TYP)} = 500 \cdot t_{MASTER}$$

During start-up, the DIV pin A/D converter must determine the correct DIVCODE before an output pulse can be generated. The start-up time may increase if the supply or DIV pin voltages are not stable. For this reason, it is recommended to minimize the capacitance on the DIV pin so it will properly track V^+ . Less than 100pF will not extend the start-up time.

The DIVCODE setting is recognized at the end of the startup up. If $POL = 1$, the output will transition high. Otherwise (if $POL = 0$) OUT simply remains low. At this point, the LTC6993 is ready to respond to rising/falling edges on the TRIG input.



Figure 6. Start-Up Timing Diagram

APPLICATIONS INFORMATION

Basic Operation

The simplest and most accurate method to program the LTC6993 is to use a single resistor, R_{SET} , between the SET and GND pins. The design procedure is a four step process. Alternatively, Linear Technology offers the easy-to-use TimerBlox Designer tool to quickly design any LTC6993 based circuit. Download the free TimerBlox Designer software at www.linear.com/timerblox.

Step 1: Select the POL Bit Setting.

The LTC6993 can generate positive or negative output pulses, depending on the setting of the POL bit. The POL bit is the DIVCODE MSB, so any $DIVCODE \geq 8$ has $POL = 1$ and produces active-low pulses.

Step 2: Select LTC6993 Version.

Two input-related choices dictate the proper LTC6993 for a given application:

- Is TRIG a rising or falling-edge input?
- Should retriggering be allowed?

Use Table 2 to select a particular variety of LTC6993.

Step 3: Select the N_{DIV} Frequency Divider Value.

As explained earlier, the voltage on the DIV pin sets the DIVCODE which determines both the POL bit and the N_{DIV} value. For a given output pulse width (t_{OUT}), N_{DIV} should be selected to be within the following range:

$$\frac{t_{OUT}}{16\mu s} \leq N_{DIV} \leq \frac{t_{OUT}}{1\mu s} \quad (1)$$

To minimize supply current, choose the lowest N_{DIV} value. However, in some cases a higher value for N_{DIV} will provide better accuracy (see Electrical Characteristics).

Table 1 can also be used to select the appropriate N_{DIV} values for the desired t_{OUT} .

With POL already chosen, this completes the selection of DIVCODE. Use Table 1 to select the proper resistor divider or V_{DIV}/V^+ ratio to apply to the DIV pin.

Step 4: Calculate and Select R_{SET} .

The final step is to calculate the correct value for R_{SET} using the following equation:

$$R_{SET} = \frac{50k}{1\mu s} \cdot \frac{t_{OUT}}{N_{DIV}} \quad (2)$$

Select the standard resistor value closest to the calculated value.

Example: Design a one-shot circuit that satisfies the following requirements:

- $t_{OUT} = 100\mu s$
- Negative Output Pulse
- Rising-Edge Trigger Input
- Retriggerable Input
- Minimum power consumption

Step 1: Select the POL Bit Setting.

For inverted (negative) output pulse, choose $POL = 1$.

Step 2: Select the LTC6993 Version.

A rising-edge retriggerable input requires the LTC6993-2.

Step 3: Select the N_{DIV} Frequency Divider Value.

Choose an N_{DIV} value that meets the requirements of Equation (1), using $t_{OUT} = 100\mu s$:

$$6.25 \leq N_{DIV} \leq 100$$

Potential settings for N_{DIV} include 8 and 64. $N_{DIV} = 8$ is the best choice, as it minimizes supply current by using a large R_{SET} resistor. $POL = 1$ and $N_{DIV} = 8$ requires $DIVCODE = 14$. Using Table 1, choose $R1 = 102k$ and $R2 = 976k$ values to program $DIVCODE = 14$.

Step 4: Select R_{SET} .

Calculate the correct value for R_{SET} using Equation (2):

$$R_{SET} = \frac{50k}{1\mu s} \cdot \frac{100\mu s}{8} = 625k$$

APPLICATIONS INFORMATION

Since 625k is not available as a standard 1% resistor, substitute 619k if a -0.97% shift in t_{OUT} is acceptable. Otherwise, select a parallel or series pair of resistors such as 309k and 316k to attain a more precise resistance.

The completed design is shown in Figure 7.



Figure 7. 100µs Negative Pulse Generator

Voltage-Controlled Pulse Width

With one additional resistor, the LTC6993 output pulse width can be manipulated by an external voltage. As shown in Figure 8, voltage V_{CTRL} sources/sinks a current through R_{MOD} to vary the I_{SET} current, which in turn modulates the pulse width as described in Equation (3).

$$t_{OUT} = \frac{N_{DIV} \cdot R_{MOD}}{50k\Omega} \cdot \frac{1\mu s}{1 + \frac{R_{MOD}}{R_{SET}} - \frac{V_{CTRL}}{V_{SET}}} \quad (3)$$



Figure 8. Voltage-Controlled Pulse Width

Digital Pulse Width Control

The control voltage can be generated by a DAC (digital-to-analog converter), resulting in a digitally-controlled pulse width. Many DACs allow for the use of an external reference. If such a DAC is used to provide the V_{CTRL} voltage, the V_{SET} dependency can be eliminated by buffering V_{SET} and using it as the DAC's reference voltage, as shown in Figure 9. The DAC's output voltage now tracks any V_{SET} variation and eliminates it as an error source. The SET pin cannot be tied directly to the reference input of the DAC because the current drawn by the DAC's REF input would affect the pulse width.

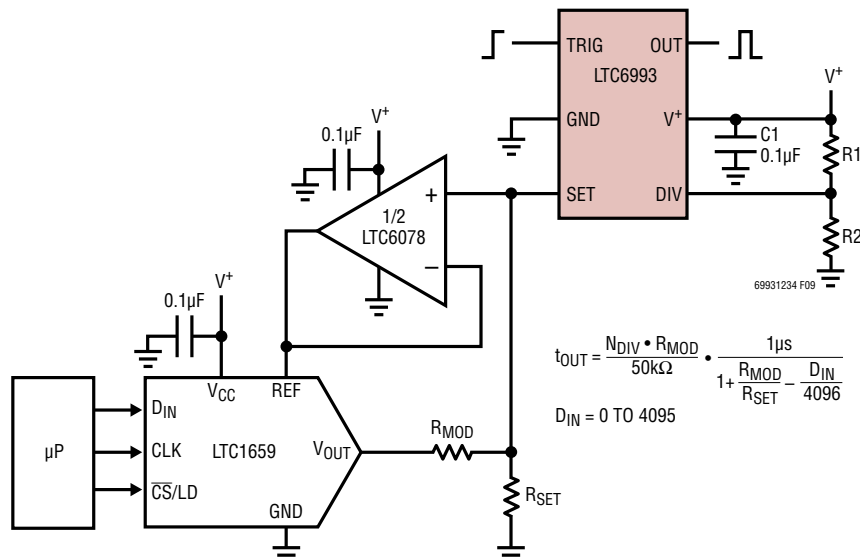

Figure 9. Digitally Controlled Pulse Width

APPLICATIONS INFORMATION

I_{SET} Extremes (Master Oscillator Frequency Extremes)

When operating with I_{SET} outside of the recommended $1.25\mu\text{A}$ to $20\mu\text{A}$ range, the master oscillator operates outside of the 62.5kHz to 1MHz range in which it is most accurate.

The oscillator will still function with reduced accuracy for $I_{SET} < 1.25\mu\text{A}$. At approximately 500nA , the oscillator will stop. Under this condition, the output pulse can still be initiated, but will not terminate until I_{SET} increases and the master oscillator starts again.

At the other extreme, it is not recommended to operate the master oscillator beyond 2MHz because the accuracy of the DIV pin ADC will suffer.

Settling Time

Following a $2\times$ or $0.5\times$ step change in I_{SET} , the output pulse width takes approximately six master clock cycles ($6 \cdot t_{MASTER}$) to settle to within 1% of the final value. An example is shown in Figure 10, using the circuit in Figure 8.



Figure 10. Typical Settling Time

Coupling Error

The current sourced by the SET pin is used to bias the internal master oscillator. The LTC6993 responds to changes in I_{SET} almost immediately, which provides excellent settling time. However, this fast response also makes the SET pin sensitive to coupling from digital signals, such as the TRIG input.

Even an excellent layout will allow *some* coupling between TRIG and SET. Additional error is included in the specified accuracy for $N_{DIV} = 1$ to account for this. Figure 11 shows that ± 1 supply variation is dependent on coupling from rising or falling trigger inputs and, to a lesser extent, output polarity.

A very poor layout can actually degrade performance further. The PCB layout should avoid routing SET next to TRIG (or any other fast-edge, wide-swing signal).



Figure 11. t_{OUT} Drift vs Supply Voltage

APPLICATIONS INFORMATION

Power Supply Current

The Electrical Characteristics table specifies the supply current while the part is idle (waiting to be triggered). $I_{S(IDLE)}$ varies with the programmed t_{OUT} and the supply voltage. Once triggered, the instantaneous supply current increases to $I_{S(ACTIVE)}$ while the timing circuit is active.

$$I_{S(ACTIVE)} = I_{S(IDLE)} + \Delta I_{S(ACTIVE)}$$

The *average* increase in supply current $\Delta I_{S(ACTIVE)}$ depends on the output duty cycle (or negative duty cycle, if $POL = 1$), since that represents the percentage of time that the circuit is active. $I_{S(IDLE)}$ and $\Delta I_{S(ACTIVE)}$ can be estimated using the equations in Table 2.

Figure 12 shows how the supply current increases from $I_{S(IDLE)}$ as the input frequency increases. The increase is smaller at higher N_{DIV} settings.



Figure 12. $I_{S(ACTIVE)}$ vs Output Duty Cycle

Table 2. Typical Supply Current

CONDITION	TYPICAL $I_{S(IDLE)}$	TYPICAL $\Delta I_{S(ACTIVE)}$ *
$N_{DIV} \leq 64$	$\frac{V^+ \cdot (N_{DIV} \cdot 7pF + 4pF)}{t_{OUT}} + \frac{V^+}{500k\Omega} + 2.2 \cdot I_{SET} + 5I$	$V^+ \cdot \frac{Duty\ Cycle}{t_{OUT}} \cdot (N_{DIV} \cdot 5pF + 18pF + C_{LO})$
$N_{DIV} \geq 512$	$\frac{V^+ \cdot N_{DIV} \cdot 7pF}{t_{OUT}} + \frac{V^+}{500k\Omega} + 1.8 \cdot I_{SET} + 50$	$V^+ \cdot \frac{Duty\ Cycle}{t_{OUT}} \cdot C_{LOA}$

*Ignoring resistive loads (assumes $R_{LOAD} = \infty$)

APPLICATIONS INFORMATION

Supply Bypassing and PCB Layout Guidelines

The LTC6993 is an accurate monostable multivibrator when used in the appropriate manner. The part is simple to use and by following a few rules, the expected performance is easily achieved. Adequate supply bypassing and proper PCB layout are important to ensure this.

Figure 13 shows example PCB layouts for both the SOT-23 and DCB packages using 0603 sized passive components. The layouts assume a two layer board with a ground plane layer beneath and around the LTC6993. These layouts are a guide and need not be followed exactly.

1. Connect the bypass capacitor, C1, directly to the V⁺ and GND pins using a low inductance path. The connection from C1 to the V⁺ pin is easily done directly on the top layer. For the DCB package, C1's connection to GND is also simply done on the top layer. For the SOT-23, OUT can be routed through the C1 pads to allow a good C1 GND connection. If the PCB design rules do not allow that, C1's GND connection can be accomplished through multiple vias to the ground plane. Multiple vias for both the GND pin connection to the ground plane and the

C1 connection to the ground plane are recommended to minimize the inductance. Capacitor C1 should be a 0.1μF ceramic capacitor.

2. Place all passive components on the top side of the board. This minimizes trace inductance.
3. Place R_{SET} as close as possible to the SET pin and make a direct, short connection. The SET pin is a current summing node and currents injected into this pin directly modulate the output pulse width. Having a short connection minimizes the exposure to signal pickup.
4. Connect R_{SET} directly to the GND pin. Using a long path or vias to the ground plane will not have a significant affect on accuracy, but a direct, short connection is recommended and easy to apply.
5. Use a ground trace to shield the SET pin. This provides another layer of protection from radiated signals.
6. Place R1 and R2 close to the DIV pin. A direct, short connection to the DIV pin minimizes the external signal coupling.

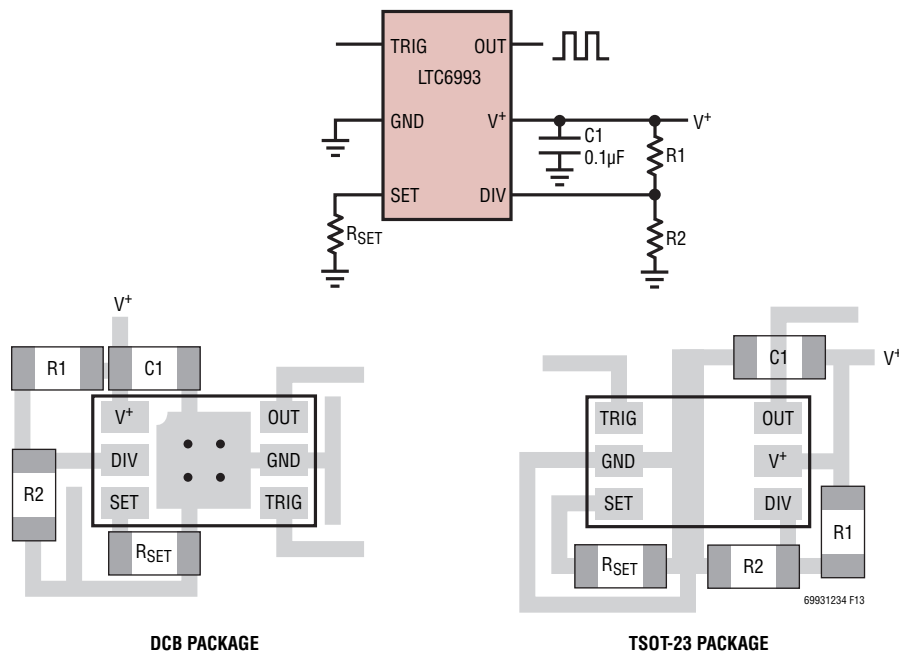
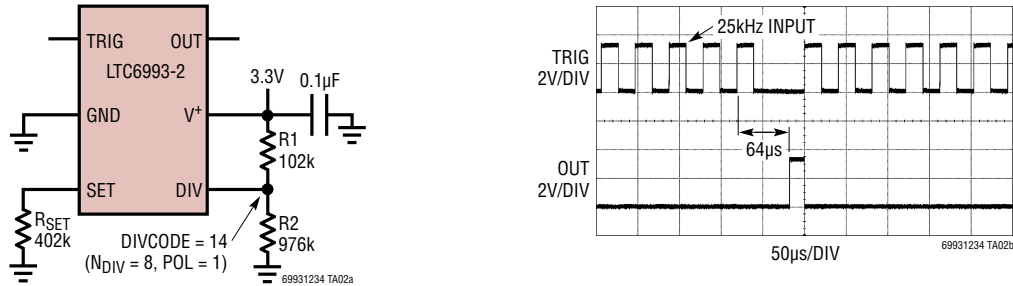

Figure 13. Supply Bypassing and PCB Layout

TYPICAL APPLICATIONS

Missing Pulse Detector



Use retriggerable one shot with output inverted. Output remains low as long as retrigger occurs within $t_{OUT} = 64\mu s$.

1.5ms Radio Control Servo Reference Pulse Generator



Pulse Delay Generator



TYPICAL APPLICATIONS

RC Servo Pulse Generator Controlled Retrigger Lockout Time Interval

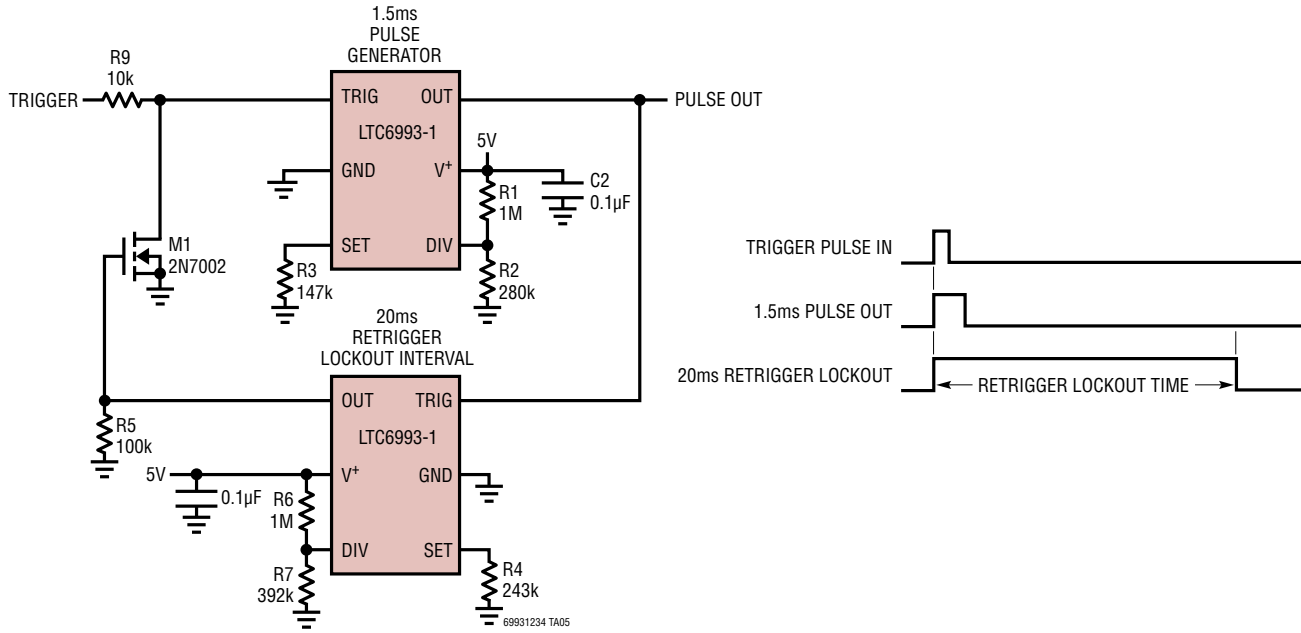

Staircase Generator with Reset

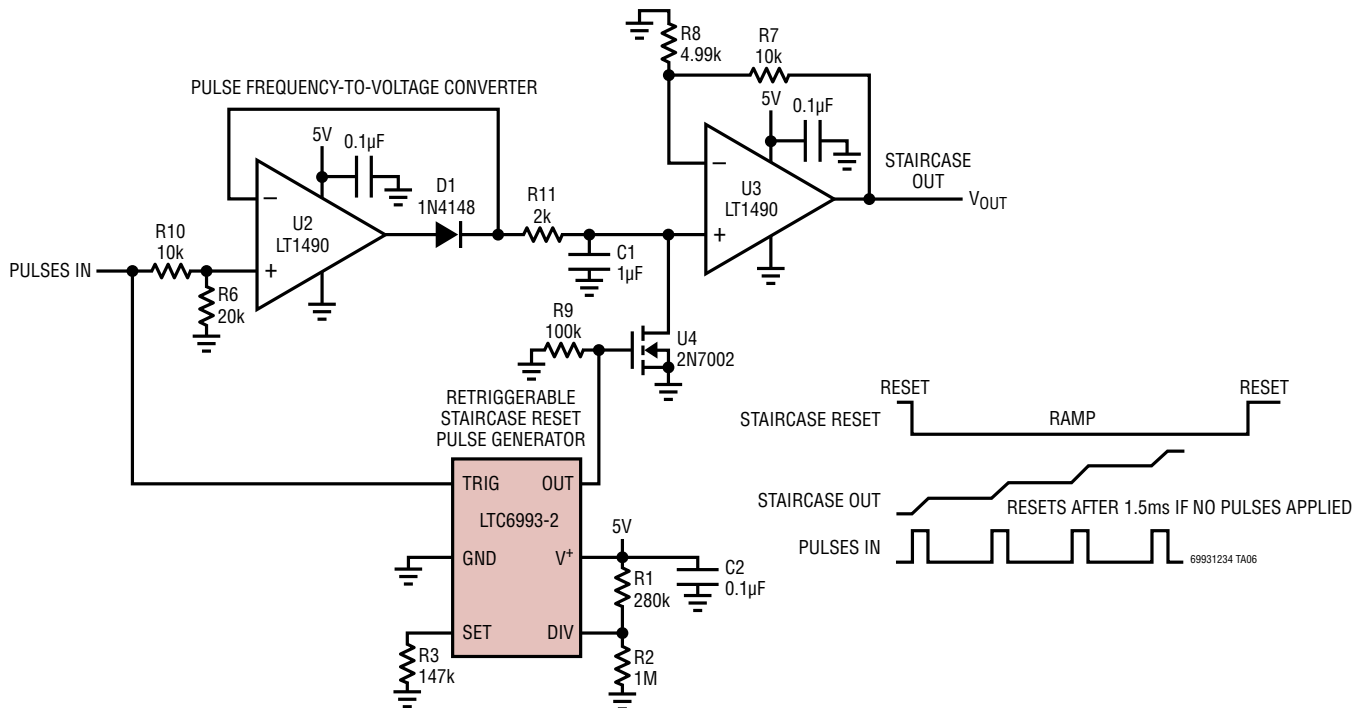

TYPICAL APPLICATIONS

Pulse Stretcher



TYPICAL APPLICATIONS

On-Time Programmable Pulsed Solenoid Driver

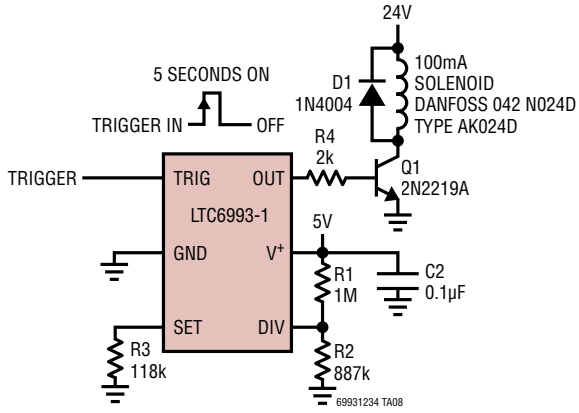

Safety Time-Out Relay Driver



PACKAGE DESCRIPTION

Please refer to <http://www.linear.com/product/LTC6993#packaging> for the most recent package drawings.

DCB Package
6-Lead Plastic DFN (2mm × 3mm)
(Reference LTC DWG # 05-08-1715 Rev A)

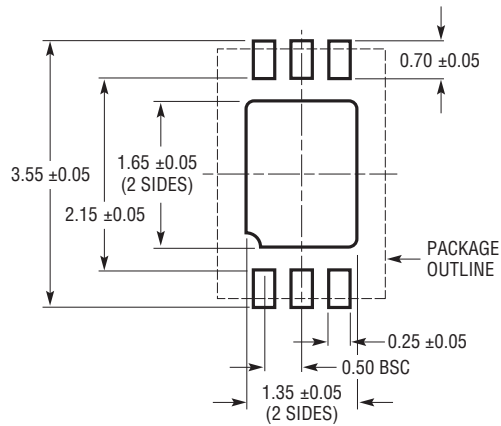

RECOMMENDED SOLDER PAD PITCH AND DIMENSIONS

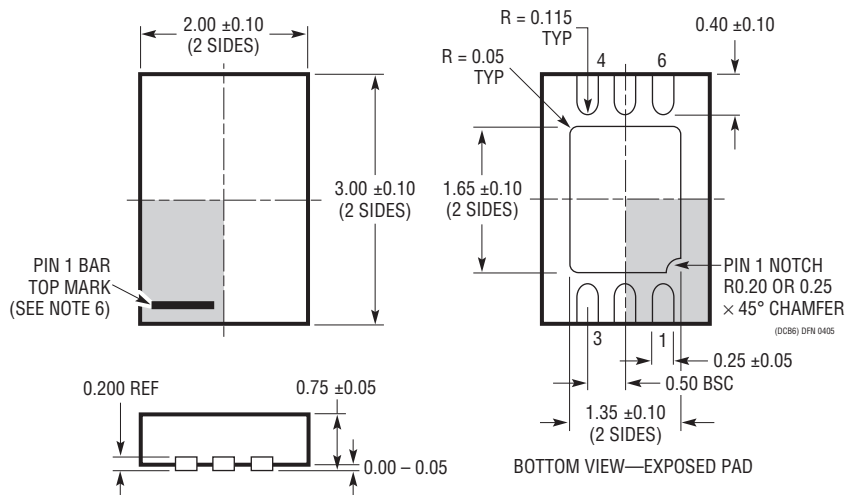

NOTE:

1. DRAWING TO BE MADE A JEDEC PACKAGE OUTLINE M0-229 VARIATION OF (TBD)
2. DRAWING NOT TO SCALE
3. ALL DIMENSIONS ARE IN MILLIMETERS
4. DIMENSIONS OF EXPOSED PAD ON BOTTOM OF PACKAGE DO NOT INCLUDE MOLD FLASH. MOLD FLASH, IF PRESENT, SHALL NOT EXCEED 0.15mm ON ANY SIDE
5. EXPOSED PAD SHALL BE SOLDER PLATED
6. SHADED AREA IS ONLY A REFERENCE FOR PIN 1 LOCATION ON THE TOP AND BOTTOM OF PACKAGE

LTC6993-1/LTC6993-2 LTC6993-3/LTC6993-4

PACKAGE DESCRIPTION

Please refer to <http://www.linear.com/product/LTC6993#packaging> for the most recent package drawings.

S6 Package
6-Lead Plastic TSOT-23
(Reference LTC DWG # 05-08-1636)



- NOTE:
1. DIMENSIONS ARE IN MILLIMETERS
 2. DRAWING NOT TO SCALE
 3. DIMENSIONS ARE INCLUSIVE OF PLATING
 4. DIMENSIONS ARE EXCLUSIVE OF MOLD FLASH AND METAL BURR
 5. MOLD FLASH SHALL NOT EXCEED 0.254mm
 6. JEDEC PACKAGE REFERENCE IS MO-193

S6 TSOT-23 0302

REVISION HISTORY

REV	DATE	DESCRIPTION	PAGE NUMBER
A	7/11	Revised Description section	1 to 3
		Added text to Basic Operation paragraph in Applications Information section	15
B	1/12	Added MP-grade	1, 2, 3, 5
C	11/15	Web Links Added	All
		Conditions for VOH Specification from $V^+ = 5.5V$, $I_{OUT} = -16mA$, changed to $V^+ = 3.3V$, $I_{OUT} = -10mA$	4
		Correction to graph " t_{OUT} vs Supply Voltage ($N_{DIV} - 1$, Rising Edge)". Curves were offset low, and corrected upward.	6
		Correction to circuit "Safety Time-Out Relay Driver", R4 changed from 15k to 10k.	23

TYPICAL APPLICATION

Consecutive Test Sequencer



RELATED PARTS

PART NUMBER	DESCRIPTION	COMMENTS
LTC1799	1MHz to 33MHz ThinSOT Silicon Oscillator	Wide Frequency Range
LTC6900	1MHz to 20MHz ThinSOT Silicon Oscillator	Low Power, Wide Frequency Range
LTC6906/LTC6907	10kHz to 1MHz or 40kHz ThinSOT Silicon Oscillator	Micropower, $I_{SUPPLY} = 35\mu A$ at 400kHz
LTC6930	Fixed Frequency Oscillator, 32.768kHz to 8.192MHz	0.09% Accuracy, 110 μs Start-Up Time, 105 μA at 32kHz
LTC6990	TimerBlox: Voltage-Controlled Silicon Oscillator	Fixed-Frequency or Voltage-Controlled Operation
LTC6991	TimerBlox: Resettable Low Frequency Oscillator	Clock Periods up to 9.5 hours
LTC6992	TimerBlox: Voltage-Controlled Pulse Width Modulator (PWM)	Simple PWM with Wide Frequency Range
LTC6994	TimerBlox: Delay Block/Debouncer	Delay Rising Edge, Falling Edge or Both Edges



Компания «ЭлектроПласт» предлагает заключение долгосрочных отношений при поставках импортных электронных компонентов на взаимовыгодных условиях!

Наши преимущества:

- Оперативные поставки широкого спектра электронных компонентов отечественного и импортного производства напрямую от производителей и с крупнейших мировых складов;
- Поставка более 17-ти миллионов наименований электронных компонентов;
- Поставка сложных, дефицитных, либо снятых с производства позиций;
- Оперативные сроки поставки под заказ (от 5 рабочих дней);
- Экспресс доставка в любую точку России;
- Техническая поддержка проекта, помощь в подборе аналогов, поставка прототипов;
- Система менеджмента качества сертифицирована по Международному стандарту ISO 9001;
- Лицензия ФСБ на осуществление работ с использованием сведений, составляющих государственную тайну;
- Поставка специализированных компонентов (Xilinx, Altera, Analog Devices, Intersil, Interpoint, Microsemi, Aeroflex, Peregrine, Syfer, Eurofarad, Texas Instrument, Miteq, Cobham, E2V, MA-COM, Hittite, Mini-Circuits, General Dynamics и др.);

Помимо этого, одним из направлений компании «ЭлектроПласт» является направление «Источники питания». Мы предлагаем Вам помощь Конструкторского отдела:

- Подбор оптимального решения, техническое обоснование при выборе компонента;
- Подбор аналогов;
- Консультации по применению компонента;
- Поставка образцов и прототипов;
- Техническая поддержка проекта;
- Защита от снятия компонента с производства.



Как с нами связаться

Телефон: 8 (812) 309 58 32 (многоканальный)

Факс: 8 (812) 320-02-42

Электронная почта: org@eplast1.ru

Адрес: 198099, г. Санкт-Петербург, ул. Калинина, дом 2, корпус 4, литера А.