

IR Receiver Module

RPM5500 series

RPM5500 series are remote control receiver modules. Small-sized, light-weight, and low current consumption modules have been achieved by using resin mold.

●Applications

All household electric appliances such as TV, DVD, air conditioner and audio equipment.

●Features

- 1) Small size, SMD type.
- 2) Low current consumption. (0.95mA Typ.)
- 3) High ripple rejection.
- 4) Top view package type & Side view package type.

●RPM5500 series

| Sub carrier frequency | SIDE VIEW | TOP VIEW |
|-----------------------|-------------|-------------|
| 36.7kHz | RPM5537-H14 | RPM5537-H12 |
| 37.9kHz | RPM5538-H14 | RPM5538-H12 |
| 40.0kHz | RPM5540-H14 | RPM5540-H12 |

●Absolute maximum ratings (Ta = 25°C)

| Parameter | Symbol | Limits | Unit |
|-----------------------|------------------|-------------|------|
| Supply Voltage | V _{cc} | 6.3 | V |
| Storage temperature | T _{stg} | -30 to +100 | °C |
| Operating temperature | T _{opr} | -10 to +75 | °C |
| Output Current | I _o | 2.0 | mA |

●Recommended operating conditions (Ta = 25°C)

| Parameter | Symbol | Min. | Typ. | Max. | Unit |
|----------------|-----------------|------|------|------|------|
| Supply Voltage | V _{cc} | 4.5 | 5.0 | 5.5 | V |

Photo Link Module

●Block diagram

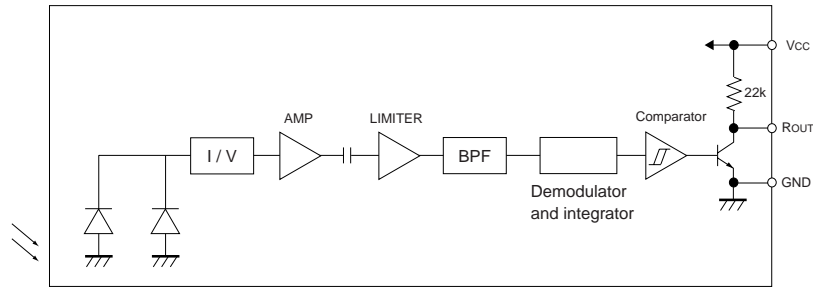

●Terminal description

| Pin No. | Pin name | Function |
|---------|------------------|-----------------|
| 1 | V _{CC} | POWER SUPPLY |
| 2 | GND | GROUND |
| 3 | GND | GROUND |
| 4 | GND | GROUND |
| 5 | R _{OUT} | OUTPUT TERMINAL |
| 6 | GND | GROUND |
| 7 | GND | GROUND |

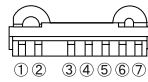

●Electrical, Optical characteristics (Unless otherwise noted, Ta = 25°C V_{CC}=5V)

| Parameter | Symbol | Min. | Typ. | Max. | Unit | Conditions |
|---------------------------|------------------|------|------|------|------|---|
| Consumption Current | I _{CC} | – | 0.95 | 1.5 | mA | No outside light, No signal input |
| Effective Distance | L | 7 | 12 | – | m | Outer light condition E _e < 10 (lx) *1 |
| High Level Output Voltage | V _H | 4.5 | – | – | V | *1 |
| Low Level Output Voltage | V _L | – | – | 0.5 | V | I _{sink} ≤ 200μA *1 |
| ON Pulse Width | T _{ON} | 400 | 600 | 800 | μs | Outer light condition E _e < 10 (lx) *1 |
| OFF Pulse Width | T _{OFF} | 400 | 600 | 800 | μs | Outer light condition E _e < 10 (lx) *1 |
| Center frequency | f _o | – | *3 | – | kHz | |
| Horizontal half angle | θ 1/2 | – | 42 | – | deg | *2 |
| Vertical half angle | θ 1/2 | – | 38 | – | deg | *2 |

*1 600/600μs burst wave is transmitted by standard transmitter. However, it must be measured after the initial transmission pulse is 10 pulse.
 *2 It is an angle when the linear arrival distance become half.
 *3 Three types of frequencies : 36.7, 37.9, 40kHz.

● Measurement Conditions

(1) Transmit signal

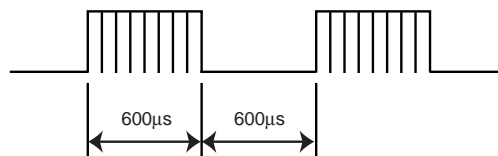

Carrier frequency=f_o, Duty=50%

Fig.1 Transmit signal

Photo Link Module

(2) Standard transmitter

$\lambda_{\text{peak}}=940\text{nm}$
 $\lambda_{\Delta}=40\text{nm}$

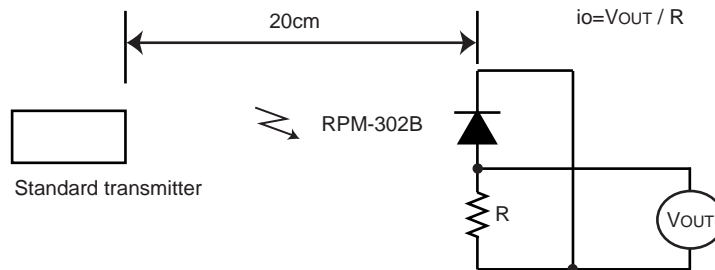

Fig.2 Measurement of standard transmitter proofreading

When standard transmitter output the signal at Fig.1 standard photodiode output become $i_o=5\mu\text{Ap-p}$ under the measurement condition Fig.2.

(The radiant intensity of standard transmitter : $50\text{mW} / \text{sr}$)

RPM-302B : standard photodiode has short current $I_{sc}=27\mu\text{A}$ at $E=1000(\text{lx})$
 (using CIE standard light source A)

(3) Measurement effective distance, horizontal & vertical half angle

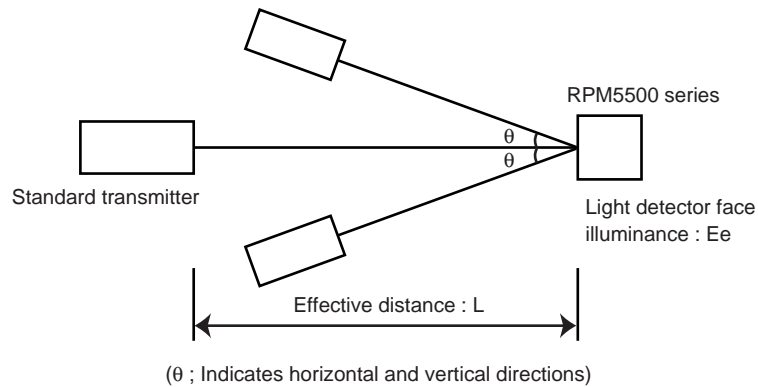

Fig.3 Measurement condition for effective distance

Effective distance L : Effective distance at $\theta=0^\circ$ Fig.3
 Horizontal & vertical half angle θ : The angle which effective distance became 50% of L.

Photo Link Module

(4) Output signal

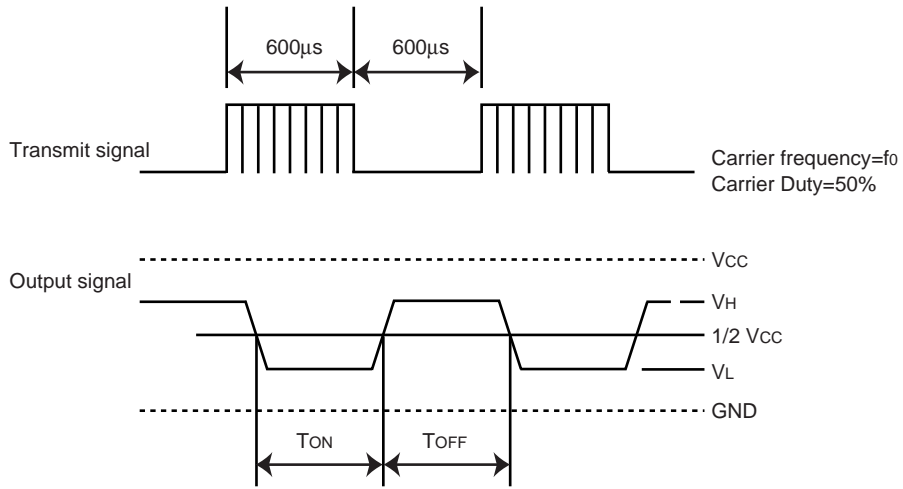

Fig.4

(5) Measurement circuit for the output voltage and the consumption current

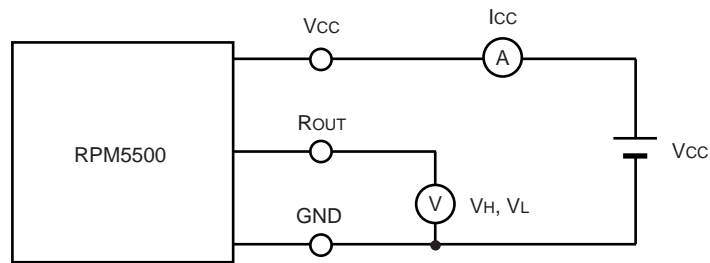

Fig.5

Photo Link Module

●Notes

- (1) All characteristics of the receiver in this specification are specified by supplying burst wave form (Fig.1) with ROHM standard transmitter (Fig.2).
If in case of other burst wave form will be used, please check these spec. Carefully under the evaluations.
- (2) When the receiver will be used as the wire-less remote controller, please use the signal method the signal format which refer to "Measures to prevent malfunctioning of IR remote-controlled electric home appliances". (Published July 1987 by Association of Electric Home Appliances)
If using other signal method, signal format, (ex: signal format which not including the leader signal) the receiver might have chances to miss-function.
- (3) Please set up transmitter's carrier frequency as same as the receiver's f_0 frequency. Otherwise error might be occurred.
- (4) If transmission signal has non-continues carrier, error might be occurred. Continuous carrier is necessary.



- (5) The receiver was designed to use as in-door use only.
Therefore, please understand that the receiver cannot cover all characteristics, in case of using it out-door.
- (6) Noise environment (Light noise from inverter Lamp, and other kind of Lamps, Power ripple, electromagnetic noise from power circuit, and etc) may cause a reduced effective distance.
- (7) The receiver may not work properly if receiving signal judgement is done by single pulse due to the surrounding / environmental noises.
To prevent such misjudgement, please make sure that the receiver is set up to work only when receiving series of coded signal.
- (8) Emitting unit (remote control transmitter) has to be considered about its emitting device function, characteristics and characteristics of the receiver.
- (9) Please connect 'Holder' on to the 'Ground (GND)' of PCB. If the holder is not connected to the GND, there is a possibility of worsening the characteristics of product.
- (10) Do not supply unnecessary stress to lead.
- (11) Please pay careful attention to the lens.
It might have a chance to miss-function when the lens get dust or dirty. And also please do not touch the lens.
- (12) In order to prevent products from ESD, human body and solder iron, etc. are required to be grounded.

Photo Link Module

●Electrical and optical characteristics curves

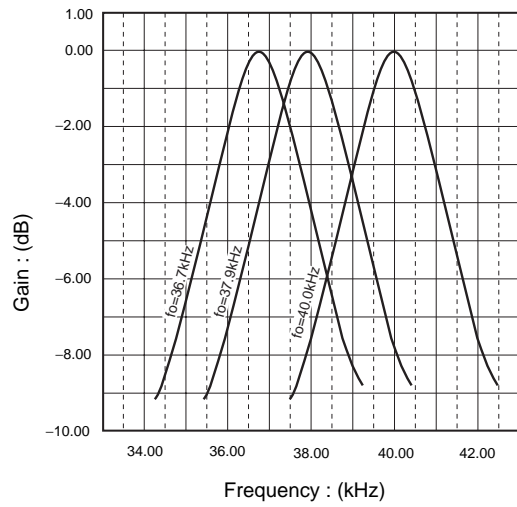

Fig.6 BPF characteristic

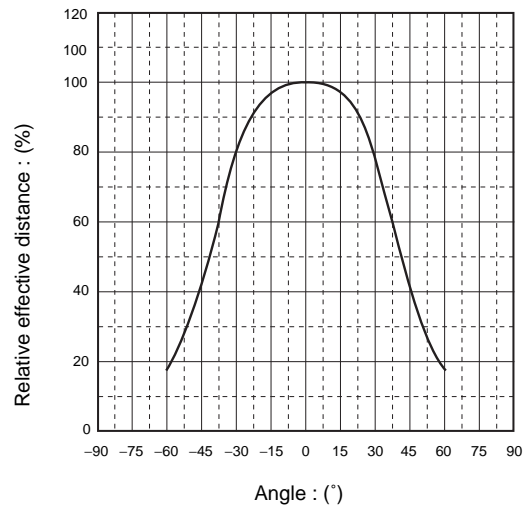

Fig.7 Direction characteristic (Horizontal direction)

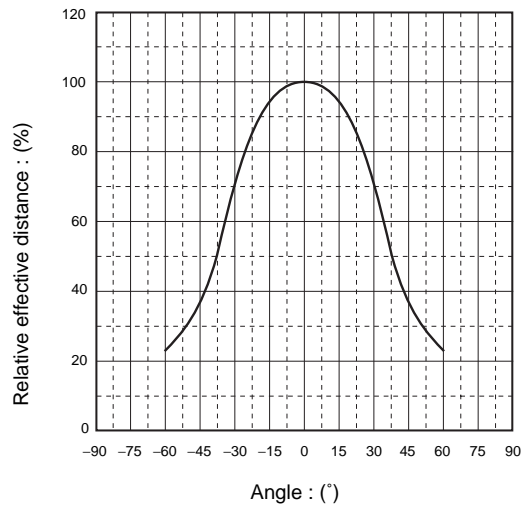
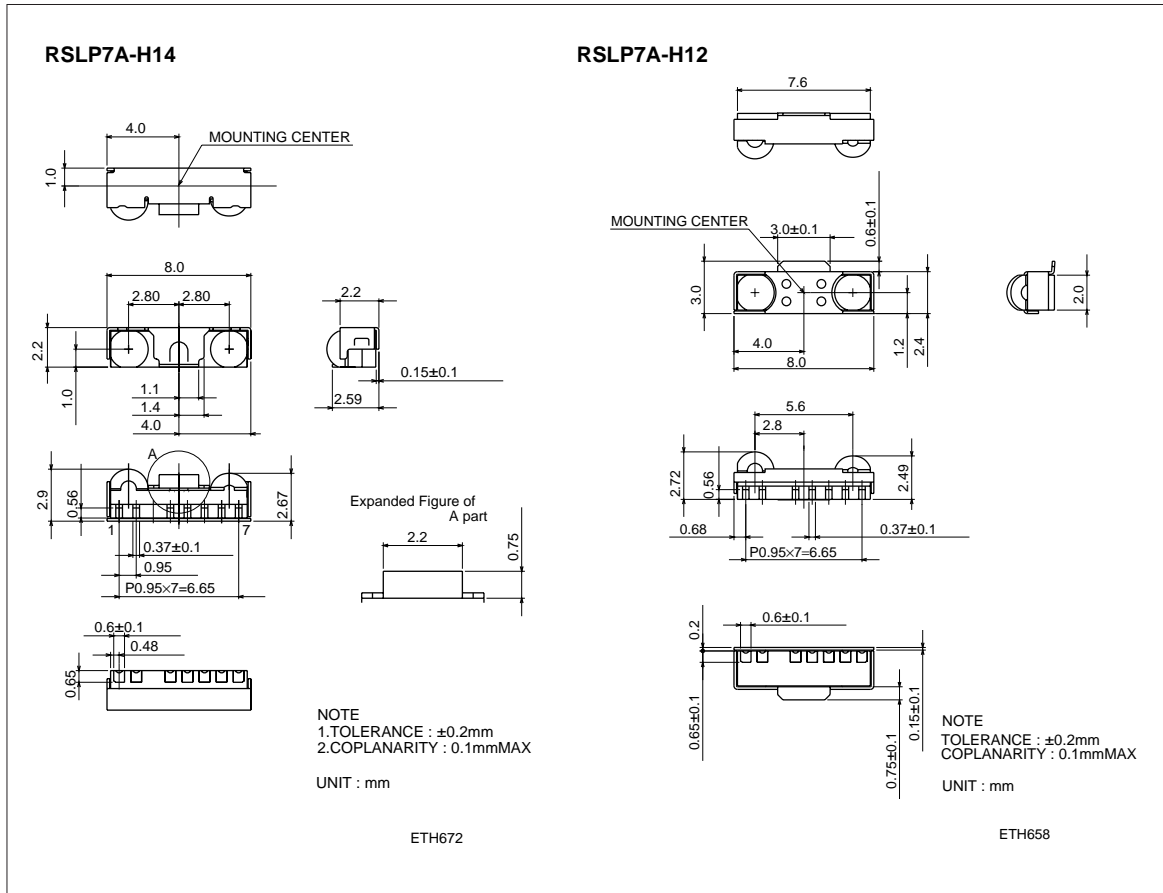

Fig.8 Direction characteristic (Vertical direction)

Photo Link Module

●External dimensions (Unit : mm)



Notes

- No technical content pages of this document may be reproduced in any form or transmitted by any means without prior permission of ROHM CO.,LTD.
- The contents described herein are subject to change without notice. The specifications for the product described in this document are for reference only. Upon actual use, therefore, please request that specifications to be separately delivered.
- Application circuit diagrams and circuit constants contained herein are shown as examples of standard use and operation. Please pay careful attention to the peripheral conditions when designing circuits and deciding upon circuit constants in the set.
- Any data, including, but not limited to application circuit diagrams information, described herein are intended only as illustrations of such devices and not as the specifications for such devices. ROHM CO.,LTD. disclaims any warranty that any use of such devices shall be free from infringement of any third party's intellectual property rights or other proprietary rights, and further, assumes no liability of whatsoever nature in the event of any such infringement, or arising from or connected with or related to the use of such devices.
- Upon the sale of any such devices, other than for buyer's right to use such devices itself, resell or otherwise dispose of the same, no express or implied right or license to practice or commercially exploit any intellectual property rights or other proprietary rights owned or controlled by
- ROHM CO., LTD. is granted to any such buyer.
- Products listed in this document are no antiradiation design.

The products listed in this document are designed to be used with ordinary electronic equipment or devices (such as audio visual equipment, office-automation equipment, communications devices, electrical appliances and electronic toys).

Should you intend to use these products with equipment or devices which require an extremely high level of reliability and the malfunction of which would directly endanger human life (such as medical instruments, transportation equipment, aerospace machinery, nuclear-reactor controllers, fuel controllers and other safety devices), please be sure to consult with our sales representative in advance.

About Export Control Order in Japan

Products described herein are the objects of controlled goods in Annex 1 (Item 16) of Export Trade Control Order in Japan.

In case of export from Japan, please confirm if it applies to "objective" criteria or an "informed" (by MITI clause) on the basis of "catch all controls for Non-Proliferation of Weapons of Mass Destruction.



Компания «ЭлектроПласт» предлагает заключение долгосрочных отношений при поставках импортных электронных компонентов на взаимовыгодных условиях!

Наши преимущества:

- Оперативные поставки широкого спектра электронных компонентов отечественного и импортного производства напрямую от производителей и с крупнейших мировых складов;
- Поставка более 17-ти миллионов наименований электронных компонентов;
- Поставка сложных, дефицитных, либо снятых с производства позиций;
- Оперативные сроки поставки под заказ (от 5 рабочих дней);
- Экспресс доставка в любую точку России;
- Техническая поддержка проекта, помощь в подборе аналогов, поставка прототипов;
- Система менеджмента качества сертифицирована по Международному стандарту ISO 9001;
- Лицензия ФСБ на осуществление работ с использованием сведений, составляющих государственную тайну;
- Поставка специализированных компонентов (Xilinx, Altera, Analog Devices, Intersil, Interpoint, Microsemi, Aeroflex, Peregrine, Syfer, Eurofarad, Texas Instrument, Miteq, Cobham, E2V, MA-COM, Hittite, Mini-Circuits, General Dynamics и др.);

Помимо этого, одним из направлений компании «ЭлектроПласт» является направление «Источники питания». Мы предлагаем Вам помощь Конструкторского отдела:

- Подбор оптимального решения, техническое обоснование при выборе компонента;
- Подбор аналогов;
- Консультации по применению компонента;
- Поставка образцов и прототипов;
- Техническая поддержка проекта;
- Защита от снятия компонента с производства.



Как с нами связаться

Телефон: 8 (812) 309 58 32 (многоканальный)

Факс: 8 (812) 320-02-42

Электронная почта: org@eplast1.ru

Адрес: 198099, г. Санкт-Петербург, ул. Калинина, дом 2, корпус 4, литера А.