



SPECIFICATION FOR APPROVAL

Customer _____

Description DC FAN

Part No. _____ REV. _____

Delta Model No. FFB0412UHN-SP4Z REV. 00

Sample Issue No. _____

Sample Issue Date OCT.15.2012

PLEASE SEND ONE COPY OF THIS SPECIFICATION BACK AFTER YOU SIGNED APPROVAL FOR PRODUCTION PRE-ARRANGMENT.

APPROVED BY: _____

DATE : _____

DELTA ELECTRONICS, INC.
TAOYUAN PLANT
252, SHANG YING ROAD, KUEI SAN INDUSTRIAL ZONE TAOYUAN
SHIEN, TAIWAN, R.O.C.
TEL:886-(0)3-3591968
FAX:886-(0)3-3591991

DELTA ELECTRONICS, INC.
252, SHANG YING ROAD, KUEI SAN
TAOYUAN HSIEN 333, TAIWAN, R. O. C.

TEL : 886-(0)3-3591968
FAX : 886-(0)3-3591991

STATEMENT OF DEVIATION

<input checked="" type="checkbox"/> NONE
<input type="checkbox"/> DESCRIPTION :

DELTA ELECTRONICS, INC.
 252, SHANG YING ROAD, KUEI SAN
 TAOYUAN HSIEN 333, TAIWAN, R. O. C.

TEL : 886-(0)3-3591968
 FAX : 886-(0)3-3591991

SPECIFICATION FOR APPROVAL

Customer:

 Description: DC FAN

Customer P/N: REV:

Delta Model NO.: FFB0412UHN-SP4Z Delta Safety Model NO.: FFB0412UHN-BC2E

Sample Rev: 00 Issue NO:

Sample Issue Date: OCT.15.2012 Quantity:

1. SCOPE:

THIS SPECIFICATION DEFINES THE ELECTRICAL AND MECHANICAL CHARACTERISTICS OF THE DC BRUSHLESS AXIAL FLOW FAN. THE FAN MOTOR IS WITH SINGLE PHASE AND FOUR POLES.

2. CHARACTERS:

ITEM	DESCRIPTION
RATED VOLTAGE	12 VDC
OPERATION VOLTAGE	7.0 - 13.2 VDC
INPUT CURRENT	0.84 (MAX. 1.01) A (SAFETY CURRENT ON LABEL 1.01 A)
INPUT POWER	10.08 (MAX. 12.12) W
SPEED	23000 ± 8% R.P.M.
MAX. AIR FLOW (AT ZERO STATIC PRESSURE)	0.751 (MIN. 0.676) M ³ /MIN. 26.55 (MIN. 23.895) CFM
MAX. AIR PRESSURE (AT ZERO AIRFLOW)	80 (MIN. 64.8) mmH ₂ O 3.15 (MIN. 2.55) inchH ₂ O
ACOUSTICAL NOISE (AVG.)	59.9 (MAX. 63.9) dB-A
INSULATION TYPE	CLASS A

(continued)

PART NO:

DELTA MODEL: FFB0412UHN-SP4Z

INSULATION STRENGTH	10 MEG OHM MIN. AT 500 VDC (BETWEEN FRAME AND (+) TERMINAL)
DIELECTRIC STRENGTH	5 mA MAX. AT 500 VAC 50/60 Hz ONE MINUTE, (BETWEEN FRAME AND (+) TERMINAL)
EXTERNAL COVER	OPEN TYPE
LIFE EXPECTANCE AT LABEL VOLTAGE	70,000 HOURS CONTINUOUS OPERATION AT 40 °C WITH 15 ~ 65 %RH.
ROTATION	CLOCKWISE VIEW FROM NAME PLATE SIDE
OVER CURRENT SHUT DOWN	THE CURRENT WILL SHUT DOWN WHEN LOCKING ROTOR.
LEAD WIRE	UL 1061 -F- AWG #28 BLACK WIRE NEGATIVE(-) RED WIRE POSITIVE(+) BLUE WIRE FREQUENCY(-F00) YELLOW WIRE CONTROL(-PWM)

- NOTES: 1. ALL READINGS ARE MEASURED AFTER STABLY WARMING UP THROUGH 10 MINUTES.
2. THE VALUES WRITTEN IN PARENS , (), ARE LIMITED SPEC.
3. ACOUSTICAL NOISE MEASURING CONDITION:

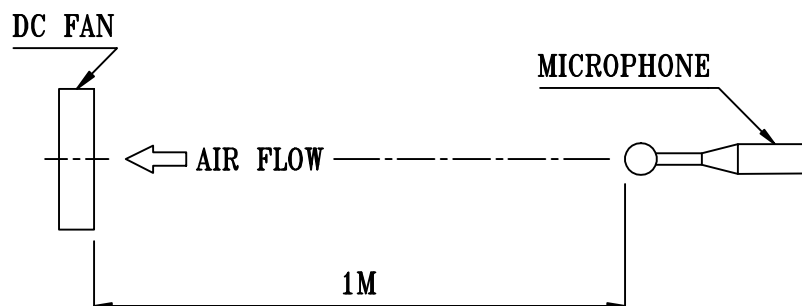

NOISE IS MEASURED AT RATED VOLTAGE IN FREE AIR IN ANECHOIC CHAMBER WITH B & K SOUND LEVEL METER WITH MICROPHONE AT A DISTANCE OF ONE METER FROM THE FAN INTAKE.

PART NO:

DELTA MODEL: FFB0412UHN-SP4Z

3. MECHANICAL:

- 3-1. DIMENSIONS ----- SEE DIMENSIONS DRAWING
- 3-2. FRAME ----- PLASTIC UL: 94V-0
- 3-3. IMPELLER ----- PLASTIC UL: 94V-0
- 3-4. BEARING SYSTEM ----- TWO BALL BEARINGS
- 3-5. WEIGHT ----- 52 GRAMS

4. ENVIRONMENTAL:

- 4-1. OPERATING TEMPERATURE ----- -10 TO +70 DEGREE C
- 4-2. STORAGE TEMPERATURE ----- -40 TO +80 DEGREE C
- 4-3. OPERATING HUMIDITY ----- 5 TO 90 % RH
- 4-4. STORAGE HUMIDITY ----- 5 TO 95 % RH

5. PROTECTION:

5-1. LOCKED ROTOR PROTECTION

IMPEDANCE OF MOTOR WINDING PROTECTS MOTOR FROM FIRE IN 96 HOURS OF LOCKED ROTOR CONDITION AT THE RATED VOLTAGE.

5-2. POLARITY PROTECTION

BE CAPABLE OF WITHSTANDING IF REVERSE CONNECTION FOR POSITIVE AND NEGATIVE LEADS.

6. RE OZONE DEPLETING SUBSTANCES:

- 6-1. NO CONTAINING PBBs, PBBOs, CFCs, PBBEs, PBDPEs AND HCFCs.

7. PRODUCTION LOCATION

- 7-1. PRODUCTS WILL BE PRODUCED IN CHINA OR THAILAND OR TAIWAN.

 PART NO: -----

 DELTA MODEL: FFB0412UHN-SP4Z -----

8.P & Q CURVE:

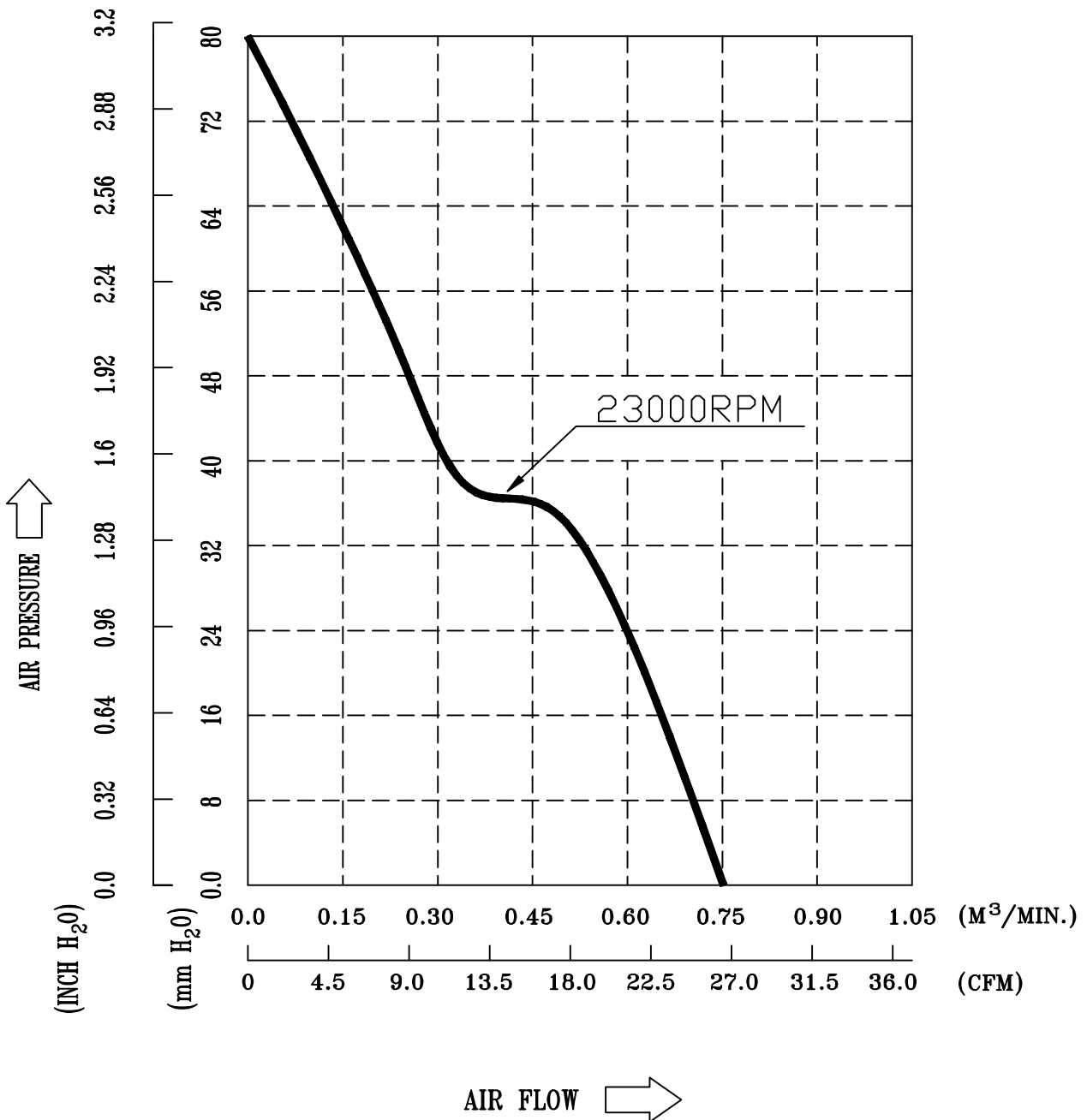

* TEST CONDITION: INPUT VOLTAGE ----- OPERATION VOLTAGE
 TEMPERATURE ----- ROOM TEMPERATURE
 HUMIDITY ----- 65%RH

PART NO:

DELTA MODEL: FFB0412UHN-SP4Z

9. DIMENSION DRAWING:

LABEL:

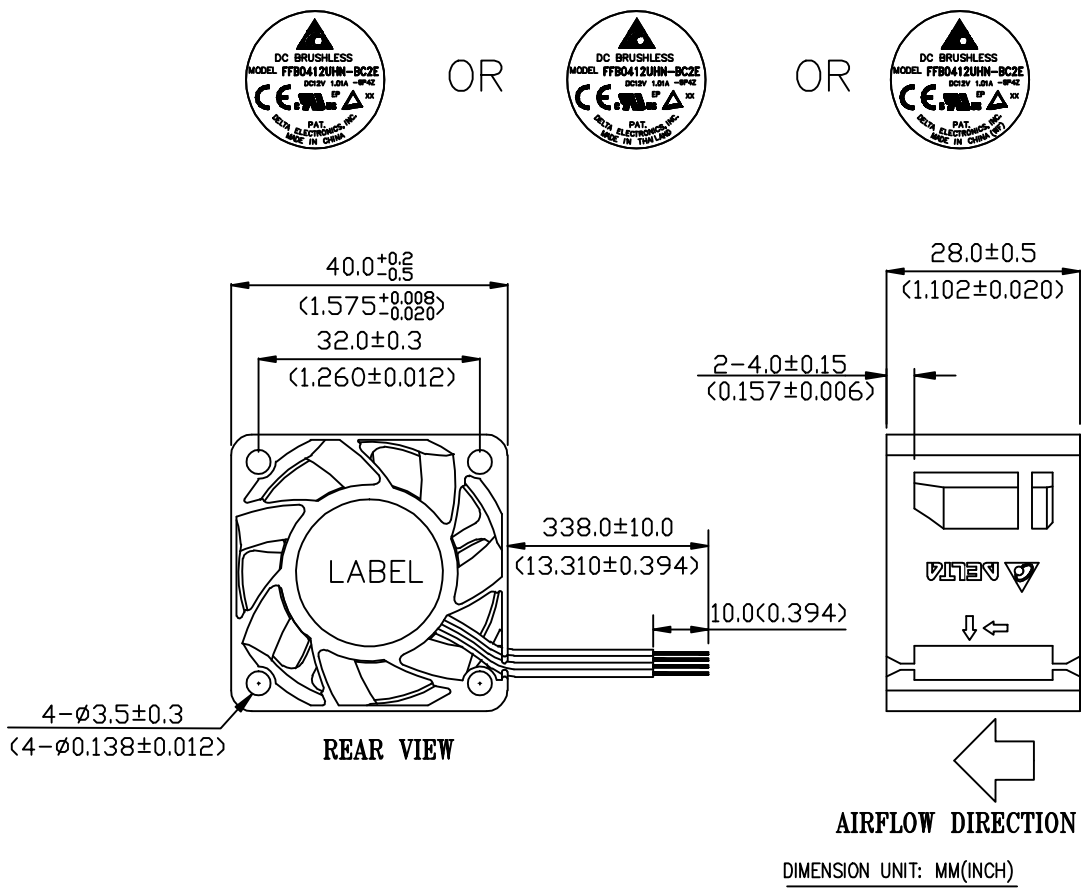

NOTES:

- 1.LEAD WIRE: UL 1061 -F- AWG #28
 - BLACK WIRE -----(-)
 - RED WIRE -----(+)
 - BLUE WIRE -----(FOO)
 - YELLOW WIRE -----(PWM)
- 2.THIS PRODUCT IS RoHS COMPLIANT .

PART NO:

DELTA MODEL: FFB0412UHN-SP4Z

10. FREQUENCY GENERATOR (FG) SIGNAL:

1. OUTPUT CIRCUIT - OPEN COLLECTOR MODE:

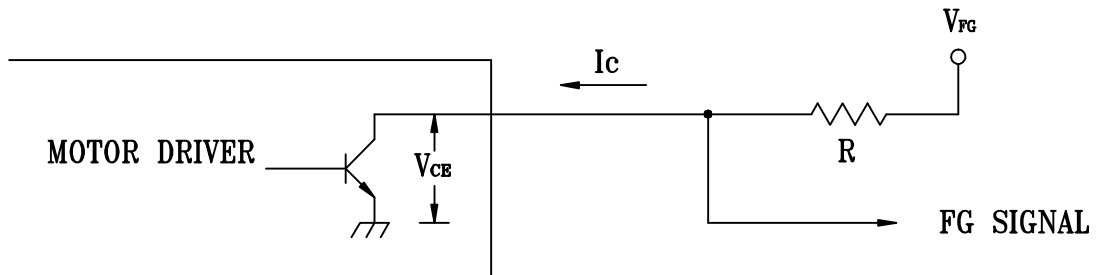

CAUTION:

THE LEAD WIRE OF FG SIGNAL CAN NOT TOUCH
THE LEAD WIRE OF POSITIVE OR NEGATIVE.

2. SPECIFICATION:

$V_{FG} = 13.2V \text{ MAX.}$ $I_c = 5mA \text{ MAX.}$

$V_{CE} = 0.5V \text{ MAX.}$ $R \geq V_{FG} / I_c$

3. FREQUENCY GENERATOR WAVEFORM:

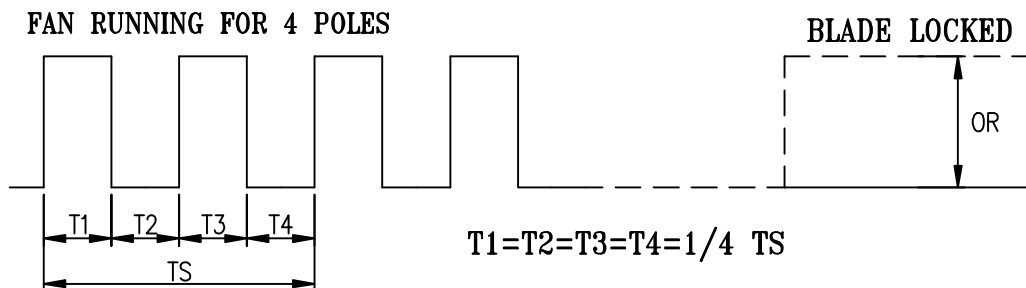
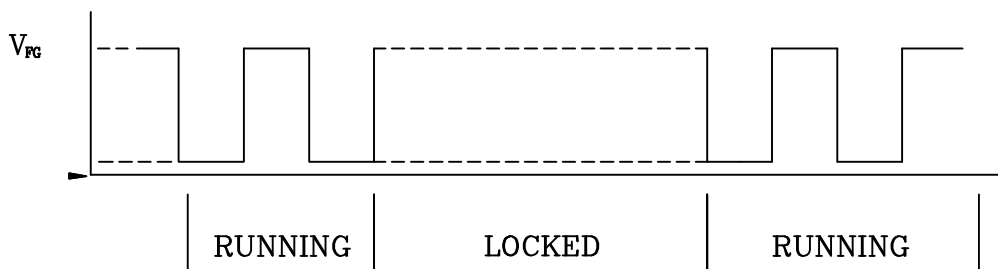

$N = \text{R.P.M}$

$T_S = 60 / N (\text{SEC})$

*VOLTAGE LEVEL AFTER BLADE LOCKED

*4 POLES

PART NO:

DELTA MODEL: FFB0412UHN-SP4Z

11. PWM CONTROL SIGNAL:

SIGNAL VOLTAGE RANGE: 0~15VDC

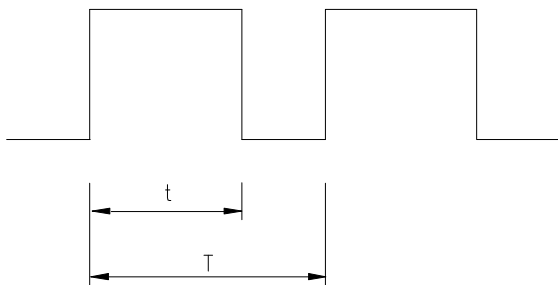

HIGH SIGNAL: 15 VDC MAX.
2.8 VDC MIN.

LOW SIGNAL: 0.8 VDC MAX.
0 VDC MIN.

$$\text{DUTY CYCLE} = \frac{t}{T} * 100(\%)$$

- THE PREFERRED OPERATING POINT FOR THE FAN IS 25K HZ.
- AT 100% DUTY CYCLE, THE ROTOR WILL SPIN AT MAXIMUM SPEED.
- AT 0% DUTY CYCLE, THE ROTOR WILL STOP.
- WITH CONTROL SIGNAL LEAD DISCONNECTED, THE FAN WILL SPIN AT MAXIMUM SPEED.
- AT 25K HZ, RATED VOLTAGE, 30% DUTY CYCLE, THE FAN WILL BE ABLE TO START FROM A DEAD STOP.

12. SPEED VS PWM CONTROL SIGNAL: (AT RATED VOLTAGE & PWM FREQUENCY=25K HZ)

DUTY CYCLE (%)	SPEED R.P.M. (REF.)	CURRENT (A) TYP. (REF.)
100	23000 ± 8%	0.84
50	12000 ± 8%	0.18
0	0	0.02

13. PWM CONTROL LEAD WIRE INPUT IMPEDANCE:

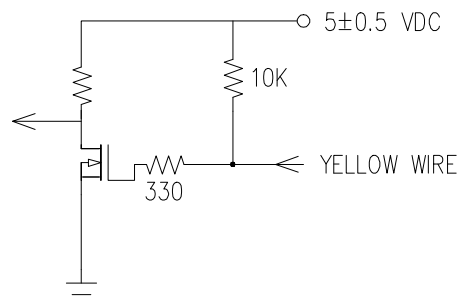

13-1. THE FAN SPEED WILL DEFAULT TO MAXIMUM WHEN THE SPEED CONTROL INPUT IS LEFT UNCONNECTED.

Application Notice

- 1. Delta will not guarantee the performance of the products if the application condition falls outside the parameters set forth in the specification.**
- 2. A written request should be submitted to Delta prior to approval if deviation from this specification is required.**
- 3. Please exercise caution when handling fans. Damage may be caused when pressure is applied to the impeller, if the fans are handled by the lead wires, or if the fan was hard-dropped to the production floor.**
- 4. Except as pertains to some special designs, there is no guarantee that the products will be free from any such safety problems or failures as caused by the introduction of powder, droplets of water or encroachment of insect into the hub.**
- 5. The above-mentioned conditions are representative of some unique examples and viewed as the first point of reference prior to all other information.**
- 6. It is very important to establish the correct polarity before connecting the fan to the power source. Positive (+) and Negative (-). Damage may be caused to the fans if connection is with reverse polarity, if there is no foolproof method to protect against such error specifically mentioned in this spec.**
- 7. Delta fans without special protection are not suitable where any corrosive fluids are introduced to their environment.**
- 8. Please ensure all fans are stored according to the storage temperature limits specified. Do not store fans in a high humidity environment. We highly recommend performance testing is conducted before shipping, if the fans have been stored over 6 months.**
- 9. Not all fans are provided with the Lock Rotor Protection feature. If you impair the rotation of the impeller for the fans that do not have this function, the performance of those fans will lead to failure.**
- 10. Please be cautious when mounting the fan. Incorrect mounting of fans may cause excess resonance, vibration and subsequent noise.**
- 11. It is important to consider safety when testing the fans. A suitable fan guard should be fitted to the fan to guard against any potential for personal injury.**
- 12. Except where specifically stated, all tests are carried out at room (ambient) temperature and relative humidity conditions of 25°C, 65% RH. The test value is only for fan performance itself.**
- 13. Be certain to connect an “ 4.7 μ F or greater” capacitor to the fan externally when the application calls for using multiple fans in parallel, to avoid any unstable power.**



Компания «ЭлектроПласт» предлагает заключение долгосрочных отношений при поставках импортных электронных компонентов на взаимовыгодных условиях!

Наши преимущества:

- Оперативные поставки широкого спектра электронных компонентов отечественного и импортного производства напрямую от производителей и с крупнейших мировых складов;
- Поставка более 17-ти миллионов наименований электронных компонентов;
- Поставка сложных, дефицитных, либо снятых с производства позиций;
- Оперативные сроки поставки под заказ (от 5 рабочих дней);
- Экспресс доставка в любую точку России;
- Техническая поддержка проекта, помощь в подборе аналогов, поставка прототипов;
- Система менеджмента качества сертифицирована по Международному стандарту ISO 9001;
- Лицензия ФСБ на осуществление работ с использованием сведений, составляющих государственную тайну;
- Поставка специализированных компонентов (Xilinx, Altera, Analog Devices, Intersil, Interpoint, Microsemi, Aeroflex, Peregrine, Syfer, Eurofarad, Texas Instrument, Miteq, Cobham, E2V, MA-COM, Hittite, Mini-Circuits, General Dynamics и др.);

Помимо этого, одним из направлений компании «ЭлектроПласт» является направление «Источники питания». Мы предлагаем Вам помощь Конструкторского отдела:

- Подбор оптимального решения, техническое обоснование при выборе компонента;
- Подбор аналогов;
- Консультации по применению компонента;
- Поставка образцов и прототипов;
- Техническая поддержка проекта;
- Защита от снятия компонента с производства.



Как с нами связаться

Телефон: 8 (812) 309 58 32 (многоканальный)

Факс: 8 (812) 320-02-42

Электронная почта: org@eplast1.ru

Адрес: 198099, г. Санкт-Петербург, ул. Калинина, дом 2, корпус 4, литера А.