

**EVERLIGHT**EVERLIGHT  
EVERLIGHT**DATASHEET**

## Opto Interrupter ITR9909

### Features

- Fast response time
- High analytic
- Cut-off visible wavelength  $\lambda_p=940\text{nm}$
- High sensitivity
- Pb free
- This product itself will remain within RoHS compliant version

### Description

- The ITR9909 consist of an infrared emitting diode and an NPN silicon phototransistor, encased side-by-side on converging optical axis in a black thermoplastic housing,
- The phototransistor receives radiation from the IR only .This is the normal situation.
- But when an object is in between , phototransistor could not receives the radiation.
- For additional component information , please refer to IR and PT

### Applications

- Mouse Copier
- Switch Scanner
- Floppy disk driver
- Non-contact Switching
- For Direct Board

**Device Selection Guide**

Device No.	Chip Materials	Lens Color
IR	GaAlAs	Blue
PT	Silicon	Black

**Absolute Maximum Ratings (Ta=25 °C)**

Parameter		Symbol	Ratings	Unit
Input	Power Dissipation at(or below) 25 °C Free Air Temperature	Pd	75	mW
	Reverse Voltage	V <sub>R</sub>	5	V
	Forward Current	I <sub>F</sub>	50	mA
	Peak Forward Current (*1) Pulse width 100µs, Duty cycle=1%	I <sub>FP</sub>	1	A
Output	Collector Power Dissipation	Pd	75	mW
	Collector Current	I <sub>C</sub>	50	mA
	Collector-Emitter Voltage	B V <sub>CEO</sub>	30	V
	Emitter-Collector Voltage	B V <sub>ECO</sub>	5	V
Operating Temperature		T <sub>opr</sub>	-25~+85	
Storage Temperature		T <sub>stg</sub>	-40~+85	
Lead Soldering Temperature (*2) (1/16 inch form body for 5 seconds)		T <sub>sol</sub>	260	

(\*1)  $t_w=100 \mu\text{sec.}$ ,  $T=10 \text{ msec.}$  (\*2)  $t=5 \text{ Sec}$

**Electro-Optical Characteristics (Ta=25 )**

Parameter		Symbol	Min.	Typ.	Max.	Unit	Conditions
Input	Forward Voltage	VF	---	1.2	1.5	V	IF=20mA
			---	1.4	1.85		IF=100mA, tp=100 μ s, tp/T=0.01
			---	2.6	4.0		IF=1A, tp=100 μ s, tp/T=0.01
	Reverse Current	IR	---	---	10	μA	VR=5V
	Peak Wavelength	λP	---	940	---	nm	IF=20mA
Output	Dark C urrent	ICEO	---	---	100	nA	VCE=20V, Ee=0mW/cm <sup>2</sup>
	C-E Saturation Voltage	VCE(sat)	---	---	0.4	V	IC=2mA Ee=1mW/cm <sup>2</sup>
Transfer Characteristics	Collect Current	IC(ON)	200	---	---	uA	VCE=5V IF=20mA
	Rise time	tr	---	15	---	μsec	VCE=5V, IC=1mA ,RL=1000Ω
	Fall time	tf	---	15	---	μsec	

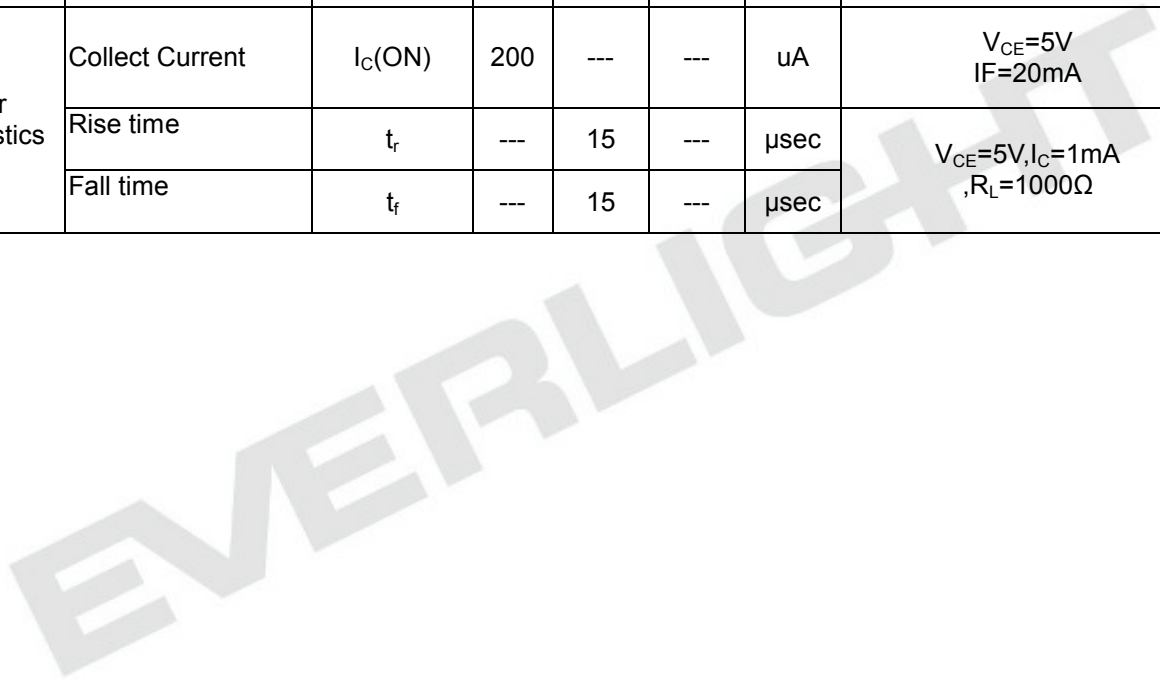

**Typical Electrical/Optical/Characteristics Curves for IR**

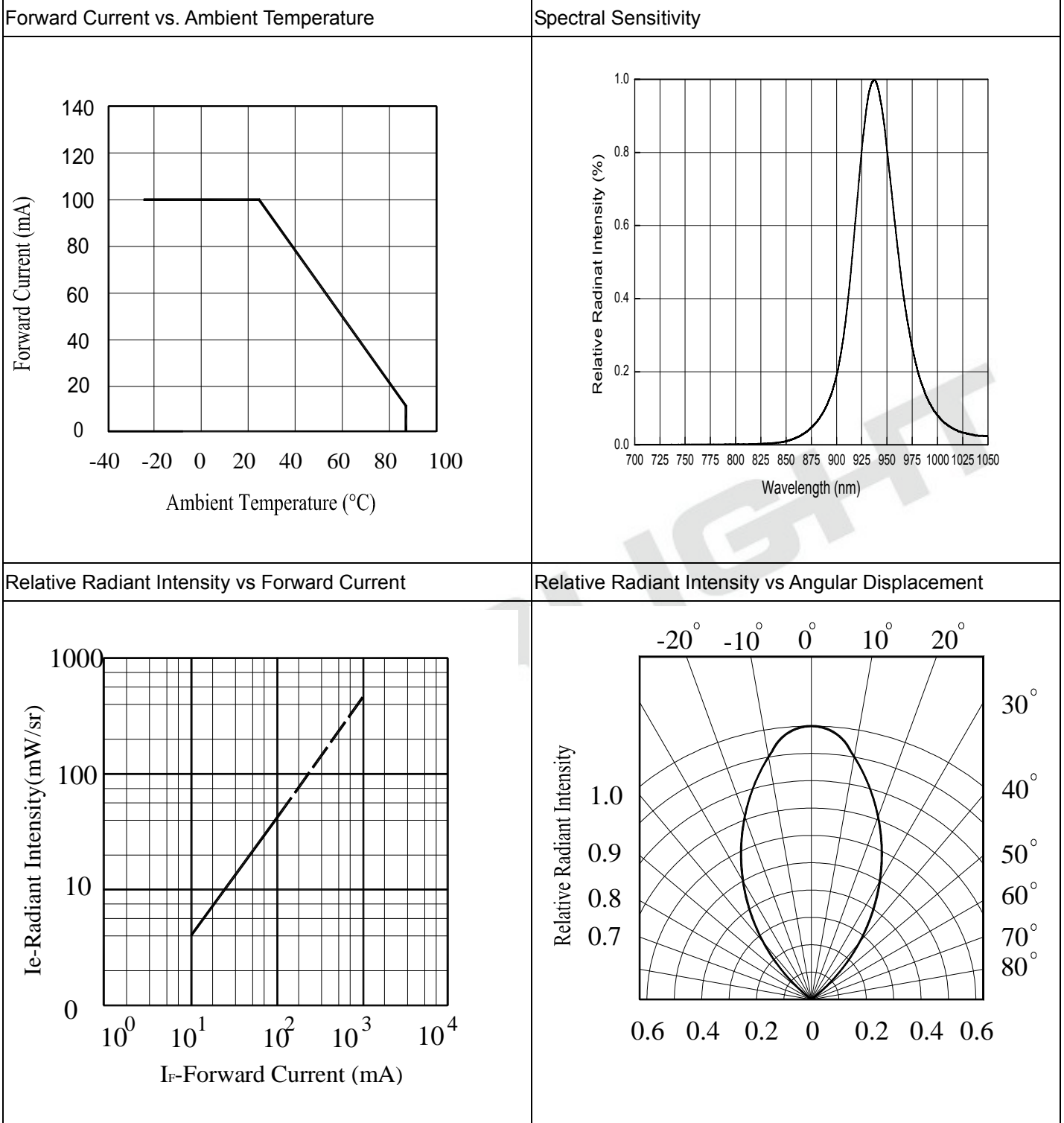

Typical Electrical/Optical/Characteristics Curves for PT

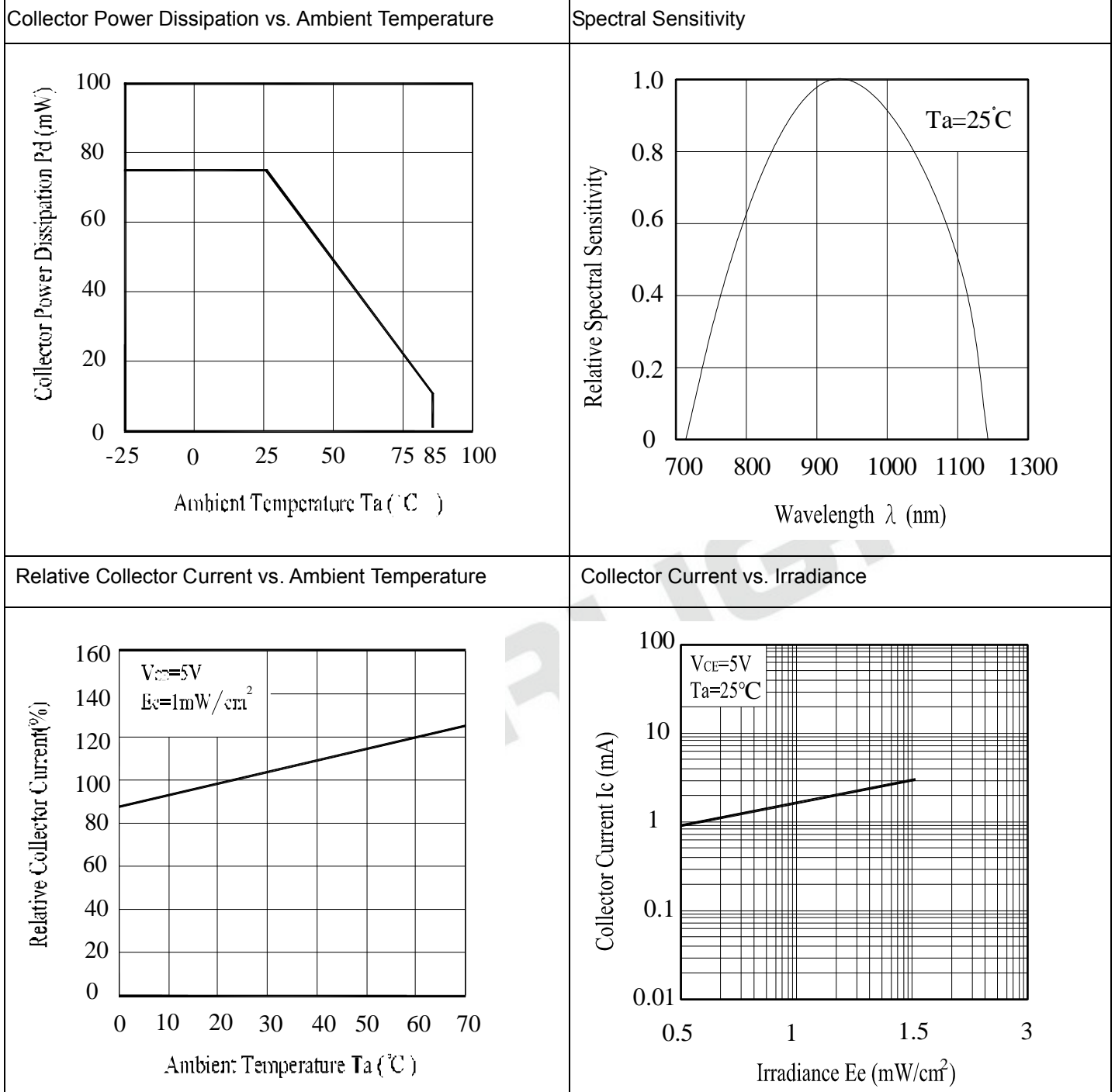

Collector Dark Current vs. Ambient Temperature

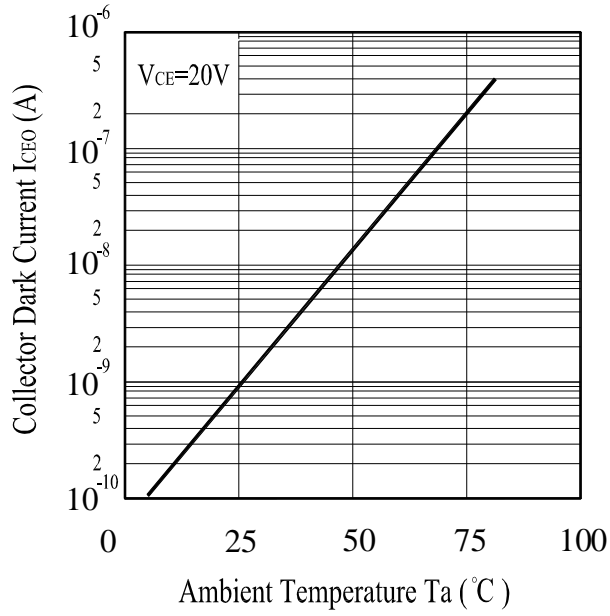

Collector Current vs. Collector-Emitter Voltage

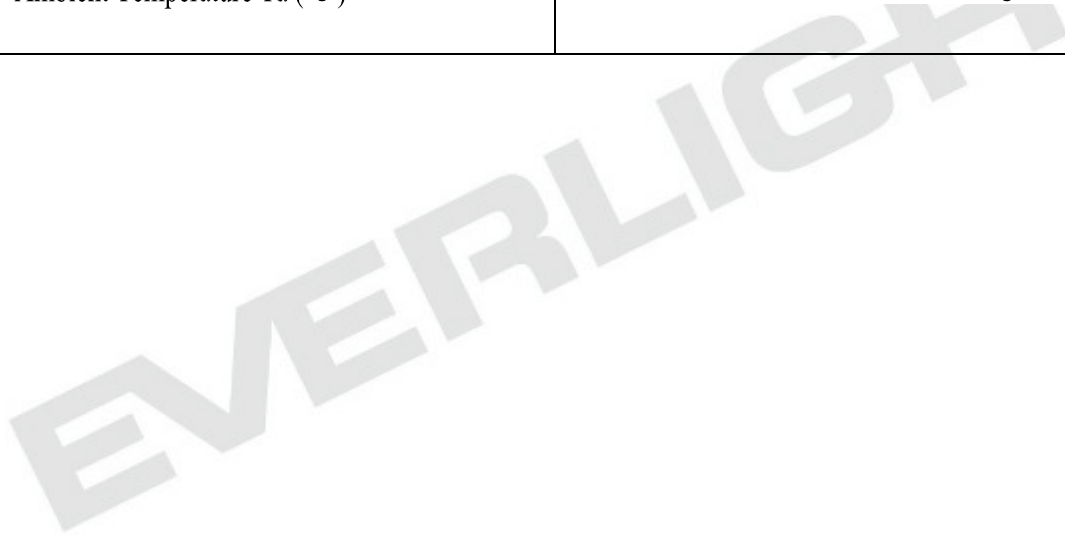
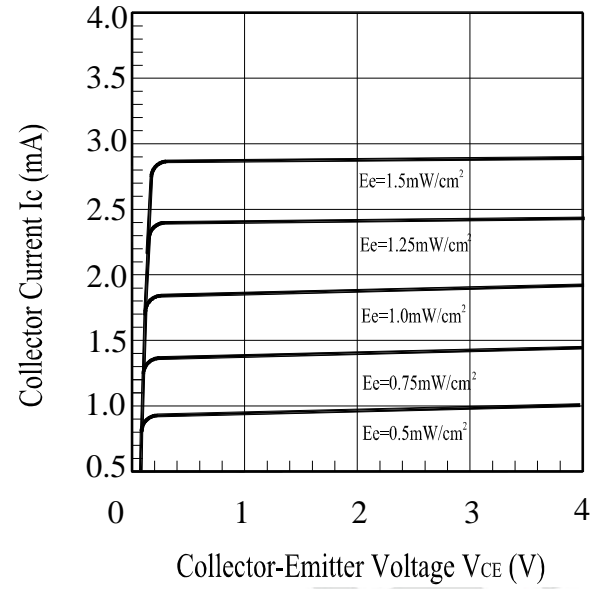

### Typical Electrical/Optical/Characteristics Curves for ITR

Relative Collector Current vs Distance Between Sensor

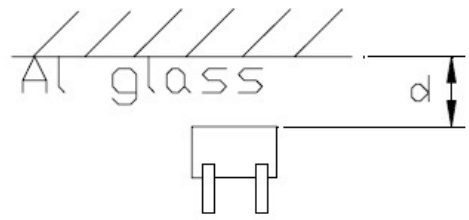
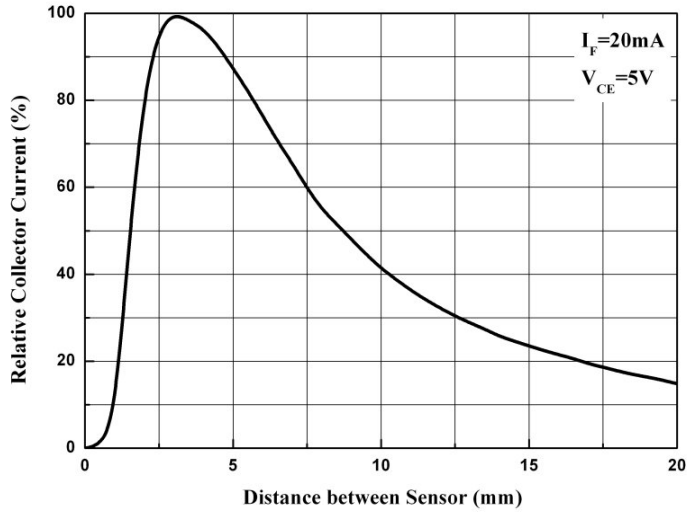

EVERLIGHT

### Package Dimension

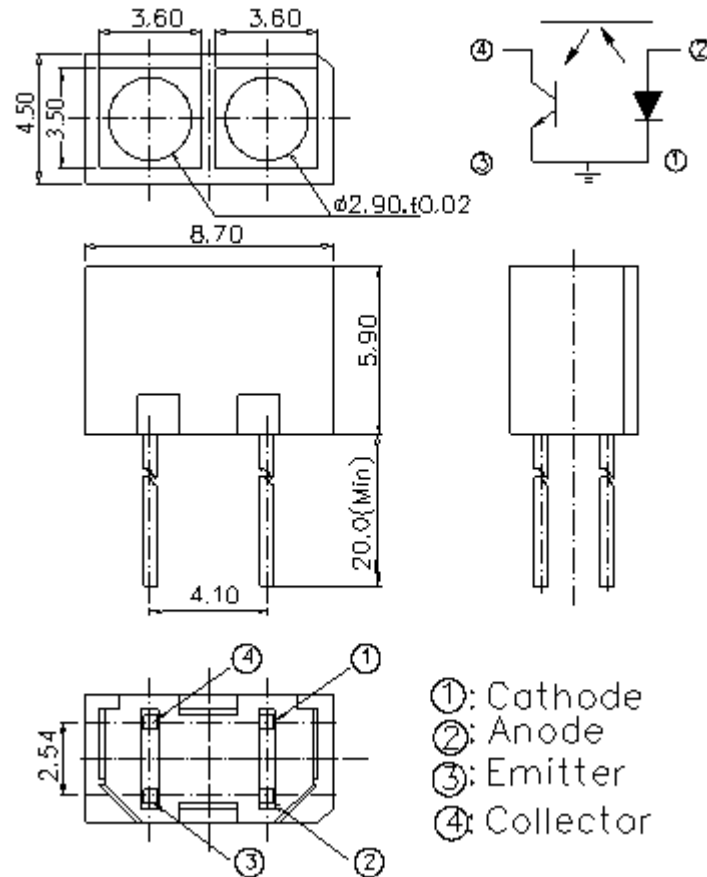

Note: Tolerances unless dimensions  $\pm 0.25$ mm



**Packing Quantity Specification**

- 1.150PCS/1 Bag, 5 Bags/1Box
2. 10Boxes/1Carton

**Label Form Specification**

(Pb)	<b>EVERLIGHT</b>	(X)
CPN: P/N:		
	<b>RoHS</b>	
ITR9909		
QTY:	CAT:	
	HUE:	
LOT NO:	REF:	
		
Reference		
		

- CPN: Customer's Product Number
- P/N: Product Number
- QTY: Packing Quantity
- CAT: Luminous Intensity Rank
- HUE: Dom. Wavelength Rank
- REF: Forward Voltage Rank
- LOT No: Lot Number
- X: Month
- Reference: Identify Label Number

**Notes**

1. Above specification may be changed without notice. EVERLIGHT will reserve authority on material change for above specification.
2. When using this product, please observe the absolute maximum ratings and the instruction for using outlined in these specification sheets. EVERLIGHT assumes no responsibility for any damage resulting from use of the product which does not comply with the absolute maximum ratings and the instructions included in these specification sheets.
3. These specification sheets include materials protected under copyright of EVERLIGHT corporation. Please don't reproduce or cause anyone to reproduce them without EVERLIGHT's consent.



Компания «ЭлектроПласт» предлагает заключение долгосрочных отношений при поставках импортных электронных компонентов на взаимовыгодных условиях!

Наши преимущества:

- Оперативные поставки широкого спектра электронных компонентов отечественного и импортного производства напрямую от производителей и с крупнейших мировых складов;
- Поставка более 17-ти миллионов наименований электронных компонентов;
- Поставка сложных, дефицитных, либо снятых с производства позиций;
- Оперативные сроки поставки под заказ (от 5 рабочих дней);
- Экспресс доставка в любую точку России;
- Техническая поддержка проекта, помощь в подборе аналогов, поставка прототипов;
- Система менеджмента качества сертифицирована по Международному стандарту ISO 9001;
- Лицензия ФСБ на осуществление работ с использованием сведений, составляющих государственную тайну;
- Поставка специализированных компонентов (Xilinx, Altera, Analog Devices, Intersil, Interpoint, Microsemi, Aeroflex, Peregrine, Syfer, Eurofarad, Texas Instrument, Miteq, Cobham, E2V, MA-COM, Hittite, Mini-Circuits, General Dynamics и др.);

Помимо этого, одним из направлений компании «ЭлектроПласт» является направление «Источники питания». Мы предлагаем Вам помощь Конструкторского отдела:

- Подбор оптимального решения, техническое обоснование при выборе компонента;
- Подбор аналогов;
- Консультации по применению компонента;
- Поставка образцов и прототипов;
- Техническая поддержка проекта;
- Защита от снятия компонента с производства.



#### Как с нами связаться

**Телефон:** 8 (812) 309 58 32 (многоканальный)

**Факс:** 8 (812) 320-02-42

**Электронная почта:** [org@eplast1.ru](mailto:org@eplast1.ru)

**Адрес:** 198099, г. Санкт-Петербург, ул. Калинина, дом 2, корпус 4, литера А.