

SF2037B-2

76.500 MHz SAW Filter

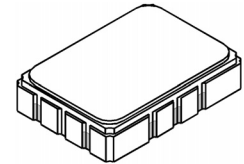

SMP-03

- *Designed for SDARS IF Receiver*
- *Low Insertion Loss*
- *5.0 X 7.0 mm Surface-Mount Case*
- *Differential or Single Ended Input and Output*

Absolute Maximum Ratings

Rating	Value	Units
Maximum Incident Power in Passband	+10	dBm
Max. DC voltage between any 2 terminals	30	VDC
Storage Temperature Range (with tape & reel)	-40 to +85	°C
Storage Temperature Range (without tape & reel)	-50 to +125	°C
Max Soldering Profile	265°C for 10 s	

Electrical Characteristics

Characteristic	Sym	Notes	Min	Typ	Max	Units		
Nominal Center Frequency	f_c	1	76.500			MHz		
Passband	Insertion Loss	IL	3.8	10.0	12.5	dB		
				1dB Passband	BW ₁	4.1		MHz
				15dB Bandwidth	BW ₁₅	6.7	6.8	MHz
				30dB Bandwidth	BW ₃₀	7.7	7.8	MHz
Amplitude Ripple over $f_c \pm 1.9$ MHz				0.5	1.10	dB _{P-P}		
Group Delay Variation over $f_c \pm 1.9$ MHz		GDV		65	150	ns _{P-P}		
Rejection	50 to 70.44 MHz	1, 3	37	43		dB		
			70.44 to 72.04 MHz	34	43			
			81.26 to 82.56 MHz	38	49			
			82.56 to 86.50 MHz	39	48			
			86.5 to 91.50 MHz	41	48			
			91.50 to 100.000 MHz	45	58			
Operating Temperature Range	T _A	1	-40		+105	°C		
Frequency Temperature Coefficient	FTC			-18		ppm/°C		
Differential Input	175 ohms							
Differential Output	1000 ohms							
Case Style	SMP-03 7 x 5 mm Nominal Footprint							
Lid Symbolization (YY=year, WW=week, S=shift) See note 4	RFM SF2037B-2 YYWWS							

Electrical Connections

Connection	Terminals
Port 1 Hot	10
Port 1 Ground Return	1
Port 2 Hot	5
Port 2 Ground Return	6
Case Ground	All Others



CAUTION: Electrostatic Sensitive Device. Observe precautions for handling.

NOTES:

1. Unless noted otherwise, all specifications apply over the operating temperature range with filter soldered to the specified demonstration board with impedance matching to 50 Ω and measured with 50 Ω network analyzer.
2. Unless noted otherwise, all frequency specifications are referenced to the nominal center frequency, f_c .
3. Rejection is measured as attenuation below the minimum IL point in the passband. Rejection in final user application is dependent on PCB layout and external impedance matching design. See Application Note No. 42 for details.
4. "LRIP" or "L" after the part number indicates "low rate initial production" and "ENG" or "E" indicates "engineering prototypes."
5. The design, manufacturing process, and specifications of this filter are subject to change.
6. Tape and Reel Standard ANSI / EIA 481.
7. Either Port 1 or Port 2 may be used for either input or output in the design. However, impedances and impedance matching may vary between Port 1 and Port 2, so that the filter must always be installed in one direction per the circuit design.
8. US and international patents may apply.
9. Murata, stylized Murata logo, and Murata N.A., Inc. are registered trademarks of Murata Manufacturing Co., Ltd.

Matching Circuit and Matching Component Values Used in G3 Sirius Radios

(Refer to Sirius Radio G3 Chipset Application Note, Doc. #RX000104-B, Sec. 4.2.4)

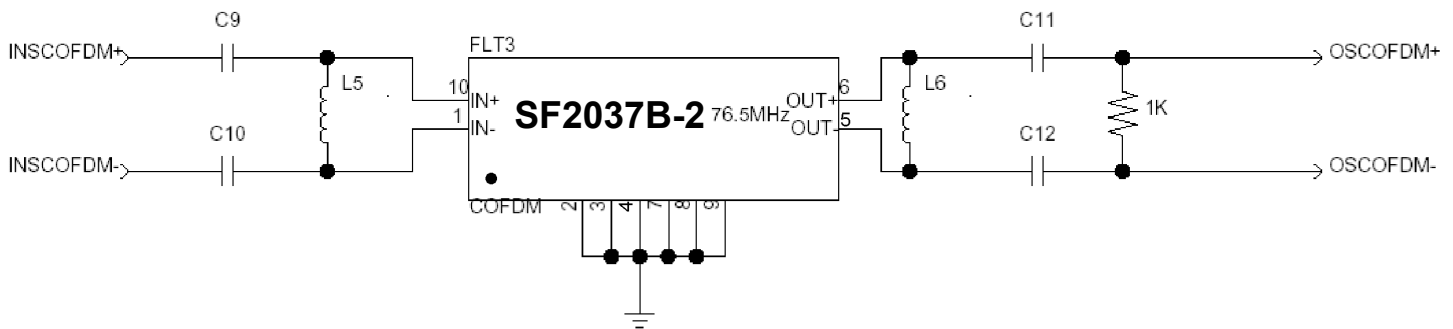

COFDM Narrowband SAW Matching Circuit

COFDM Narrowband SAW Matching Values

Reference Designator	Value
C9	10 pF
C10	10 pF
L5	270 nH
L6	390 nH
C11	100 pF
C12	100 pF

Matching Circuit and Matching Component Values Used on Filter Demo Board

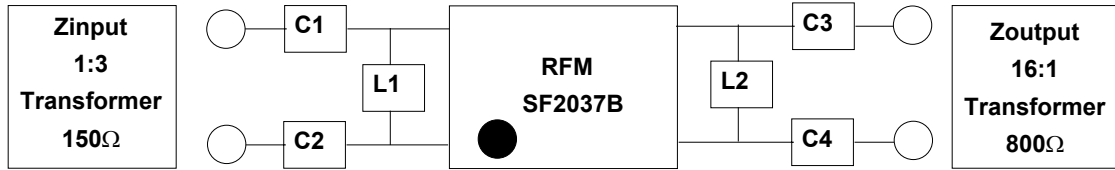

SF2037B
76.500 MHz

C1 = 9pF
C2 = 9pF
L1 = 270nH
L2 = 330nH
C3 = 18pF
C4 = 18pF

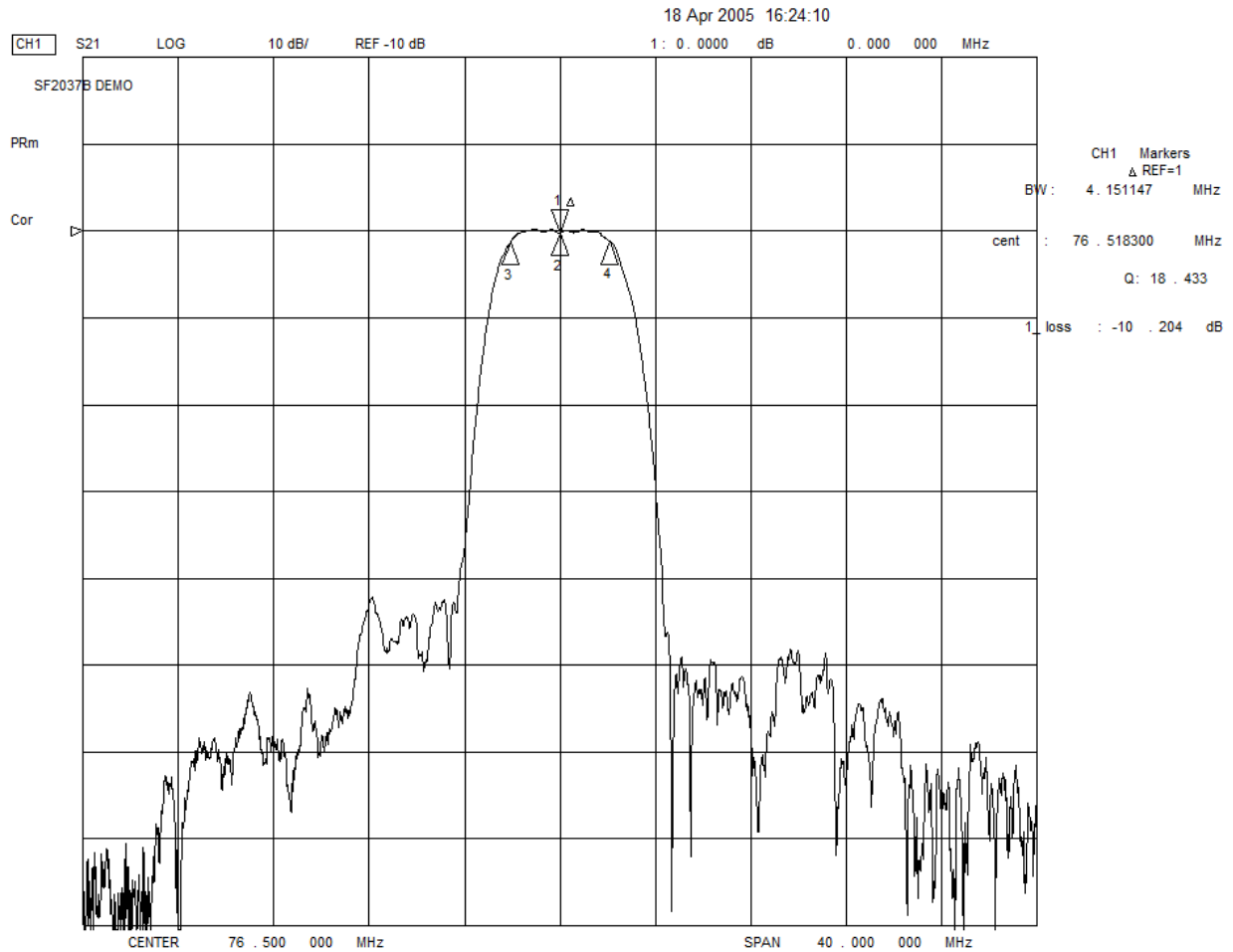

18 Apr 2005 16:18:31

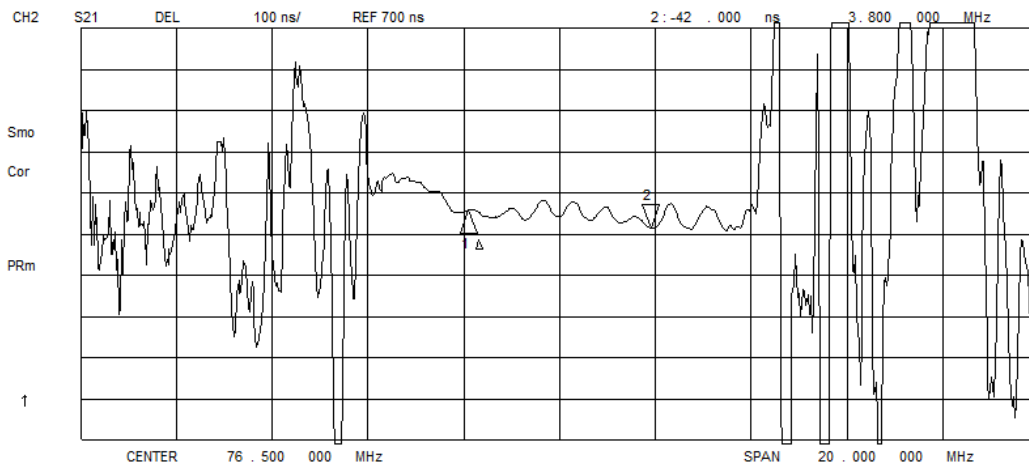
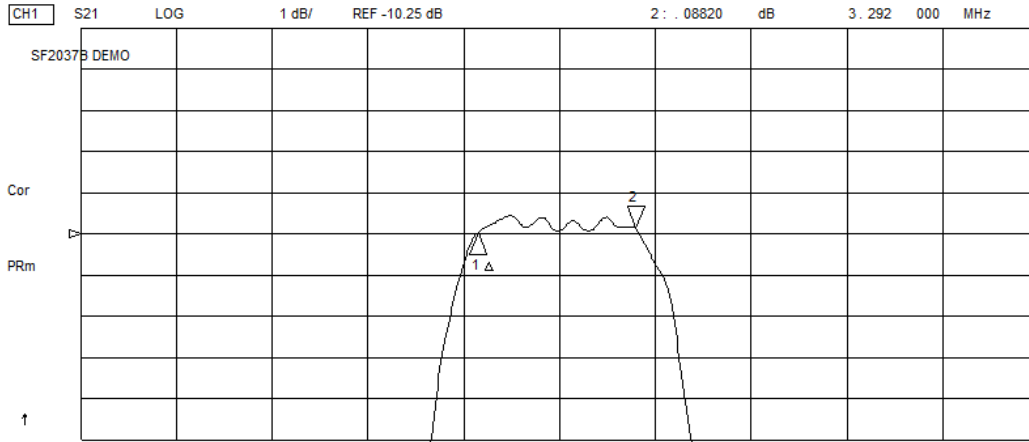

18 Apr 2005 16:28:43

CH1 S11 1 UFS

1: 59.928 Ω -9.8086 Ω 212.11 pF 76.500 000 MHz

SF2037B DEMO

Cor

PRm

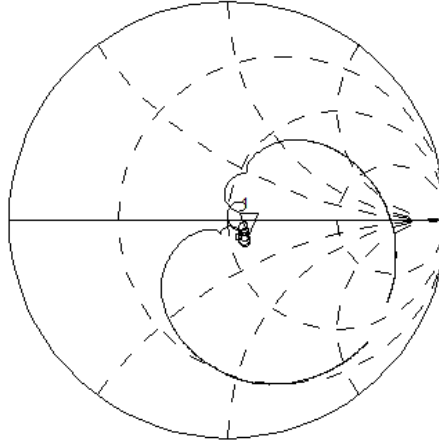

CH2 S22 1 UFS

1: 43.949 Ω 3.1992 Ω 6.6558 nH 76.500 000 MHz

Cor

PRm

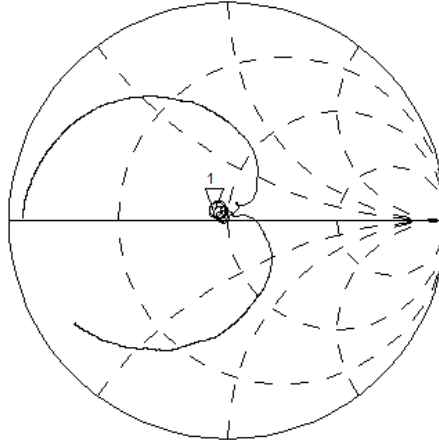

CENTER 76.500 000 MHz

SPAN 40.000 000 MHz

SMP-03 Case

10-Terminal Ceramic Surface-Mount Case

7 x 5 mm Nominal Footprint

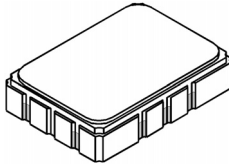

Recommended PCB Footprint

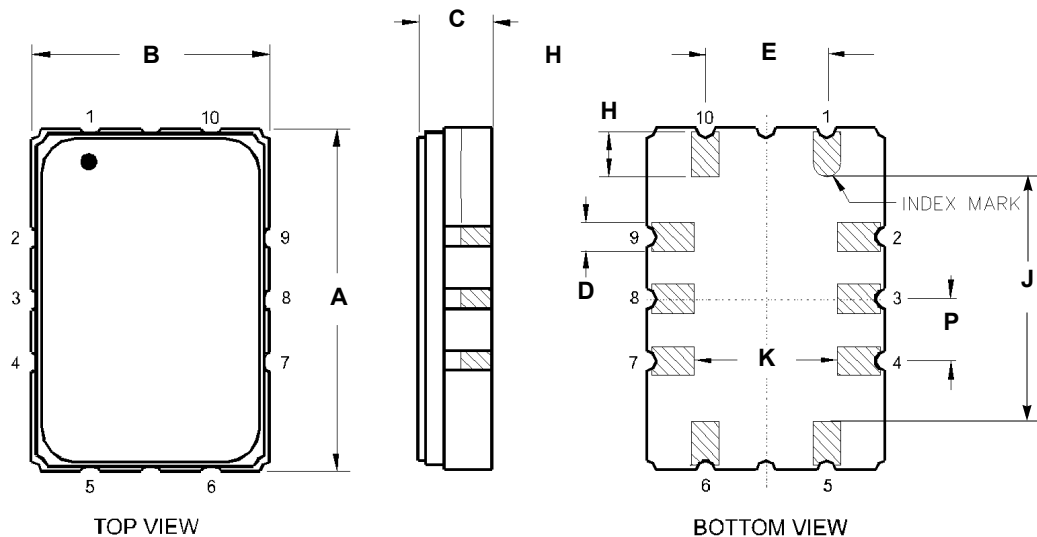
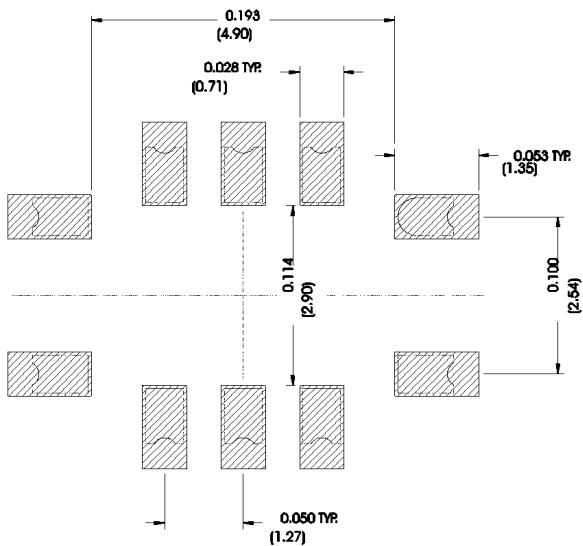

Case Dimensions

Dimension	mm			Inches		
	Min	Nom	Max	Min	Nom	Max
A	6.80	7.00	7.20	0.268	0.276	0.283
B	4.80	5.00	5.20	0.189	0.197	0.205
C		1.65	2.00		0.065	0.079
D	.47	0.60	.73	0.019	0.024	0.029
E	2.41	2.54	2.67	0.095	0.100	0.105
H	0.87	1.0	1.13	0.034	0.039	0.044
J	4.87	5.00	5.13	0.192	0.197	0.202
K	2.87	3.00	3.13	0.113	0.118	0.123
P	1.14	1.27	1.40	0.045	0.050	0.055

Materials

Solder Pad Termination	Au plating 30 - 60 ulnches (76.2-152 uM) over 80-200 ulnches (203-508 uM) Ni.
Lid	Fe-Ni-Co Alloy Electroless Nickel Plate (8-11% Phosphorus) 100-200 ulnches Thick
Body	Al ₂ O ₃ Ceramic
Pb Free	

Electrical Connections

Connection		Terminals
Port 1	Input or Return	10
	Return or Input	1
Port 2	Output or Return	5
	Return or Output	6
Ground		All others
Single Ended Operation		Return is ground
Differential Operation		Return is hot

Tape and Reel Specifications

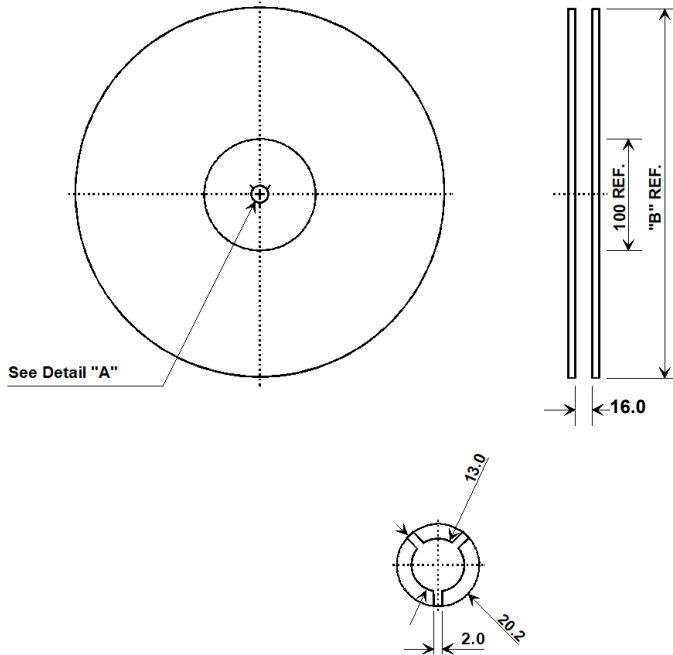

"B" Nominal Size		Quantity Per Reel
Inches	millimeters	
7	178	500
13	330	2000

Product Reflow/ESD/MSL

Reflow Peak Temperature	265	°C
Reflow Peak Time	10	Seconds
Liquidus 217 Temperature/Time	110	Seconds
Over Liquidus 230 Temperature/Time	70	Seconds
Reflow Condition	SMT	
Class Level HBM	2	
HBM(V)	2000	HBM(V)
MM(V)	N/A	MM(V)
CDM(V)	2000	CDM(V)
MSL	1	

COMPONENT ORIENTATION and DIMENSIONS

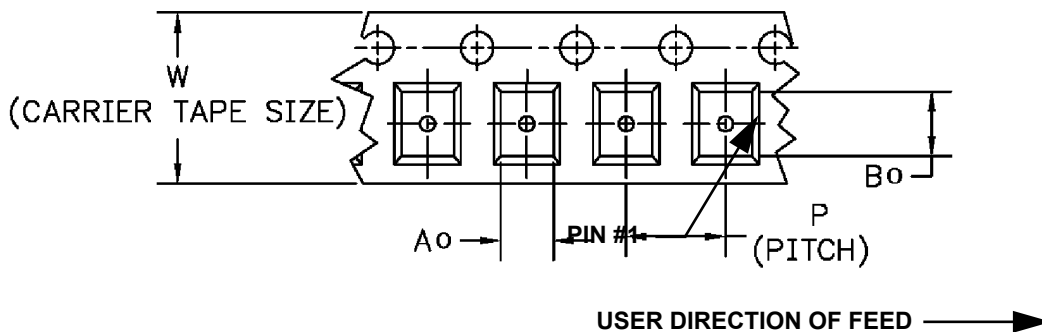
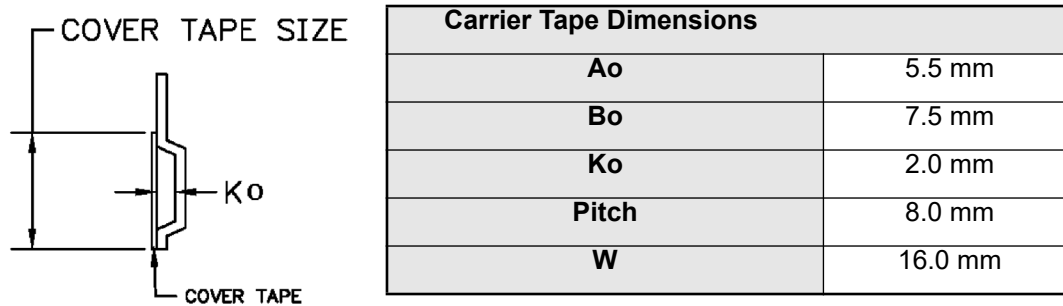



Компания «ЭлектроПласт» предлагает заключение долгосрочных отношений при поставках импортных электронных компонентов на взаимовыгодных условиях!

Наши преимущества:

- Оперативные поставки широкого спектра электронных компонентов отечественного и импортного производства напрямую от производителей и с крупнейших мировых складов;
- Поставка более 17-ти миллионов наименований электронных компонентов;
- Поставка сложных, дефицитных, либо снятых с производства позиций;
- Оперативные сроки поставки под заказ (от 5 рабочих дней);
- Экспресс доставка в любую точку России;
- Техническая поддержка проекта, помощь в подборе аналогов, поставка прототипов;
- Система менеджмента качества сертифицирована по Международному стандарту ISO 9001;
- Лицензия ФСБ на осуществление работ с использованием сведений, составляющих государственную тайну;
- Поставка специализированных компонентов (Xilinx, Altera, Analog Devices, Intersil, Interpoint, Microsemi, Aeroflex, Peregrine, Syfer, Eurofarad, Texas Instrument, Miteq, Cobham, E2V, MA-COM, Hittite, Mini-Circuits, General Dynamics и др.);

Помимо этого, одним из направлений компании «ЭлектроПласт» является направление «Источники питания». Мы предлагаем Вам помощь Конструкторского отдела:

- Подбор оптимального решения, техническое обоснование при выборе компонента;
- Подбор аналогов;
- Консультации по применению компонента;
- Поставка образцов и прототипов;
- Техническая поддержка проекта;
- Защита от снятия компонента с производства.



Как с нами связаться

Телефон: 8 (812) 309 58 32 (многоканальный)

Факс: 8 (812) 320-02-42

Электронная почта: org@eplast1.ru

Адрес: 198099, г. Санкт-Петербург, ул. Калинина, дом 2, корпус 4, литера А.