

THIS DRAWING IS UNPUBLISHED. RELEASED FOR PUBLICATION
 © COPYRIGHT - By - ALL RIGHTS RESERVED.

LOC	DIST	REVISIONS					
		P	LTR	DESCRIPTION	DATE	DWN	APVD
FT	0	K18		REVISED PER ECO-11-004587	11MAR11	RK	HMR

PHYSICAL PROPERTIES:
 HOUSING MATERIAL: THERMOPLASTIC, PC
 FLAMABILITY: UL94V-0
 COLOR: BLACK

TERMINAL:
 TERMINALS: BRASS, TIN PLATED
 SCREWS: 6-32 STEEL, NICKEL PLATED

MECHANICAL:
 PITCH: .437
 WIRE RANGE: 14-22 AWG
 RECOMMENDED TIGHTENING TORQUE: 12IN-LB

ELECTRICAL PROPERTIES:
 MAX CURRENT: 25A
 OPERATING VOLTAGE: 300V

ENVIRONMENTAL PROPERTIES:
 OPERATING TEMP: -40°C TO 120°C

- 1 SEE FIGURE.
- 2 PRELIMINARY PART NUMBER.
- 3 STAINLESS STEEL SCREWS.
- 4 WHITE INK STAMP.
- 5 TE CONNECTIVITY LOGO LOCATED APPROXIMATE AREA.

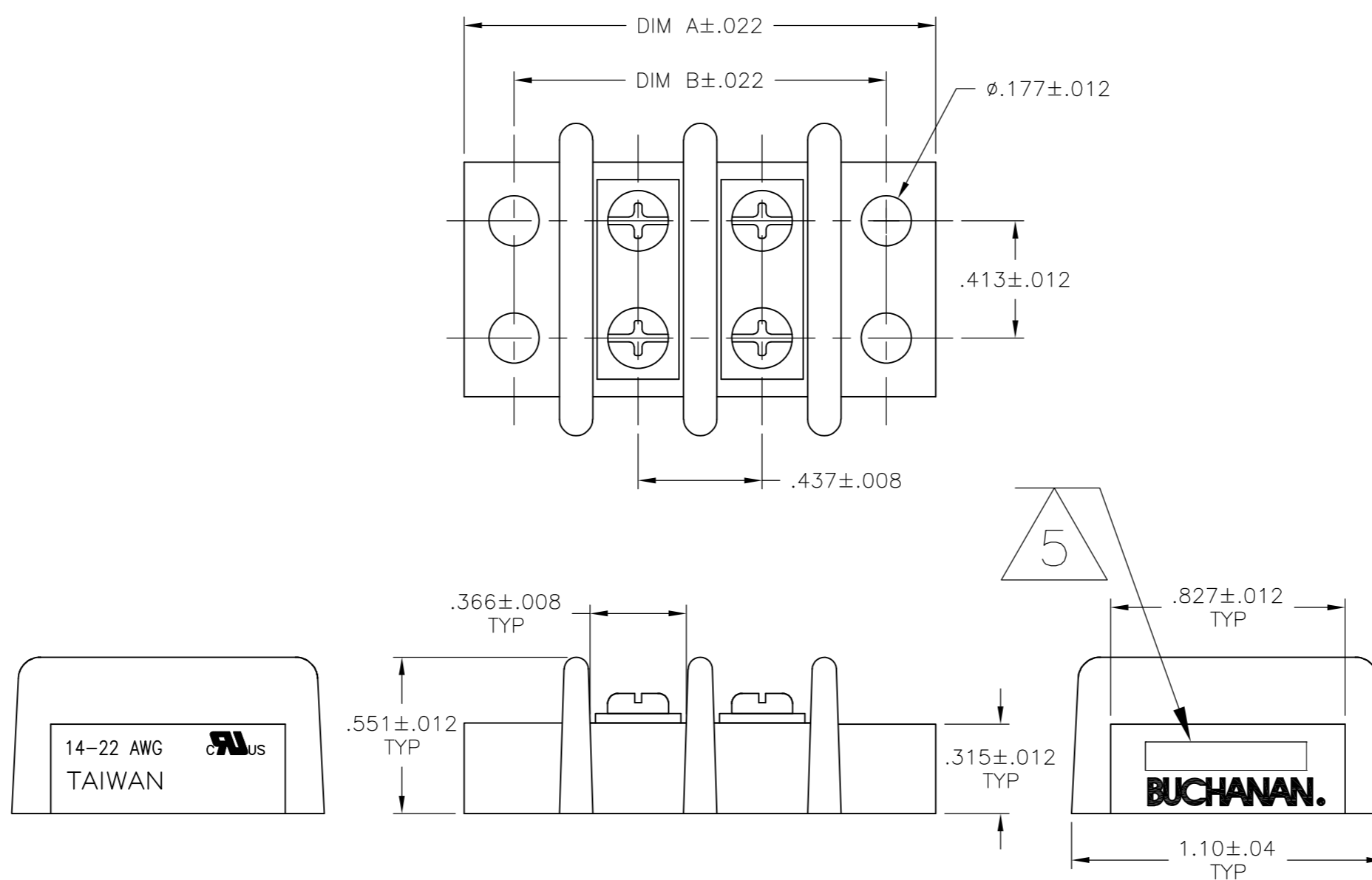

5.646	5.992	12	4-1546670-2
9.142	9.488	20	2-1546670-0
8.705	9.051	19	1-1546670-9
8.268	8.614	18	3-1546670-0
8.268	8.614	18	1-1546670-8
7.831	8.177	17	1-1546670-7
7.394	7.740	16	1-1546670-6
6.957	7.303	15	1-1546670-5
6.520	6.866	14	1-1546670-4
6.083	6.429	13	1-1546670-3
5.646	5.992	12	1-1546670-2
5.209	5.555	11	1-1546670-1
4.772	5.118	10	4-1546670-3
4.772	5.118	10	3-1546670-8
4.772	5.118	10	1-1546670-0
4.335	4.681	9	3-1546670-5
4.335	4.681	9	3-1546670-2
4.335	4.681	9	1546670-9
3.898	4.244	8	4-1546670-1
3.898	4.244	8	3-1546670-6
3.898	4.244	8	3-1546670-4
3.898	4.244	8	3-1546670-3
3.898	4.244	8	1546670-8
3.461	3.807	7	1546670-7
3.024	3.370	6	3-1546670-1
3.024	3.370	6	1546670-6
2.587	2.933	5	2-1546670-8
2.587	2.933	5	2-1546670-7
2.587	2.933	5	1546670-5
2.496	2.933	4	3-1546670-9
2.150	2.496	4	2-1546670-9
2.150	2.496	4	1546670-4
1.713	2.059	3	1546670-3
1.276	1.622	2	1546670-2
DIM B	DIM A	NO OF POS	PART NUMBER

THIS DRAWING IS A CONTROLLED DOCUMENT.

DWN	S SCHEGEL	4/4/03
CHK	C RICHARD	4/4/03
APVD	C RICHARD	4/4/03

TE Connectivity

DOUBLE ROW BARRIER STRIP W/ BINDING HD SCREW, .437 SPACING

SIZE	A2	CAGE CODE	00779	DRAWING NO	C=1546670	RESTRICTED TO	-
WEIGHT	-	SCALE	NTS	SHEET	1 of 3	REV	K18

CUSTOMER DRAWING

THIS DRAWING IS UNPUBLISHED. RELEASED FOR PUBLICATION
 © COPYRIGHT - By - ALL RIGHTS RESERVED.

LOC		DIST		REVISIONS			
P	LTR	DESCRIPTION	DATE	DWN	APVD		
FT	0	SEE SHEET 1	-	-	-		

DOUBLE SIDED, DOUBLE HOLE
QC TAB, QTY 5

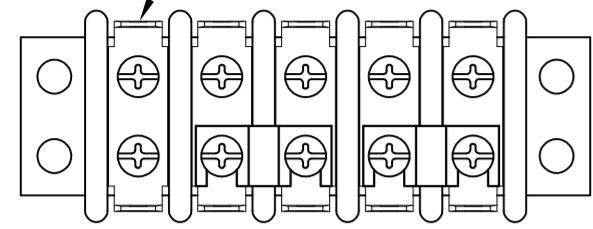

DOUBLE SIDED, DOUBLE HOLE
QC TAB, QTY 5

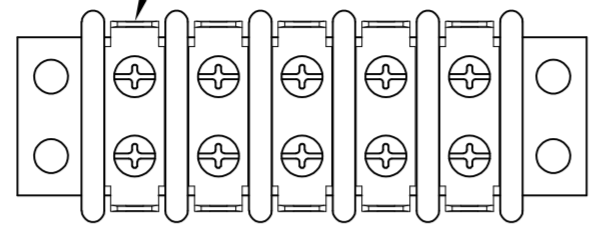

JUMPER, QTY 1

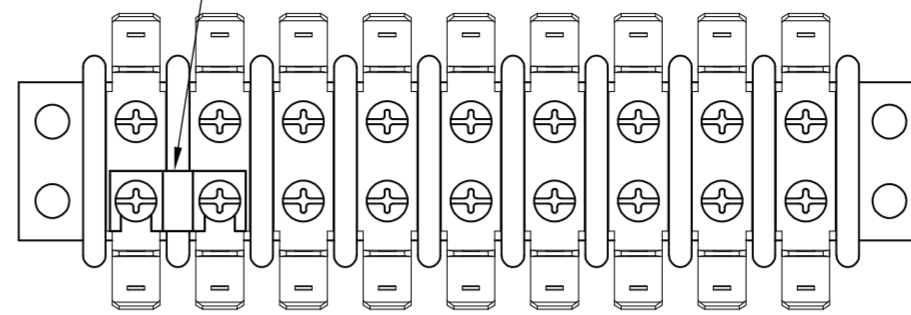

DOUBLE SIDED, DOUBLE HOLE
45° QC TAB, QTY 9

DOUBLE SIDED, DOUBLE HOLE
90° QC TAB, QTY 9

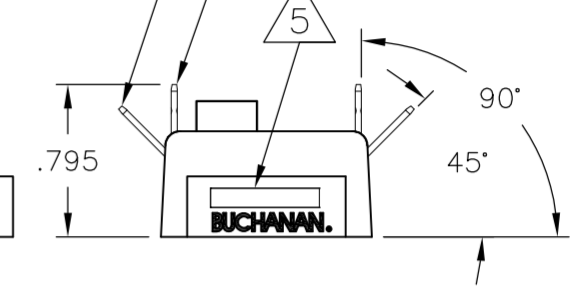

2-1546670-7

2-1546670-8

3-1546670-2

DOUBLE SIDED, DOUBLE HOLE
QC TAB, QTY 5

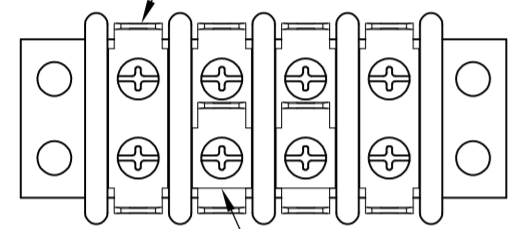

SINGLE SIDED, DOUBLE HOLE
QC TAB, QTY 6

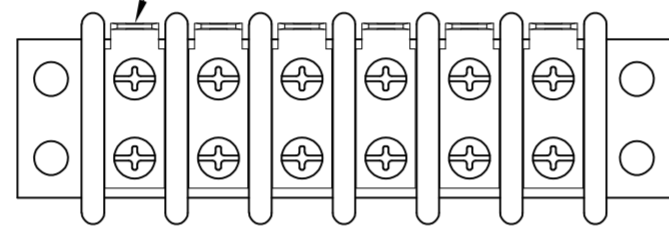

DOUBLE SIDED, DOUBLE HOLE
FLAT QC TAB, QTY 8.

JUMPER, QTY 2

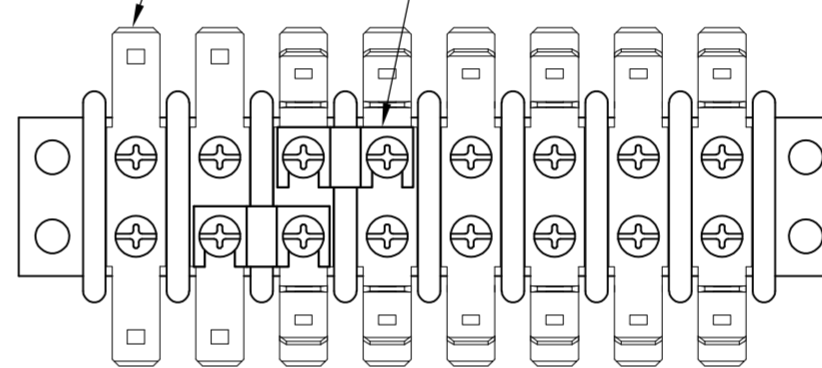

DOUBLE SIDED, DOUBLE HOLE
45° QC TAB, QTY 6

DOUBLE SIDED, DOUBLE HOLE
90° QC TAB, QTY 4

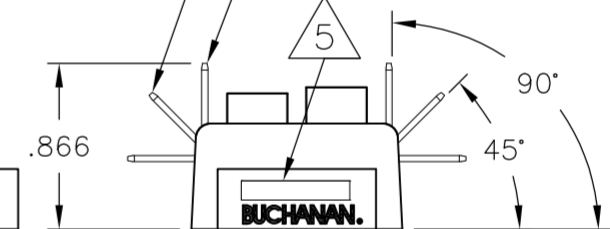

2-1546670-9

3-1546670-1

3-1546670-3

SINGLE SIDED, DOUBLE HOLE
QC TAB, QTY 18

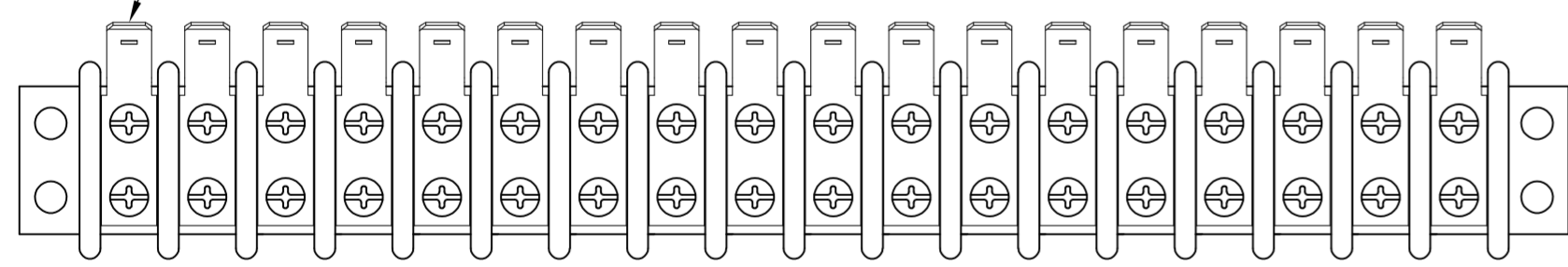

DOUBLE SIDED, DOUBLE HOLE
FLAT QC TAB, QTY 8.

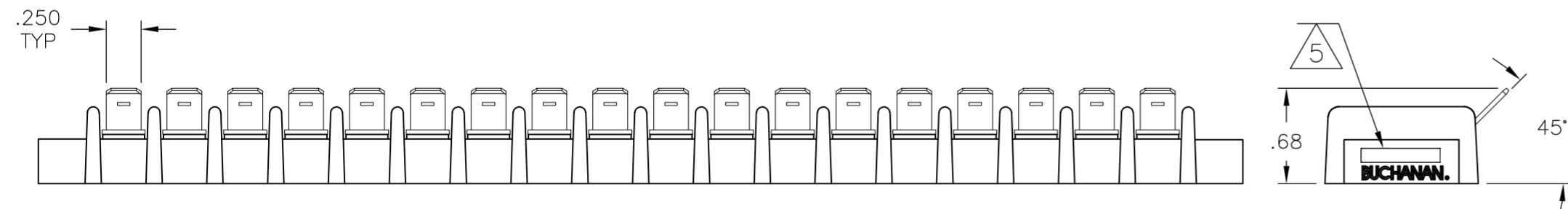
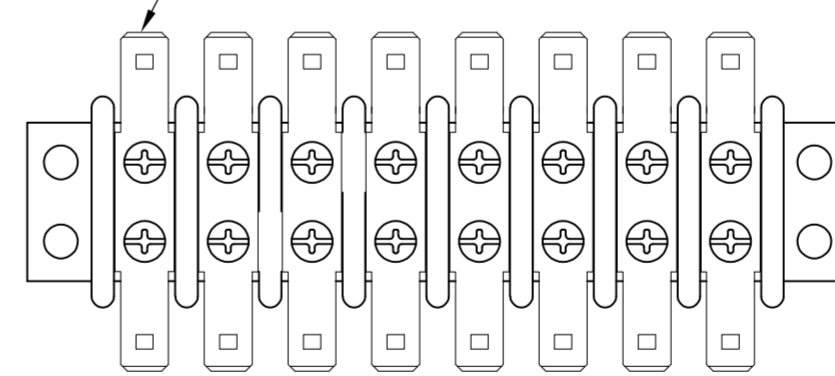

3-1546670-0

3-1546670-4

11.764	12.110	26	2-1546670-6
11.327	11.673	25	2-1546670-5
10.90	11.236	24	2-1546670-4
10.453	10.799	23	2-1546670-3
10.016	10.362	22	2-1546670-2
9.579	9.925	21	2-1546670-1
9.142	9.488	20	3-1546670-7
DIM B	DIM A	NO OF POS	PART NUMBER

THIS DRAWING IS A CONTROLLED DOCUMENT.		DWN	S SCHEGEL	4/4/03	 TE Connectivity							
DIMENSIONS: INCHES		CHK	C RICHARD	4/4/03								
TOLERANCES UNLESS OTHERWISE SPECIFIED:		APVD	C RICHARD	4/4/03								
0 PLC ± - 1 PLC ± - 2 PLC ± .01 3 PLC ± .005 4 PLC ± - ANGLES ± 3°		PRODUCT SPEC	NAME			DOUBLE ROW BARRIER STRIP W/ BINDING HD SCREW, .437 SPACING						
MATERIAL		FINISH	WEIGHT		SIZE	A2	CAGE CODE	00779	DRAWING NO	C=1546670	RESTRICTED TO	-
		CUSTOMER DRAWING		SCALE	NTS	SHEET	2 of 3	REV	K18			

THIS DRAWING IS UNPUBLISHED. RELEASED FOR PUBLICATION
 © COPYRIGHT - By - ALL RIGHTS RESERVED.

LOC		DIST		REVISIONS			
P	LTR	DESCRIPTION	DATE	DWN	APVD		
FT	0	SEE SHEET 1	-	-	-		

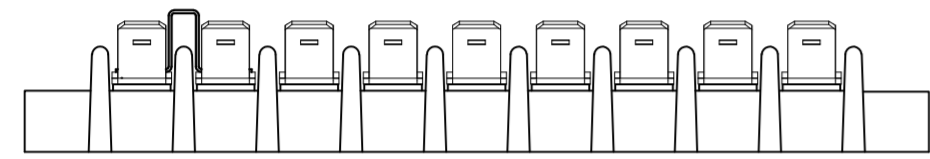
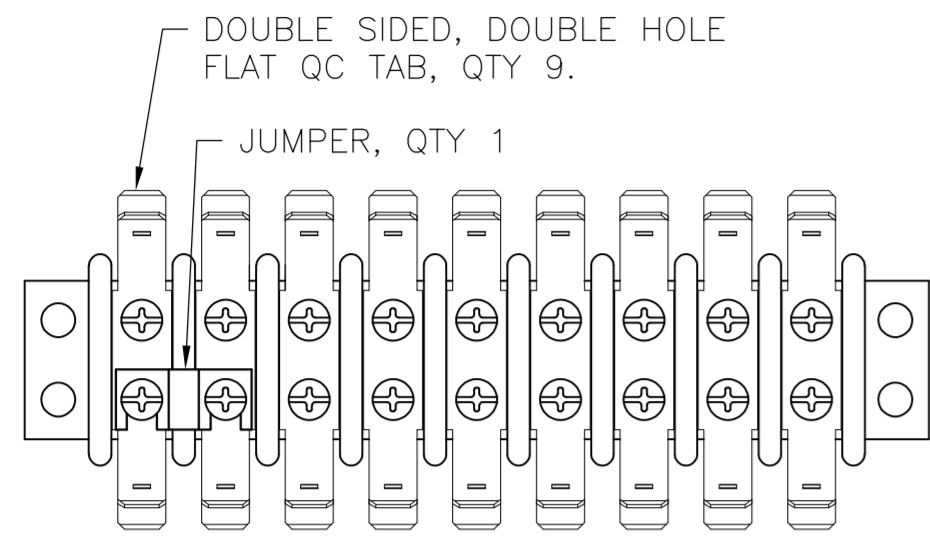

3-1546670-5

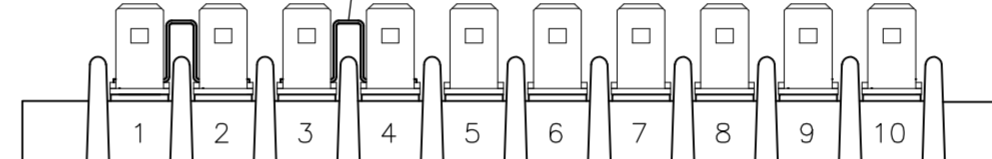
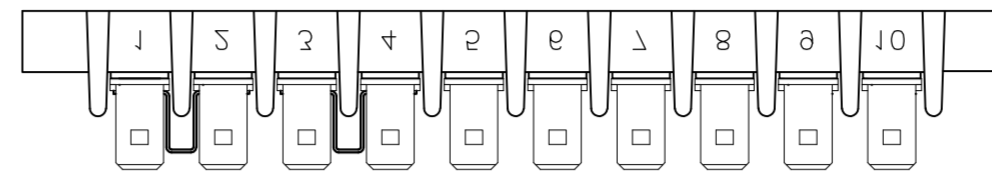
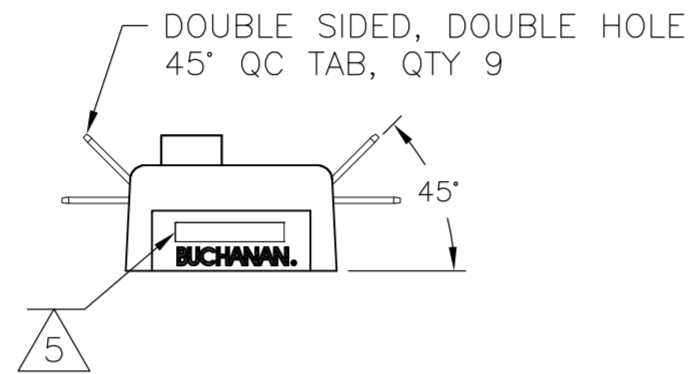

4-1546670-3

SINGLE SIDED, DOUBLE HOLE
 45° QC TAB, QTY 10

SINGLE SIDED, DOUBLE HOLE
 90° QC TAB, QTY 10

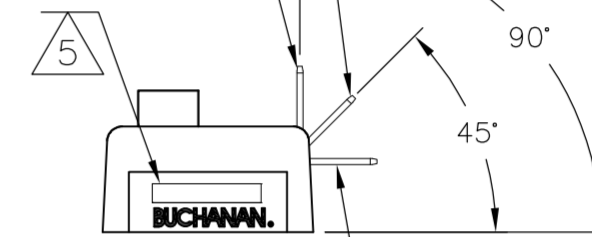

SINGLE SIDED, DOUBLE HOLE
 FLAT QC TAB, QTY 10

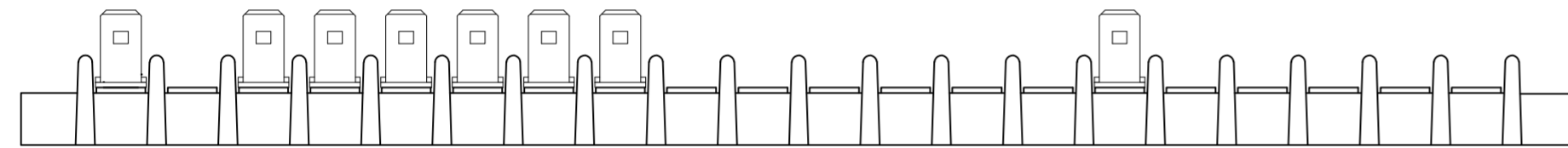

3-1546670-7

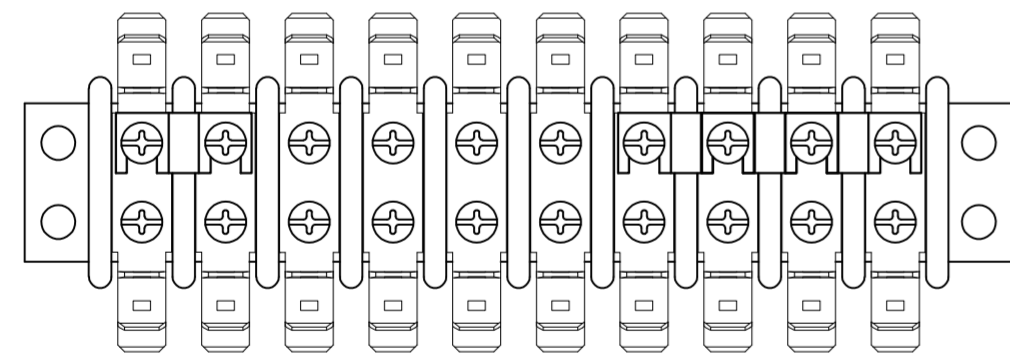
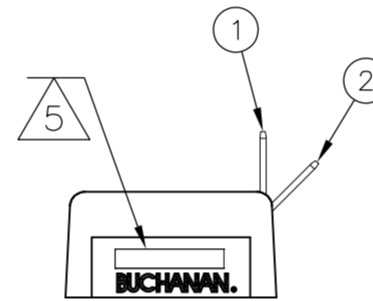

3-1546670-8

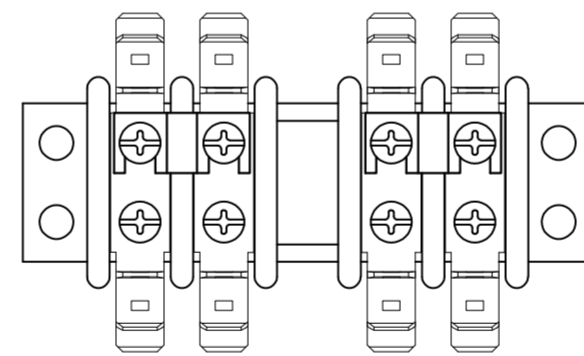
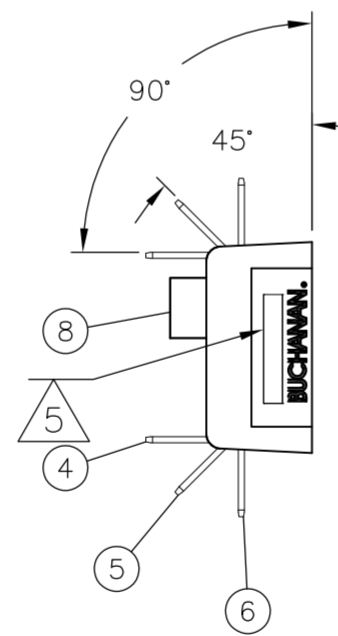

3-1546670-9

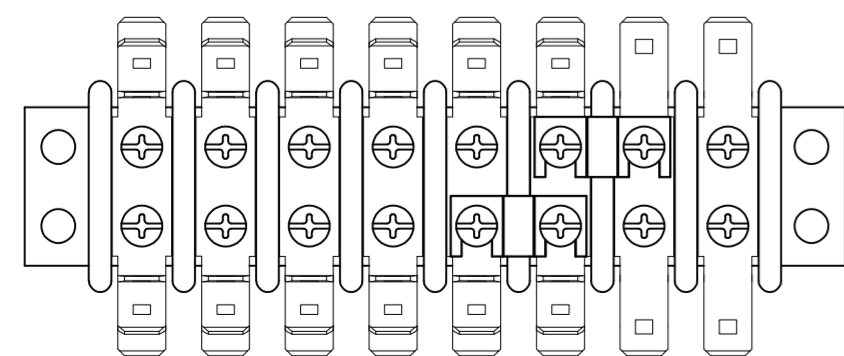
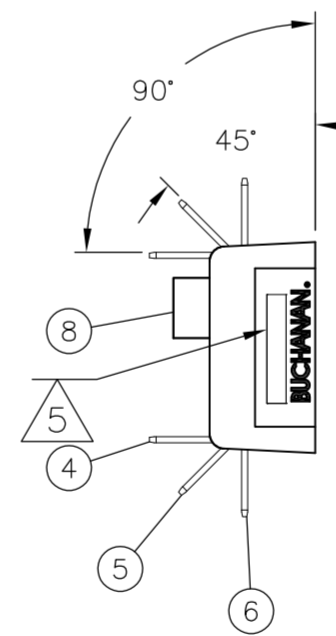

4-1546670-1

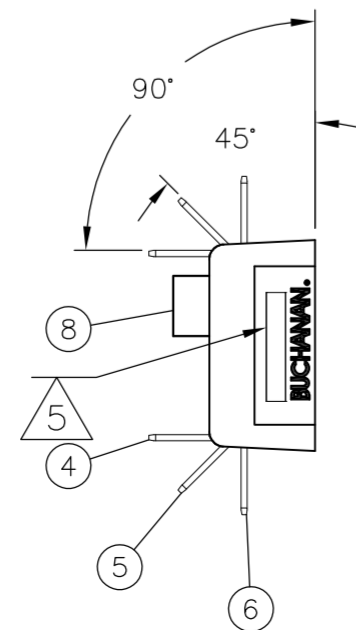

THIS DRAWING IS A CONTROLLED DOCUMENT.		DWN S SCHEGEL 4/4/03	TE Connectivity	
DIMENSIONS: INCHES		CHK C RICHARD 4/4/03		
TOLERANCES UNLESS OTHERWISE SPECIFIED:		APVD C RICHARD 4/4/03	NAME	
0 PLC ± -	1 PLC ± -	PRODUCT SPEC	DOUBLE ROW BARRIER STRIP W/ BINDING HD SCREW, .437 SPACING	
2 PLC ± .01	3 PLC ± .005	APPLICATION SPEC	SIZE A2	CAGE CODE 00779
4 PLC ± -	ANGLES ± 3'	WEIGHT -	DRAWING NO C-1546670	RESTRICTED TO -
MATERIAL -	FINISH -	CUSTOMER DRAWING	SCALE NTS	SHEET 3 of 3



Компания «ЭлектроПласт» предлагает заключение долгосрочных отношений при поставках импортных электронных компонентов на взаимовыгодных условиях!

Наши преимущества:

- Оперативные поставки широкого спектра электронных компонентов отечественного и импортного производства напрямую от производителей и с крупнейших мировых складов;
- Поставка более 17-ти миллионов наименований электронных компонентов;
- Поставка сложных, дефицитных, либо снятых с производства позиций;
- Оперативные сроки поставки под заказ (от 5 рабочих дней);
- Экспресс доставка в любую точку России;
- Техническая поддержка проекта, помощь в подборе аналогов, поставка прототипов;
- Система менеджмента качества сертифицирована по Международному стандарту ISO 9001;
- Лицензия ФСБ на осуществление работ с использованием сведений, составляющих государственную тайну;
- Поставка специализированных компонентов (Xilinx, Altera, Analog Devices, Intersil, Interpoint, Microsemi, Aeroflex, Peregrine, Syfer, Eurofarad, Texas Instrument, Miteq, Cobham, E2V, MA-COM, Hittite, Mini-Circuits, General Dynamics и др.);

Помимо этого, одним из направлений компании «ЭлектроПласт» является направление «Источники питания». Мы предлагаем Вам помощь Конструкторского отдела:

- Подбор оптимального решения, техническое обоснование при выборе компонента;
- Подбор аналогов;
- Консультации по применению компонента;
- Поставка образцов и прототипов;
- Техническая поддержка проекта;
- Защита от снятия компонента с производства.



Как с нами связаться

Телефон: 8 (812) 309 58 32 (многоканальный)

Факс: 8 (812) 320-02-42

Электронная почта: org@eplast1.ru

Адрес: 198099, г. Санкт-Петербург, ул. Калинина, дом 2, корпус 4, литера А.