

## Kxxx1GL Series

RoHS

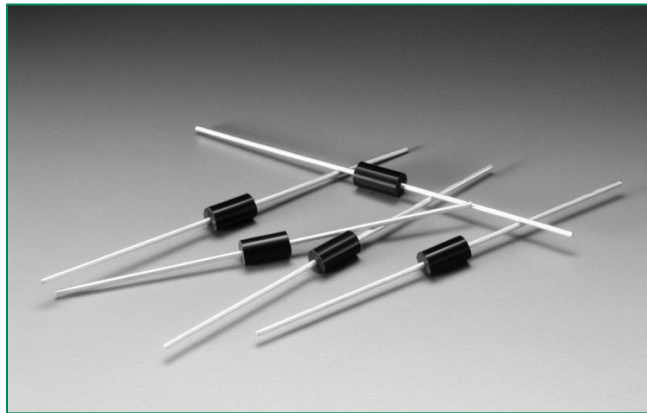

### Schematic Symbol

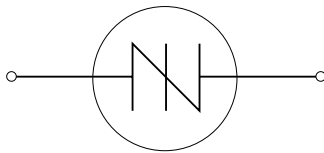

### Applications

Typical application circuit presented in Figure 10 of this data sheet (Typical Metal Halide Ignitor Circuit).

### Description

The Multipulse™ SIDAC is a voltage switch used in Metal-Halide lamp ignition circuits, as well as High Pressure Sodium lamp ignition circuits for outdoor street and area lighting. This robust solid-state switch is designed to handle lamp igniter applications requiring operation at ambient temperatures up to 90°C where igniter circuit components can raise SIDAC junction temperature up to 125°C, especially when the lamp element is removed or ruptured. Its excellent commutation time ( $t_{COMM}$ ) makes this robust product best suited for producing multiple pulses in each half cycle of 50/60 Hz line voltage. The Multipulse™ SIDAC is offered in a DO-15 axial leaded package.

Kxxx1GL SIDAC has a repetitive off-state blocking voltage ( $V_{DRM}$ ) of 180V to 270V minimum depending actual device type. Blocking capability is ensured by glass passivated junctions for best reliability. The package is epoxy encapsulated with tin plated copper alloy leads.

### Features

- AC circuit oriented
- RoHS Compliant
- Triggering Voltage of 200 to 380V

### Electrical Specifications

Symbol	Parameters	Test Conditions	Min	Max	Unit
$V_T$	On-state Voltage	$I_T=1A$		3	V
$I_{TRM}$	Peak Non-Repetitive Surge Current	$T_A=25^\circ C$ Pulse Wave = 10 $\mu s$ , Sine Wave, $f=120Hz$		50	A
$V_{BO}$	Breakover/Trigger Voltage	K2201GL K2401GL K2501GL K3601GL	200 220 240 348	230 250 265 380	V
$V_{DRM}$	Repetitive Peak Off-State Voltage	K2201GL K2401GL K2501GL K3601GL	180 190 200 270		V
$I_{T(RMS)}$	On-State RMS Current, $T_J < 125^\circ C$	50/60Hz Sine Wave		1	A
$I_H$	Dynamic Holding Current, $R=100 \Omega$	50/60Hz Sine Wave		30 TYP	mA
$R_S$	Switching Resistance, $R_S = \frac{(V_{BO} - V_S)}{(I_S - I_{BO})}$	50/60Hz Sine Wave	100		$\Omega$
$t_{COMM}$	Commutation Time $T_J < 125^\circ C$	See test circuit and waveform in Figure 9		100	$\mu sec$
$I_{BO}$	Breakover Current	50/60Hz Sine Wave		10	$\mu A$
$I_{TSM}$	Non-repetitive 1 cycle On-State peak value	60Hz 50Hz		20.0 16.7	A
$di/dt$	Critical Rate of Rise of On-State Current			150	A/ $\mu sec$
$dv/dt$	Critical Rate of Rise of Off-State Voltage			1500	V/ $\mu sec$
$T_S$	Storage Temperature Range		-40	+125	$^\circ C$

**Figure 1: Characteristics**

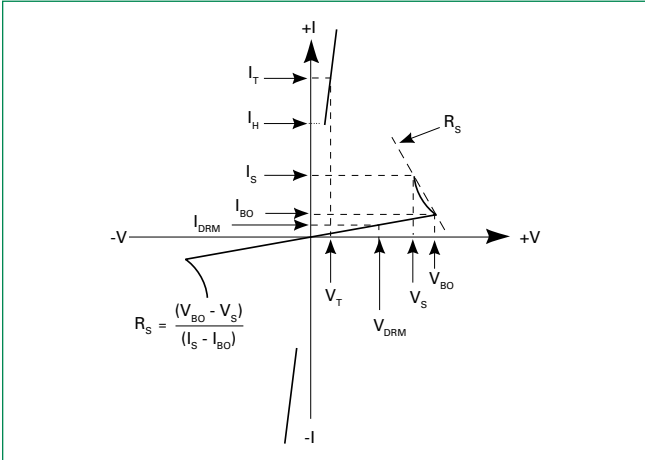

**Figure 2: Maximum Allowable Lead/Tab Temperature vs. On-State Current**

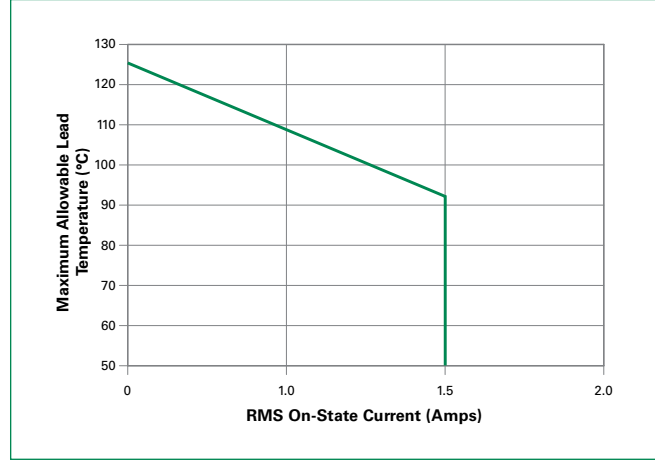

**Figure 3: Power Dissipation (Typical) vs. On-State Current**

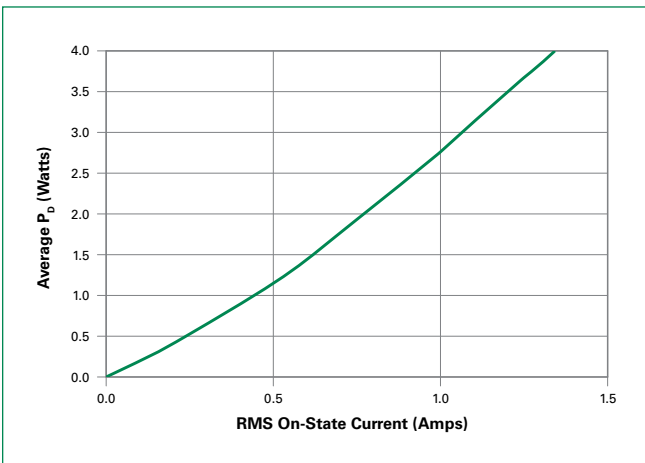

**Figure 4: V<sub>BO</sub> Change vs. Junction Temperature**

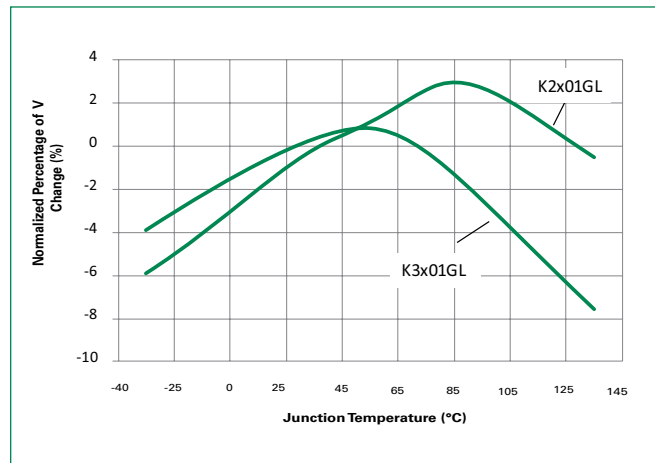

**Figure 5: Pulse On-State Current Rating**

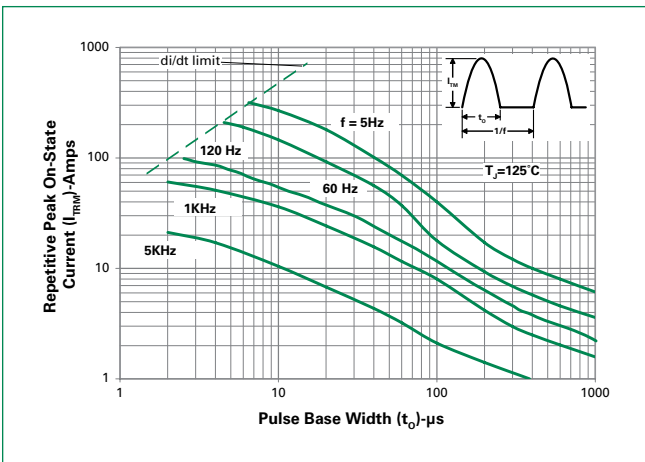

**Figure 6: Maximum Allowable Ambient Temperature vs. On-State Current**

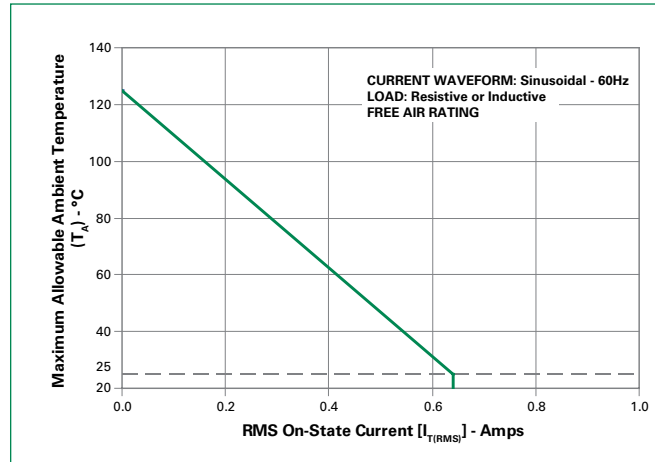

**Figure 7: Peak Surge Current vs Surge Current Duration**

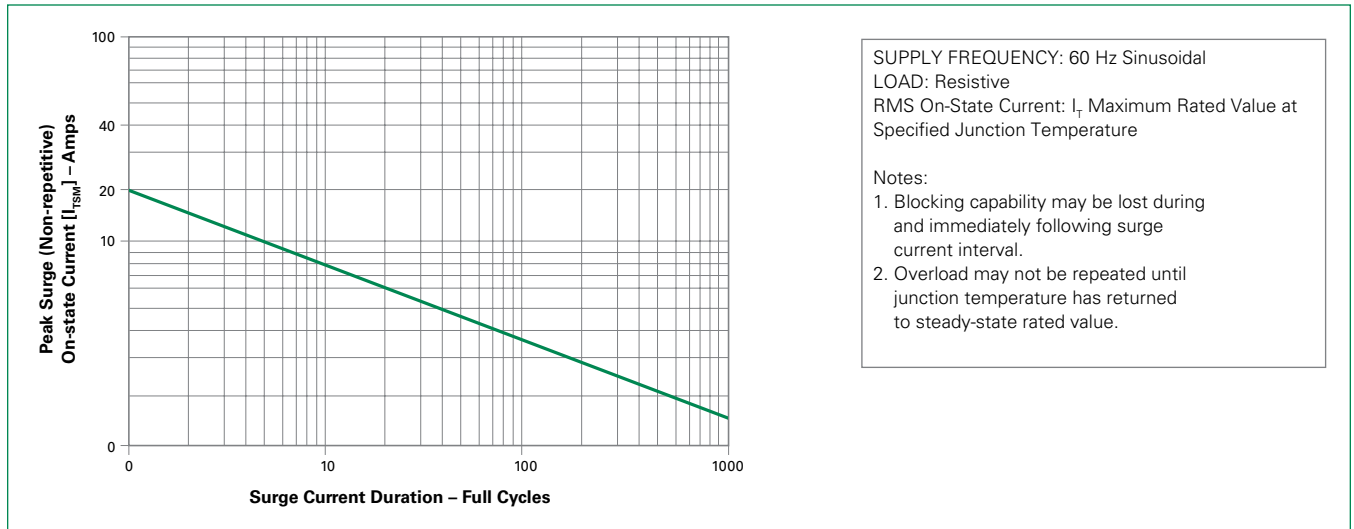

**Figure 8: Typical On-State Voltage vs On-State Current**

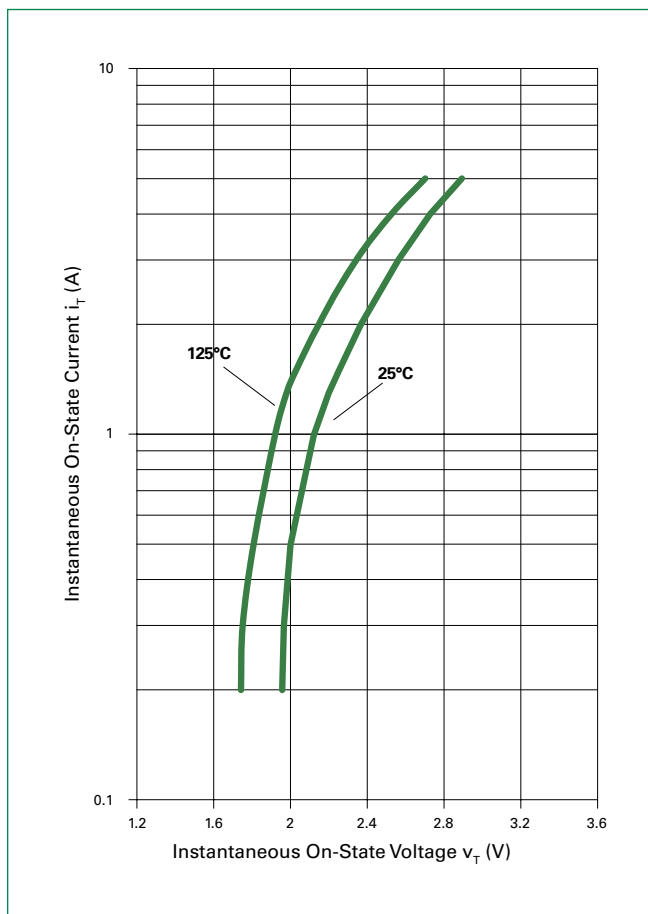

**Figure 9: Multipulse™ SIDAC  $t_{COMM}$  Commutation Time**

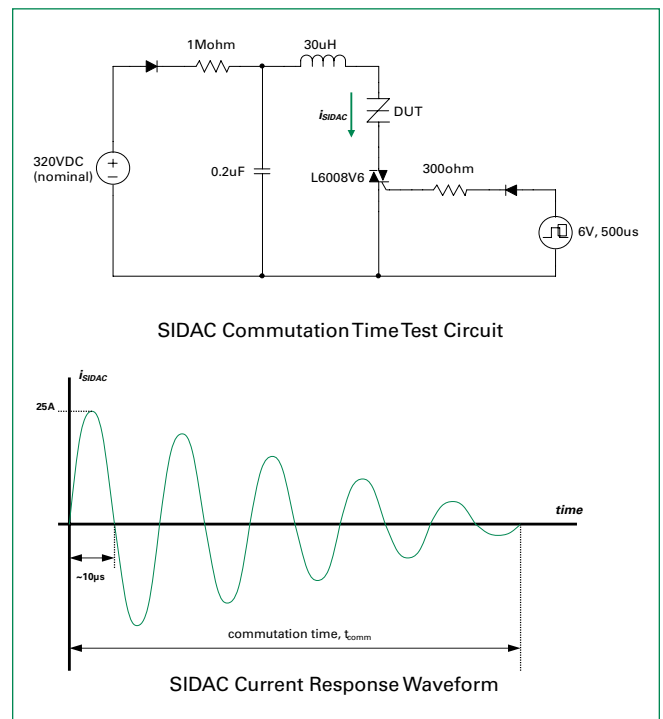

**Additional Information**



Datasheet



Resources



Samples

**Figure 10: Typical Metal Halide Ignitor Circuit**

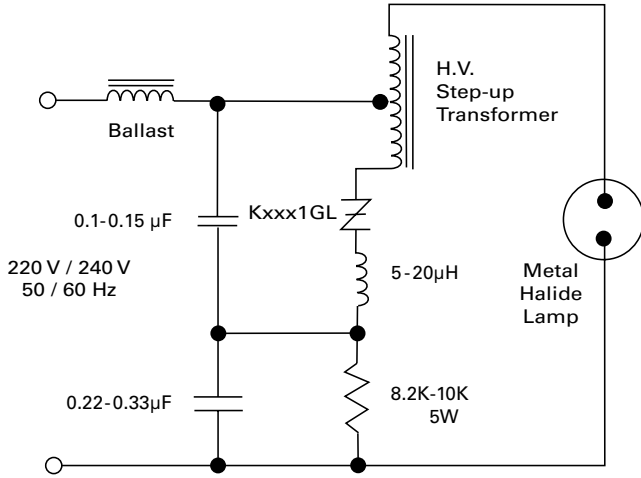

Note: With proper component selection, this circuit will produce three pulses for ignition of metal halide lamp that requires a minimum of three pulses at 5kV magnitude and >1uSec duration each at a minimum repetition rate of 3.3kHz.

**Soldering Parameters**

Reflow Condition		Pb – Free assembly
Pre Heat	- Temperature Min ( $T_{s(min)}$ )	150°C
	- Temperature Max ( $T_{s(max)}$ )	200°C
	- Time (min to max) ( $t_s$ )	60 – 180 secs
Average ramp up rate (Liquidus Temp) ( $T_L$ ) to peak		5°C/second max
$T_{s(max)}$ to $T_L$ - Ramp-up Rate		5°C/second max
Reflow	- Temperature ( $T_L$ ) (Liquidus)	217°C
	- Temperature ( $t_L$ )	60 – 150 seconds
Peak Temperature ( $T_p$ )		260 <sup>+0/-5</sup> °C
Time within 5°C of actual peak Temperature ( $t_p$ )		20 – 40 seconds
Ramp-down Rate		5°C/second max
Time 25°C to peak Temperature ( $T_p$ )		8 minutes Max.
Do not exceed		280°C

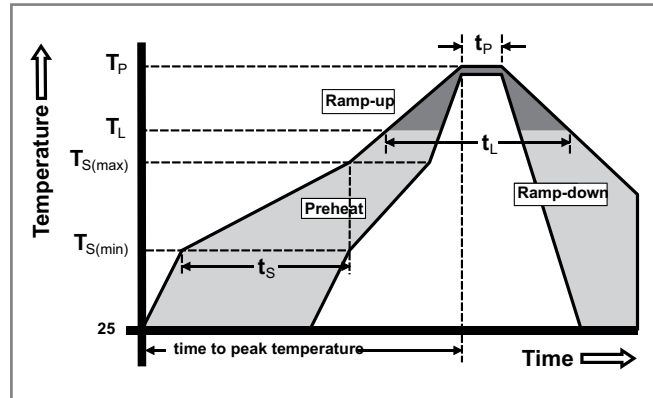

### Physical Specifications

<b>Terminal Finish</b>	100% Matte Tin Plated
<b>Body Material</b>	UL recognized epoxy meeting flammability classification 94V-0
<b>Lead Material</b>	Copper Alloy

Package	Weight / unit (mg)
<b>DO-15</b>	385

### Design Considerations

Careful selection of the correct device for the application's operating parameters and environment will go a long way toward extending the operating life of the Thyristor. Overheating and surge currents are the main killers of SIDACs. Correct mounting, soldering, and forming of the leads also help protect against component damage.

### Reliability/Environmental Tests

Test	Specifications and Conditions
<b>High Temperature Voltage Blocking</b>	MIL-STD-750: Method 1040, Condition A Rated $V_{DRM}$ (VAC-peak), 125°C, 1008 hours
<b>Temperature Cycling</b>	MIL-STD-750: Method 1051, 100 cycles; -40°C to 150°C, 15-minute dwell time
<b>Temperature / Humidity</b>	EIA/JEDEC: JESD22-A101 1008 hours; 160V - DC: 85°C; 85% relative humidity
<b>High Temp Storage</b>	MIL-STD-750: Method 1031 150°C, 1008 hours
<b>Low-Temp Storage</b>	-40°C, 1008 hours
<b>Thermal Shock</b>	MIL-STD-750: Method 1056 10 cycles; 0°C to 100°C; 5-minute dwell-time at each temperature; 10-sec (max) transfer time between temperature
<b>Autoclave</b>	EIA/JEDEC: JESD22-A102 168 hours (121°C at 2 ATMs) and 100% RH
<b>Resistance to Solder Heat</b>	MIL-STD-750: Method 2031 260°C, 10 seconds
<b>Solderability</b>	ANSI/J-STD-002: Category 3, Test A
<b>Repetitive Surge Life Testing</b>	Multi firings per half cycle at 60Hz in application circuit for 168 hours minimum

### Dimensions — DO-15 (G Package)

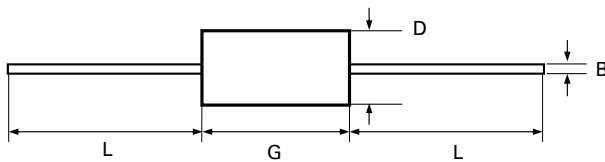

Dimension	Inches		Millimeters	
	Max	Max	Min	Max
B	0.028	0.034	0.711	0.864
D	0.120	0.140	3.048	3.556
G	0.235	0.270	5.969	6.858
L	1.000		25.400	

### Product Selector

Part Number	Switching Voltage Range		Blocking Voltage	Packages
	$V_{BO}$ Minimum	$V_{BO}$ Maximum	$V_{DRM}$	
K2201GL	200V	230V	180V	DO-15
K2401GL	220V	250V	190V	DO-15
K2501GL	240V	265V	200V	DO-15
K3601GL	340V	380V	270V	DO-15

**Packing Options**

Part Number	Package	Packing Mode	Base Quantity
Kxxx1GL	DO-15	Bulk	1000
Kxxx1GLRP		Tape & Reel	5000

Note: xxx = voltage

**DO-15 Embossed Carrier RP Specifications**

Meets all EIA RS-29-6 Standards

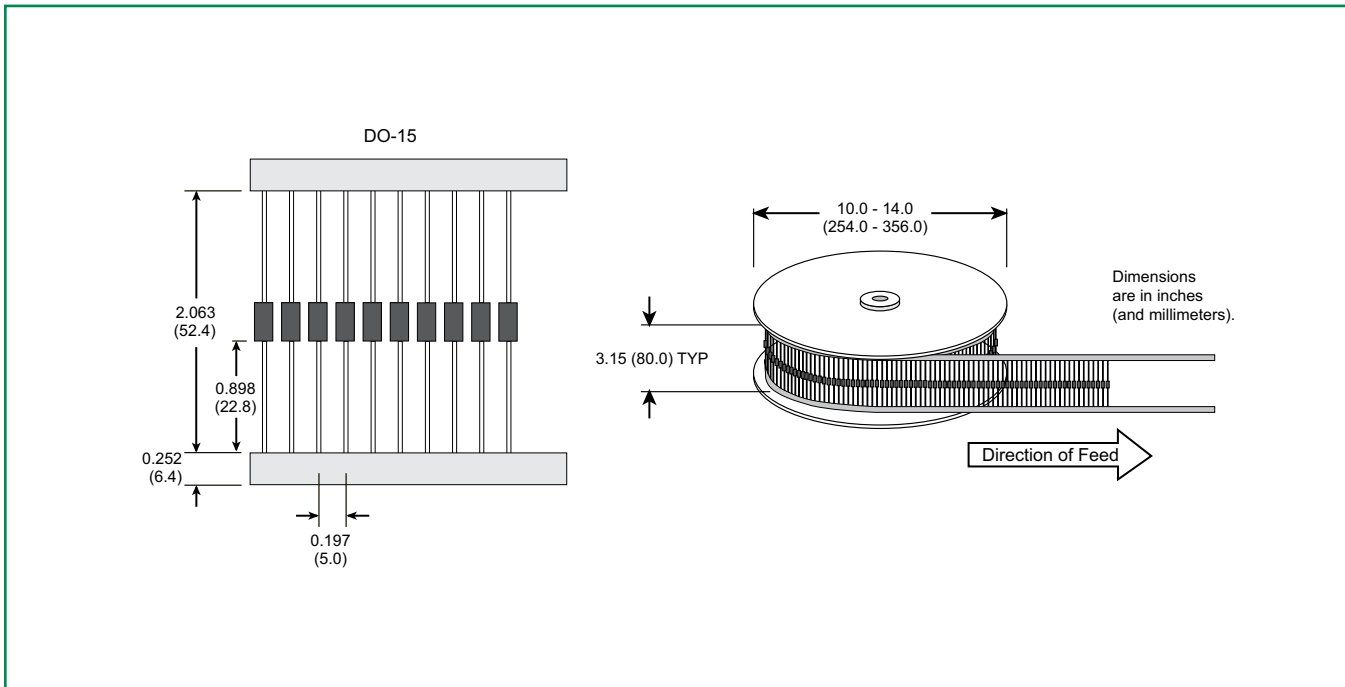

**Part Numbering System**

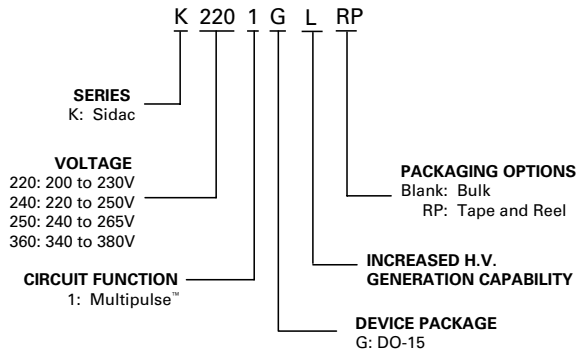

**Part Marking System**





Компания «ЭлектроПласт» предлагает заключение долгосрочных отношений при поставках импортных электронных компонентов на взаимовыгодных условиях!

Наши преимущества:

- Оперативные поставки широкого спектра электронных компонентов отечественного и импортного производства напрямую от производителей и с крупнейших мировых складов;
- Поставка более 17-ти миллионов наименований электронных компонентов;
- Поставка сложных, дефицитных, либо снятых с производства позиций;
- Оперативные сроки поставки под заказ (от 5 рабочих дней);
- Экспресс доставка в любую точку России;
- Техническая поддержка проекта, помощь в подборе аналогов, поставка прототипов;
- Система менеджмента качества сертифицирована по Международному стандарту ISO 9001;
- Лицензия ФСБ на осуществление работ с использованием сведений, составляющих государственную тайну;
- Поставка специализированных компонентов (Xilinx, Altera, Analog Devices, Intersil, Interpoint, Microsemi, Aeroflex, Peregrine, Syfer, Eurofarad, Texas Instrument, Miteq, Cobham, E2V, MA-COM, Hittite, Mini-Circuits, General Dynamics и др.);

Помимо этого, одним из направлений компании «ЭлектроПласт» является направление «Источники питания». Мы предлагаем Вам помощь Конструкторского отдела:

- Подбор оптимального решения, техническое обоснование при выборе компонента;
- Подбор аналогов;
- Консультации по применению компонента;
- Поставка образцов и прототипов;
- Техническая поддержка проекта;
- Защита от снятия компонента с производства.



#### Как с нами связаться

**Телефон:** 8 (812) 309 58 32 (многоканальный)

**Факс:** 8 (812) 320-02-42

**Электронная почта:** [org@eplast1.ru](mailto:org@eplast1.ru)

**Адрес:** 198099, г. Санкт-Петербург, ул. Калинина, дом 2, корпус 4, литера А.