



8060 Series

Alternate Action and Momentary Pushbutton Switches

Pushbutton



Features/Benefits

- Long travel
- Available with LED
- Long life contact design
- Epoxy terminal seal compatible with bottom wash cleaning
- RoHS compliant models available

Typical Applications

- Instrumentation
- Computers and peripherals
- Telecommunications and networking equipment



Models Available

Specifications

CONTACT RATING: Q contact material: 6 AMPS @ 120 V AC or 28 V DC; 3 AMPS @ 250 V AC. See page A-59 for additional ratings.

ELECTRICAL LIFE: 50,000 make-and-break cycles at full load.

CONTACT RESISTANCE: Below 20 mΩ typ. initial @ 2-4 V DC, 100 mA, for both silver and gold plated contacts.

INSULATION RESISTANCE: 10⁹Ω min.

DIELECTRIC STRENGTH: 1,000 Vrms min. @ sea level.

OPERATING TEMPERATURE: -30°C to 65°C

SOLDERABILITY: Per MIL-STD-202F method 208D, or EIA RS-186E method 9 (1 hour steam aging).

CAP INSTALLATION FORCE: 10 lbs. maximum permissible.

NOTE: Any models supplied with P, R, S, Q, B or G contact material are RoHS compliant.

NOTE: Specifications and materials listed above are for switches with standard options. For information on specific and custom switches, consult Customer Service Center.

Materials

CASE: Glass filled nylon 6/6 or diallyl phthalate (DAP), flame retardant (UL 94V-0).

PLUNGER: S, S1, S2 Options: Glass filled nylon or glass filled polyester (PBT) (UL 94V-0). L, L1 Options: Brass, nickel plated.

CAP & FRAME: Nylon, black standard.

BUSHING: Brass or zinc, nickel plated.

HOUSING: Stainless steel.

SWITCH SUPPORT: Brass or steel, matte-tin plated.

END CONTACTS: Q contact material: Coin silver, silver plated. See page A-59 for additional contact materials.

CENTER CONTACT & ALL TERMINALS: Q contact material: Copper alloy, silver plated. See page A-59 for additional contact materials.

TERMINAL SEAL: Epoxy. Refer to soldering and cleaning in Technical Data Chapter.

HARDWARE: Nut & Locking Ring: Brass, nickel plated; Lockwasher: Steel, nickel plated.

Build-A-Switch

To order, simply select desired option from each category and place in the appropriate box. Available options are shown and described on pages A-53 thru A-61. For additional options not shown in catalog, consult Customer Service Center. All models have epoxy terminal seal and are compatible with all "bottom-wash" PCB cleaning methods.



Switch Function

- 8161** SPDT On-On
- 8168** SPDT On-Mom.
- 8261** DPDT On-On

Actuator or Plunger

- S** .710" high plunger with .375" dia. cap
- J80** Snap-in
- J81** Snap-in with frame
- J82** Snap-in with frame for LED
- J86** Snap-in with frame & LED
- L** .740" high plunger with .395" dia. cap
- L1** .740" high plunger with .590" dia. cap
- S1** .615" high plunger with .200" dia. cap
- S2** .710" high plunger with .310" dia. cap

Bushing

- H** .300" high, flat, hi torque
- H9** .300" high, flat, hi torque
- NONE** No bushing choice required
- Y3** 7.6mm, keyway

Terminations

- A** Right angle, PC thru-hole
- AV2** Vertical right angle, PC thru-hole
- C** PC Thru-hole
- Z** Solder lug
- A3** Right angle, snap-in, PC thru-hole
- AV3** Vertical right angle, snap-in, PC thru-hole
- V3** .460" high, V-bracket
- V4** .630" high, V-bracket
- V6** .460" high, V-bracket
- V21** .555" high, snap-in V-bracket
- V31** .460" high, snap-in V-bracket
- W** .750" long, wire wrap
- Z3** Quick connect

Contact Material

- B** Gold
- P** Gold, matte-tin
- Q** Silver
- S** Silver, matte-tin
- G** Gold over silver
- R** Gold over silver, matte-tin

Seal

- E** Epoxy
- I** Epoxy potted base

Cap Color

- 2** Black
- 1** White
- 3** Red
- 4** Orange
- 5** Yellow
- 9** Gray

Frame Color

- 2** Black

LED Color

- 3** Red
- NONE** Models without LED



29 Aug 18

8060 Series Alternate Action and Momentary Pushbutton Switches



A
Pushbutton

SWITCH FUNCTION

NO. POLES	MODEL NO.	SWITCH FUNCTION		CONNECTED TERMINALS		SCHEMATIC
		POS. 1	POS. 2	POS. 1	POS. 2	
		C&K marking this side		C&K marking this side		
SP	8161 8168	ON	ON	2-3	2-1	
		ON	MOM.	2-3	2-1	
SPDT						
Part number shown: 8161SHZQE						
DP	8261	ON	ON	2-3-5-6	2-1-5-4	
DPDT						
Part number shown: 8261SHZQE						

MOM. = Momentary

All models with all options when ordered with G or Q contact material.

ACTUATOR—SNAP-IN FRONT MOUNT

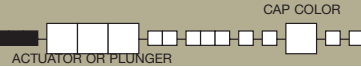

OPTION CODE	CAP COLOR
2	BLACK
1	WHITE
3	RED
4	ORANGE
5	YELLOW
9	GRAY

J80 SNAP-IN



J81 SNAP-IN WITH BLACK FRAME



Cap Finish: matte.
 Other colors available, consult Customer Service Center.
 Available with C, W, Z or Z3 terminations.
 NOTE: Caps & frames available separately, see pages A-60 and A-61.

Dimensions are shown: Inches (mm)
 Specifications and dimensions subject to change



29 Aug 18



8060 Series Alternate Action and Momentary Pushbutton Switches

ACTUATOR—SNAP-IN FRONT MOUNT



Pushbutton

J82 SNAP-IN WITH BLACK FRAME FOR LED



Available with C, W, Z or Z3 terminations.

LED not included.
For LED information, see page A-61.

NOTE: Caps & frames available separately, see pages A-60 and A-61.

Other colors available, consult Customer Service Center.

OPTION CODE	CAP COLOR
2	BLACK
1	WHITE
3	RED
4	ORANGE
5	YELLOW
9	GRAY

* Increase this dimension to .620/.625 (15,75/15,88) for .091/.125 (2,31/3,18) thick panels.

ACTUATOR—SNAP-IN FRONT MOUNT



J86 SNAP-IN WITH BLACK FRAME AND LED



8161J86ZQE223
SPDT



Available with C, W, Z or Z3 terminations and SPDT models only.

NOTE: Caps & frames available separately, see pages A-60 and A-61.

Other colors available, consult Customer Service Center.

OPTION CODE	CAP COLOR
2	BLACK
1	WHITE
3	RED
4	ORANGE
5	YELLOW
9	GRAY

OPTION CODE	LED COLOR
3	RED

For LED information, see page A-61.

* Increase this dimension to .620/.625 (15,75/15,88) for .091/.125 (2,31/3,18) thick panels.



Dimensions are shown: Inches (mm)
Specifications and dimensions subject to change



8060 Series Alternate Action and Momentary Pushbutton Switches



S PLUNGER WITH CAP P/N 7527



S1 PLUNGER WITH CAP P/N 7089

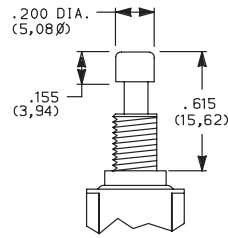

S2 PLUNGER WITH CAP P/N 8018

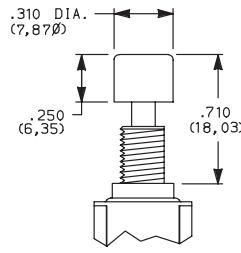

S, S1, S2 plunger dimensions.



Plunger material: Glass filled nylon or glass filled polyester (UL 94V-0).

L PLUNGER WITH CAP P/N 8941



L1 PLUNGER WITH CAP P/N 8940



L, L1 plunger dimensions.



Plunger Material: Brass, chrome plated.

OPTION CODE	CAP COLOR
2	BLACK
1	WHITE
3	RED
4	ORANGE
5	YELLOW
9	GRAY

Cap Finish: gloss. Cap supplied not installed. Other colors available, consult Customer Service Center.

NOTE: When selecting plunger and cap option, bushing selection must also be made, see below.



H .300" HIGH THREADED, FLAT

H9 .300" HIGH UNTHREADED, FLAT

NONE NO BUSHING CHOICE REQUIRED (JXX ACTUATORS)

Y3 7.6mm THREADED, KEYWAY



H bushing standard with C, W, Z or Z3 terminations. H9 bushing standard with A, A3, AV2, AV3, or V3-V31 terminations.

Withstands 12 in./lbs. of torque with no distortion.

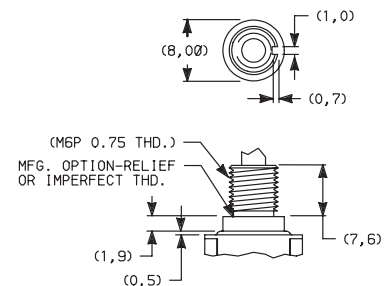

Withstands 12 in./lbs. of torque with no distortion.

NOTE: When selecting bushing option, plunger selection must also be made, see above. No bushing option choice required when any JXX actuator option is selected.

PANEL MOUNTING

1/4 IN. BUSHING



Without Locking Ring



With Standard Locking Ring



With Small Locking Ring

METRIC BUSHING



Without Locking Ring



With Locking Ring

NOTE: Two mounting nuts, locking ring and lockwasher supplied standard with threaded bushings. Optional mounting nut and locking ring styles and finishes available, see section "Technical Data and Additional Hardware".



Dimensions are shown: Inches (mm)
Specifications and dimensions subject to change



8060 Series

Alternate Action and Momentary Pushbutton Switches

TERMINATIONS



Pushbutton
A

C PC THRU-HOLE

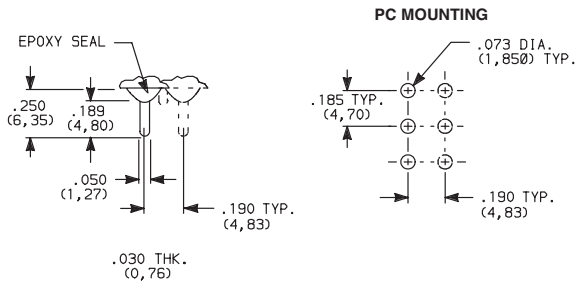

SPDT and DPDT

Z SOLDER LUG

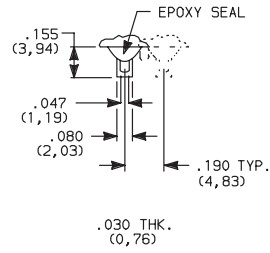

SPDT and DPDT

Not available with P, S or R contact material.

Z3 QUICK CONNECT

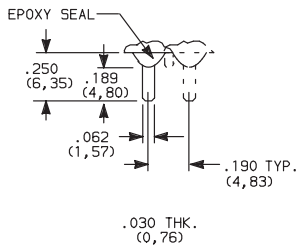

SPDT and DPDT

Not available with P, S or R contact material.
Mating quick connector available;
order part number 530100000, page A-61.

W WIRE WRAP

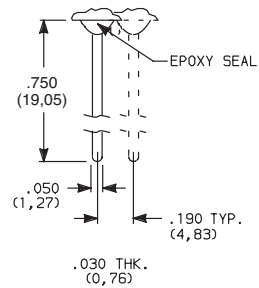

SPDT and DPDT

A RIGHT ANGLE, PC THRU-HOLE



8161SH9ABE2
SPDT

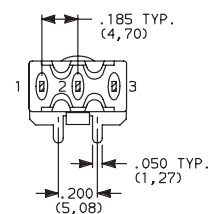
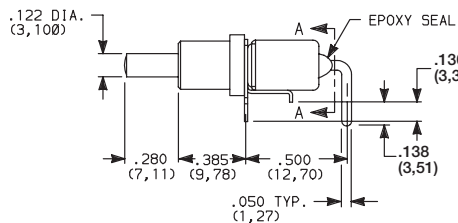
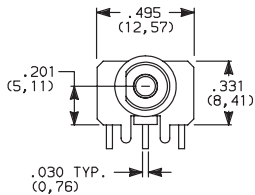

SECTION A-A

A3 RIGHT ANGLE, SNAP-IN, PC THRU-HOLE



PC MOUNTING

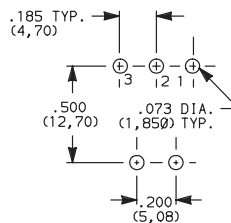

Not available with I seal.
Terminal bend radii and lead-in manufacturing option.

NOTE: PC pattern must clear switch support leg.



Dimensions are shown: Inches (mm)
Specifications and dimensions subject to change

8060 Series Alternate Action and Momentary Pushbutton Switches



A
Pushbutton

TERMINATIONS

A RIGHT ANGLE, PC THRU-HOLE



8261SH9ABE2
DPDT

A3 RIGHT ANGLE, SNAP-IN, PC THRU-HOLE

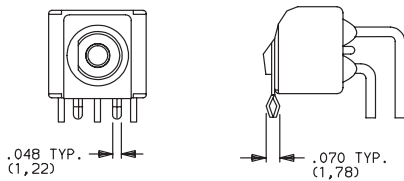

PC MOUNTING



Not available with I seal.
Terminal bend radii and lead-in manufacturing option.

AV2 VERTICAL RIGHT ANGLE, PC THRU-HOLE, .150" PITCH

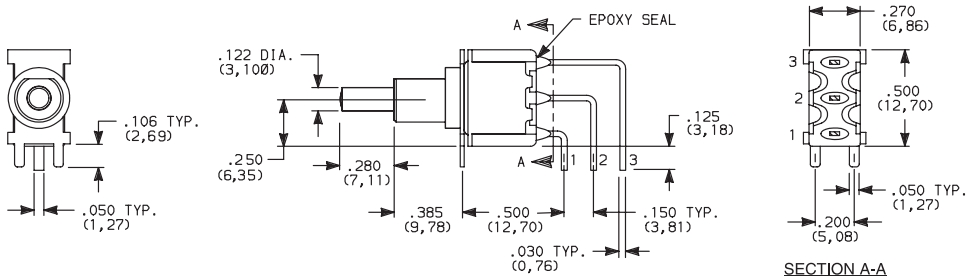

8161SH9AV2BE2
SPDT

AV3 VERTICAL RIGHT ANGLE, SNAP-IN, PC THRU-HOLE, .150" PITCH



PC MOUNTING



Not available with I seal.
Terminal bend radii and lead-in manufacturing option.





8060 Series Alternate Action and Momentary Pushbutton Switches

TERMINATIONS



Pushbutton

A

AV2 VERTICAL RIGHT ANGLE, PC THRU-HOLE, .150" PITCH



8261SH9AV2BE2
DPDT



SECTION A-A

AV3 VERTICAL RIGHT ANGLE, SNAP-IN, PC THRU-HOLE, .150" PITCH



PC MOUNTING

Not available with I seal.
Terminal bend radii and lead-in manufacturing option.

V6 VERTICAL MOUNT, V-BRACKET

V21 VERTICAL MOUNT, V-BRACKET, SNAP-IN

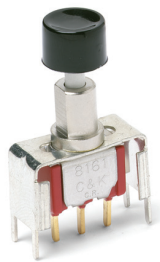

8161SH9_BE2
SPDT

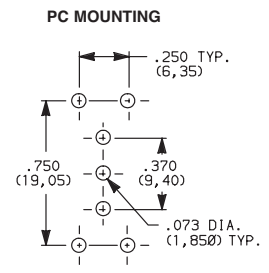
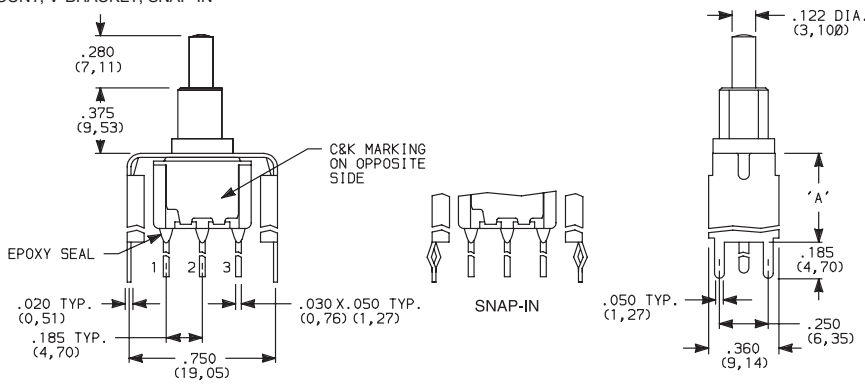

PC MOUNTING

OPTION CODE	DIM 'A'
V21	.555 (14,10)
V6	.460 (11,68)

Not available with I seal.

V6 VERTICAL MOUNT, V-BRACKET

V21 VERTICAL MOUNT, V-BRACKET, SNAP-IN



8261SH9_BE2
DPDT

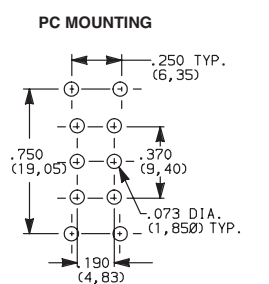
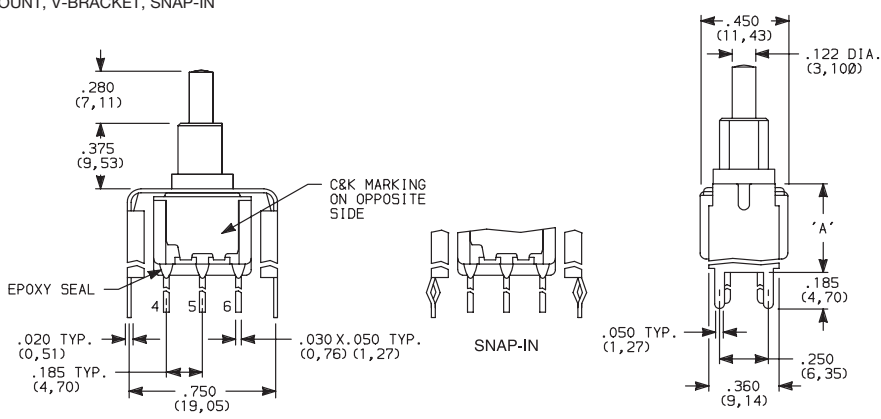

PC MOUNTING

OPTION CODE	DIM 'A'
V21	.555 (14,10)
V6	.460 (11,68)

Not available with I seal.

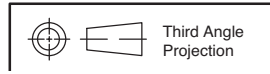

29 Aug 18

Dimensions are shown: Inches (mm)
Specifications and dimensions subject to change

8060 Series Alternate Action and Momentary Pushbutton Switches



A
Pushbutton

TERMINATIONS

V3, V4 VERTICAL MOUNT, V-BRACKET

V31 VERTICAL MOUNT, V-BRACKET, SNAP-IN

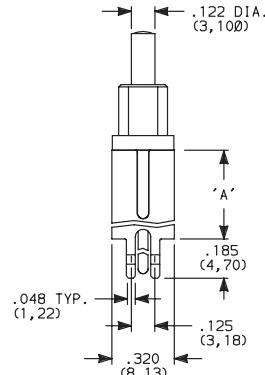
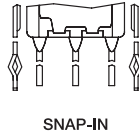

PC MOUNTING

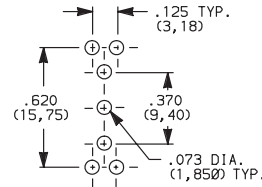

8161SH9_BE2
SPDT

OPTION CODE	DIM 'A'
V3, V31	.460 (11,68)
V4	.630 (16,00)

Not available with I seal.

V3, V4 VERTICAL MOUNT, V-BRACKET

V31 VERTICAL MOUNT, V-BRACKET, SNAP-IN

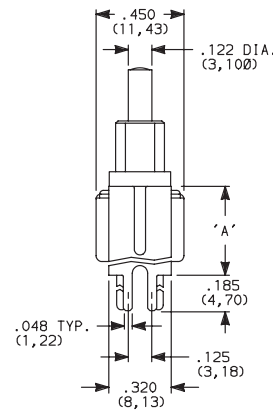
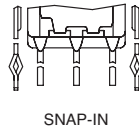
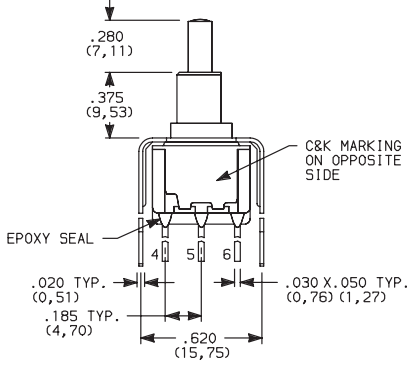

PC MOUNTING

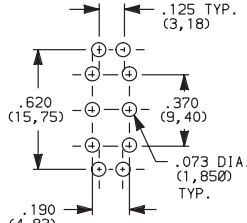

8261SH9_BE2
DPDT

OPTION CODE	DIM 'A'
V3, V31	.460 (11,68)
V4	.630 (16,00)

Not available with I seal.

CONTACT MATERIAL

OPTION CODE	CONTACT MATERIAL	TERMINAL PLATING	RATINGS	
B	GOLD ¹	GOLD ¹	LOW LEVEL/DRY CIRCUIT	0.4 VA MAX. @ 20 V AC OR DC MAX.
P		MATTE-TIN ⁶		
Q	SILVER ^{4,5}	SILVER ⁵	POWER	6 AMPS @ 120 V AC OR 28 V DC; 3 AMPS @ 250 V AC.
S		MATTE-TIN ⁶		
G	GOLD OVER SILVER ^{2,3}	GOLD ³	LOW LEVEL/DRY CIRCUIT OR POWER	0.4 VA MAX @ 20 V AC OR DC MAX. OR 6 AMPS @ 120 V AC OR 28 V DC; 3 AMPS @ 250 V AC.
R		MATTE-TIN ⁶		

* Note: See Technical Data section of this catalog for RoHS compliant and compatible definitions and specifications.

¹ CONTACTS & TERMINALS: Copper alloy, with gold plate over nickel plate.

² END CONTACTS: Coin silver, with gold plate over nickel plate.

³ CENTER CONTACTS & ALL TERMINALS: Copper alloy, with gold plate over nickel plate.

⁴ END CONTACTS: Coin silver, silver plated.

⁵ CENTER CONTACT & ALL TERMINALS: Copper alloy, silver plated.

⁶ TERMINALS: Copper alloy, with matte-tin over nickel plate.

All models with all options when ordered with S, R, G, or Q contact material.

B contact material standard with all terminations except C, Z & Z3.

Q contact material standard with C, Z & Z3 terminations.

P, S & R contact materials not available with Z & Z3 terminations.

NOTE: Any models supplied with P, S, R, Q, B or G contact material are RoHS compliant.

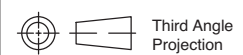

Dimensions are shown: Inches (mm)
Specifications and dimensions subject to change



29 Aug 18



8060 Series

Alternate Action and Momentary Pushbutton Switches

SEAL

Pushbutton
A

E EPOXY SEAL



I EPOXY POTTED BASE



NOTE: Available with C, W, Z, Z3 terminations only.

AVAILABLE HARDWARE

Cap



PART NO.

- 708901000 WHITE
- 708902000 BLACK
- 708903000 RED
- 708904000 ORANGE
- 708905000 YELLOW
- 708909000 GRAY

Material: Nylon
Finish: Gloss

Cap



PART NO.

- 752701000 WHITE
- 752702000 BLACK
- 752703000 RED
- 752704000 ORANGE
- 752705000 YELLOW
- 752709000 GRAY

Material: Nylon
Finish: Gloss

Cap



PART NO.

- 801801000 WHITE
- 801802000 BLACK
- 801803000 RED
- 801804000 ORANGE
- 801805000 YELLOW
- 801809000 GRAY

Material: Nylon
Finish: Gloss

Cap, Snap-fitting plunger



PART NO.

- 452D01000 WHITE
- 452D02000 BLACK
- 452D03000 RED
- 452D04000 ORANGE
- 452D05000 YELLOW
- 452D09000 GRAY

Material: Nylon
Finish: Gloss

Cap, Snap-fitting plunger



PART NO.

- 894101000 WHITE
- 894102000 BLACK
- 894103000 RED
- 894104000 ORANGE
- 894105000 YELLOW
- 894109000 GRAY

Material: Nylon
Finish: Gloss

Cap, J80, J81 & J82 options only

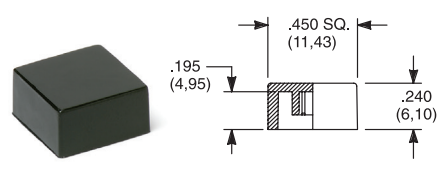

PART NO.

- 484601000 WHITE
- 484602000 BLACK
- 484603000 RED
- 484604000 ORANGE
- 484605000 YELLOW
- 484609000 GRAY

Material: Nylon
Finish: Gloss

PART NO.

- 798201000 WHITE
- 798202263 BLACK
- 798203000 RED
- 798204000 ORANGE
- 798205000 YELLOW
- 798209000 GRAY

Material: Nylon
Finish: Matte

Cap, J86 & J96 options only



PART NO.

- 459701000
- 459702000
- 459703000
- 459704000
- 459705000
- 459709000

Material: Nylon
Finish: Matte

Frame



PART NO.

- 615602263 BLACK

Material: Nylon
Finish: Matte

Frame



PART NO.

- 613302263 BLACK

Material: Nylon
Finish: Matte

NOTE: Additional nuts, locking rings and lockwashers available separately, see section "Technical Data and Additional Hardware".
Other cap & frame colors available, consult Customer Service Center.



Third Angle
Projection



29 Aug 18

8060 Series Alternate Action and Momentary Pushbutton Switches



A
Pushbutton

AVAILABLE HARDWARE

Fits Z3 Termination
female connector



PART NO.
530100000

Available in loose pieces.

Frames snap into panel opening and are independent from switch mounting. Accurate positioning of the PC mounted switch relative to the panel opening is necessary to provide proper clearance between actuator and frame. Available in two basic styles and four panel thicknesses .047-.125 in. Material: Nylon. Finish: Matte.

TYPICAL APPLICATION



.090" (2,29) PANEL THK. .125" (3,18) PANEL THK.

PART NO.
432702263

PART NO.
432802263 BLACK

PANEL MOUNTING



Panel Inserts



Above frames (part nos. 432XXXXXX) are also available with insert which accepts LED for indicator light assembly. Order insert separately from frame. Blank insert panel (without hole for LED) also available. **LED not included.**

PANEL INSERT
WITH HOLE FOR LED

PART NO.
894902000

BLANK PANEL INSERT
WITHOUT HOLE FOR LED

PART NO.
476602000 BLACK

Special colors, custom markings available, consult Customer Service Center.

LED INFORMATION

SWITCHES WITH LED SUPPLIED: J86 OPTION:

Rectangular LEDs are supplied on 8060 Series pushbutton switches with J86 option. These LEDs are factory installed and are not replaceable. The following specifications apply:

OPTION CODE	COLOR	TYP. INTENSITY	TYP. FORWARD VOLTAGE	TYP. FORWARD CURRENT	MAX RATINGS AT 25°C AMBIENT TEMPERATURE		
					FORWARD VOLTAGE	CONTINUOUS FORWARD CURRENT	POWER DISSIPATION
6	Green	1.0 mcd	2.1 V	20 mA	2.5 V	50 mA	125 mW
3	Red*	0.5 mcd		10 mA		30 mA	75 mW
5	Yellow	4.0 mcd		20 mA		50 mA	125 mW



Process Information: Soldering to LED leads must be completed within 5 seconds at 500°F (260°C) maximum.

Caution: Circuit elements must limit forward current of LED to 50mA max. continuous.

* Extra-bright red LED available (typ. intensity 4.5 mcd), consult Customer Service Center.

LEDs are not supplied with J82 & J84 options. LED snaps into switch frame surrounding actuator and is wired externally.

Suggested LED for J82 & J84 options.
Dimensions for reference only.

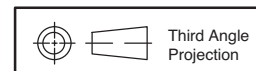

Dimensions are shown: Inches (mm)
Specifications and dimensions subject to change



29 Aug 18



Компания «ЭлектроПласт» предлагает заключение долгосрочных отношений при поставках импортных электронных компонентов на взаимовыгодных условиях!

Наши преимущества:

- Оперативные поставки широкого спектра электронных компонентов отечественного и импортного производства напрямую от производителей и с крупнейших мировых складов;
- Поставка более 17-ти миллионов наименований электронных компонентов;
- Поставка сложных, дефицитных, либо снятых с производства позиций;
- Оперативные сроки поставки под заказ (от 5 рабочих дней);
- Экспресс доставка в любую точку России;
- Техническая поддержка проекта, помощь в подборе аналогов, поставка прототипов;
- Система менеджмента качества сертифицирована по Международному стандарту ISO 9001;
- Лицензия ФСБ на осуществление работ с использованием сведений, составляющих государственную тайну;
- Поставка специализированных компонентов (Xilinx, Altera, Analog Devices, Intersil, Interpoint, Microsemi, Aeroflex, Peregrine, Syfer, Eurofarad, Texas Instrument, Miteq, Cobham, E2V, MA-COM, Hittite, Mini-Circuits, General Dynamics и др.);

Помимо этого, одним из направлений компании «ЭлектроПласт» является направление «Источники питания». Мы предлагаем Вам помощь Конструкторского отдела:

- Подбор оптимального решения, техническое обоснование при выборе компонента;
- Подбор аналогов;
- Консультации по применению компонента;
- Поставка образцов и прототипов;
- Техническая поддержка проекта;
- Защита от снятия компонента с производства.



Как с нами связаться

Телефон: 8 (812) 309 58 32 (многоканальный)

Факс: 8 (812) 320-02-42

Электронная почта: org@eplast1.ru

Адрес: 198099, г. Санкт-Петербург, ул. Калинина, дом 2, корпус 4, литера А.