



SMT flyback transformers

EFD series

Series/Type: B82802A
Ordering code:
Date: 2016-04-28

© EPCOS AG 2016. Reproduction, publication and dissemination of this publication, enclosures hereto and the information contained therein without EPCOS' prior express consent is prohibited.

EPCOS AG is a TDK Group Company.

Construction

- EFD type ferrite core
- 10 gull wing terminals

Features

- Low profile SMT package with high throughput power capability
- Industry standard footprints
- Compliant with JEDEC J-STD-020D
- MSL level 1
- RoHS compatible
- Custom variations available (on request)

Applications

- General purpose isolated DC/DC converters (up to 55 W)
- Power over Ethernet (PoE/12 W and PoE +/30 W), Powered Devices(PD) and Power Sourcing Equipment (PSD)

Marking

- Manufacturer, middle block of ordering code , date code, pin1 marker

Delivery mode and packing unit

- 44/56-mm blister tape, 330-mm Ø reel
- Packing unit: 300 pcs./ reel (EFD15)
- Packing unit: 160 pcs./ reel (EFD20)
- Packing unit: 80 pcs./ reel (EFD25)

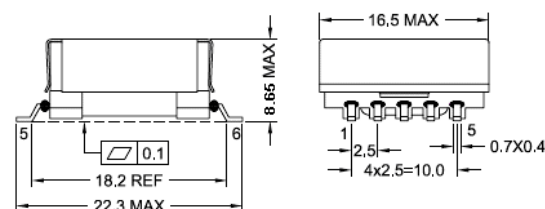
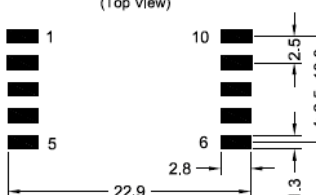
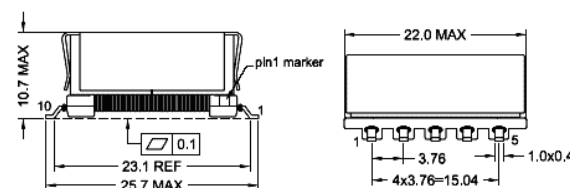
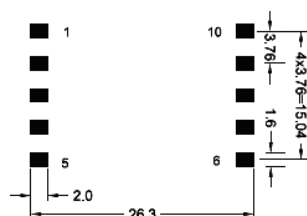
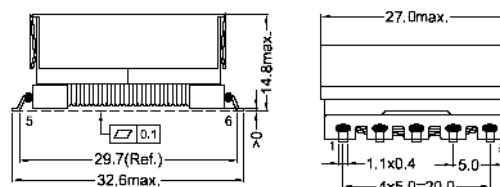
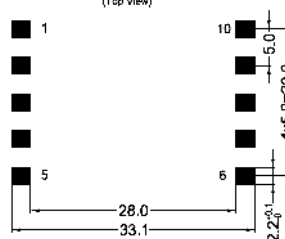
Dimensional drawing
■ EFD15

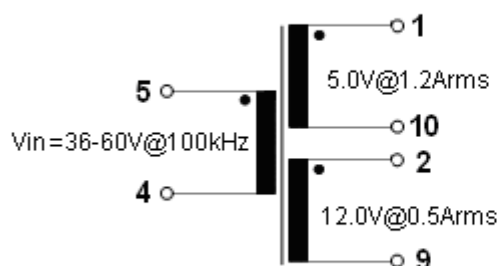
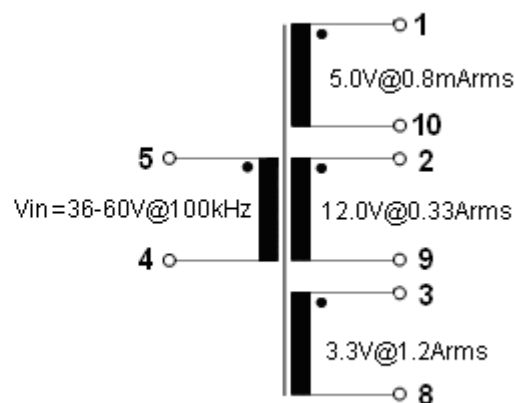
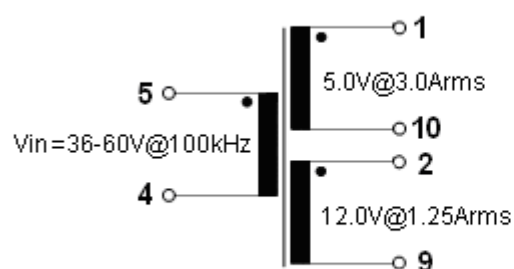
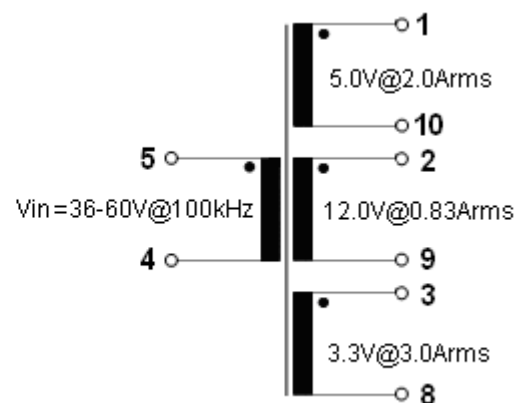
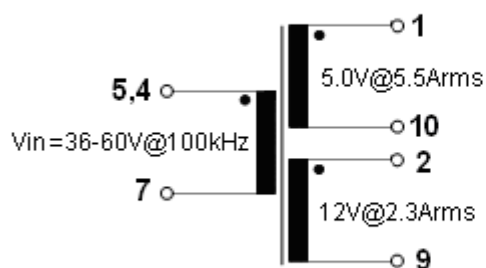
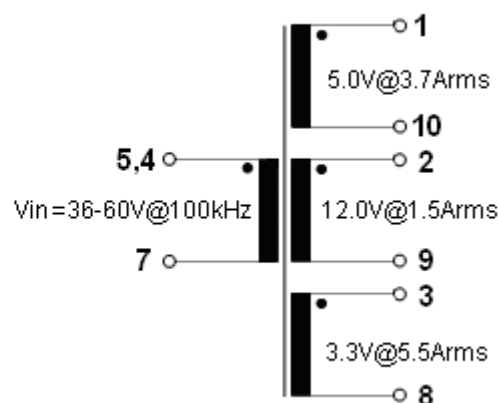
Recommended PCB Layout (Top View)

■ EFD20

Recommended PCB Layout (Top View)

■ EFD25

Recommended PCB layout (Top View)

Schematic :
■ Figure 1

Figure 2

■ Figure 3

Figure 4

■ Figure 5

Figure 6

SMT flyback transformers
EFD series
B82802A
Technical data and measuring conditions

Input voltage V_{in}	36 V DC ... 60 V DC
Test voltage V_{test}	Measured at 50 Hz, 1 s
Main inductance L	100 kHz, 100 mV, +25 °C
Inductance tolerance	±10% at +25 °C
DC current I_{DC}	With I_{DC} bias L_{drop} approx. 20%
Operating frequency f	100 kHz
DC resistance R_{max}	Measured at +25 °C, maximum values (specified per winding)
Solderability	≥99.9 Sn or Sn96.5Ag3.0Cu0.5: +(245± 5) °C, (3±0.3) s Wetting of soldering area: ≥95% (to IEC 60068-2-58)
Operating temperature range	-40 °C ... +125 °C

Characteristics and ordering codes

Ordering code	Core	Schematic	L μH	$L_{stray,max}$ μH	Turns ratio		DC resistance R_{max} (Ω)			
							Pri	Sec		
							V_{out1}	V_{out2}	V_{out3}	
B82802A0012A215	EFD15	Fig 1	100	3.0	(1-10):(2-9):(5-4)	1:2.25:6.5	0.03	0.19	0.45	-
B82802A0012A315	EFD15	Fig 2	100	3.0	(1-10):(2-9):(3-8):(5-4)	1:2.5:0.75:7.5	0.05	0.37	0.43	0.03
B82802A0030A220	EFD20	Fig 3	40	1.5	(1-10):(2-9):(5-4)	1:2.25:6.5	0.015	0.04	0.1	-
B82802A0030A320	EFD20	Fig 4	40	1.8	(1-10):(2-9):(3-8):(5-4)	1:2.25:0.75:6.5	0.018	0.04	0.1	0.01
B82802A0055A225	EFD25	Fig 5	22	1.5	(1-10):(2-9):(5,4-7)	1:2.5:7.5	0.0032	0.04	0.034	-
B82802A0055A325	EFD25	Fig 6	22	1.2	(1-10):(2-9):(3-8):(5,4-7)	1:2.33:0.66:6.67	0.015	0.04	0.05	0.0033

Ordering code	Core	Schematic	V_{test} V AC	Power W	V_{out1} V/A	V_{out2} V/A	V_{out3} V/A
B82802A0012A315	EFD15	Fig 2	800	12	5.0/0.8	3.3/1.2	12/0.33
B82802A0030A220	EFD20	Fig 3	1000	30	12/1.25	5.0/3.0	-
B82802A0030A320	EFD20	Fig 4	1000	30	5.0/2.0	3.3/3.0	12/0.83
B82802A0055A225	EFD25	Fig 5	1000	55	12/2.3	5.0/5.5	-
B82802A0055A325	EFD25	Fig 6	1000	55	5.0/3.7	3.3/5.5	12/1.5

SMT flyback transformers

EFD series

B82802A

Taping and Packing

Item	Core	Blister tape								Reel		
		W	T	A0	B0	P	K0	K1	F	Ø	W1	W2
DIM. (mm)	EFD15	44.0	0.5	16.6	22.3	24.0	8.6	8.1	40.4	330.0	44.0	48.0
	EFD20	44.0	0.6	21.7	26.6	32.0	11.6	10.6	40.4	330.0	44.0	48.0
	EFD25	56.0	0.6	26.2	33.0	44.0	14.6	13.8	52.4	330.0	56.0	60.0
Tolerance		±0.3	±0.05	±0.1	±0.1	±0.1	±0.1	±0.1	±0.1	±0.5	±2.0	±0.15

Blister tape

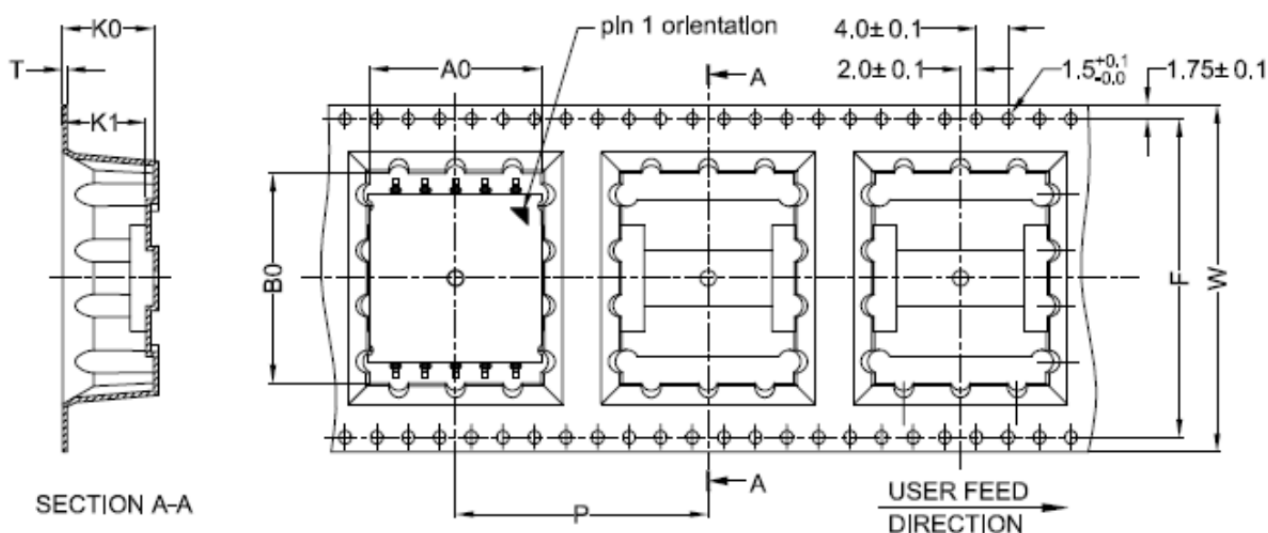

Reel

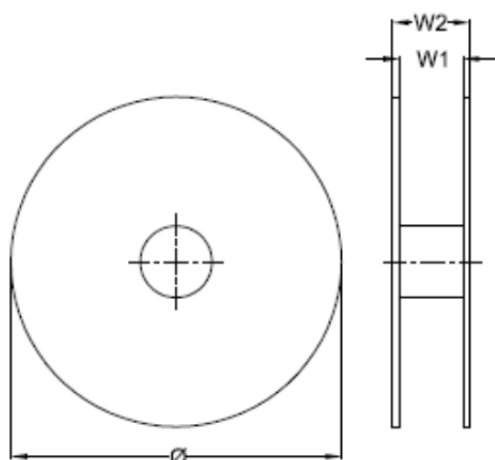

Cautions and warnings

- Please note the recommendations in our Inductors data book (latest edition) and in the data sheets.
 - Particular attention should be paid to the derating curves given there.
 - The soldering conditions should also be observed. Temperatures quoted in relation to wave soldering refer to the pin, not the housing.
- If the components are to be washed varnished it is necessary to check whether the washing varnish agent that is used has a negative effect on the wire insulation, any plastics that are used, or on glued joints. In particular, it is possible for washing varnish agent residues to have a negative effect in the long-term on wire insulation
Washing processes may damage the product due to the possible static or cyclic mechanical loads (e.g. ultrasonic cleaning). They may cause cracks to develop on the product and its parts, which might lead to reduced reliability or lifetime.
- The following points must be observed if the components are potted in customer applications:
 - Many potting materials shrink as they harden. They therefore exert a pressure on the plastic housing or core. This pressure can have a deleterious effect on electrical properties, and in extreme cases can damage the core or plastic housing mechanically.
 - It is necessary to check whether the potting material used attacks or destroys the wire insulation, plastics or glue.
 - The effect of the potting material can change the high-frequency behaviour of the components.
- Ferrites are sensitive to direct impact. This can cause the core material to flake, or lead to breakage of the core.
- Even for customer-specific products, conclusive validation of the component in the circuit can only be carried out by the customer.

Display of ordering codes for EPCOS products

The ordering code for one and the same EPCOS product can be represented differently in data sheets, data books, other publications, on the EPCOS website, or in order-related documents such as shipping notes, order confirmations and product labels. **The varying representations of the ordering codes are due to different processes employed and do not affect the specifications of the respective products.** Detailed information can be found on the Internet under www.epcos.com/orderingcodes

Important notes

The following applies to all products named in this publication:

1. Some parts of this publication contain **statements about the suitability of our products for certain areas of application**. These statements are based on our knowledge of typical requirements that are often placed on our products in the areas of application concerned. We nevertheless expressly point out **that such statements cannot be regarded as binding statements about the suitability of our products for a particular customer application**. As a rule we are either unfamiliar with individual customer applications or less familiar with them than the customers themselves. For these reasons, it is always ultimately incumbent on the customer to check and decide whether a product with the properties described in the product specification is suitable for use in a particular customer application.
2. We also point out that **in individual cases, a malfunction of electronic components or failure before the end of their usual service life cannot be completely ruled out in the current state of the art, even if they are operated as specified**. In customer applications requiring a very high level of operational safety and especially in customer applications in which the malfunction or failure of an electronic component could endanger human life or health (e.g. in accident prevention or life-saving systems), it must therefore be ensured by means of suitable design of the customer application or other action taken by the customer (e.g. installation of protective circuitry or redundancy) that no injury or damage is sustained by third parties in the event of malfunction or failure of an electronic component.
3. **The warnings, cautions and product-specific notes must be observed.**
4. In order to satisfy certain technical requirements, **some of the products described in this publication may contain substances subject to restrictions in certain jurisdictions (e.g. because they are classed as hazardous)**. Useful information on this will be found in our Material Data Sheets on the Internet (www.tdk-electronics.tdk.com/material). Should you have any more detailed questions, please contact our sales offices.
5. We constantly strive to improve our products. Consequently, **the products described in this publication may change from time to time**. The same is true of the corresponding product specifications. Please check therefore to what extent product descriptions and specifications contained in this publication are still applicable before or when you place an order.

We also **reserve the right to discontinue production and delivery of products**. Consequently, we cannot guarantee that all products named in this publication will always be available. The aforementioned does not apply in the case of individual agreements deviating from the foregoing for customer-specific products.
6. Unless otherwise agreed in individual contracts, **all orders are subject to our General Terms and Conditions of Supply**.
7. **Our manufacturing sites serving the automotive business apply the IATF 16949 standard**. The IATF certifications confirm our compliance with requirements regarding the quality management system in the automotive industry. Referring to customer requirements and customer specific requirements ("CSR") TDK always has and will continue to have the policy of respecting individual agreements. Even if IATF 16949 may appear to support the acceptance of unilateral requirements, we hereby like to emphasize that **only requirements mutually agreed upon can and will be implemented in our Quality Management System**. For clarification purposes we like to point out that obligations from IATF 16949 shall only become legally binding if individually agreed upon.
8. The trade names EPCOS, CeraCharge, CeraDiode, CeraLink, CeraPad, CeraPlas, CSMP, CTVS, DeltaCap, DigiSiMic, ExoCore, FilterCap, FormFit, LeaXield, MiniBlue, MiniCell, MKD, MKK, MotorCap, PCC, PhaseCap, PhaseCube, PhaseMod, PhiCap, PowerHap, PQSine, PQvar, SIFERRIT, SIFI, SIKOREL, SilverCap, SIMDAD, SiMic, SIMID, SineFormer, SIOV, ThermoFuse, WindCap are **trademarks registered or pending** in Europe and in other countries. Further information will be found on the Internet at www.tdk-electronics.tdk.com/trademarks.

Release 2018-10

Mouser Electronics

Authorized Distributor

Click to View Pricing, Inventory, Delivery & Lifecycle Information:

[EPCOS / TDK:](#)

[B82802A0030A220](#) [B82802A0030A320](#) [B82802A0055A325](#) [B82802A0012A315](#) [B82802A0012A215](#)
[B82802A0055A225](#)



Компания «ЭлектроПласт» предлагает заключение долгосрочных отношений при поставках импортных электронных компонентов на взаимовыгодных условиях!

Наши преимущества:

- Оперативные поставки широкого спектра электронных компонентов отечественного и импортного производства напрямую от производителей и с крупнейших мировых складов;
- Поставка более 17-ти миллионов наименований электронных компонентов;
- Поставка сложных, дефицитных, либо снятых с производства позиций;
- Оперативные сроки поставки под заказ (от 5 рабочих дней);
- Экспресс доставка в любую точку России;
- Техническая поддержка проекта, помощь в подборе аналогов, поставка прототипов;
- Система менеджмента качества сертифицирована по Международному стандарту ISO 9001;
- Лицензия ФСБ на осуществление работ с использованием сведений, составляющих государственную тайну;
- Поставка специализированных компонентов (Xilinx, Altera, Analog Devices, Intersil, Interpoint, Microsemi, Aeroflex, Peregrine, Syfer, Eurofarad, Texas Instrument, Miteq, Cobham, E2V, MA-COM, Hittite, Mini-Circuits, General Dynamics и др.);

Помимо этого, одним из направлений компании «ЭлектроПласт» является направление «Источники питания». Мы предлагаем Вам помощь Конструкторского отдела:

- Подбор оптимального решения, техническое обоснование при выборе компонента;
- Подбор аналогов;
- Консультации по применению компонента;
- Поставка образцов и прототипов;
- Техническая поддержка проекта;
- Защита от снятия компонента с производства.



Как с нами связаться

Телефон: 8 (812) 309 58 32 (многоканальный)

Факс: 8 (812) 320-02-42

Электронная почта: org@eplast1.ru

Адрес: 198099, г. Санкт-Петербург, ул. Калинина, дом 2, корпус 4, литера А.