

**40V COMPLEMENTARY MEDIUM POWER TRANSISTOR IN SOT26**

**Features**

- NPN + PNP combination
- $BV_{CEO} > 40$  (-40)V
- $BV_{ECO} > 6$  (-3)V
- $I_{CM} = 9$  (-9)A Peak Pulse Current
- $V_{CE(sat)} < 60$  (-90)mV @ 1A
- $R_{CE(sat)} = 38$  (58)m $\Omega$
- **Totally Lead-Free & Fully RoHS compliant (Notes 1 & 2)**
- **Halogen and Antimony Free. "Green" Device (Note 3)**
- **Qualified to AEC-Q101 Standards for High Reliability**

**Description**

Advanced process capability has been used to achieve this high performance device. Combining NPN and PNP transistors in the SOT26 package provides a compact solution for the intended applications.

**Mechanical Data**

- Case: SOT26
- Case Material: molded plastic, "Green" molding compound
- UL Flammability Classification Rating 94V-0
- Moisture Sensitivity: Level 1 per J-STD-020
- Terminals: Finish – Matte Tin Plated Leads, Solderable per MIL-STD-202, Method 208 **e3**
- Weight: 0.015 grams (approximate)

**Applications**

- MOSFET and IGBT gate driving
- Motor drive

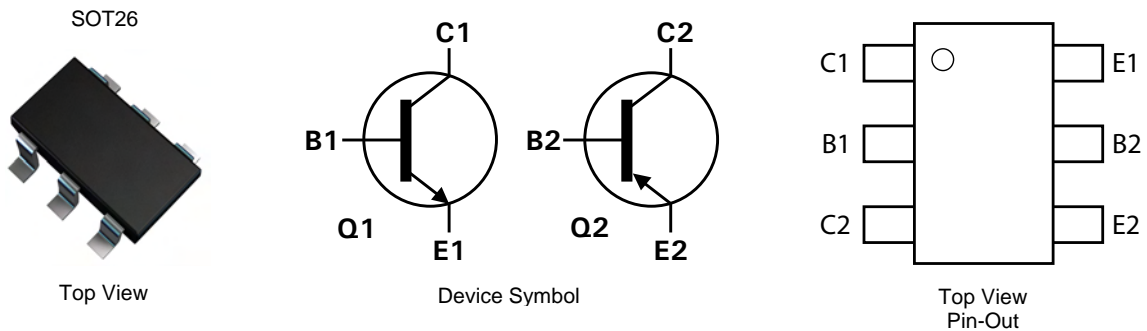

**Ordering Information** (Note 4)

Product	Marking	Reel size (inches)	Tape width (mm)	Quantity per reel
ZXTC2063E6TA	2063	7	8	3,000

- Notes:
1. No purposely added lead. Fully EU Directive 2002/95/EC (RoHS) & 2011/65/EU (RoHS 2) compliant.
  2. See <http://www.diodes.com/> for more information about Diodes Incorporated's definitions of Halogen and Antimony free, "Green" and Lead-Free.
  3. Halogen and Antimony free "Green" products are defined as those which contain <900ppm bromine, <900ppm chlorine (<1500ppm total Br + Cl) and <1000ppm antimony compounds.
  4. For packaging details, go to our website at <http://www.diodes.com>

**Marking Information**

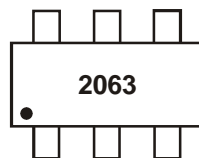

2063 = Product Type Marking Code

**Maximum Ratings – Q1 (NPN Transistor)** (@T<sub>A</sub> = +25°C, unless otherwise specified.)

Characteristic	Symbol	Value	Unit
Collector-Base Voltage	V <sub>CBO</sub>	130	V
Collector-Emitter Voltage	V <sub>CEO</sub>	40	V
Emitter-Collector Voltage (Reverse blocking)	V <sub>ECO</sub>	6	V
Emitter-Base Voltage	V <sub>EBO</sub>	7	V
Continuous Collector Current	I <sub>C</sub>	3.5	A
Peak Pulsed Collector Current	I <sub>CM</sub>	9	A
Base Current	I <sub>B</sub>	1	A

**Maximum Ratings – Q2 (PNP Transistor)** (@T<sub>A</sub> = +25°C, unless otherwise specified.)

Characteristic	Symbol	Value	Unit
Collector-Base Voltage	V <sub>CBO</sub>	-45	V
Collector-Emitter Voltage	V <sub>CEO</sub>	-40	V
Emitter-Collector Voltage (Reverse blocking)	V <sub>ECO</sub>	-3	V
Emitter-Base Voltage	V <sub>EBO</sub>	-7	V
Continuous Collector Current	I <sub>C</sub>	-3	A
Peak Pulsed Collector Current	I <sub>CM</sub>	-9	A
Base Current	I <sub>B</sub>	-1	A

**Thermal Characteristics** (@T<sub>A</sub> = +25°C, unless otherwise specified.)

Characteristic	Symbol	Value	Unit
Power Dissipation Linear Derating Factor	P <sub>D</sub>	(Notes 5 & 9)	0.7
		(Notes 6 & 9)	5.6
		(Notes 6 & 10)	0.9
		(Notes 7 & 9)	7.2
		(Notes 8 & 9)	1.1
		(Notes 8 & 9)	8.8
Thermal Resistance, Junction to Ambient	R <sub>θJA</sub>	(Notes 5 & 9)	1.1
		(Notes 6 & 9)	8.8
		(Notes 6 & 10)	1.1
		(Notes 7 & 9)	8.8
		(Notes 8 & 9)	1.7
Thermal Resistance, Junction to Lead	R <sub>θJL</sub>	13.6	°C/W
Operating and Storage Temperature Range	T <sub>J</sub> , T <sub>STG</sub>	-55 to +150	°C

- Notes:
- For a device surface mounted on 15mm x 15mm FR4 PCB with high coverage of single sided 1oz copper, in still air conditions; the device is measured when operating in a steady-state condition.
  - Same as note (5), except the device is surface mounted on 25mm x 25mm 1oz copper.
  - Same as note (5), except the device is surface mounted on 50mm x 50mm 2oz copper.
  - Same as note (7), except the device is measured at t < 5 seconds.
  - For device with one active die, both collectors attached to a common heatsink.
  - For device with two active dice running at equal power, split heatsink 50% to each collector.
  - Thermal resistance from junction to solder-point (at the end of the collector lead).

**Thermal Characteristics and Derating Information**

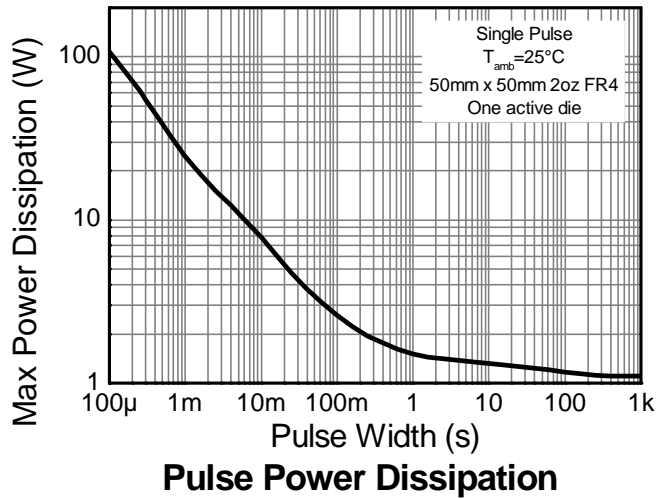
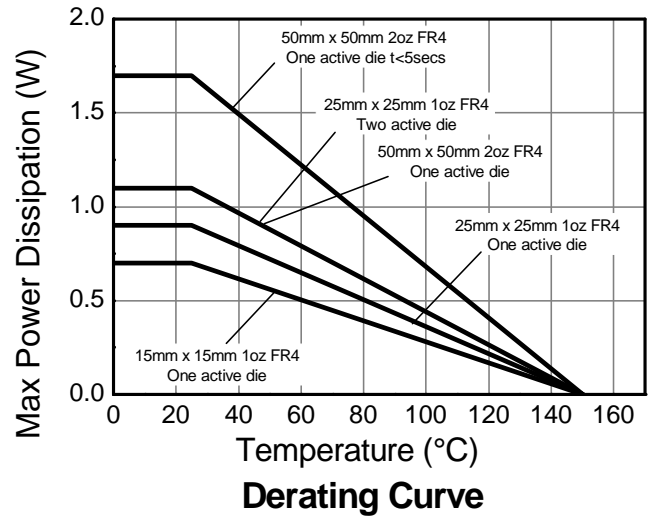
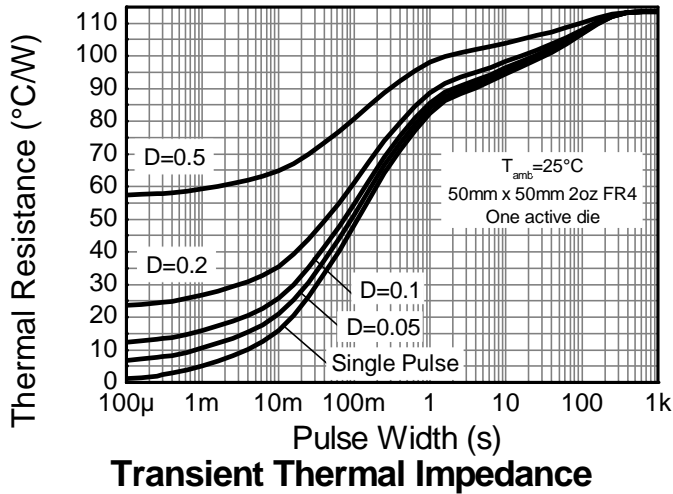
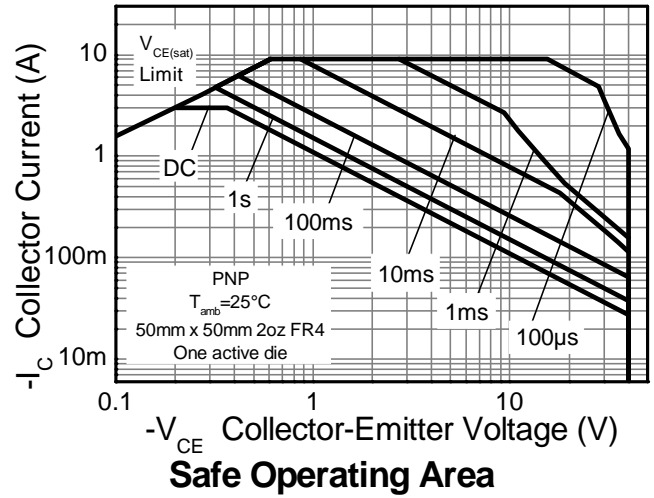
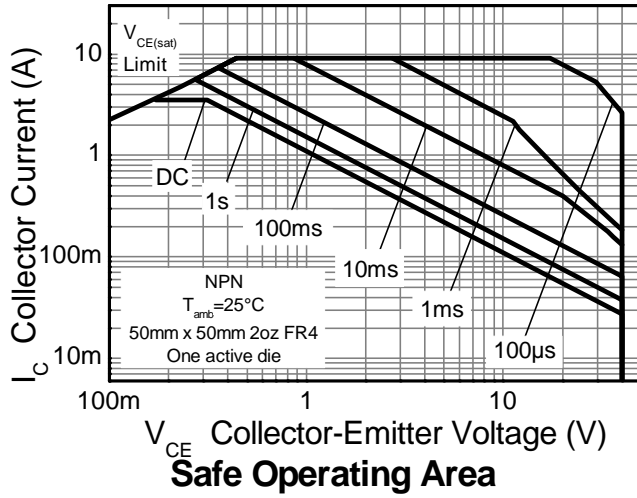

**Electrical Characteristics – Q1 (NPN Transistor)** (@T<sub>A</sub> = +25°C, unless otherwise specified.)

Characteristic	Symbol	Min	Typ	Max	Unit	Test Condition
<b>OFF CHARACTERISTICS</b>						
Collector-Base Breakdown Voltage	BV <sub>CBO</sub>	130	170	—	V	I <sub>C</sub> = 100μA, I <sub>E</sub> = 0
Collector-Emitter Breakdown Voltage (Note 12)	BV <sub>CEO</sub>	40	63	—	V	I <sub>C</sub> = 10mA, I <sub>B</sub> = 0
Emitter-Base Breakdown Voltage	BV <sub>EBO</sub>	7	8.3	—	V	I <sub>E</sub> = 100μA, I <sub>C</sub> = 0
Emitter-collector breakdown voltage (reverse blocking)	BV <sub>ECX</sub>	6	7.4	—	V	I <sub>E</sub> = 100μA, R <sub>BC</sub> < 1kΩ or 0.25V > V <sub>BC</sub> > -0.25V
Emitter-collector breakdown voltage (base open)	BV <sub>ECO</sub>	6	7.4	—	V	I <sub>E</sub> = 100μA
Collector Cutoff Current	I <sub>CBO</sub>	—	<1	50	nA	V <sub>CB</sub> = 100V
Collector Cutoff Current	I <sub>EBO</sub>	—	<1	50	nA	V <sub>CB</sub> = 100V, T <sub>A</sub> = +100°C
Collector Cutoff Current	I <sub>EBO</sub>	—	<1	50	nA	V <sub>EB</sub> = 5.6V
<b>ON CHARACTERISTICS (Note 12)</b>						
DC Current Gain	h <sub>FE</sub>	300 280 40	450 400 60	900	—	I <sub>C</sub> = 10mA, V <sub>CE</sub> = 2V I <sub>C</sub> = 1.0A, V <sub>CE</sub> = 2V I <sub>C</sub> = 3.5A, V <sub>CE</sub> = 2V
Collector-Emitter Saturation Voltage	V <sub>CE(sat)</sub>	—	50 85 150 135	60 110 220 195	mV	I <sub>C</sub> = 1.0A, I <sub>B</sub> = 100mA I <sub>C</sub> = 1.0A, I <sub>B</sub> = 20mA I <sub>C</sub> = 2.0A, I <sub>B</sub> = 40mA I <sub>C</sub> = 3.5A, I <sub>B</sub> = 350mA
Base-Emitter Saturation Voltage	V <sub>BE(sat)</sub>	—	960	1050	mV	I <sub>C</sub> = 3.5A, I <sub>B</sub> = 350mA
Base-Emitter Turn-On Voltage	V <sub>BE(on)</sub>	—	860	950	mV	I <sub>C</sub> = 3.5A, V <sub>CE</sub> = 2V
<b>SMALL SIGNAL CHARACTERISTICS</b>						
Output Capacitance	C <sub>obo</sub>	—	12	20	pF	V <sub>CB</sub> = 10V, f = 1.0MHz
Current Gain-Bandwidth Product	f <sub>T</sub>	—	190	—	MHz	V <sub>CE</sub> = 10V, I <sub>C</sub> = 50mA, f = 100MHz
Delay Time	t <sub>d</sub>	—	64	—	ns	V <sub>CC</sub> = 10V, I <sub>C</sub> = 1A, I <sub>B1</sub> = I <sub>B2</sub> = 10mA
Rise Time	t <sub>r</sub>	—	108	—	ns	
Storage Time	t <sub>s</sub>	—	428	—	ns	
Fall Time	t <sub>f</sub>	—	130	—	ns	

Notes: 12. Measured under pulsed conditions. Pulse width ≤ 300μs. Duty cycle ≤ 2%.

**Electrical Characteristics – Q2 (PNP Transistor)** (@T<sub>A</sub> = +25°C, unless otherwise specified.)

Characteristic	Symbol	Min	Typ	Max	Unit	Test Condition
<b>OFF CHARACTERISTICS</b>						
Collector-Base Breakdown Voltage	BV <sub>CB0</sub>	-45	-80	—	V	I <sub>C</sub> = -100μA, I <sub>E</sub> = 0
Collector-Emitter Breakdown Voltage (Note 12)	BV <sub>CEO</sub>	-40	-65	—	V	I <sub>C</sub> = -10mA, I <sub>B</sub> = 0
Emitter-Base Breakdown Voltage	BV <sub>EBO</sub>	-7	-8.3	—	V	I <sub>E</sub> = -100μA, I <sub>C</sub> = 0
Emitter-collector breakdown voltage (reverse blocking)	BV <sub>ECX</sub>	-6	-7.4	—	V	-I <sub>E</sub> = 100μA, R <sub>BC</sub> < 1kΩ or 0.25V < V <sub>BC</sub> < -0.25V
Emitter-collector breakdown voltage (base open)	BV <sub>EEO</sub>	-3	-8.7	—	V	I <sub>E</sub> = -100μA
Collector Cutoff Current	I <sub>CBO</sub>	—	<1	-50	nA	V <sub>CB</sub> = -36V
Collector Cutoff Current	I <sub>EBO</sub>	—	<1	-50	nA	V <sub>CB</sub> = -36V, T <sub>A</sub> = +100°C
Collector Cutoff Current	I <sub>EBO</sub>	—	<1	-50	nA	V <sub>EB</sub> = -5.6V
<b>ON CHARACTERISTICS (Note 12)</b>						
DC Current Gain	h <sub>FE</sub>	300 200 20	450 280 50	900 — —	—	I <sub>C</sub> = -10mA, V <sub>CE</sub> = -2V I <sub>C</sub> = -1.0A, V <sub>CE</sub> = -2V I <sub>C</sub> = -3.0A, V <sub>CE</sub> = -2V
Collector-Emitter Saturation Voltage	V <sub>CE(sat)</sub>	—	-70 -195 -175	-90 -290 -260	mV	I <sub>C</sub> = -1.0A, I <sub>B</sub> = -100mA I <sub>C</sub> = -1.0A, I <sub>B</sub> = -20mA I <sub>C</sub> = -3.0A, I <sub>B</sub> = -300mA
Base-Emitter Saturation Voltage	V <sub>BE(sat)</sub>	—	-935	-1000	mV	I <sub>C</sub> = -3.0A, I <sub>B</sub> = -300mA
Base-Emitter Turn-On Voltage	V <sub>BE(on)</sub>	—	-855	-950	mV	I <sub>C</sub> = -3.0A, V <sub>CE</sub> = -2V
<b>SMALL SIGNAL CHARACTERISTICS</b>						
Output Capacitance	C <sub>obo</sub>	—	17	25	pF	V <sub>CB</sub> = -10V, f = 1.0MHz
Current Gain-Bandwidth Product	f <sub>T</sub>	—	270	—	MHz	V <sub>CE</sub> = -10V, I <sub>C</sub> = -50mA, f = 100MHz
Delay Time	t <sub>d</sub>	—	57	—	ns	V <sub>CC</sub> = -10V, I <sub>C</sub> = -1A, I <sub>B1</sub> = I <sub>B2</sub> = -10mA
Rise Time	t <sub>r</sub>	—	69	—	ns	
Storage Time	t <sub>s</sub>	—	154	—	ns	
Fall Time	t <sub>f</sub>	—	60	—	ns	

Notes: 12. Measured under pulsed conditions. Pulse width ≤ 300μs. Duty cycle ≤ 2%.

**Typical Electrical Characteristics – Q1 (NPN Transistor)** (@ $T_A = +25^\circ\text{C}$ , unless otherwise specified.)

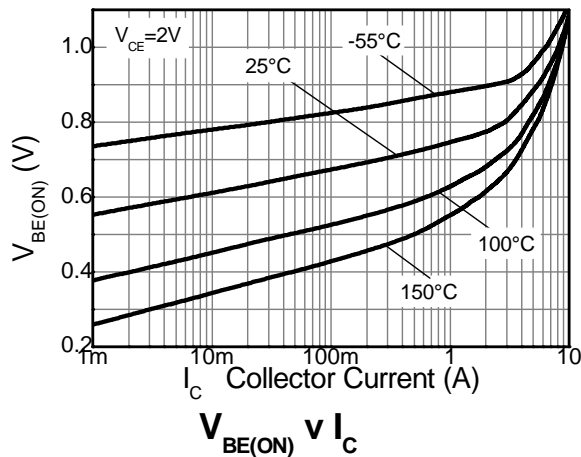
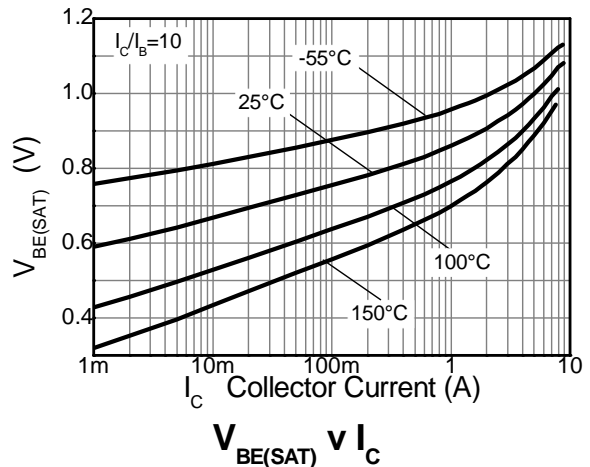
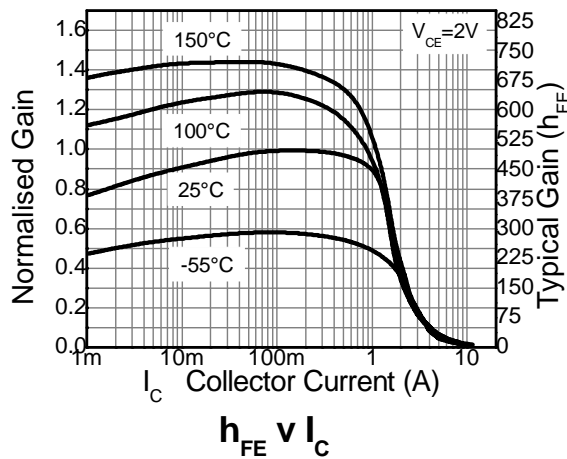
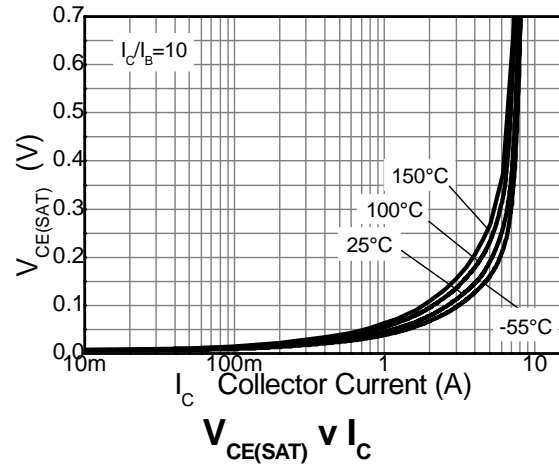
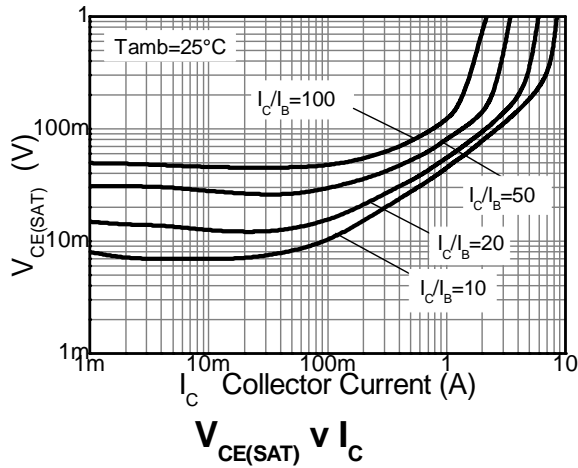

**Typical Electrical Characteristics – Q2 (PNP Transistor)** (@T<sub>A</sub> = +25°C, unless otherwise specified.)

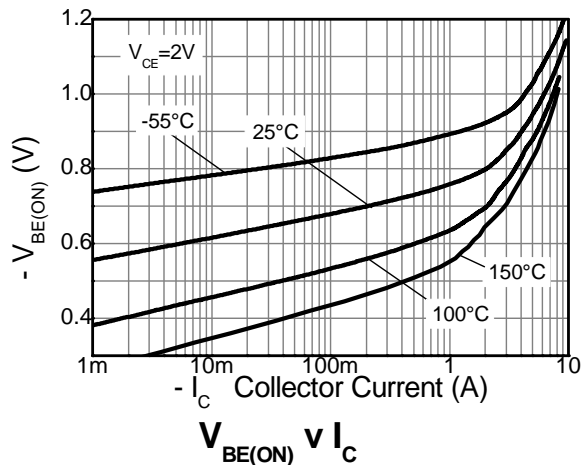
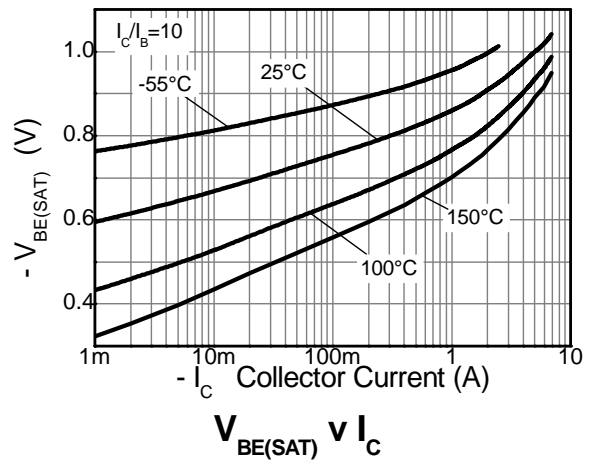
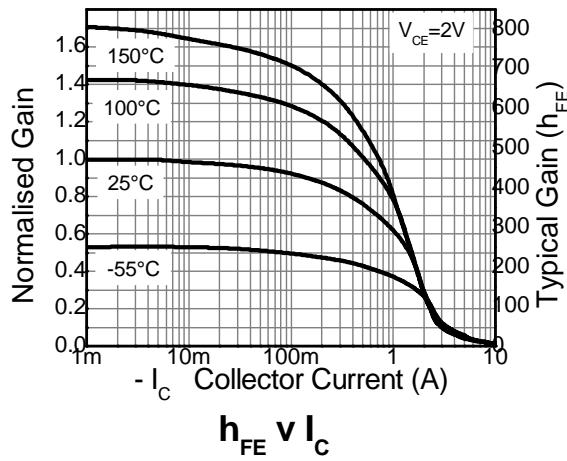
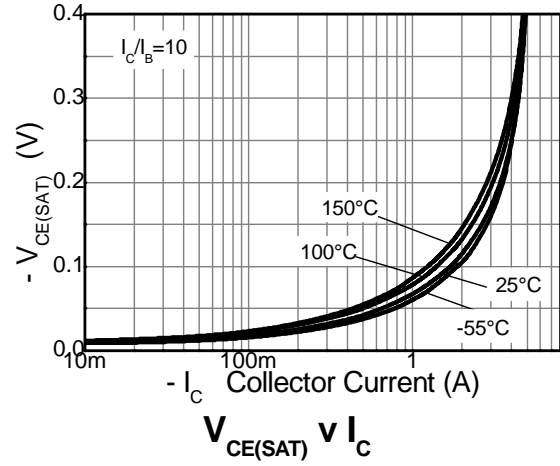
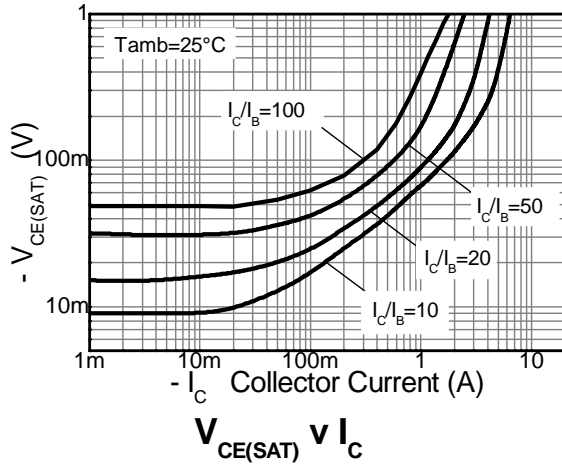

## Package Outline Dimensions

Please see AP02002 at <http://www.diodes.com/datasheets/ap02002.pdf> for latest version.

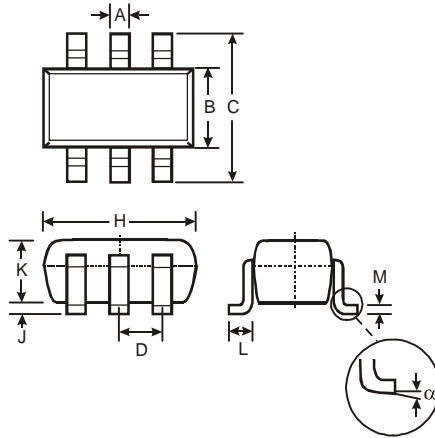

SOT26			
Dim	Min	Max	Typ
A	0.35	0.50	0.38
B	1.50	1.70	1.60
C	2.70	3.00	2.80
D	—	—	0.95
H	2.90	3.10	3.00
J	0.013	0.10	0.05
K	1.00	1.30	1.10
L	0.35	0.55	0.40
M	0.10	0.20	0.15
α	0°	8°	—
All Dimensions in mm			

## Suggested Pad Layout

Please see AP02001 at <http://www.diodes.com/datasheets/ap02001.pdf> for the latest version.

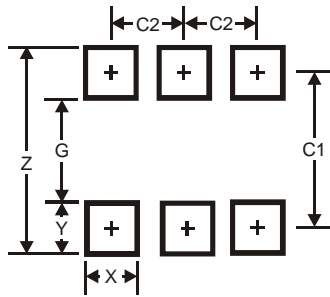

Dimensions	Value (in mm)
Z	3.20
G	1.60
X	0.55
Y	0.80
C1	2.40
C2	0.95



**IMPORTANT NOTICE**

DIODES INCORPORATED MAKES NO WARRANTY OF ANY KIND, EXPRESS OR IMPLIED, WITH REGARDS TO THIS DOCUMENT, INCLUDING, BUT NOT LIMITED TO, THE IMPLIED WARRANTIES OF MERCHANTABILITY AND FITNESS FOR A PARTICULAR PURPOSE (AND THEIR EQUIVALENTS UNDER THE LAWS OF ANY JURISDICTION).

Diodes Incorporated and its subsidiaries reserve the right to make modifications, enhancements, improvements, corrections or other changes without further notice to this document and any product described herein. Diodes Incorporated does not assume any liability arising out of the application or use of this document or any product described herein; neither does Diodes Incorporated convey any license under its patent or trademark rights, nor the rights of others. Any Customer or user of this document or products described herein in such applications shall assume all risks of such use and will agree to hold Diodes Incorporated and all the companies whose products are represented on Diodes Incorporated website, harmless against all damages.

Diodes Incorporated does not warrant or accept any liability whatsoever in respect of any products purchased through unauthorized sales channel. Should Customers purchase or use Diodes Incorporated products for any unintended or unauthorized application, Customers shall indemnify and hold Diodes Incorporated and its representatives harmless against all claims, damages, expenses, and attorney fees arising out of, directly or indirectly, any claim of personal injury or death associated with such unintended or unauthorized application.

Products described herein may be covered by one or more United States, international or foreign patents pending. Product names and markings noted herein may also be covered by one or more United States, international or foreign trademarks.

This document is written in English but may be translated into multiple languages for reference. Only the English version of this document is the final and determinative format released by Diodes Incorporated.

**LIFE SUPPORT**

Diodes Incorporated products are specifically not authorized for use as critical components in life support devices or systems without the express written approval of the Chief Executive Officer of Diodes Incorporated. As used herein:

A. Life support devices or systems are devices or systems which:

1. are intended to implant into the body, or
2. support or sustain life and whose failure to perform when properly used in accordance with instructions for use provided in the labeling can be reasonably expected to result in significant injury to the user.

B. A critical component is any component in a life support device or system whose failure to perform can be reasonably expected to cause the failure of the life support device or to affect its safety or effectiveness.

Customers represent that they have all necessary expertise in the safety and regulatory ramifications of their life support devices or systems, and acknowledge and agree that they are solely responsible for all legal, regulatory and safety-related requirements concerning their products and any use of Diodes Incorporated products in such safety-critical, life support devices or systems, notwithstanding any devices- or systems-related information or support that may be provided by Diodes Incorporated. Further, Customers must fully indemnify Diodes Incorporated and its representatives against any damages arising out of the use of Diodes Incorporated products in such safety-critical, life support devices or systems.

Copyright © 2012, Diodes Incorporated

[www.diodes.com](http://www.diodes.com)



Компания «ЭлектроПласт» предлагает заключение долгосрочных отношений при поставках импортных электронных компонентов на взаимовыгодных условиях!

Наши преимущества:

- Оперативные поставки широкого спектра электронных компонентов отечественного и импортного производства напрямую от производителей и с крупнейших мировых складов;
- Поставка более 17-ти миллионов наименований электронных компонентов;
- Поставка сложных, дефицитных, либо снятых с производства позиций;
- Оперативные сроки поставки под заказ (от 5 рабочих дней);
- Экспресс доставка в любую точку России;
- Техническая поддержка проекта, помощь в подборе аналогов, поставка прототипов;
- Система менеджмента качества сертифицирована по Международному стандарту ISO 9001;
- Лицензия ФСБ на осуществление работ с использованием сведений, составляющих государственную тайну;
- Поставка специализированных компонентов (Xilinx, Altera, Analog Devices, Intersil, Interpoint, Microsemi, Aeroflex, Peregrine, Syfer, Eurofarad, Texas Instrument, Miteq, Cobham, E2V, MA-COM, Hittite, Mini-Circuits, General Dynamics и др.);

Помимо этого, одним из направлений компании «ЭлектроПласт» является направление «Источники питания». Мы предлагаем Вам помощь Конструкторского отдела:

- Подбор оптимального решения, техническое обоснование при выборе компонента;
- Подбор аналогов;
- Консультации по применению компонента;
- Поставка образцов и прототипов;
- Техническая поддержка проекта;
- Защита от снятия компонента с производства.



#### Как с нами связаться

**Телефон:** 8 (812) 309 58 32 (многоканальный)

**Факс:** 8 (812) 320-02-42

**Электронная почта:** [org@eplast1.ru](mailto:org@eplast1.ru)

**Адрес:** 198099, г. Санкт-Петербург, ул. Калинина, дом 2, корпус 4, литера А.