

THIS DRAWING IS UNPUBLISHED. RELEASED FOR PUBLICATION 2006
 © COPYRIGHT 2006 BY TYCO ELECTRONICS CORPORATION. ALL INTERNATIONAL RIGHTS RESERVED.

LOC	DIST	REVISIONS					
J		P	LTR	DESCRIPTION	DATE	DWN	APVD
		C		REVISED PER ECR-10-017569	26AUG2010	HMR	T.M

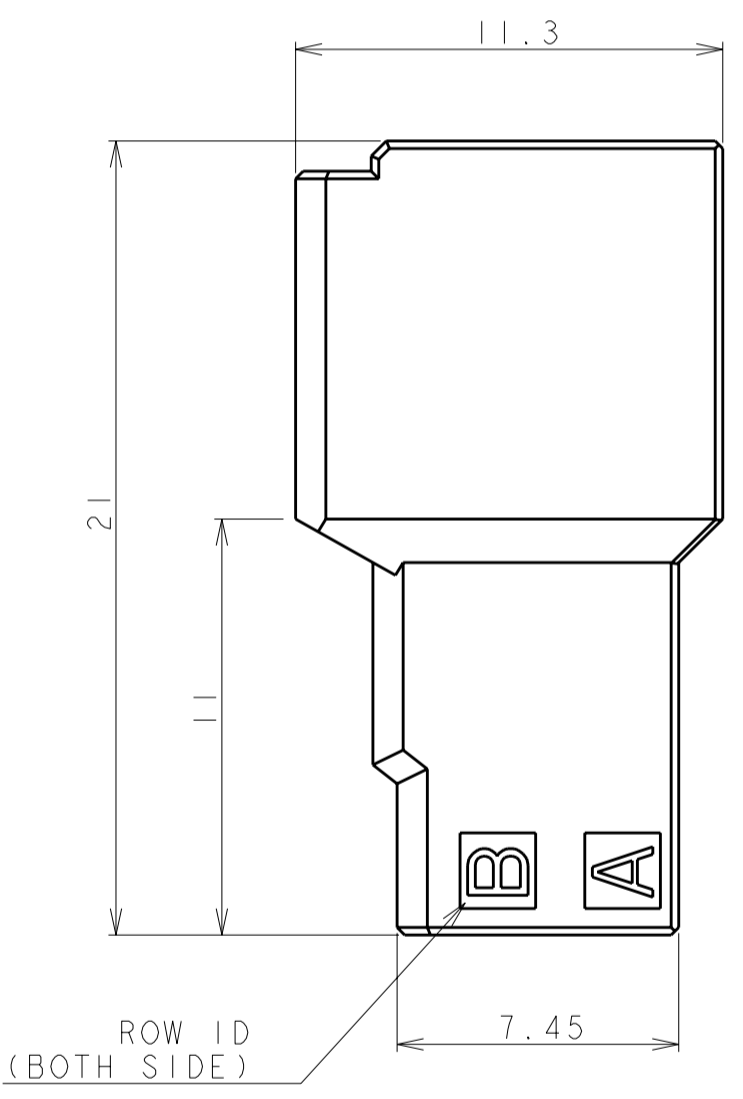
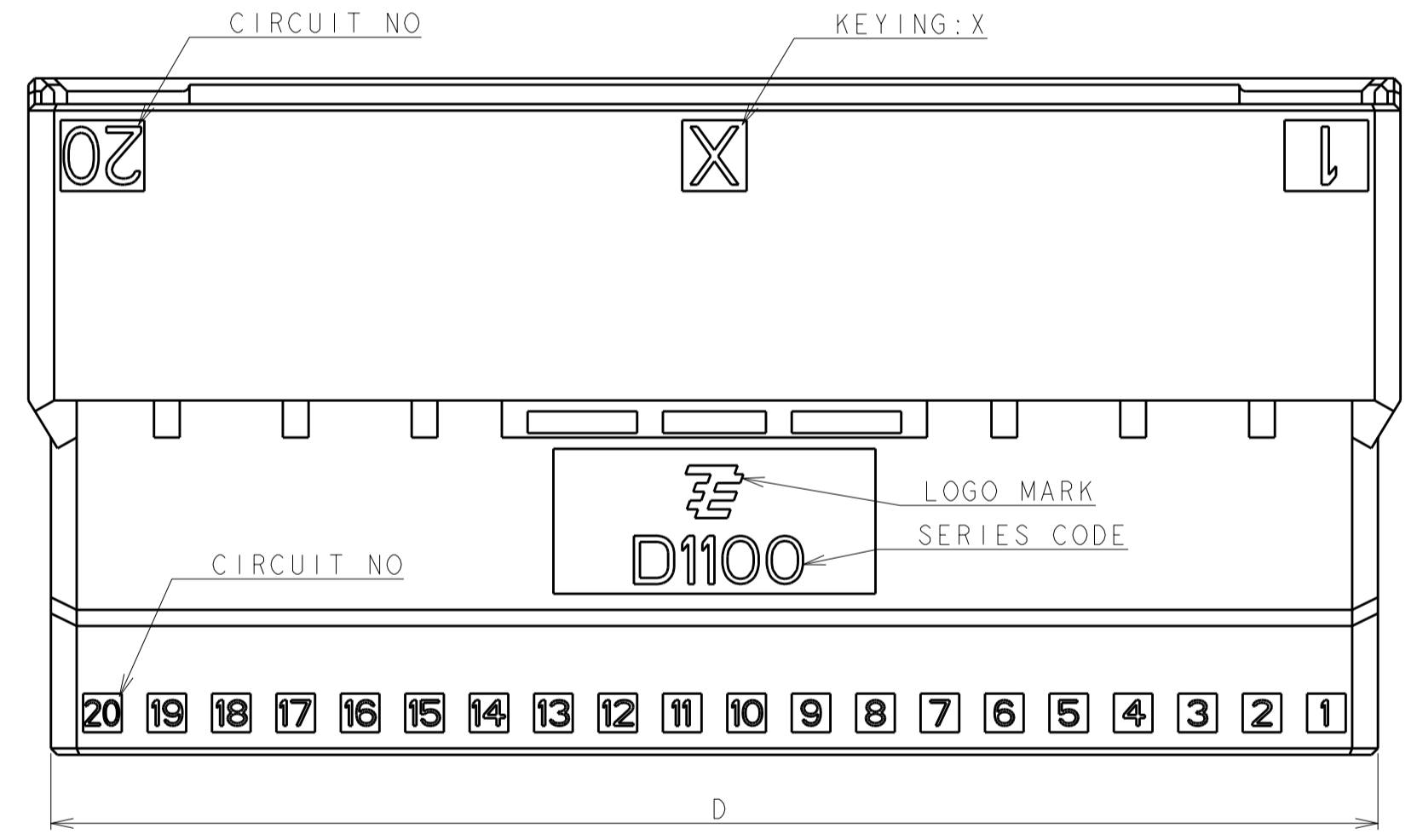
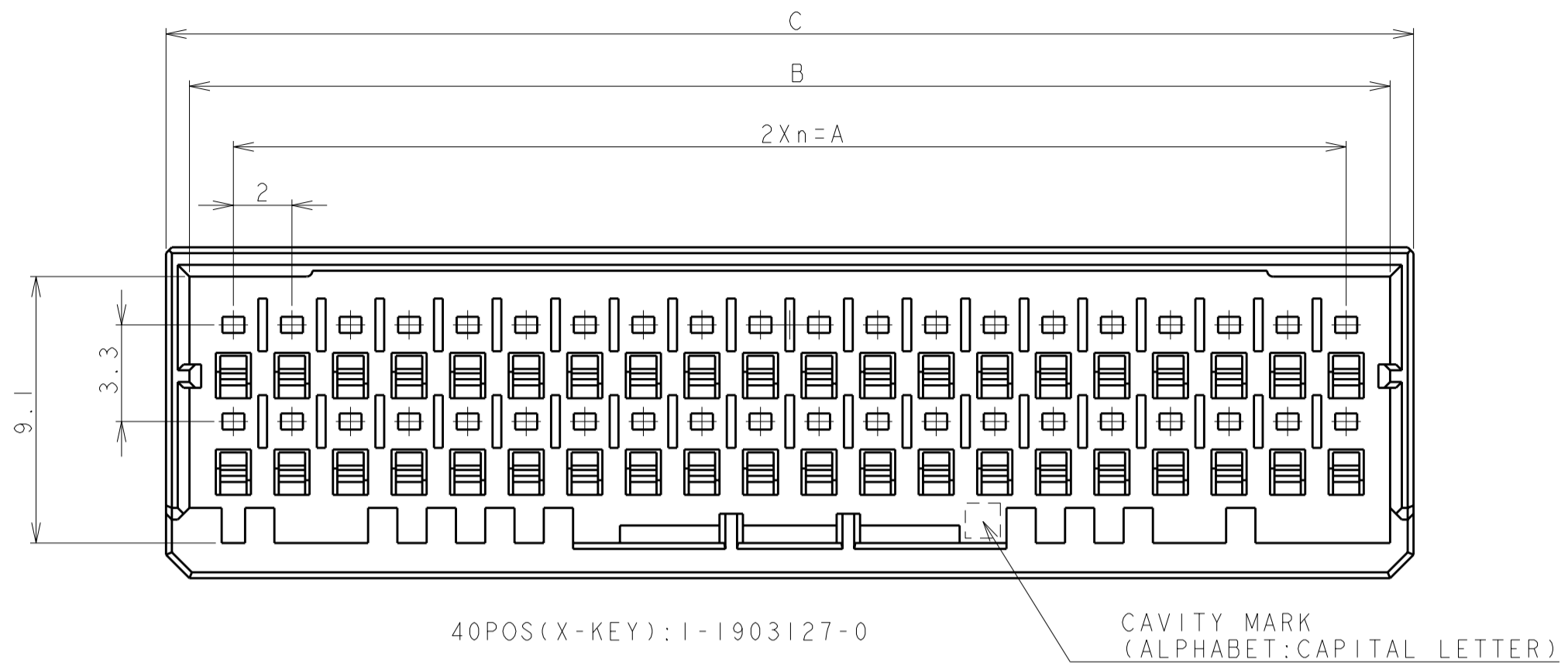

1. MATERIAL: GLASS FILED THERMO PLASTIC POLYESTER(94V-0), COLOR: BLACK
 2. THE SHAPE, SIZE AND POSITION OF THE CHARACTER SHOW THE OUTLINE. THEY DON'T SHOW DETAILS.

1. 材料: ガラス入り熱可塑性ポリエステル樹脂(94V-0), 色: 黒
 2. 文字の形状、大きさ、および位置については、大略を示すものであり、詳細を示すものではありません。

AS SHOWN 40POS : 1-1903127-0

POS	KEY	n	A	B	C	D	PART NO
40	X	19	38.0	41.0	42.6	41.2	1-1903127-0
34	X	16	32.0	35.0	36.6	35.2	1-1903127-7
32	X	15	30.0	33.0	34.6	33.2	1-1903127-6
28	X	13	26.0	29.0	30.6	29.2	1-1903127-4
26	X	12	24.0	27.0	28.6	27.2	1-1903127-3
22	X	10	20.0	23.0	24.6	23.2	1-1903127-1

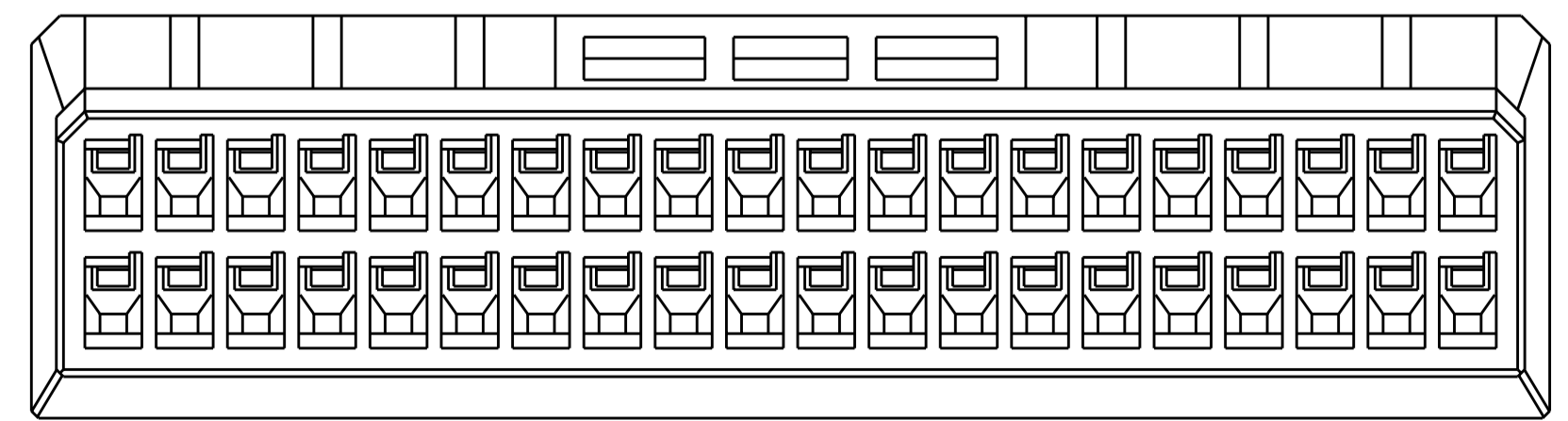

THIS DRAWING IS A CONTROLLED DOCUMENT FOR TYCO ELECTRONICS CORPORATION IT IS SUBJECT TO CHANGE AND THE CONTROLLING ENGINEERING ORGANIZATION SHOULD BE CONTACTED FOR THE LATEST REVISION.

DWN: M. MAEBASHI 11APR2006
 CHK: T. KUDO 11APR2006
 APVD: D. MITSUGI 11APR2006

Tyco Electronics Corporation
 Kawasaki, Japan

NAME: DYNAMIC D1100D 2.0mm PITCH TAB HSG, FREE HANGING TYPE 22-40 POS

PRODUCT SPEC: 108-78268, 78298
 APPLICATION SPEC: 114-5377

SIZE: A2 CAGE CODE: 0779 DRAWING NO: 1903127
 SCALE: 5:1 SHEET 1 OF 3 REV C

DIMENSIONS: 単位: 概 mm
 TOLERANCES UNLESS OTHERWISE SPECIFIED:
 一般公差 ±0.3, ±3°
 0-PLC ±
 1-PLC ±
 2-PLC ±
 3-PLC ±
 4-PLC ±
 ANGLES ±
 FINISH 仕上

MATERIAL 材料

WEIGHT

CUSTOMER DRAWING

THIS DRAWING IS UNPUBLISHED. RELEASED FOR PUBLICATION 2006
 © COPYRIGHT 2006 BY TYCO ELECTRONICS CORPORATION. ALL INTERNATIONAL RIGHTS RESERVED.

LOC		DIST		REVISIONS			
P	LTR	DESCRIPTION	DATE	DWN	APVD		
-		SEE SHEET 1					

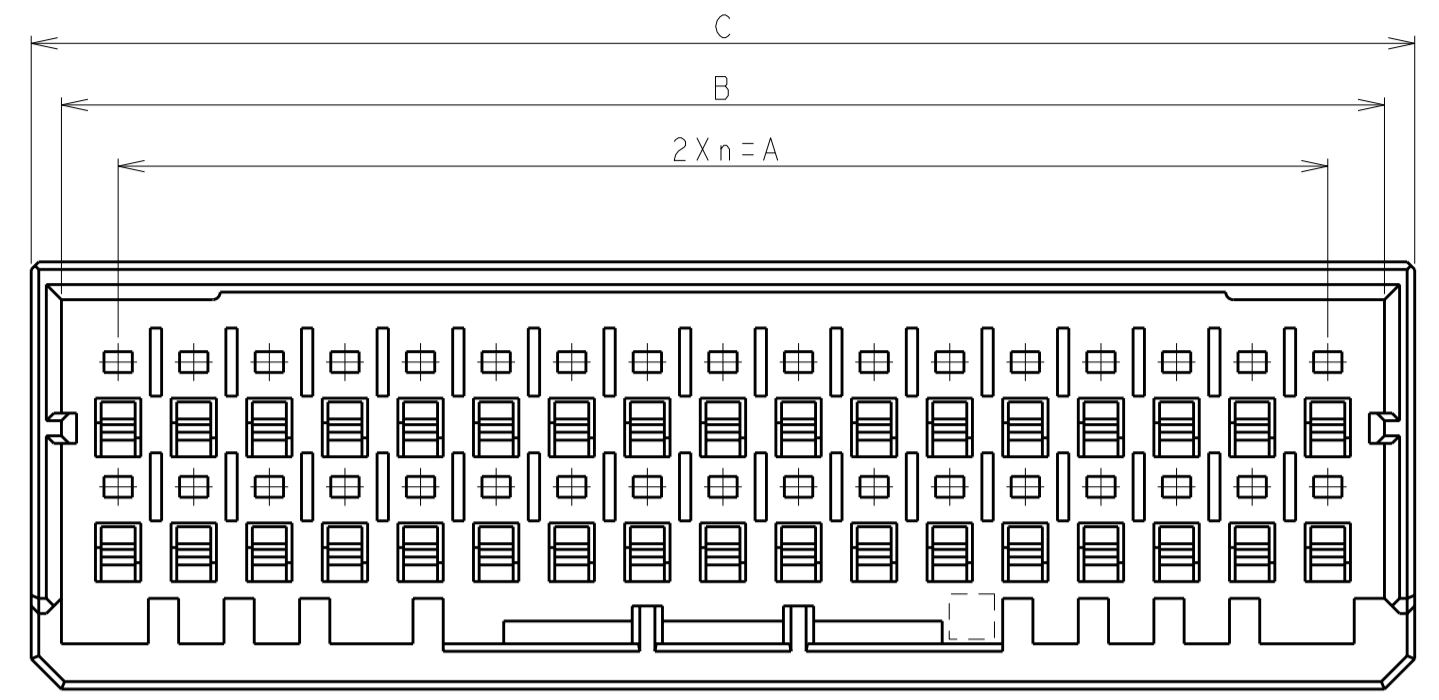

34POS(X-KEY): I-1903127-7

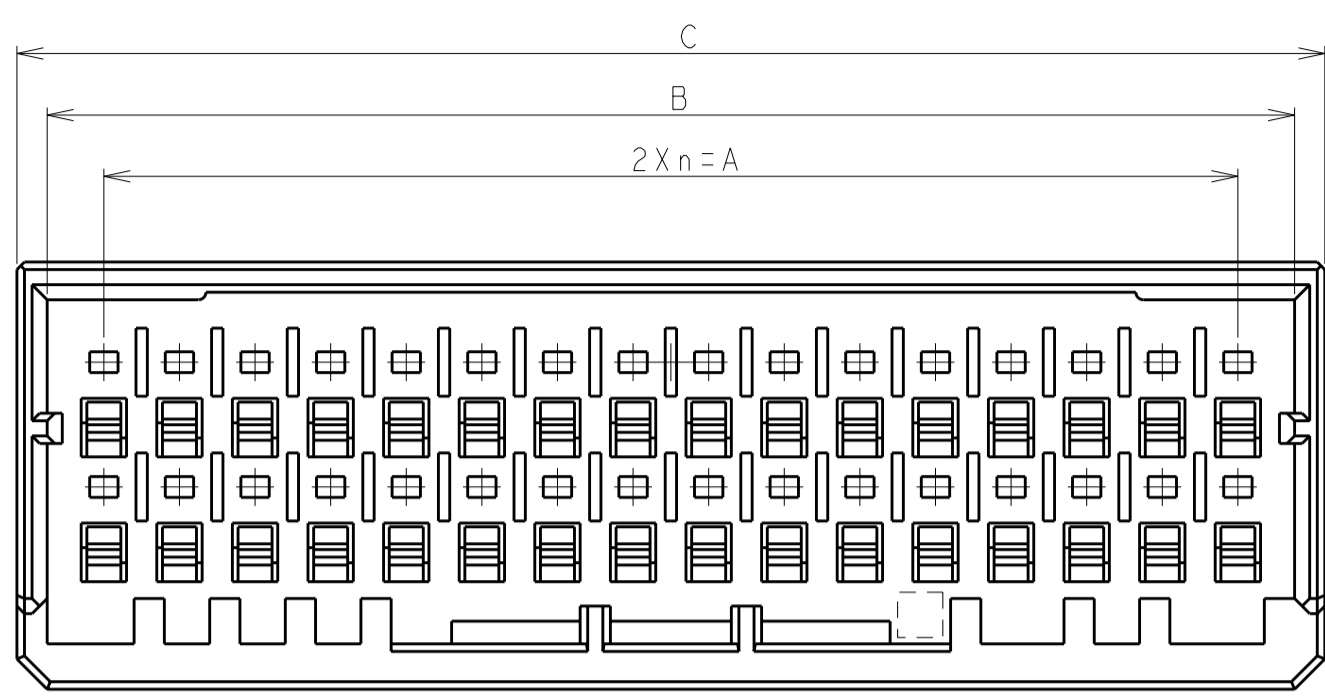

32POS(X-KEY): I-1903127-6

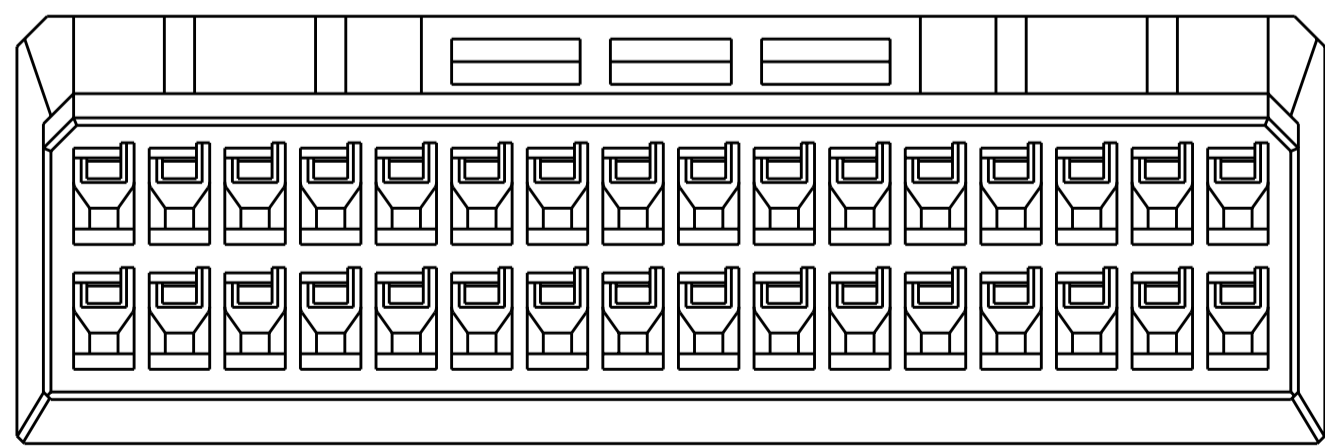
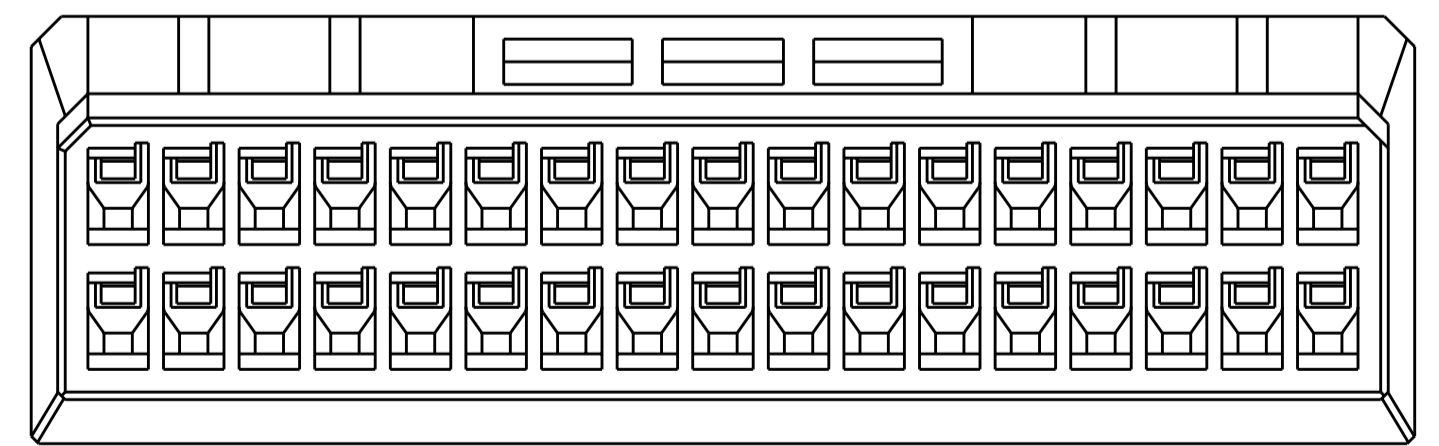
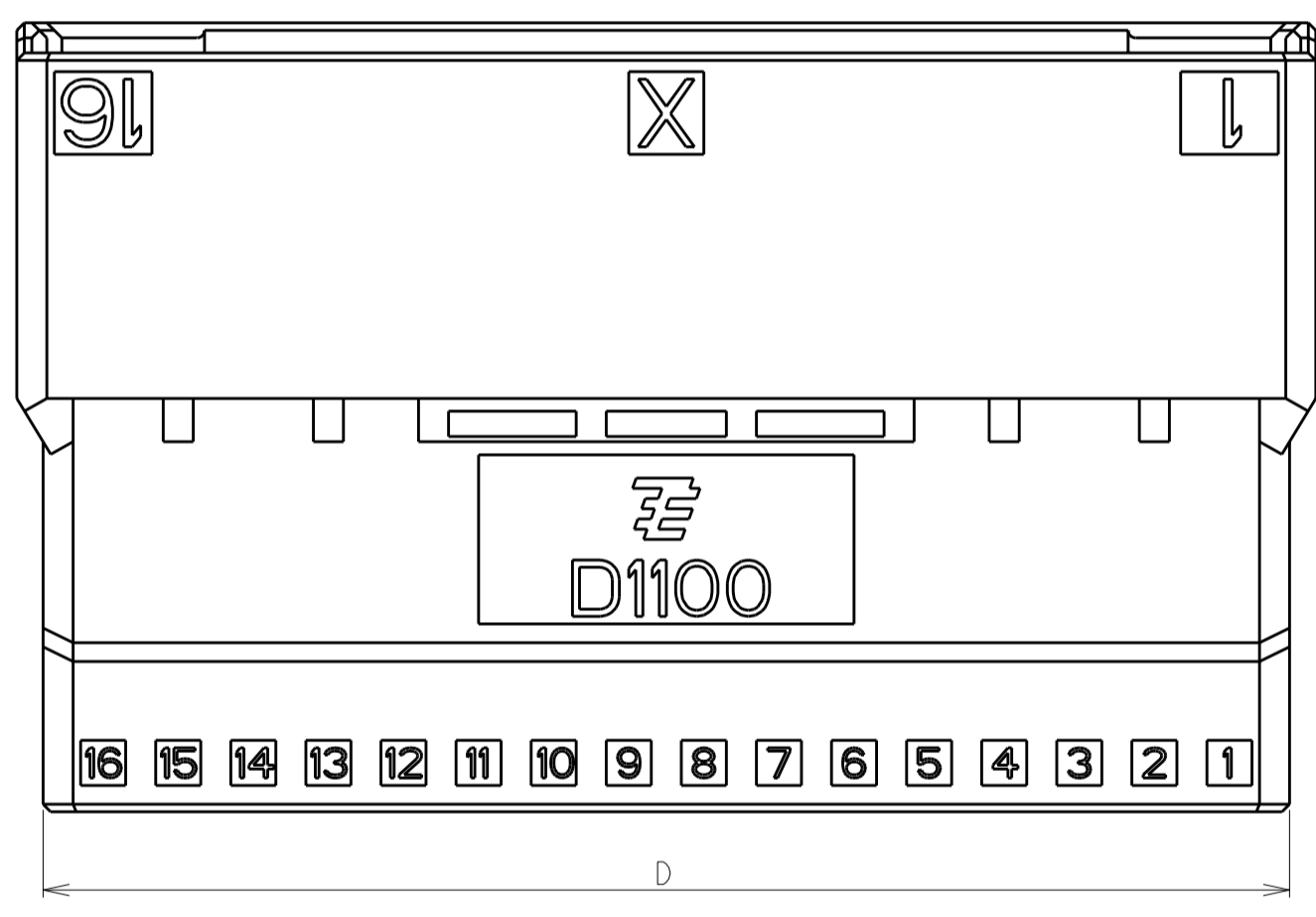
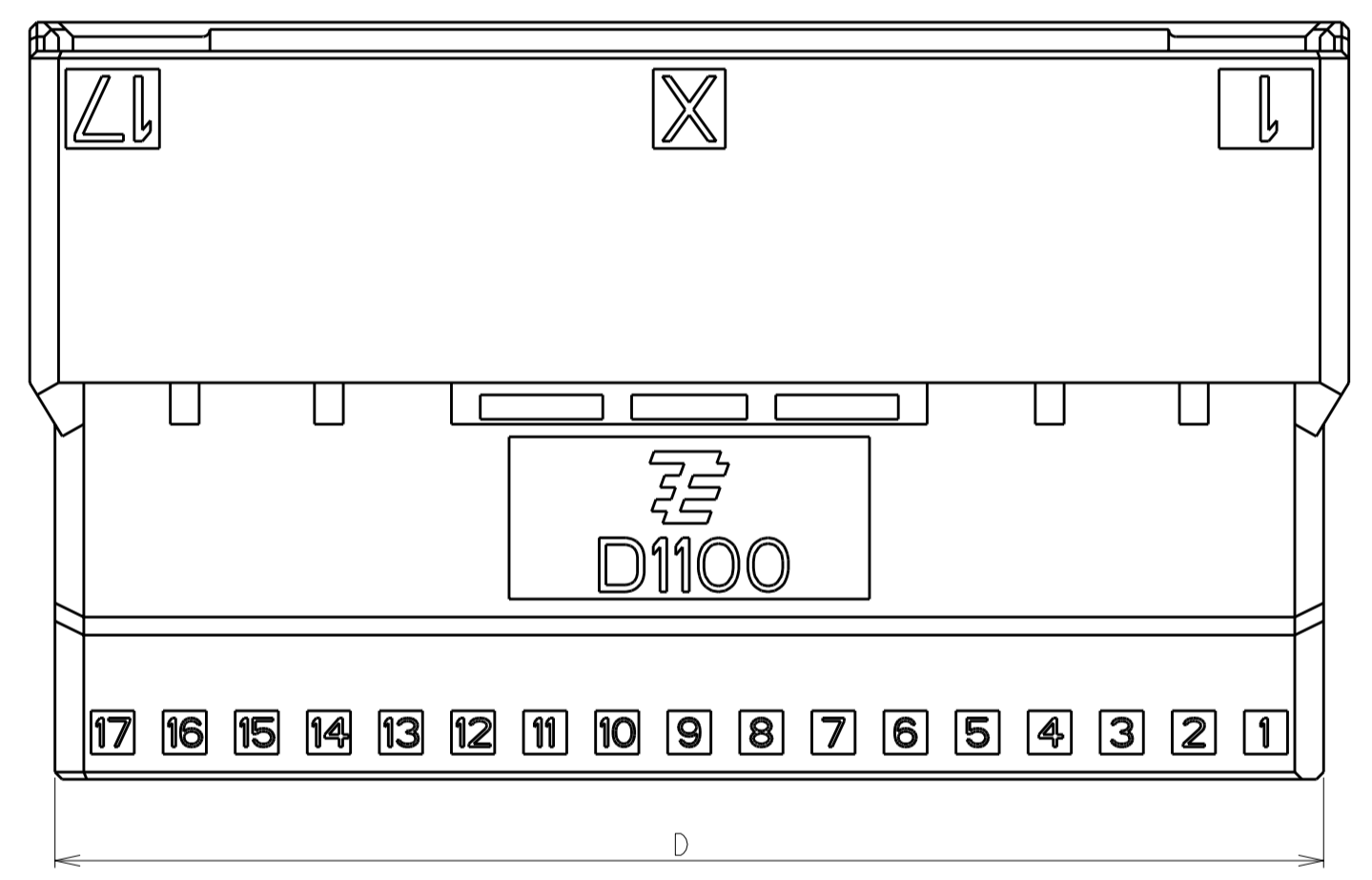

THIS DRAWING IS A CONTROLLED DOCUMENT FOR TYCO ELECTRONICS CORPORATION IT IS SUBJECT TO CHANGE AND THE CONTROLLING ENGINEERING ORGANIZATION SHOULD BE CONTACTED FOR THE LATEST REVISION.		DWN M. MAEBASHI 11APR2006 CHK T. KUDO 11APR2006 APVD D. MIISUGI 11APR2006	Tyco Electronics Tyco Electronics Corporation Kawasaki, Japan
DIMENSIONS: 单位: 毫米 mm	TOLERANCES UNLESS OTHERWISE SPECIFIED: 一般公差 0 PLC ± 1 PLC ± 2 PLC ± 3 PLC ± 4 PLC ± ANGLES ± FINISH 仕上	PRODUCT SPEC 製品規格 108-78268, 78298 APPLICATION SPEC 取付適用規格 114-5377	NAME 名称 DYNAMIC D1100D 2.0mm PITCH TAB HSG, FREE HANGING TYPE 22-40 POS
MATERIAL 材料	WEIGHT	SIZE 寸法 A260779	DRAWING NO. 番号 C-1903127
CUSTOMER DRAWING		SCALE 5:1	SHEET 2 OF 3 REV C

THIS DRAWING IS UNPUBLISHED. RELEASED FOR PUBLICATION 2006
 © COPYRIGHT 2006 BY TYCO ELECTRONICS CORPORATION. ALL INTERNATIONAL RIGHTS RESERVED.

LOC	DIST	REVISIONS					
J		P	LTR	DESCRIPTION	DATE	DWN	APVD
				SEE SHEET 1 OF 3			

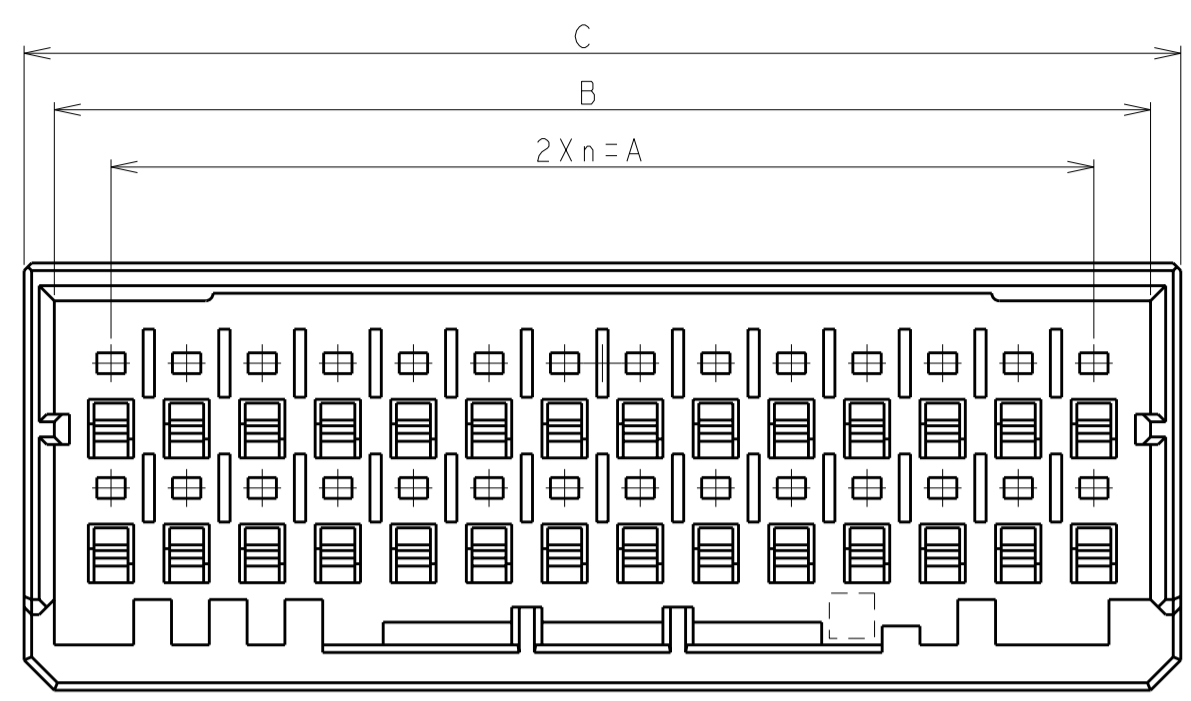

28POS(X-KEY): I-1903127-4

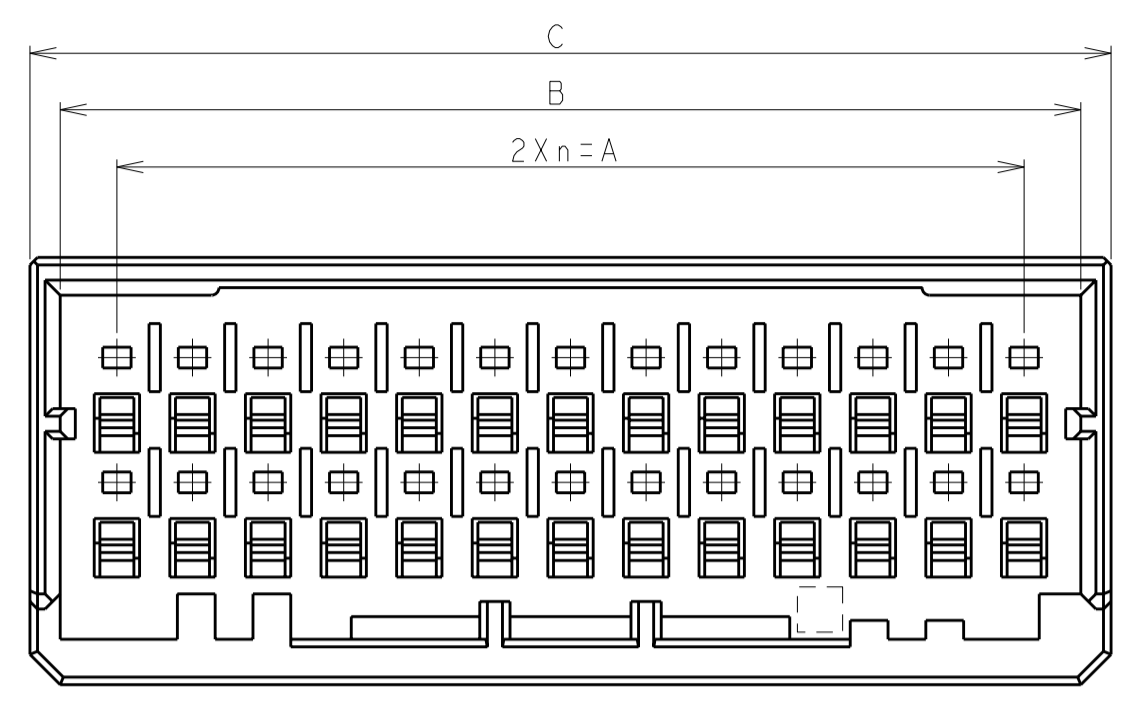

26POS(X-KEY): I-1903127-3

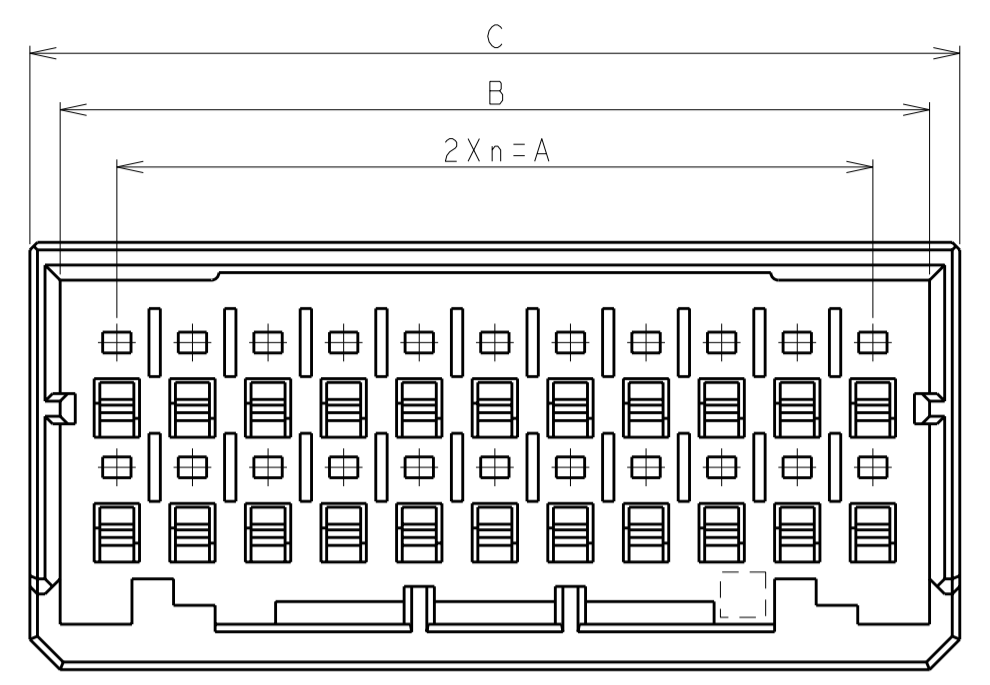

22POS(X-KEY): I-1903127-1

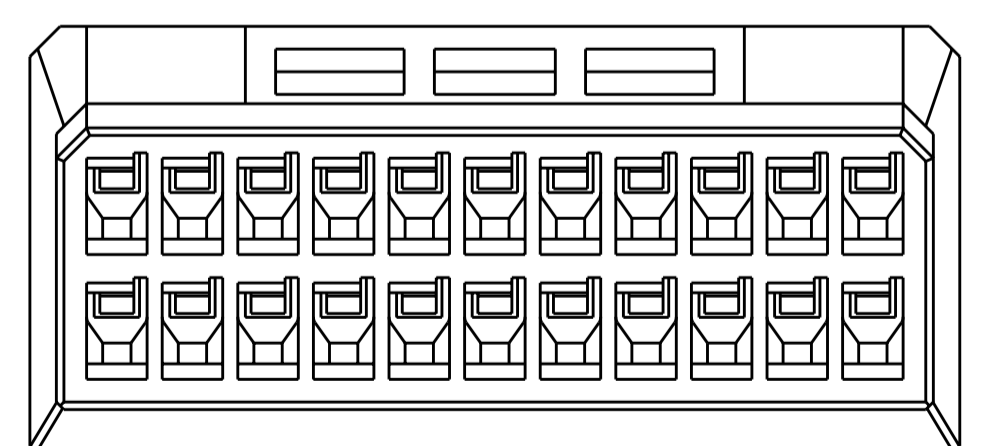
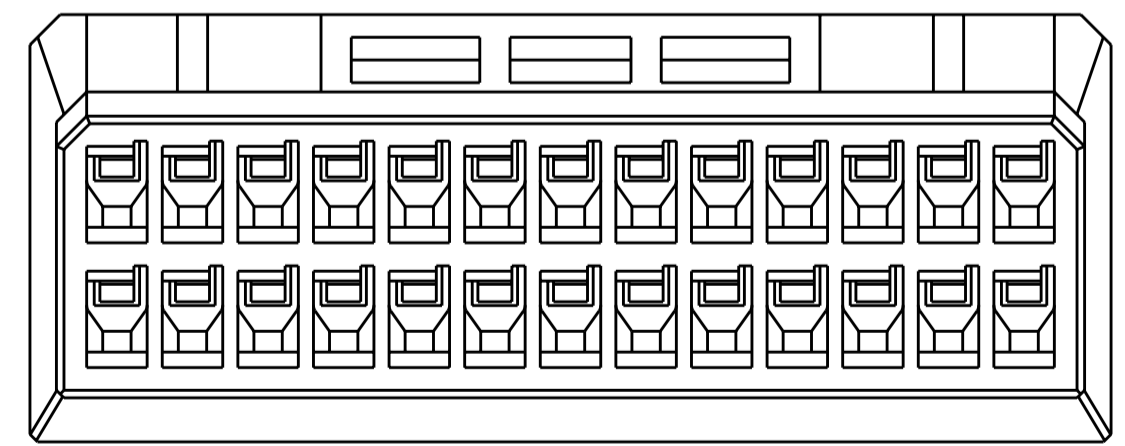
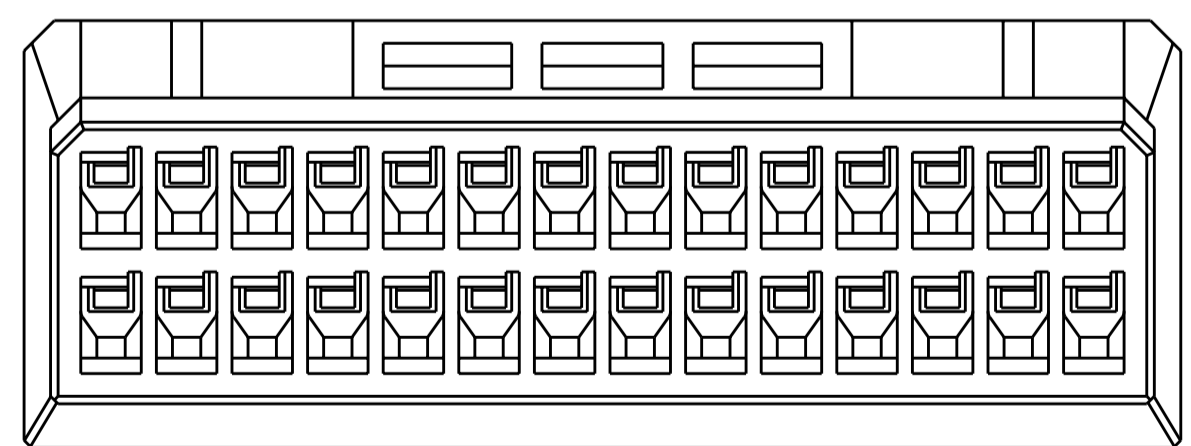
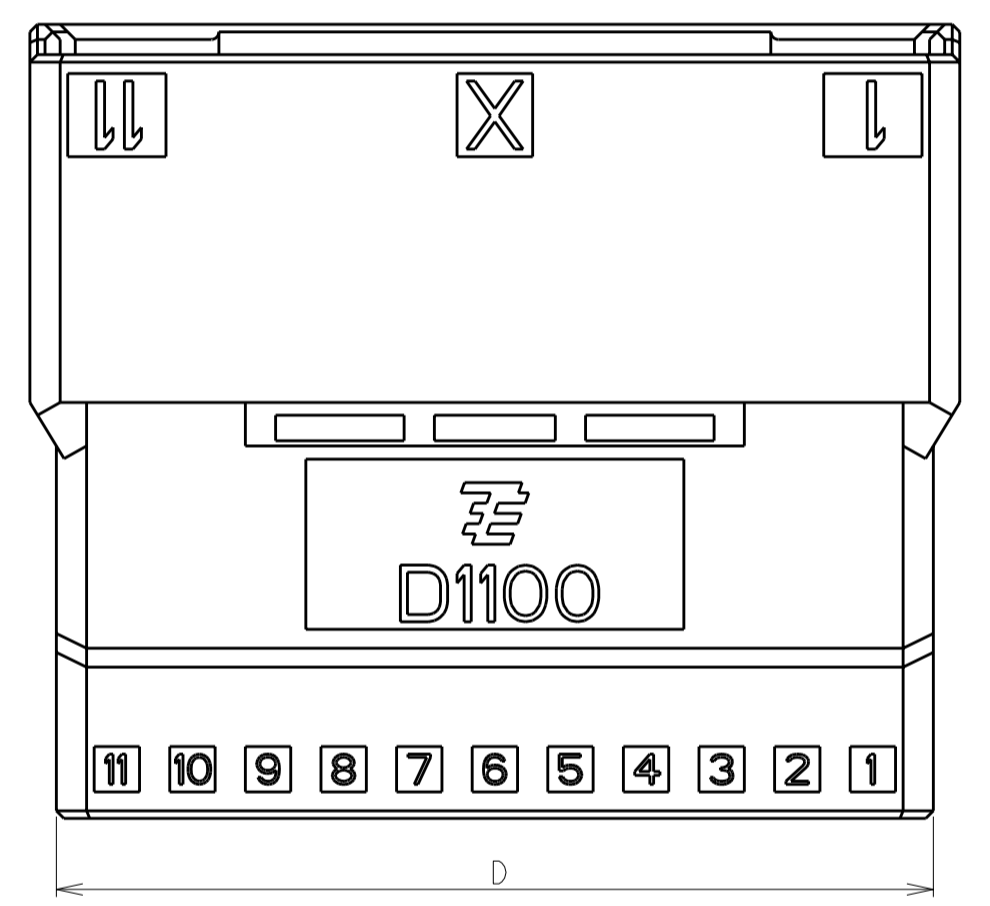
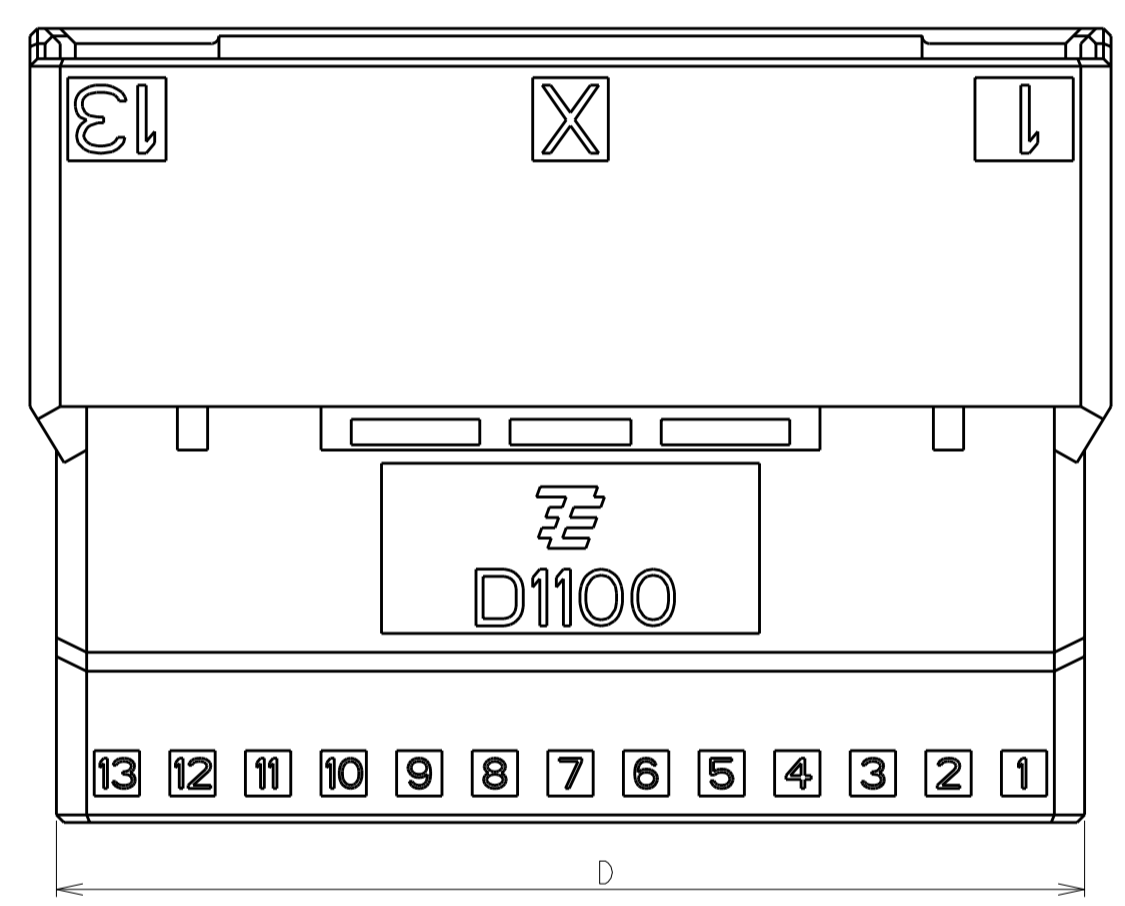
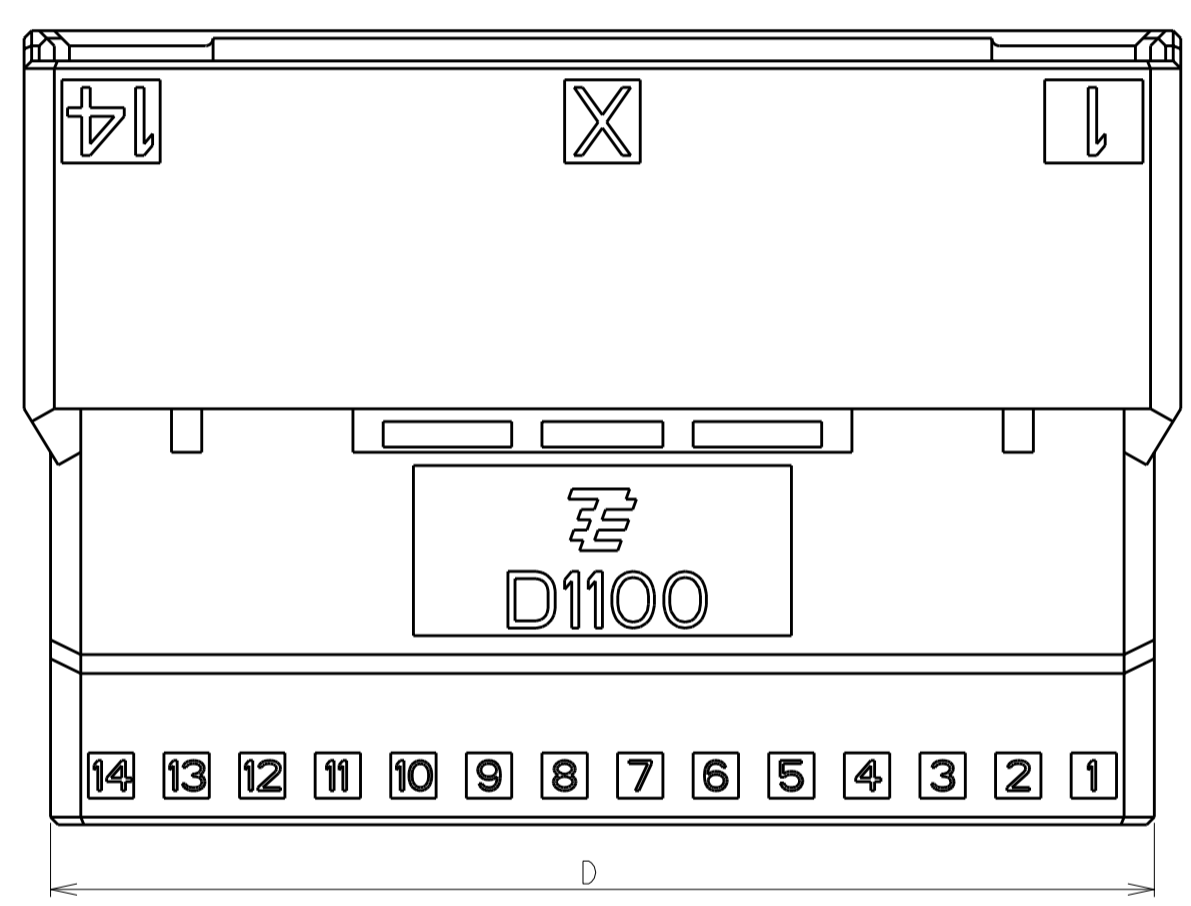

THIS DRAWING IS A CONTROLLED DOCUMENT FOR TYCO ELECTRONICS CORPORATION IT IS SUBJECT TO CHANGE AND THE CONTROLLING ENGINEERING ORGANIZATION SHOULD BE CONTACTED FOR THE LATEST REVISION.		DWN M. MAEBASHI 11APR2006 CHK T. KUDO 11APR2006 APVD D. MITSUGI 11APR2006	Tyco Electronics Tyco Electronics Corporation Kawasaki, Japan
DIMENSIONS: 単位: 純 mm	TOLERANCES UNLESS OTHERWISE SPECIFIED: 一般公差 0 PLC ± 1 PLC ± 2 PLC ± 3 PLC ± 4 PLC ± ANGLES ± FINISH 仕上	PRODUCT SPEC 製品規格 108-78268, 78298 APPLICATION SPEC 取付適用規格 114-5377 WEIGHT	NAME 名称 DYNAMIC D1100D 2.0mm PITCH TAB HSG, FREE HANGING TYPE 22-40 POS
MATERIAL 材料		SIZE A20779	DRAWING NO 番号 C-1903127
CUSTOMER DRAWING		SCALE 尺規 5:1	SHEET 3 OF 3 REV C



Компания «ЭлектроПласт» предлагает заключение долгосрочных отношений при поставках импортных электронных компонентов на взаимовыгодных условиях!

Наши преимущества:

- Оперативные поставки широкого спектра электронных компонентов отечественного и импортного производства напрямую от производителей и с крупнейших мировых складов;
- Поставка более 17-ти миллионов наименований электронных компонентов;
- Поставка сложных, дефицитных, либо снятых с производства позиций;
- Оперативные сроки поставки под заказ (от 5 рабочих дней);
- Экспресс доставка в любую точку России;
- Техническая поддержка проекта, помощь в подборе аналогов, поставка прототипов;
- Система менеджмента качества сертифицирована по Международному стандарту ISO 9001;
- Лицензия ФСБ на осуществление работ с использованием сведений, составляющих государственную тайну;
- Поставка специализированных компонентов (Xilinx, Altera, Analog Devices, Intersil, Interpoint, Microsemi, Aeroflex, Peregrine, Syfer, Eurofarad, Texas Instrument, Miteq, Cobham, E2V, MA-COM, Hittite, Mini-Circuits, General Dynamics и др.);

Помимо этого, одним из направлений компании «ЭлектроПласт» является направление «Источники питания». Мы предлагаем Вам помощь Конструкторского отдела:

- Подбор оптимального решения, техническое обоснование при выборе компонента;
- Подбор аналогов;
- Консультации по применению компонента;
- Поставка образцов и прототипов;
- Техническая поддержка проекта;
- Защита от снятия компонента с производства.



Как с нами связаться

Телефон: 8 (812) 309 58 32 (многоканальный)

Факс: 8 (812) 320-02-42

Электронная почта: org@eplast1.ru

Адрес: 198099, г. Санкт-Петербург, ул. Калинина, дом 2, корпус 4, литера А.