

Technische Information / Technical Information

IGBT-Module
IGBT-Modules

FP40R12KE3G

eupec

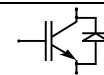

Vorläufige Daten
Preliminary data

Elektrische Eigenschaften / Electrical properties

Höchstzulässige Werte / Maximum rated values

Diode Gleichrichter/ Diode Rectifier

| | | | | |
|---|--|--------------|--------|----------------------|
| Periodische Rückw. Spitzensperrspannung repetitive peak reverse voltage | | V_{RRM} | 1600 | V |
| Gleichrichter Ausgang Grenzeffektivstrom maximum RMS current at Rectifier output | | I_{RMSmax} | t.b.d. | A |
| Dauergleichstrom DC forward current | $T_C = 80^\circ\text{C}$ | I_d | 40 | A |
| Stoßstrom Grenzwert surge forward current | $t_p = 10\text{ ms}, T_{vj} = 25^\circ\text{C}$ | I_{FSM} | 315 | A |
| | $t_p = 10\text{ ms}, T_{vj} = 150^\circ\text{C}$ | | 260 | A |
| Grenzlastintegral I^2t - value | $t_p = 10\text{ ms}, T_{vj} = 25^\circ\text{C}$ | I^2t | 500 | A^2s |
| | $t_p = 10\text{ ms}, T_{vj} = 150^\circ\text{C}$ | | 340 | A^2s |

Transistor Wechselrichter/ Transistor Inverter

| | | | | |
|--|---|-----------------------|---------|---|
| Kollektor-Emitter-Sperrspannung collector-emitter voltage | | V_{CES} | 1200 | V |
| Kollektor-Dauergleichstrom DC-collector current | $T_C = 80^\circ\text{C}$ | $I_{C,nom.}$ I_C | 40 | A |
| | $T_C = 25^\circ\text{C}$ | | 55 | A |
| Periodischer Kollektor Spitzenstrom repetitive peak collector current | $t_p = 1\text{ ms}, T_C = 80^\circ\text{C}$ | I_{CRM} | 80 | A |
| Gesamt-Verlustleistung total power dissipation | $T_C = 25^\circ\text{C}$ | P_{tot} | 200 | W |
| Gate-Emitter-Spitzenspannung gate-emitter peak voltage | | V_{GES} | +/- 20V | V |

Diode Wechselrichter/ Diode Inverter

| | | | | |
|--|--|-----------|-----|----------------------|
| Dauergleichstrom DC forward current | $T_C = 80^\circ\text{C}$ | I_F | 40 | A |
| Periodischer Spitzenstrom repetitive peak forw. current | $t_p = 1\text{ ms}$ | I_{FRM} | 80 | A |
| Grenzlastintegral I^2t - value | $V_R = 0\text{V}, t_p = 10\text{ms}, T_{vj} = 125^\circ\text{C}$ | I^2t | 320 | A^2s |

Transistor Brems-Chopper/ Transistor Brake-Chopper

| | | | | |
|--|---|-----------------------|---------|---|
| Kollektor-Emitter-Sperrspannung collector-emitter voltage | | V_{CES} | 1200 | V |
| Kollektor-Dauergleichstrom DC-collector current | $T_C = 80^\circ\text{C}$ | $I_{C,nom.}$ I_C | 40 | A |
| | $T_C = 25^\circ\text{C}$ | | 55 | A |
| Periodischer Kollektor Spitzenstrom repetitive peak collector current | $t_p = 1\text{ ms}, T_C = 80^\circ\text{C}$ | I_{CRM} | 80 | A |
| Gesamt-Verlustleistung total power dissipation | $T_C = 25^\circ\text{C}$ | P_{tot} | 200 | W |
| Gate-Emitter-Spitzenspannung gate-emitter peak voltage | | V_{GES} | +/- 20V | V |

Diode Brems-Chopper/ Diode Brake-Chopper

| | | | | |
|--|--------------------------|-----------|----|---|
| Dauergleichstrom DC forward current | $T_C = 80^\circ\text{C}$ | I_F | 15 | A |
| Periodischer Spitzenstrom repetitive peak forw. current | $t_p = 1\text{ ms}$ | I_{FRM} | 30 | A |

| | |
|-----------------------------|--------------------------------|
| prepared by: Andreas Schulz | date of publication:06.03.2001 |
| approved by: Hornkamp | revision: 1 |

Technische Information / Technical Information

IGBT-Module
IGBT-Modules

FP40R12KE3G

eupec

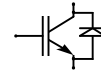

Vorläufige Daten Preliminary data

Modul Isolation/ Module Isolation

| | | | | |
|--|--|-------------------|-----|----|
| Isolations-Prüfspannung insulation test voltage | RMS, f = 50 Hz, t = 1 min. NTC connected to Baseplate | V _{ISOL} | 2,5 | kV |
|--|--|-------------------|-----|----|

Elektrische Eigenschaften / Electrical properties

Charakteristische Werte / Characteristic values

Diode Gleichrichter/ Diode Rectifier

| | | | min. | typ. | max. | |
|--|--|----------------------|------|------|------|----|
| Durchlaßspannung forward voltage | T _{vj} = 150°C, I _F = 40 A | V _F | - | 1,2 | - | V |
| Schleusenspannung threshold voltage | T _{vj} = 150°C | V _(TO) | - | - | 0,8 | V |
| Ersatzwiderstand slope resistance | T _{vj} = 150°C | r _T | - | - | 10,5 | mΩ |
| Sperrstrom reverse current | T _{vj} = 150°C, V _R = 1600 V | I _R | - | 2 | - | mA |
| Modul Leitungswiderstand, Anschlüsse-Chip lead resistance, terminals-chip | T _C = 25°C | R _{AA'+CC'} | - | 4 | - | mΩ |

Transistor Wechselrichter/ Transistor Inverter

| | | | min. | typ. | max. | |
|--|--|---------------------|------|------|------|-----|
| Kollektor-Emitter Sättigungsspannung collector-emitter saturation voltage | V _{GE} = 15V, T _{vj} = 25°C, I _C = 40 A | V _{CE sat} | - | 1,8 | 2,3 | V |
| | V _{GE} = 15V, T _{vj} = 125°C, I _C = 40 A | | - | 2,15 | - | V |
| Gate-Schwellenspannung gate threshold voltage | V _{CE} = V _{GE} , T _{vj} = 25°C, I _C = 1,5 mA | V _{GE(TO)} | 5,0 | 5,8 | 6,5 | V |
| Eingangskapazität input capacitance | f = 1MHz, T _{vj} = 25°C V _{CE} = 25 V, V _{GE} = 0 V | C _{ies} | - | 2,5 | - | nF |
| Kollektor-Emitter Reststrom collector-emitter cut off current | V _{GE} = 0V, T _{vj} = 25°C, V _{CE} = 1200 V | I _{CES} | - | - | 5 | mA |
| Gate-Emitter Reststrom gate-emitter leakage current | V _{CE} = 0V, V _{GE} = 20V, T _{vj} = 25°C | I _{GES} | - | - | 400 | nA |
| Einschaltverzögerungszeit (ind. Last) turn on delay time (inductive load) | I _C = I _{Nenn} , V _{CC} = 600 V | t _{d,on} | - | 85 | - | ns |
| | V _{GE} = ±15V, T _{vj} = 25°C, R _G = 27 Ohm | | | | | |
| | V _{GE} = ±15V, T _{vj} = 125°C, R _G = 27 Ohm | | | | | |
| Anstiegszeit (induktive Last) rise time (inductive load) | I _C = I _{Nenn} , V _{CC} = 600 V | t _r | - | 30 | - | ns |
| | V _{GE} = ±15V, T _{vj} = 25°C, R _G = 27 Ohm | | | | | |
| | V _{GE} = ±15V, T _{vj} = 125°C, R _G = 27 Ohm | | | | | |
| Abschaltverzögerungszeit (ind. Last) turn off delay time (inductive load) | I _C = I _{Nenn} , V _{CC} = 600 V | t _{d,off} | - | 420 | - | ns |
| | V _{GE} = ±15V, T _{vj} = 25°C, R _G = 27 Ohm | | | | | |
| | V _{GE} = ±15V, T _{vj} = 125°C, R _G = 27 Ohm | | | | | |
| Fallzeit (induktive Last) fall time (inductive load) | I _C = I _{Nenn} , V _{CC} = 600 V | t _f | - | 65 | - | ns |
| | V _{GE} = ±15V, T _{vj} = 25°C, R _G = 27 Ohm | | | | | |
| | V _{GE} = ±15V, T _{vj} = 125°C, R _G = 27 Ohm | | | | | |
| Einschaltverlustenergie pro Puls turn-on energy loss per pulse | I _C = I _{Nenn} , V _{CC} = 600 V V _{GE} = ±15V, T _{vj} = 125°C, R _G = 27 Ohm L _S = 45 nH | E _{on} | - | 6 | - | mWs |
| Abschaltverlustenergie pro Puls turn-off energy loss per pulse | I _C = I _{Nenn} , V _{CC} = 600 V V _{GE} = ±15V, T _{vj} = 125°C, R _G = 27 Ohm L _S = 45 nH | E _{off} | - | 4,2 | - | mWs |
| Kurzschlußverhalten SC Data | t _P ≤ 10µs, V _{GE} ≤ 15V, R _G = 27 Ohm T _{vj} ≤ 125°C, V _{CC} = 720 V | I _{SC} | - | 160 | - | A |

Technische Information / Technical Information

IGBT-Module
IGBT-Modules

FP40R12KE3G

eupec

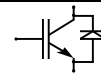

Vorläufige Daten Preliminary data

Elektrische Eigenschaften / Electrical properties

Charakteristische Werte / Characteristic values

| | | min. | typ. | max. | | |
|--|---|--------------|-------------|-------------|-----|------------|
| Modulinduktivität stray inductance module | | L_{GCE} | - | - | 100 | nH |
| Modul Leitungswiderstand, Anschlüsse-Chip lead resistance, terminals-chip | $T_C = 25^\circ C$ | R_{CC+EE} | - | 7 | - | m Ω |
| Diode Wechselrichter/ Diode Inverter | | min. | typ. | max. | | |
| Durchlaßspannung forward voltage | $V_{GE} = 0V, T_{vj} = 25^\circ C, I_F = 40 A$ $V_{GE} = 0V, T_{vj} = 125^\circ C, I_F = 40 A$ | V_F | - | 1,75 | 2,3 | V |
| Rückstromspitze peak reverse recovery current | $I_F = I_{Nenn}, -di_F/dt = 900 A/\mu s$ $V_{GE} = -10V, T_{vj} = 25^\circ C, V_R = 600 V$ $V_{GE} = -10V, T_{vj} = 125^\circ C, V_R = 600 V$ | I_{RM} | - | 39 | - | A |
| Sperrverzögerungsladung recovered charge | $I_F = I_{Nenn}, -di_F/dt = 900 A/\mu s$ $V_{GE} = -10V, T_{vj} = 25^\circ C, V_R = 600 V$ $V_{GE} = -10V, T_{vj} = 125^\circ C, V_R = 600 V$ | Q_r | - | 4,2 | - | μAs |
| Abschaltenergie pro Puls reverse recovery energy | $I_F = I_{Nenn}, -di_F/dt = 900 A/\mu s$ $V_{GE} = -10V, T_{vj} = 25^\circ C, V_R = 600 V$ $V_{GE} = -10V, T_{vj} = 125^\circ C, V_R = 600 V$ | E_{RQ} | - | 1,35 | - | mWs |
| Transistor Brems-Chopper/ Transistor Brake-Chopper | | min. | typ. | max. | | |
| Kollektor-Emitter Sättigungsspannung collector-emitter saturation voltage | $V_{GE} = 15V, T_{vj} = 25^\circ C, I_C = 40 A$ $V_{GE} = 15V, T_{vj} = 125^\circ C, I_C = 40 A$ | $V_{CE sat}$ | - | 1,8 | 2,3 | V |
| Gate-Schwellenspannung gate threshold voltage | $V_{CE} = V_{GE}, T_{vj} = 25^\circ C, I_C = 1,5 mA$ | $V_{GE(TO)}$ | 5,0 | 5,8 | 6,5 | V |
| Eingangskapazität input capacitance | $f = 1MHz, T_{vj} = 25^\circ C$ $V_{CE} = 25 V, V_{GE} = 0 V$ | C_{ies} | - | 2,5 | - | nF |
| Kollektor-Emitter Reststrom collector-emitter cut off current | $V_{GE} = 0V, T_{vj} = 25^\circ C, V_{CE} = 1200 V$ | I_{CES} | - | 5,0 | - | mA |
| Gate-Emitter Reststrom gate-emitter leakage current | $V_{CE} = 0V, V_{GE} = 20V, T_{vj} = 25^\circ C$ | I_{GES} | - | - | 400 | nA |
| Schaltverluste und -bedingungen Switching losses and conditions | siehe Wechselrichter in diesem Datenblatt see inverter in this datasheet | | | | | |
| Diode Brems-Chopper/ Diode Brake-Chopper | | min. | typ. | max. | | |
| Durchlaßspannung forward voltage | $T_{vj} = 25^\circ C, I_F = 40 A$ $T_{vj} = 125^\circ C, I_F = 40 A$ | V_F | - | 2,35 | 2,8 | V |
| Schaltverluste und -bedingungen Switching losses and conditions | siehe Wechselrichter in Dbl FP15R12KE3 see inverter in datasheet FP15R12KE3 | | | | | |
| NTC-Widerstand/ NTC-Thermistor | | min. | typ. | max. | | |
| Nennwiderstand rated resistance | $T_C = 25^\circ C$ | R_{25} | - | 5 | - | k Ω |
| Abweichung von R_{100} deviation of R_{100} | $T_C = 100^\circ C, R_{100} = 493 \Omega$ | $\Delta R/R$ | -5 | | 5 | % |
| Verlustleistung power dissipation | $T_C = 25^\circ C$ | P_{25} | | | 20 | mW |
| B-Wert B-value | $R_2 = R_1 \exp [B(1/T_2 - 1/T_1)]$ | $B_{25/50}$ | | 3375 | | K |

Technische Information / Technical Information

IGBT-Module
IGBT-Modules

FP40R12KE3G

eupec

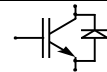

Vorläufige Daten Preliminary data

Thermische Eigenschaften / Thermal properties

| | | | | min. | typ. | max. | |
|--|---|------------|-----|------|------|------|--|
| Innerer Wärmewiderstand thermal resistance, junction to case | Gleichr. Diode/ Rectif. Diode | R_{thJC} | - | - | 1 | K/W | |
| | Trans. Wechs./ Trans. Inverter | | - | - | 0,6 | K/W | |
| | Diode Wechs./ Diode Inverter | | - | - | 0,95 | K/W | |
| | Trans. Bremse/ Trans. Brake | | - | - | 0,6 | K/W | |
| | Diode Bremse/ Diode Brake | | - | - | 1,5 | K/W | |
| Übergangs-Wärmewiderstand thermal resistance, case to heatsink | Gleichr. Diode/ Rectif. Diode $\lambda_{paste}=1W/m^2K$ | R_{thCK} | - | 0,04 | - | K/W | |
| | Trans. Wechs./ Trans. Inverter $\lambda_{grease}=1W/m^2K$ | | - | 0,02 | - | K/W | |
| | Diode Wechs./ Diode Inverter | | - | 0,04 | - | K/W | |
| Höchstzulässige Sperrschichttemperatur maximum junction temperature | | T_{vj} | - | - | 150 | °C | |
| Betriebstemperatur operation temperature | | T_{op} | -40 | - | 125 | °C | |
| Lagertemperatur storage temperature | | T_{stg} | -40 | - | 125 | °C | |

Mechanische Eigenschaften / Mechanical properties

| | | | | | |
|--|--|---|--|-----------------|----|
| Innere Isolation internal insulation | | | | Al_2O_3 | |
| CTI comperative tracking index | | | | 225 | |
| Anzugsdrehmoment f. mech. Befestigung mounting torque | | M | | 3 $\pm 10\%$ | Nm |
| Gewicht weight | | G | | 300 | g |

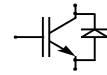

Vorläufige Daten
Preliminary data

Ausgangskennlinienfeld Wechselr. (typisch) $I_C = f(V_{CE})$
Output characteristic Inverter (typical) $V_{GE} = 15\text{ V}$

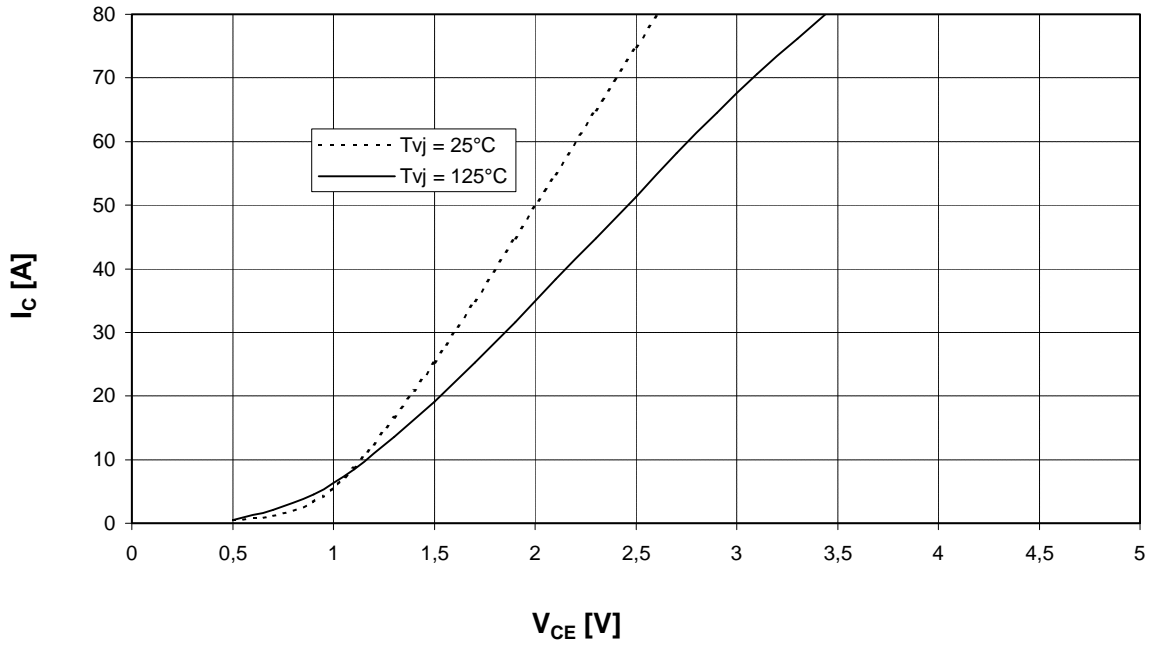

Ausgangskennlinienfeld Wechselr. (typisch) $I_C = f(V_{CE})$
Output characteristic Inverter (typical) $T_{vj} = 125^\circ\text{C}$

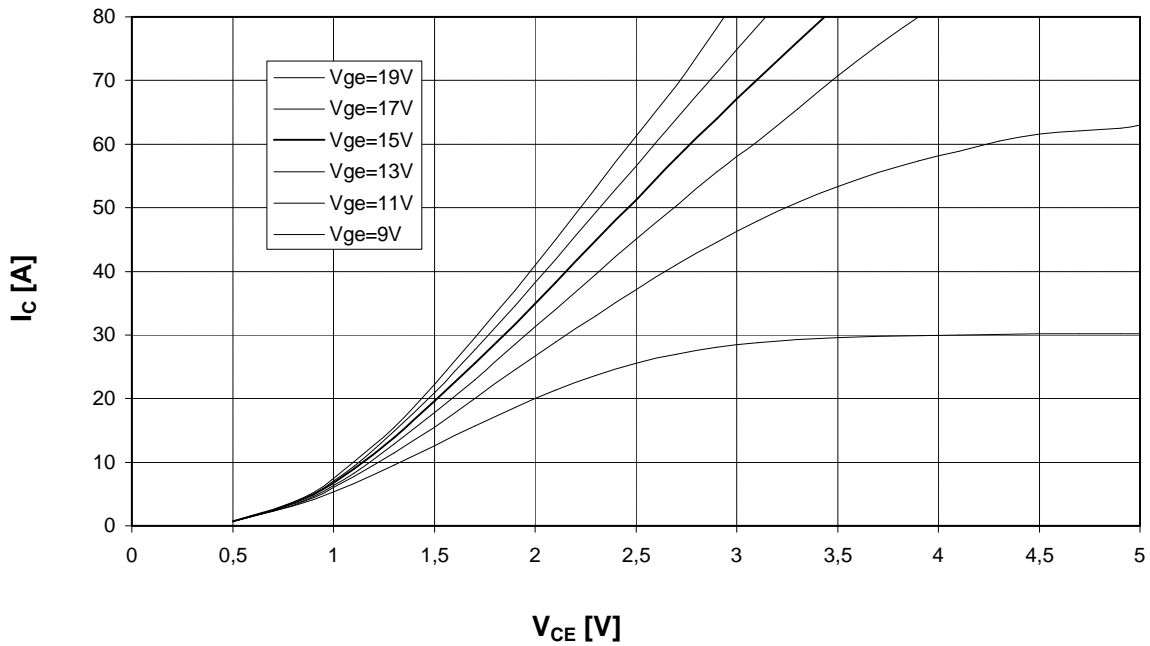

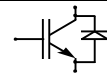

Vorläufige Daten
Preliminary data

Übertragungscharakteristik Wechselr. (typisch)
Transfer characteristic Inverter (typical)

$I_C = f(V_{GE})$
 $V_{CE} = 20\text{ V}$

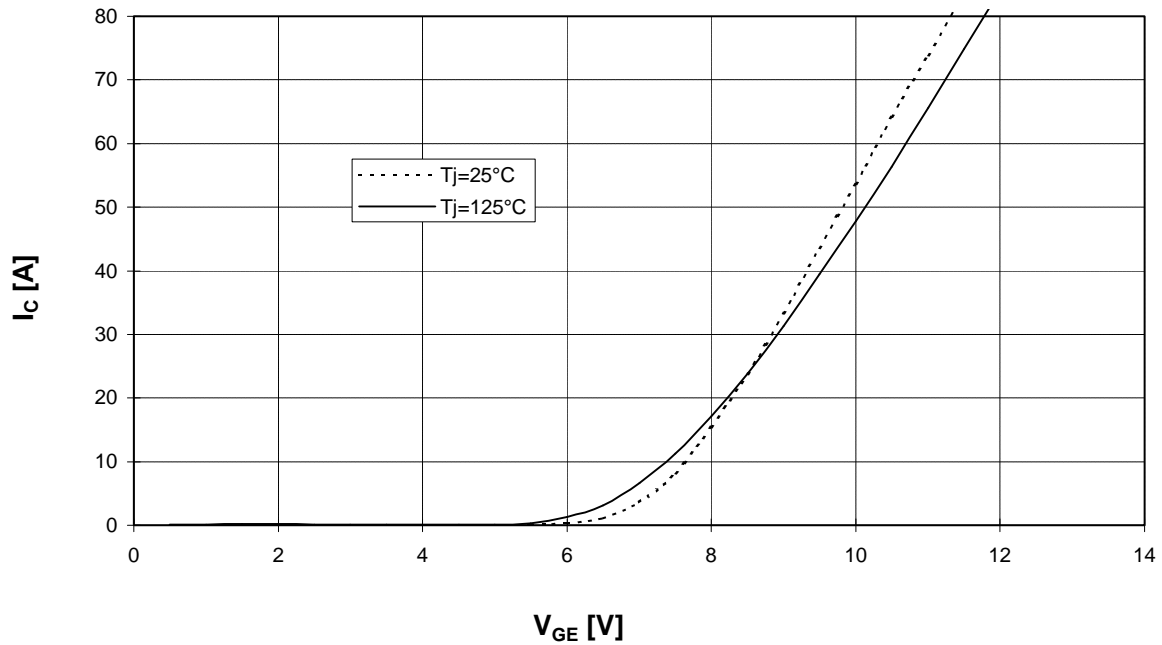

Durchlaßkennlinie der Freilaufdiode Wechselr. (typisch)
Forward characteristic of FWD Inverter (typical)

$I_F = f(V_F)$

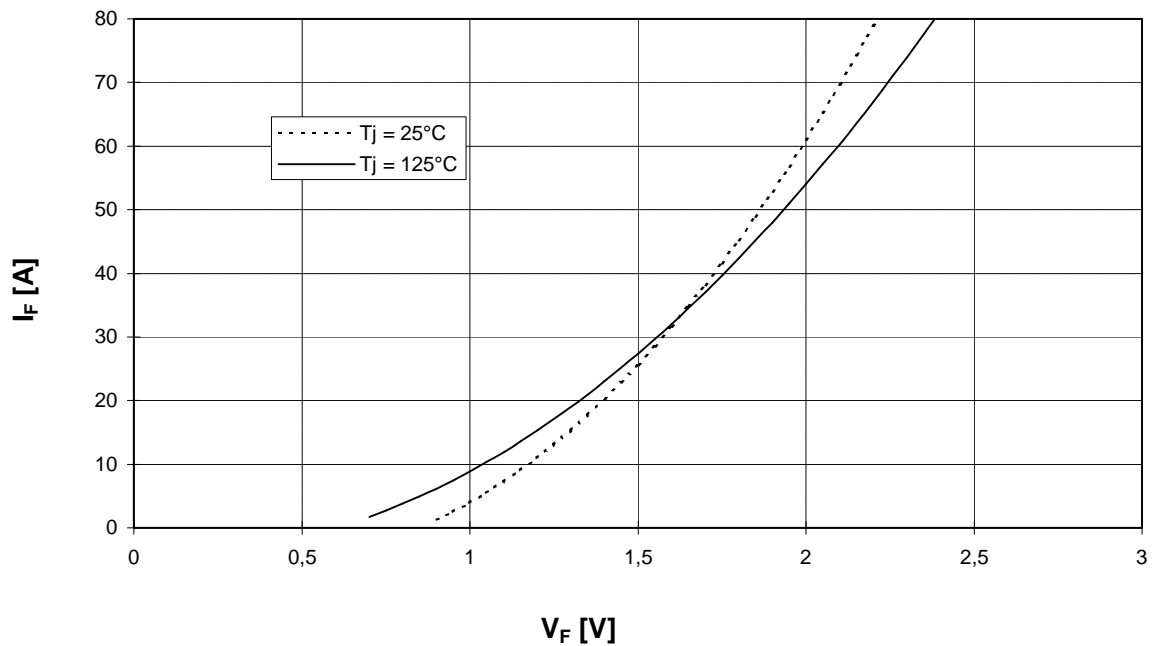

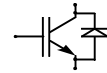

Vorläufige Daten
Preliminary data

Schaltverluste Wechselr. (typisch) $E_{on} = f(I_C), E_{off} = f(I_C), E_{rec} = f(I_C)$ $V_{CC} = 600\text{ V}$
 Switching losses Inverter (typical) $T_j = 125^\circ\text{C}, V_{GE} = \pm 15\text{ V}, R_{Gon} = R_{Goff} = 27\text{ Ohm}$

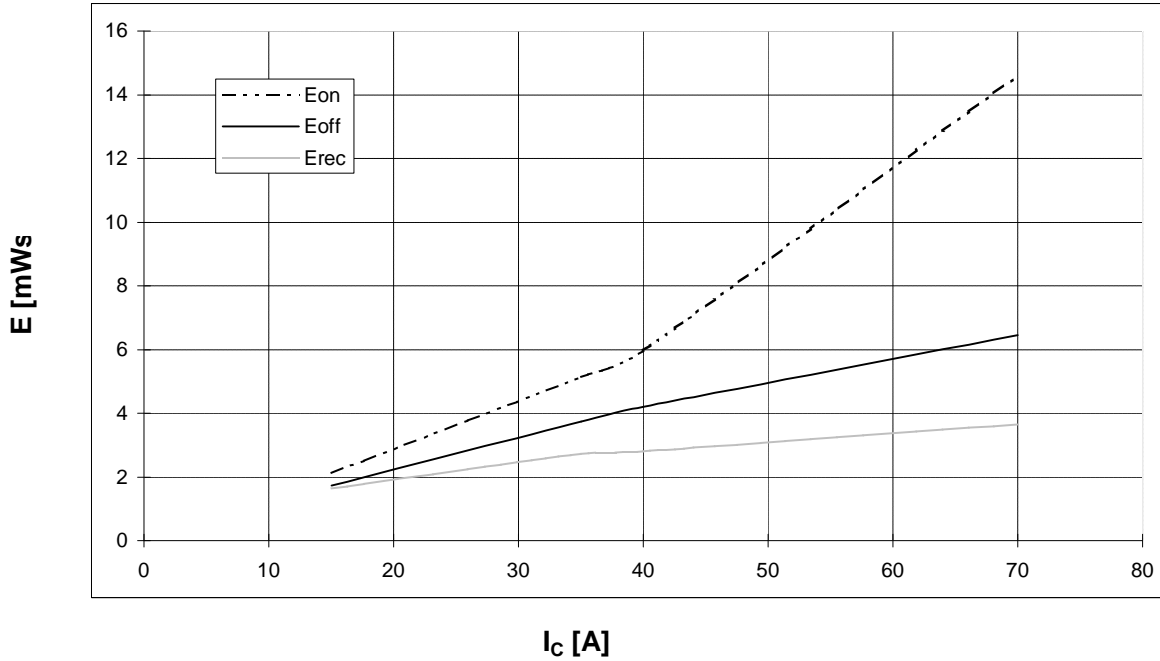

Schaltverluste Wechselr. (typisch) $E_{on} = f(R_G), E_{off} = f(R_G), E_{rec} = f(R_G)$
 Switching losses Inverter (typical) $T_j = 125^\circ\text{C}, V_{GE} = \pm 15\text{ V}, I_C = I_{nenn}, V_{CC} = 600\text{ V}$

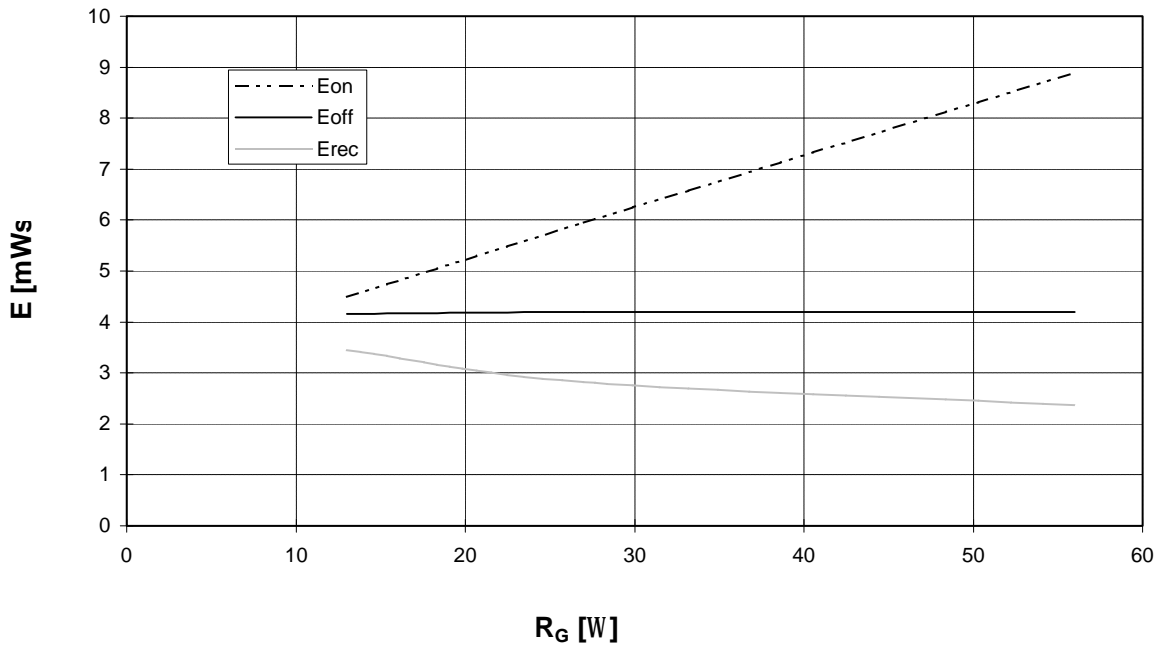

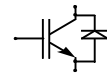

Vorläufige Daten
Preliminary data

Transienter Wärmewiderstand Wechslr. $Z_{thJC} = f(t)$
Transient thermal impedance Inverter

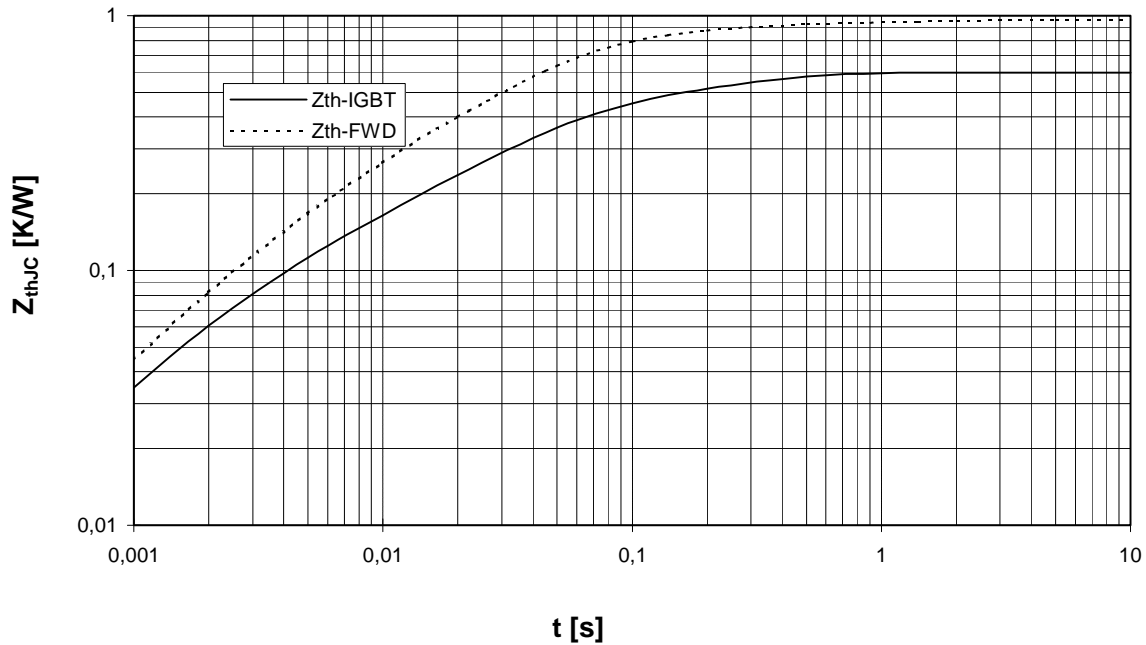

Sicherer Arbeitsbereich Wechslr. (RBSOA) $I_C = f(V_{CE})$
Reverse bias safe operating area Inverter (RBSOA) $T_{vi} = 125^\circ\text{C}, V_{GE} = \pm 15\text{V}, R_G = 27 \text{ Ohm}$

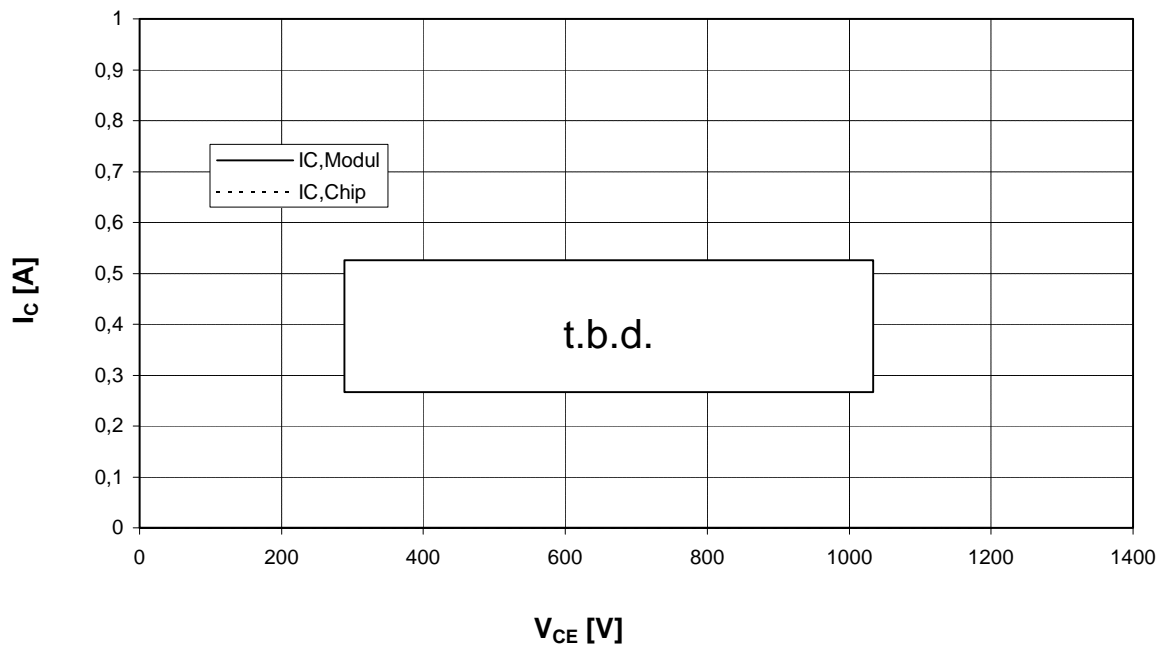

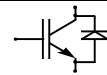

Vorläufige Daten
Preliminary data

Ausgangskennlinienfeld Brems-Chopper-IGBT (typisch)
Output characteristic brake-chopper-IGBT (typical)

$I_C = f(V_{CE})$
 $V_{GE} = 15\text{ V}$

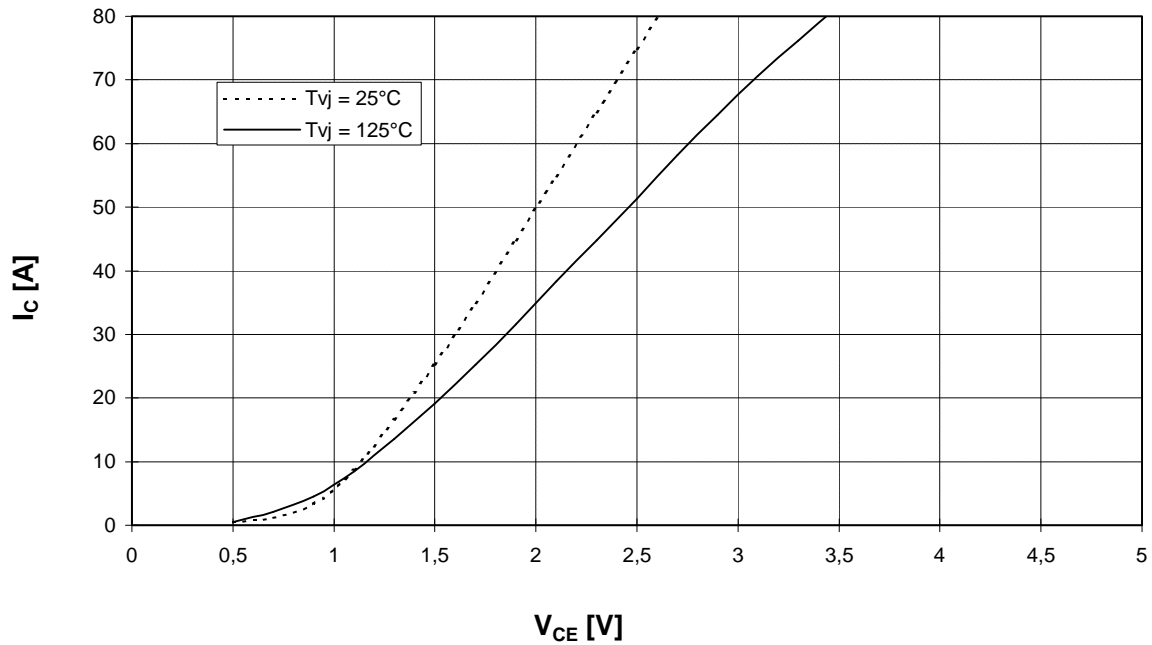

Durchlaßkennlinie der Brems-Chopper-Diode (typisch) $I_F = f(V_F)$
Forward characteristic of brake-chopper-FWD (typical)

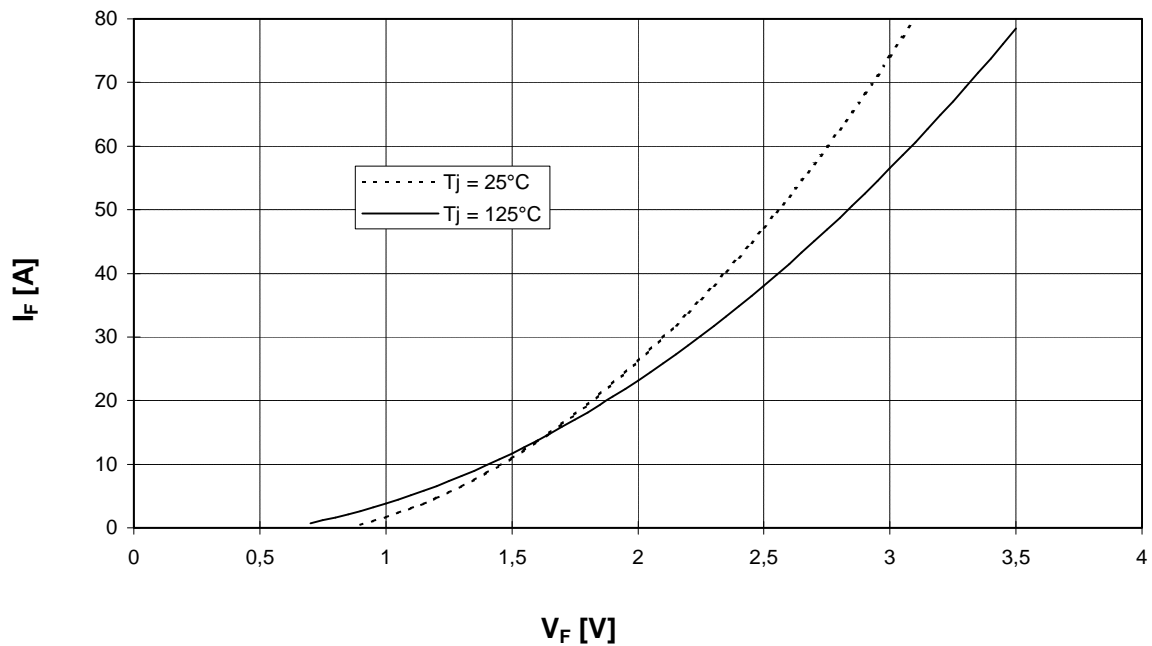

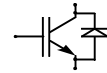

Vorläufige Daten
Preliminary data

Durchlaßkennlinie der Gleichrichterdiode (typisch) $I_F = f(V_F)$
Forward characteristic of Rectifier Diode (typical)

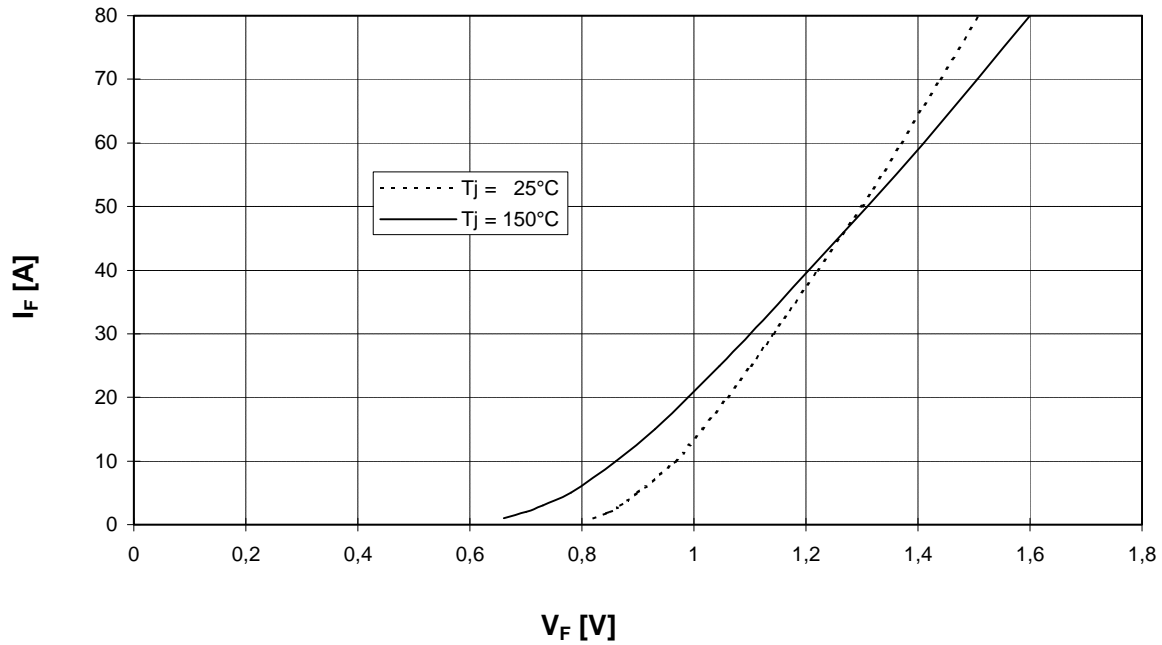

NTC- Temperaturkennlinie (typisch) $R = f(T)$
NTC- temperature characteristic (typical)

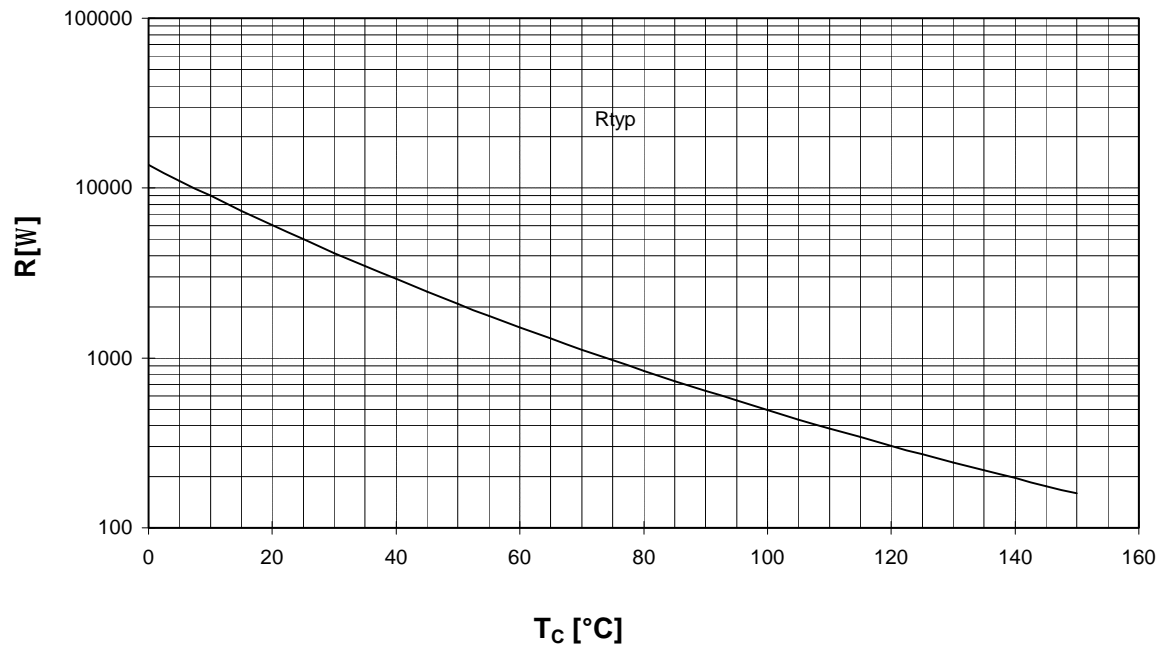

Technische Information / Technical Information

IGBT-Module
IGBT-Modules

FP40R12KE3G

eupec

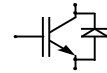

Vorläufige Daten
Preliminary data

Schaltplan/ Circuit diagram

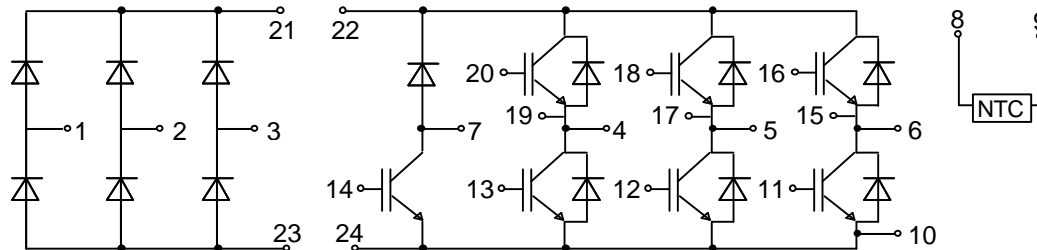

Gehäuseabmessungen/ Package outlines

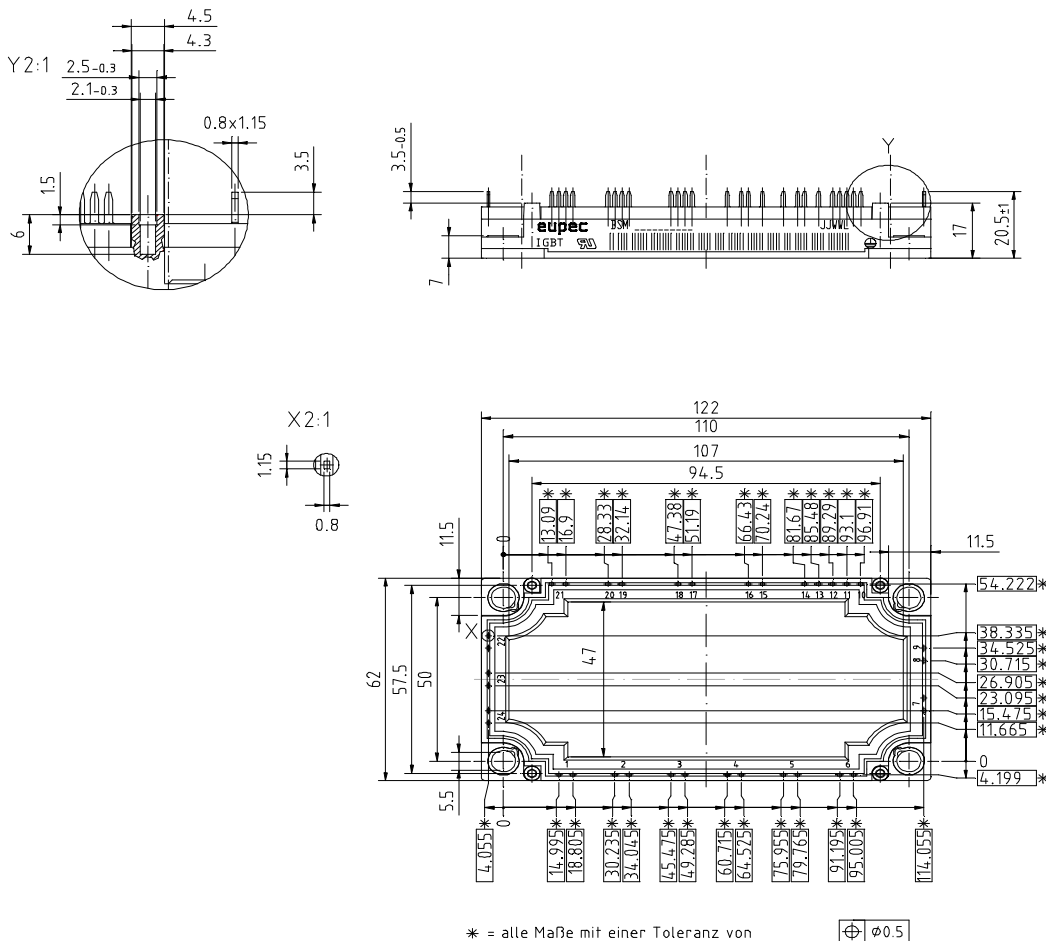

Mit dieser technischen Information werden Halbleiterbauelemente spezifiziert, jedoch keine Eigenschaften zugesichert. Sie gilt in Verbindung mit den zugehörigen Technischen Erläuterungen.

This technical information specifies semiconductor devices but promises no characteristics. It is valid in combination with the belonging technical notes.



Компания «ЭлектроПласт» предлагает заключение долгосрочных отношений при поставках импортных электронных компонентов на взаимовыгодных условиях!

Наши преимущества:

- Оперативные поставки широкого спектра электронных компонентов отечественного и импортного производства напрямую от производителей и с крупнейших мировых складов;
- Поставка более 17-ти миллионов наименований электронных компонентов;
- Поставка сложных, дефицитных, либо снятых с производства позиций;
- Оперативные сроки поставки под заказ (от 5 рабочих дней);
- Экспресс доставка в любую точку России;
- Техническая поддержка проекта, помощь в подборе аналогов, поставка прототипов;
- Система менеджмента качества сертифицирована по Международному стандарту ISO 9001;
- Лицензия ФСБ на осуществление работ с использованием сведений, составляющих государственную тайну;
- Поставка специализированных компонентов (Xilinx, Altera, Analog Devices, Intersil, Interpoint, Microsemi, Aeroflex, Peregrine, Syfer, Eurofarad, Texas Instrument, Miteq, Cobham, E2V, MA-COM, Hittite, Mini-Circuits, General Dynamics и др.);

Помимо этого, одним из направлений компании «ЭлектроПласт» является направление «Источники питания». Мы предлагаем Вам помощь Конструкторского отдела:

- Подбор оптимального решения, техническое обоснование при выборе компонента;
- Подбор аналогов;
- Консультации по применению компонента;
- Поставка образцов и прототипов;
- Техническая поддержка проекта;
- Защита от снятия компонента с производства.



Как с нами связаться

Телефон: 8 (812) 309 58 32 (многоканальный)

Факс: 8 (812) 320-02-42

Электронная почта: org@eplast1.ru

Адрес: 198099, г. Санкт-Петербург, ул. Калинина, дом 2, корпус 4, литера А.