

High Performance Switched Capacitor Universal Filter

FEATURES

- All Filter Parameters *Guaranteed* Over Temperature
- Wide Center Frequency Range (0.1Hz to 40kHz)
- Low Noise, Wide Dynamic Range
- *Guaranteed* Operation for $\pm 2.37V$ and $\pm 5V$ Supply
- Low Power Consumption
- *Guaranteed* Clock-to-Center Frequency Accuracy of 0.8%
- *Guaranteed* Low Offset Voltages Over Temperature
- Very Low Center Frequency and Q Tempco
- Clock Input T²L or CMOS Compatible
- Separate Highpass (or Notch or Allpass), Bandpass, Lowpass Outputs

APPLICATIONS

- Sinewave Oscillators
- Sweepable Bandpass/Notch Filters
- Full Audio Frequency Filters
- Tracking Filters

LT, LTC and LT are registered trademarks of Linear Technology Corporation.
 LTCMOS trademark of Linear Technology Corporation.

DESCRIPTION

The LTC[®]1059 consists of a general purpose, high performance, active filter building block and an uncommitted op amp. The filter building block together with an external clock and 2 to 5 resistors can produce various 2nd order functions which are available at its three output pins. Two out of three always provide lowpass and bandpass functions while the third output pin can produce notch or highpass or allpass. The center frequency of these functions can be tuned from 0.1Hz to 40kHz and is dependent on an external clock or an external clock and a resistor ratio. The filter can handle input frequencies up to 100kHz. The uncommitted op amp can be used to obtain additional allpass and notch functions, for gain adjustment or for cascading techniques.

Higher than 2nd order filter functions can be obtained by cascading the LTC1059 with the LTC1060 dual universal filter or the LTC1061 triple universal filter. Any classical filter realization (such as Butterworth, Cauer, Bessel and Chebyshev) can be formed.

The LTC1059 can be operated with single or dual supplies ranging from $\pm 2.37V$ to $\pm 8V$ (or 4.74V to 16V single supply).

The LTC1059 is manufactured by using Linear Technology's enhanced LTCMOS[™] silicon gate process.

TYPICAL APPLICATION

Wide Range 2nd Order Bandpass/Notch Filter with Q = 10

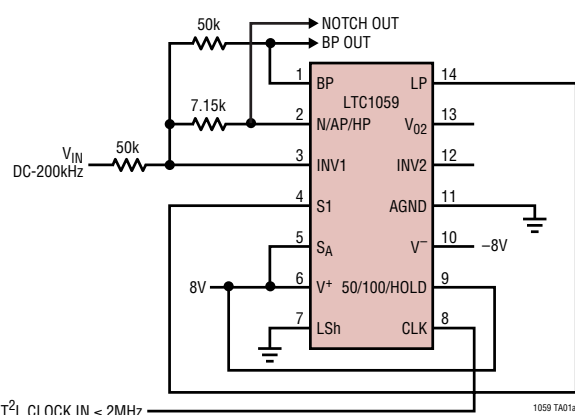

Center Frequency and Q Error

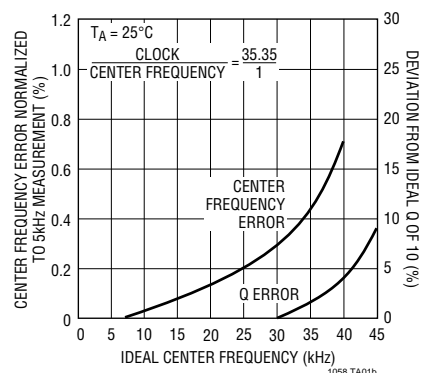

ABSOLUTE MAXIMUM RATINGS

(Note 1)

| | |
|--|---|
| Supply Voltage | 18V |
| Power Dissipation | 500mW |
| Operating Temperature Range | |
| LTC1059C | $-40^{\circ}\text{C} \leq T_A \leq 85^{\circ}\text{C}$ |
| LTC1059AM, LTC1059M | $-55^{\circ}\text{C} \leq T_A \leq 125^{\circ}\text{C}$ |
| Storage Temperature Range | -65°C to 150°C |
| Lead Temperature (Soldering, 10 sec) | 300°C |

PACKAGE/ORDER INFORMATION

| TOP VIEW | | ORDER PART NUMBER |
|--|--------------------|--|
| BP [1] | 14 LP | LTC1059CN LTC1059CS |
| N/AP/HP [2] | 13 V _{O2} | |
| INV1 [3] | 12 INV2 | |
| S1 [4] | 11 AGND | |
| S _A [5] | 10 V ⁻ | |
| V ⁺ [6] | 9 50/100/HOLD | |
| LSh [7] | 8 CLK | |
| N PACKAGE 14-LEAD PDIP S PACKAGE 14-LEAD PLASTIC SO $T_{JMAX} = 110^{\circ}\text{C}$, $\theta_{JA} = 130^{\circ}\text{C/W}$ (N) $T_{JMAX} = 110^{\circ}\text{C}$, $\theta_{JA} = 110^{\circ}\text{C/W}$ (S) | | LTC1059ACJ LTC1059AMJ LTC1059CJ LTC1059MJ |
| J PACKAGE 14-LEAD CERDIP $T_{JMAX} = 150^{\circ}\text{C}$, $\theta_{JA} = 80^{\circ}\text{C/W}$ | | |
| OBSELETE PACKAGE Consider the N or S Package for Alternate Source | | |

Consult LTC Marketing for parts specified with wider operating temperature ranges.

ELECTRICAL CHARACTERISTICS

The ● denotes the specifications which apply over the full operating temperature range, otherwise specifications are at $T_A = 25^{\circ}\text{C}$.

(Complete Filter) $V_S = \pm 5\text{V}$, T^2L clock input level unless otherwise specified.

| PARAMETER | CONDITIONS | MIN | TYP | MAX | UNITS |
|---------------------------------|--|-----|-----------|-----------------------------------|--------|
| Center Frequency Range, f_0 | $f_0 \bullet Q \leq 400\text{kHz}$, Mode 1 $f_0 \bullet Q \leq 1.6\text{MHz}$, Mode 1 $f_0 \bullet Q \leq 250\text{kHz}$, Mode 3, $V_S = \pm 7.5\text{V}$ $f_0 \bullet Q \leq 1\text{MHz}$, Mode 3, $V_S = \pm 7.5\text{V}$ | | 0.1 - 40k | | Hz |
| Input Frequency Range | | | 0 - 200k | | Hz |
| Clock-to-Center Frequency Ratio | Mode 1, 50:1, $f_{CLK} = 250\text{kHz}$, $Q = 10$ ● Mode 1, 100:1, $f_{CLK} = 500\text{kHz}$, $Q = 10$ ● | | | $50 \pm 0.8\%$ $100 \pm 0.8\%$ | |
| Q Accuracy | Mode 1, 50:1 or 100:1, $f_0 = 5\text{kHz}$, $Q = 10$ ● | | ± 0.5 | 5 | % |
| f_0 Temperature Coefficient | Mode 1, $f_{CLK} < 500\text{kHz}$ | | 5 | | ppm/°C |
| Q Temperature Coefficient | Mode 1, $f_{CLK} < 500\text{kHz}$, $Q = 10$ | | 15 | | ppm/°C |
| DC Offset | | | | | mV |
| V_{OS1} | $f_{CLK} = 250\text{kHz}$, 50:1, S_A High (N Package) | ● | 2 | 15 | mV |
| V_{OS2} | $f_{CLK} = 250\text{kHz}$, 50:1, S_A High (S Package) | ● | 3 | 30 | mV |
| V_{OS2} | $f_{CLK} = 500\text{kHz}$, 100:1, S_A High (N Package) | ● | 3 | 40 | mV |
| V_{OS2} | $f_{CLK} = 500\text{kHz}$, 100:1, S_A High (S Package) | ● | 6 | 60 | mV |
| V_{OS2} | $f_{CLK} = 250\text{kHz}$, 50:1, S_A Low (N Package) | ● | 6 | 80 | mV |
| V_{OS2} | $f_{CLK} = 250\text{kHz}$, 50:1, S_A Low (S Package) | ● | 2 | 20 | mV |
| V_{OS2} | $f_{CLK} = 250\text{kHz}$, 50:1, S_A Low (S Package) | ● | 2 | 30 | mV |
| V_{OS2} | $f_{CLK} = 500\text{kHz}$, 100:1, S_A Low (N Package) | ● | 4 | 40 | mV |
| V_{OS2} | $f_{CLK} = 500\text{kHz}$, 100:1, S_A Low (S Package) | ● | 4 | 60 | mV |
| V_{OS3} | $f_{CLK} = 250\text{kHz}$, 50:1 (N Package) | ● | 2 | 20 | mV |
| V_{OS3} | $f_{CLK} = 250\text{kHz}$, 50:1 (S Package) | ● | 2 | 30 | mV |
| V_{OS3} | $f_{CLK} = 500\text{kHz}$, 100:1 (N Package) | ● | 4 | 40 | mV |
| V_{OS3} | $f_{CLK} = 500\text{kHz}$, 100:1 (S Package) | ● | 4 | 60 | mV |

ELECTRICAL CHARACTERISTICS

The ● denotes the specifications which apply over the full operating temperature range, otherwise specifications are at $T_A = 25^\circ\text{C}$.

(Complete Filter) $V_S = \pm 5\text{V}$, T²L Clock Input Level unless otherwise specified.

| PARAMETER | CONDITIONS | MIN | TYP | MAX | UNITS |
|---------------------------|--|-----|-----------|----------|----------|
| DC Lowpass Gain Accuracy | Mode 1, $R_1 = R_2 = 50\text{k}\Omega$ | ● | ± 0.1 | 2 | % |
| BP Gain Accuracy at f_0 | Mode 1, $Q = 10$, $f_0 = 5\text{kHz}$ | | ± 0.1 | | % |
| Clock Feedthrough | $f_{\text{CLK}} \leq 1\text{MHz}$ | | 10 | | mV |
| Max Clock Frequency | Mode 1, $Q < 5$, $V_S \geq \pm 5\text{V}$ | | 2 | | MHz |
| Power Supply Current | | ● | 3.5 | 5.5 7 | mA mA |

(Complete Filter) $V_S = \pm 2.37\text{V}$ unless otherwise specified.

| PARAMETER | CONDITIONS | MIN | TYP | MAX | UNITS |
|---------------------------------|---|-----|-----------------------------------|-----|----------|
| Center Frequency Range | $f_0 \cdot Q \leq 120\text{kHz}$, Mode 1, 50:1 $f_0 \cdot Q \leq 120\text{kHz}$, Mode 3, 50:1 | | 0.1 - 12k 0.1 - 10k | | Hz Hz |
| Input Frequency Range | | | 60k | | Hz |
| Clock-to-Center Frequency Ratio | Mode 1, 50:1, $f_{\text{CLK}} = 250\text{kHz}$, $Q = 10$ Mode 1, 100:1, $f_{\text{CLK}} = 250\text{kHz}$, $Q = 10$ | | $50 \pm 0.8\%$ $100 \pm 0.8\%$ | | |
| Q Accuracy | Mode 1, $f_{\text{CLK}} = 250\text{kHz}$, $Q = 10$ 50:1 and 100:1 | | ± 2 | | % |
| Max Clock Frequency | | | 700 | | kHz |
| Power Supply Current | | | 1.5 | 2.5 | mA |

(Internal Op Amps) The ● denotes the specifications which apply over the full operating temperature range, otherwise specifications are at $T_A = 25^\circ\text{C}$.

| PARAMETER | CONDITIONS | MIN | TYP | MAX | UNITS |
|--|--|-------------|------------------------|-----------|------------------|
| Supply Voltage Range | | ± 2.375 | | ± 8 | V |
| Voltage Swings | $V_S = \pm 5\text{V}$, $R_L = 5\text{k}$ (Pins 1, 14) $R_L = 3.5\text{k}$ (Pins 2, 13) | ● | ± 3.8 ± 3.6 | ± 4.2 | V V |
| Input Offset Voltage | | ● | 1 | 15 | mV |
| Input Bias Current | | | 3 | | pA |
| Output Short-Circuit Current Source/Sink | $V_S = \pm 5\text{V}$ (N Package) $V_S = \pm 5\text{V}$ (S Package) | | 40/3 25/3 | | mA mA |
| DC Open Loop Gain | $V_S = \pm 5\text{V}$ | | 80 | | dB |
| GBW | $V_S = \pm 5\text{V}$ | | 2 | | MHz |
| Slew Rate | $V_S = \pm 5\text{V}$ | | 7 | | V/ μs |

Note 1: Absolute Maximum Ratings are those values beyond which the life of a device may be impaired.

TYPICAL PERFORMANCE CHARACTERISTICS

**Graph 1. Mode 1:
(f_{CLK}/f_0) Deviation vs Q**

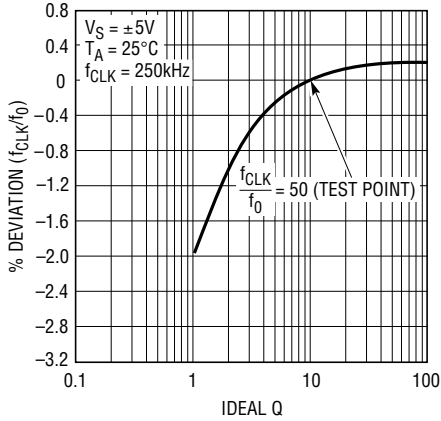

1060 G01

**Graph 2. Mode 1:
(f_{CLK}/f_0) Deviation vs Q**

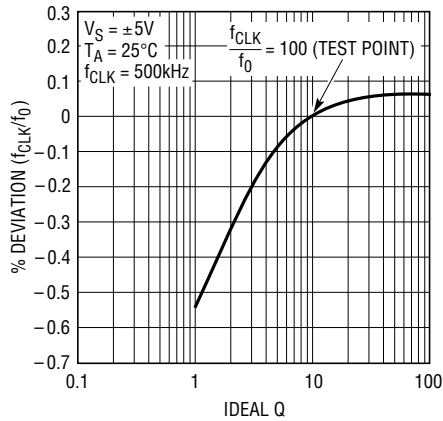

1060 G02

**Graph 3. Mode 1: Q Error
vs Clock Frequency**

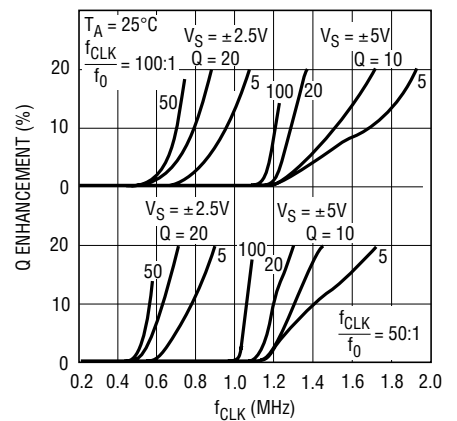

1060 G03

**Graph 4. Mode 1: Q Error
vs Clock Frequency**

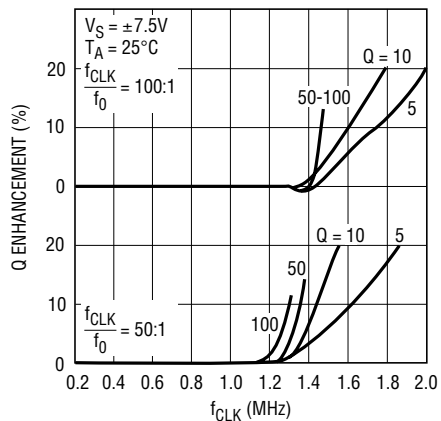

1059 G04

**Graph 5. Mode 1: Measured Q
vs f_{CLK} and Temperature**

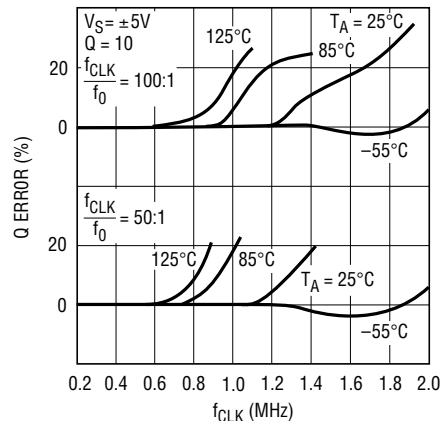

1059 G05

**Graph 6. Mode 1: (f_{CLK}/f_0)
vs f_{CLK} and Q**

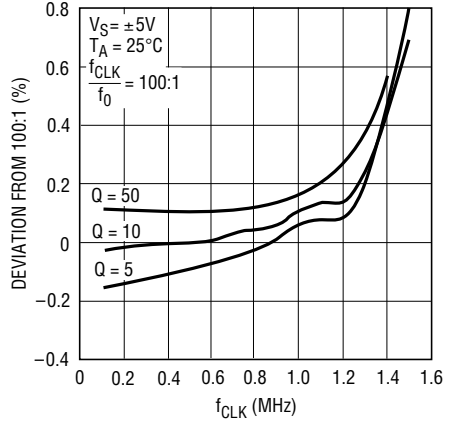

1059 G06

**Graph 7. Mode 1: (f_{CLK}/f_0)
vs f_{CLK} and Q**

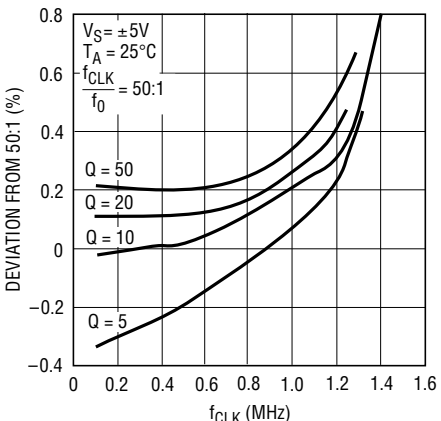

1059 G07

**Graph 8. Mode 1: (f_{CLK}/f_0)
vs f_{CLK} and Temperature**

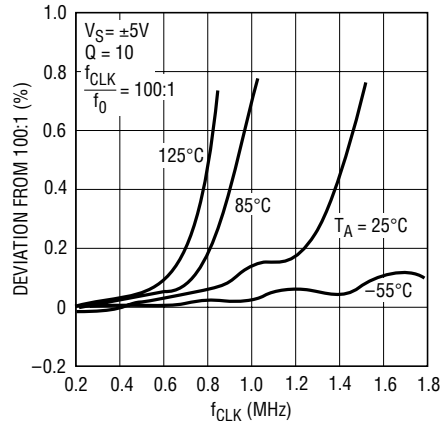

1059 G08

**Graph 9. Mode 1: (f_{CLK}/f_0)
vs f_{CLK} and Temperature**

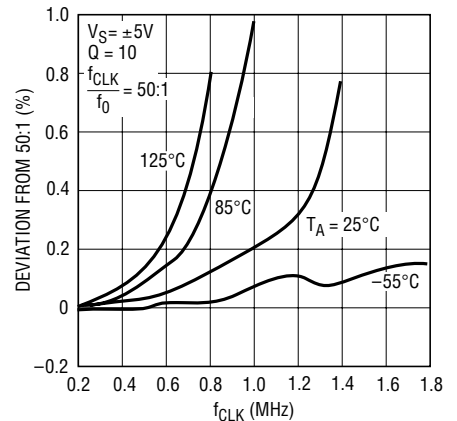

1059 G09

TYPICAL PERFORMANCE CHARACTERISTICS

Graph 10. Mode 1: (f_{CLK}/f_0) vs f_{CLK} and Q

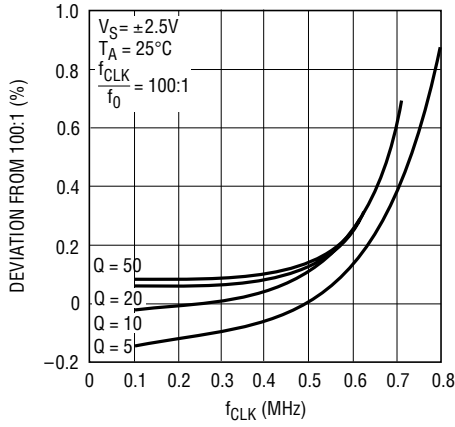

1059 G10

Graph 11. Mode 1: (f_{CLK}/f_0) vs f_{CLK} and Q

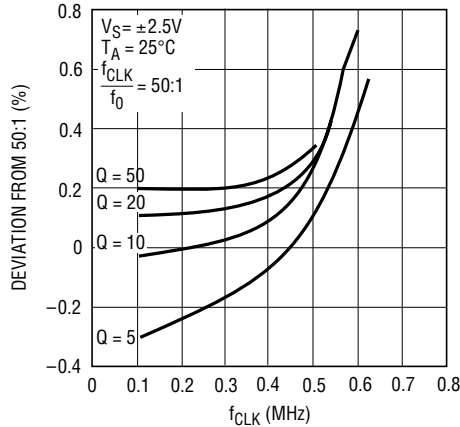

1059 G11

Graph 12. Mode 1: (f_{CLK}/f_0) vs f_{CLK} and Temperature

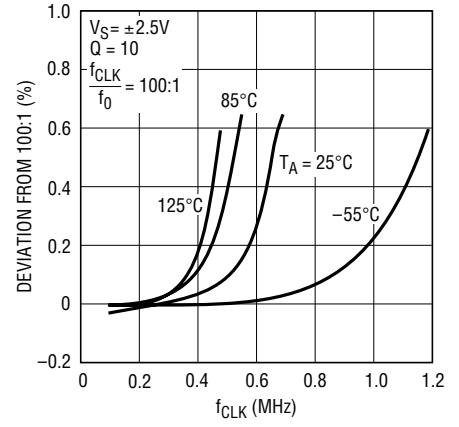

1059 • G12

Graph 13. Mode 1: (f_{CLK}/f_0) vs f_{CLK} and Temperature

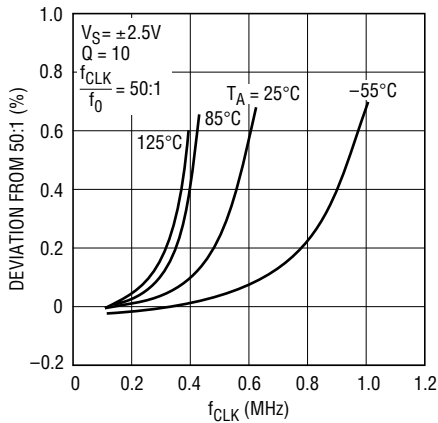

1059 G13

Graph 14. Mode 1: Notch Depth vs Clock Frequency

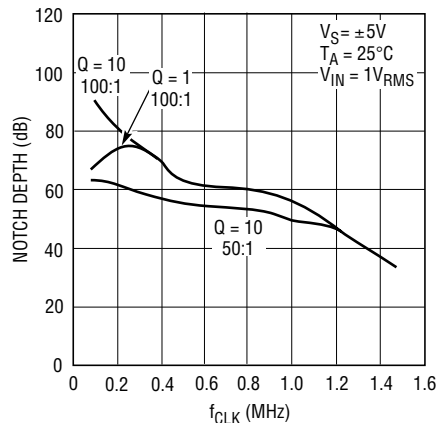

1059 G14

Graph 15. Mode 3: Deviation of (f_{CLK}/f_0) with Respect to Q = 10 Measurement

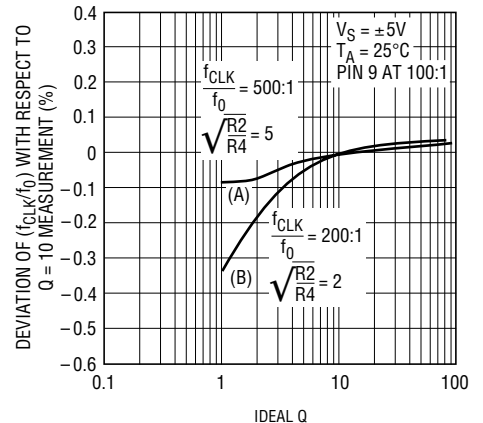

1059 G15

Graph 16. Mode 3: Q Error vs Clock Frequency

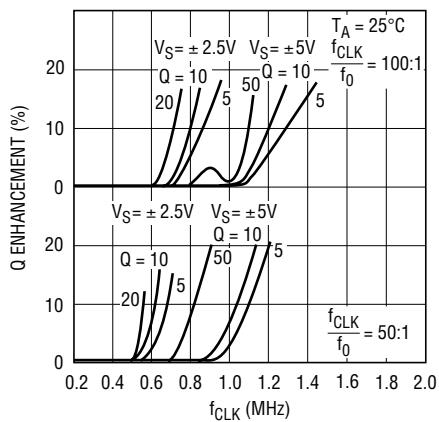

1059 G16

Graph 17. Mode 3 (R2 = R4): Q Error vs Clock Frequency

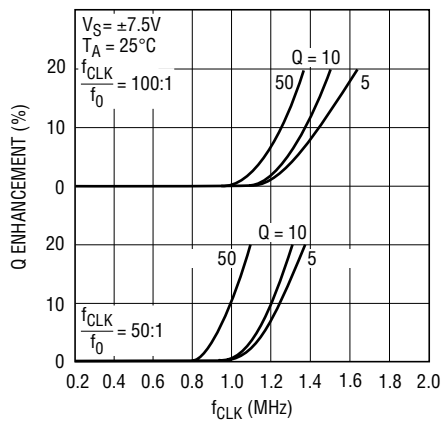

1059 G17

Graph 18. Mode 3 (R2 = R4): Measured Q vs f_{CLK} and Temperature

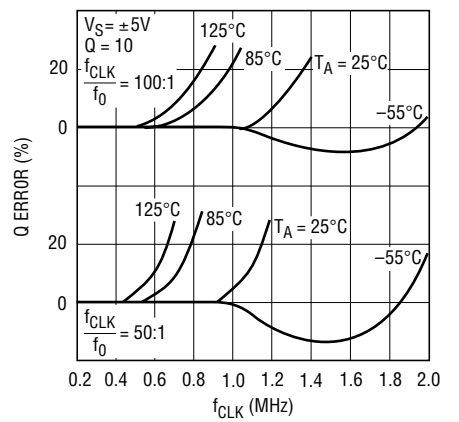

1059 G18

1059fd

TYPICAL PERFORMANCE CHARACTERISTICS

**Graph 19. Mode 3 (R2 = R4):
(f_{CLK}/f₀) vs f_{CLK} and Q**

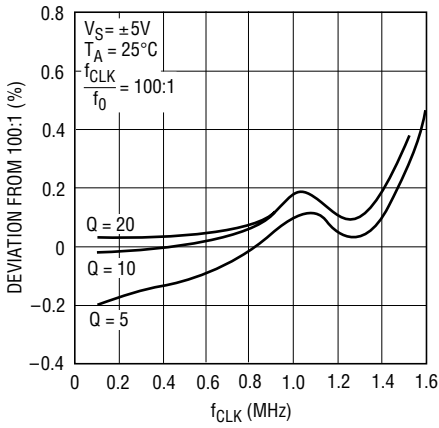

1059 G19

**Graph 20. Mode 3 (R2 = R4):
(f_{CLK}/f₀) vs f_{CLK} and Q**

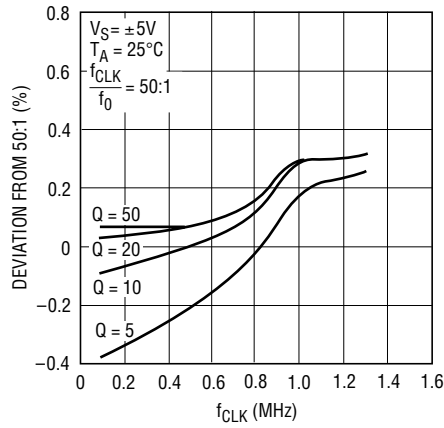

1059 G20

**Graph 21. Mode 3 (R2 = R4):
(f_{CLK}/f₀) vs f_{CLK} and Temperature**

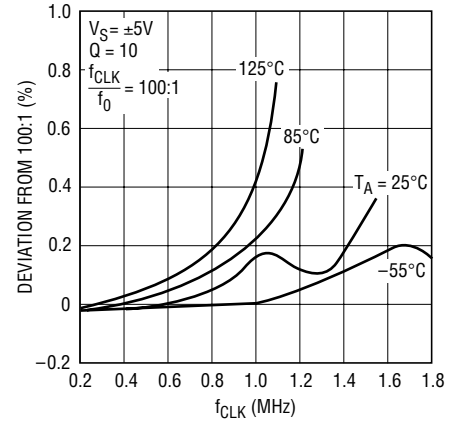

1059 G21

**Graph 22. Mode 3 (R2 = R4):
(f_{CLK}/f₀) vs f_{CLK} and Temperature**

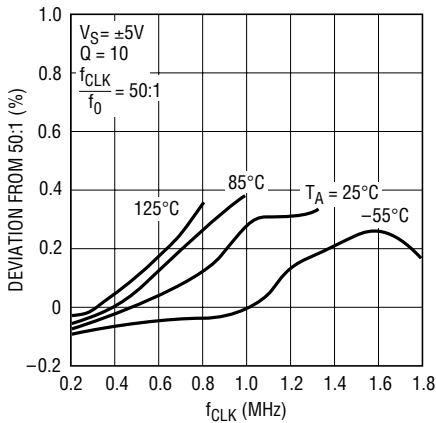

1059 G22

**Graph 23. Mode 3 (R2 = R4):
(f_{CLK}/f₀) vs f_{CLK} and Temperature**

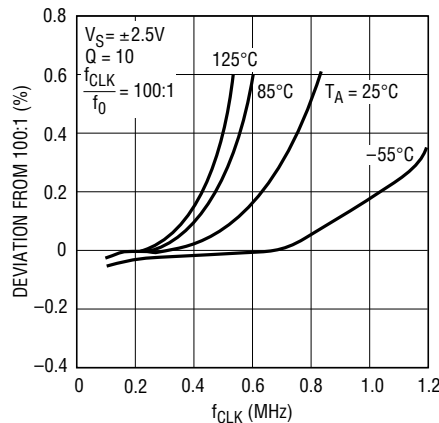

1059 G23

**Graph 24. Mode 3 (R2 = R4):
(f_{CLK}/f₀) vs f_{CLK} and Temperature**

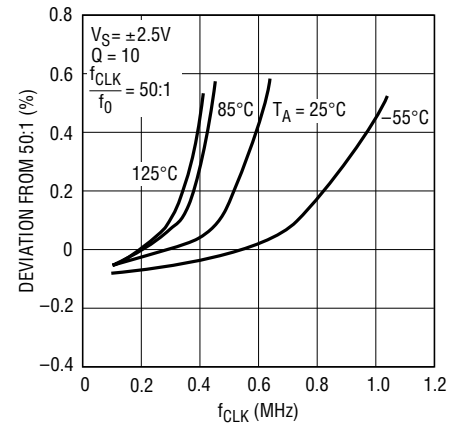

1059 G24

**Graph 25. Mode 1c (R5 = 0),
Mode 2 (R2 = R4): Q Error vs
Clock Frequency**

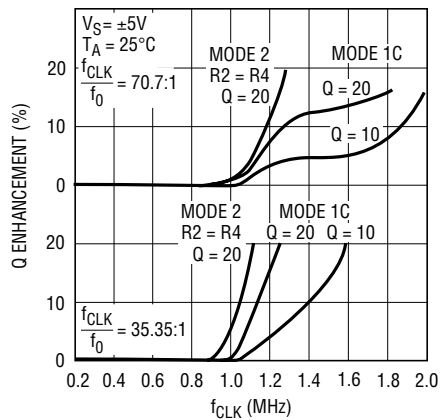

1059 G25

**Graph 26. Supply Current
vs Supply Voltage**

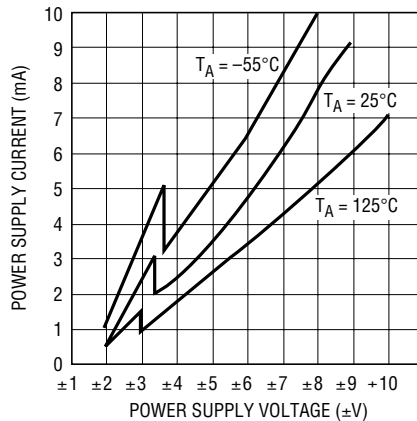

1059 G26

1059fd

BLOCK DIAGRAM

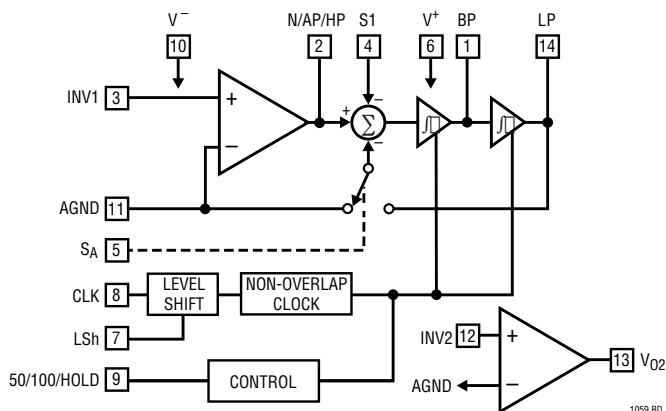

APPLICATIONS INFORMATION

The LTC1059 is compatible with the LTC1060. All the LTC1059 pins are functionally equivalent to the LTC1060 pins bearing the same title. For a detailed pin description and definition of various modes of operation refer to the LTC1060 data sheet. The LTC1059 is typically “faster” than the LTC1060 especially under single 5V (or ±2.5V) supply

operation. This becomes apparent through the Typical Performance Characteristics of the part. All the graphs shown in this data sheet have been drawn under the same test conditions as in the LTC1060 data sheet; they are also numbered in the same order. For complete discussion of the filter characteristics see the LTC1060 data sheet.

PACKAGE DESCRIPTION

J Package
14-Lead CERDIP (Narrow .300 Inch, Hermetic)
 (Reference LTC DWG # 05-08-1110)

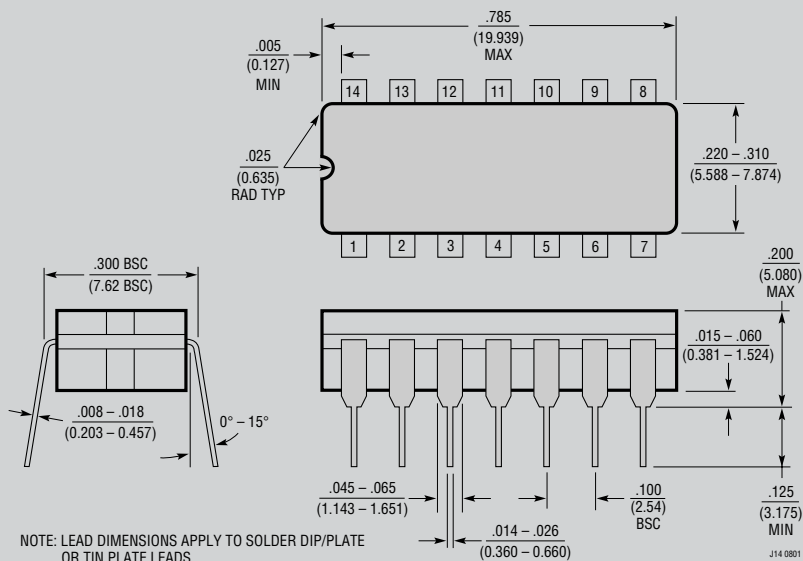

OBsolete PACKAGE

PACKAGE DESCRIPTION

N Package
14-Lead PDIP (Narrow .300 Inch)
 (Reference LTC DWG # 05-08-1510)

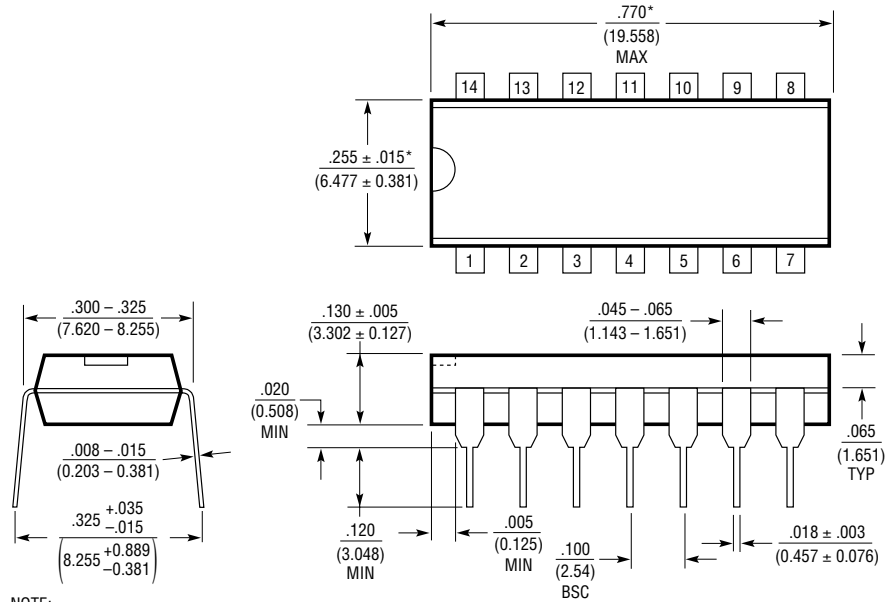

NOTE:
 1. DIMENSIONS ARE $\frac{\text{INCHES}}{\text{MILLIMETERS}}$
 *THESE DIMENSIONS DO NOT INCLUDE MOLD FLASH OR PROTRUSIONS.
 MOLD FLASH OR PROTRUSIONS SHALL NOT EXCEED .010 INCH (0.254mm)

N14 1002

S Package
14-Lead Plastic Small Outline (Narrow .150 Inch)
 (Reference LTC DWG # 05-08-1610)

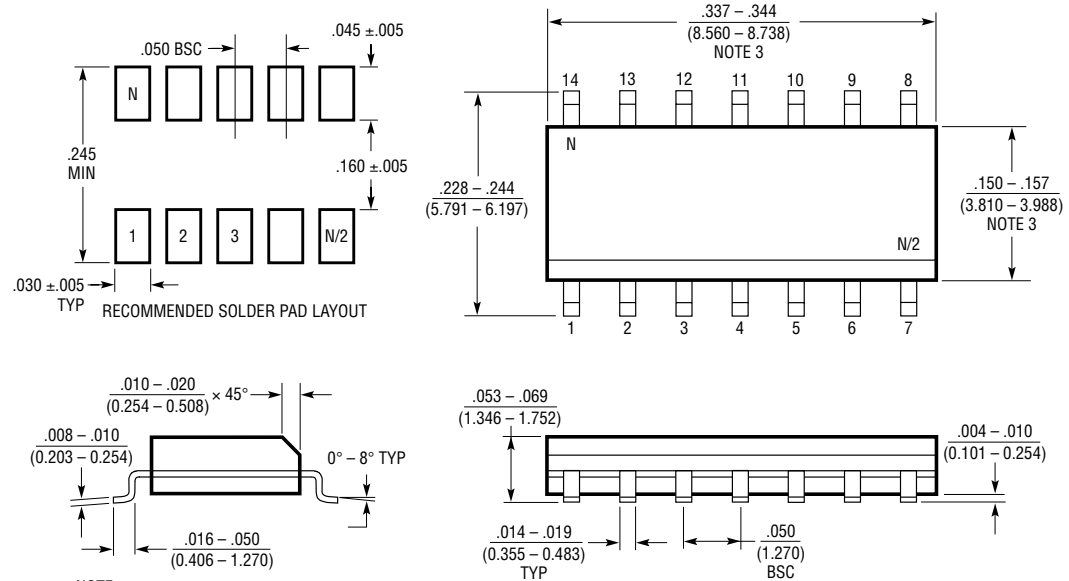

.030 ± .005 TYP
 RECOMMENDED SOLDER PAD LAYOUT

NOTE:
 1. DIMENSIONS IN $\frac{\text{INCHES}}{\text{MILLIMETERS}}$
 2. DRAWING NOT TO SCALE
 3. THESE DIMENSIONS DO NOT INCLUDE MOLD FLASH OR PROTRUSIONS.
 MOLD FLASH OR PROTRUSIONS SHALL NOT EXCEED .006" (0.15mm)

S14 0502



Компания «ЭлектроПласт» предлагает заключение долгосрочных отношений при поставках импортных электронных компонентов на взаимовыгодных условиях!

Наши преимущества:

- Оперативные поставки широкого спектра электронных компонентов отечественного и импортного производства напрямую от производителей и с крупнейших мировых складов;
- Поставка более 17-ти миллионов наименований электронных компонентов;
- Поставка сложных, дефицитных, либо снятых с производства позиций;
- Оперативные сроки поставки под заказ (от 5 рабочих дней);
- Экспресс доставка в любую точку России;
- Техническая поддержка проекта, помощь в подборе аналогов, поставка прототипов;
- Система менеджмента качества сертифицирована по Международному стандарту ISO 9001;
- Лицензия ФСБ на осуществление работ с использованием сведений, составляющих государственную тайну;
- Поставка специализированных компонентов (Xilinx, Altera, Analog Devices, Intersil, Interpoint, Microsemi, Aeroflex, Peregrine, Syfer, Eurofarad, Texas Instrument, Miteq, Cobham, E2V, MA-COM, Hittite, Mini-Circuits, General Dynamics и др.);

Помимо этого, одним из направлений компании «ЭлектроПласт» является направление «Источники питания». Мы предлагаем Вам помощь Конструкторского отдела:

- Подбор оптимального решения, техническое обоснование при выборе компонента;
- Подбор аналогов;
- Консультации по применению компонента;
- Поставка образцов и прототипов;
- Техническая поддержка проекта;
- Защита от снятия компонента с производства.



Как с нами связаться

Телефон: 8 (812) 309 58 32 (многоканальный)

Факс: 8 (812) 320-02-42

Электронная почта: org@eplast1.ru

Адрес: 198099, г. Санкт-Петербург, ул. Калинина, дом 2, корпус 4, литера А.