

ABSOLUTE MAXIMUM RATINGS

(Note 1)

Supply Voltage	18V
Power Dissipation	500mW
Operating Temperature Range	
LTC1059C	$-40^{\circ}\text{C} \leq T_A \leq 85^{\circ}\text{C}$
LTC1059AM, LTC1059M	$-55^{\circ}\text{C} \leq T_A \leq 125^{\circ}\text{C}$
Storage Temperature Range	-65°C to 150°C
Lead Temperature (Soldering, 10 sec)	300°C

PACKAGE/ORDER INFORMATION

TOP VIEW		ORDER PART NUMBER
BP [1]	14 LP	LTC1059CN LTC1059CS
N/AP/HP [2]	13 V _{O2}	
INV1 [3]	12 INV2	
S1 [4]	11 AGND	
S _A [5]	10 V ⁻	
V ⁺ [6]	9 50/100/HOLD	
LSh [7]	8 CLK	
<p>N PACKAGE 14-LEAD PDIP S PACKAGE 14-LEAD PLASTIC SO</p> <p>T_{JMAX} = 110°C, θ_{JA} = 130°C/W (N) T_{JMAX} = 110°C, θ_{JA} = 110°C/W (S)</p>		LTC1059ACJ LTC1059AMJ LTC1059CJ LTC1059MJ
<p>J PACKAGE 14-LEAD CERDIP</p> <p>T_{JMAX} = 150°C, θ_{JA} = 80°C/W</p>		
<p>OBsolete PACKAGE Consider the N or S Package for Alternate Source</p>		

Consult LTC Marketing for parts specified with wider operating temperature ranges.

ELECTRICAL CHARACTERISTICS

The ● denotes the specifications which apply over the full operating temperature range, otherwise specifications are at T_A = 25°C.

(Complete Filter) V_S = ±5V, T²L clock input level unless otherwise specified.

PARAMETER	CONDITIONS	MIN	TYP	MAX	UNITS
Center Frequency Range, f ₀	f ₀ • Q ≤ 400kHz, Mode 1		0.1 - 40k		Hz
	f ₀ • Q ≤ 1.6MHz, Mode 1		0.1 - 18k		Hz
	f ₀ • Q ≤ 250kHz, Mode 3, V _S = ±7.5V		0.1 - 20k		Hz
	f ₀ • Q ≤ 1MHz, Mode 3, V _S = ±7.5V		0.1 - 16k		Hz
Input Frequency Range			0 - 200k		Hz
Clock-to-Center Frequency Ratio	Mode 1, 50:1, f _{CLK} = 250kHz, Q = 10	●		50 ± 0.8%	
	Mode 1, 100:1, f _{CLK} = 500kHz, Q = 10	●		100 ± 0.8%	
Q Accuracy	Mode 1, 50:1 or 100:1, f ₀ = 5kHz Q = 10	●	±0.5	5	%
f ₀ Temperature Coefficient	Mode 1, f _{CLK} < 500kHz		5		ppm/°C
Q Temperature Coefficient	Mode 1, f _{CLK} < 500kHz, Q = 10		15		ppm/°C
DC Offset	V _{OS1}	●	2	15	mV
	V _{OS2}	●	3	30	mV
	V _{OS2}	●	3	40	mV
	V _{OS2}	●	6	60	mV
	V _{OS2}	●	6	80	mV
	V _{OS2}	●	2	20	mV
	V _{OS2}	●	2	30	mV
	V _{OS2}	●	4	40	mV
	V _{OS2}	●	4	60	mV
	V _{OS3}	●	2	20	mV
	V _{OS3}	●	2	30	mV
	V _{OS3}	●	4	40	mV
	V _{OS3}	●	4	60	mV

ELECTRICAL CHARACTERISTICS

The ● denotes the specifications which apply over the full operating temperature range, otherwise specifications are at $T_A = 25^\circ\text{C}$.

(Complete Filter) $V_S = \pm 5\text{V}$, $T^2\text{L}$ Clock Input Level unless otherwise specified.

PARAMETER	CONDITIONS	MIN	TYP	MAX	UNITS
DC Lowpass Gain Accuracy	Mode 1, $R_1 = R_2 = 50\text{k}\Omega$	●	± 0.1	2	%
BP Gain Accuracy at f_0	Mode 1, $Q = 10$, $f_0 = 5\text{kHz}$		± 0.1		%
Clock Feedthrough	$f_{\text{CLK}} \leq 1\text{MHz}$		10		mV
Max Clock Frequency	Mode 1, $Q < 5$, $V_S \geq \pm 5\text{V}$		2		MHz
Power Supply Current		●	3.5	5.5 7	mA mA

(Complete Filter) $V_S = \pm 2.37\text{V}$ unless otherwise specified.

PARAMETER	CONDITIONS	MIN	TYP	MAX	UNITS
Center Frequency Range	$f_0 \cdot Q \leq 120\text{kHz}$, Mode 1, 50:1 $f_0 \cdot Q \leq 120\text{kHz}$, Mode 3, 50:1		0.1 - 12k 0.1 - 10k		Hz Hz
Input Frequency Range			60k		Hz
Clock-to-Center Frequency Ratio	Mode 1, 50:1, $f_{\text{CLK}} = 250\text{kHz}$, $Q = 10$ Mode 1, 100:1, $f_{\text{CLK}} = 250\text{kHz}$, $Q = 10$		$50 \pm 0.8\%$ $100 \pm 0.8\%$		
Q Accuracy	Mode 1, $f_{\text{CLK}} = 250\text{kHz}$, $Q = 10$ 50:1 and 100:1		± 2		%
Max Clock Frequency			700		kHz
Power Supply Current			1.5	2.5	mA

(Internal Op Amps) The ● denotes the specifications which apply over the full operating temperature range, otherwise specifications are at $T_A = 25^\circ\text{C}$.

PARAMETER	CONDITIONS	MIN	TYP	MAX	UNITS
Supply Voltage Range		± 2.375		± 8	V
Voltage Swings	$V_S = \pm 5\text{V}$, $R_L = 5\text{k}$ (Pins 1, 14) $R_L = 3.5\text{k}$ (Pins 2, 13)	●	± 3.8 ± 3.6	± 4.2	V V
Input Offset Voltage		●	1	15	mV
Input Bias Current			3		pA
Output Short-Circuit Current Source/Sink	$V_S = \pm 5\text{V}$ (N Package) $V_S = \pm 5\text{V}$ (S Package)		40/3 25/3		mA mA
DC Open Loop Gain	$V_S = \pm 5\text{V}$		80		dB
GBW	$V_S = \pm 5\text{V}$		2		MHz
Slew Rate	$V_S = \pm 5\text{V}$		7		V/ μs

Note 1: Absolute Maximum Ratings are those values beyond which the life of a device may be impaired.

TYPICAL PERFORMANCE CHARACTERISTICS

**Graph 1. Mode 1:
(f_{CLK}/f_0) Deviation vs Q**

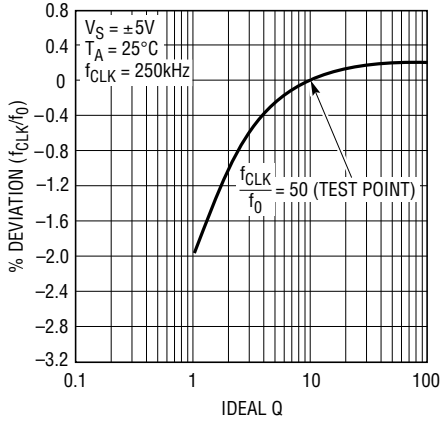

**Graph 2. Mode 1:
(f_{CLK}/f_0) Deviation vs Q**

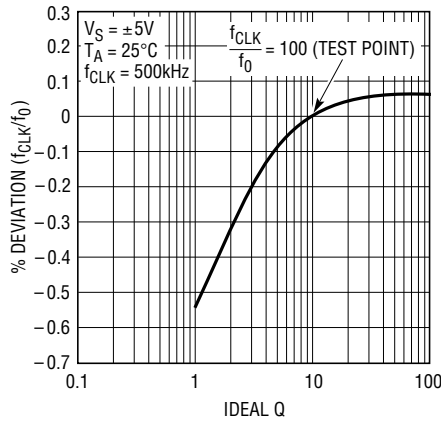

**Graph 3. Mode 1: Q Error
vs Clock Frequency**

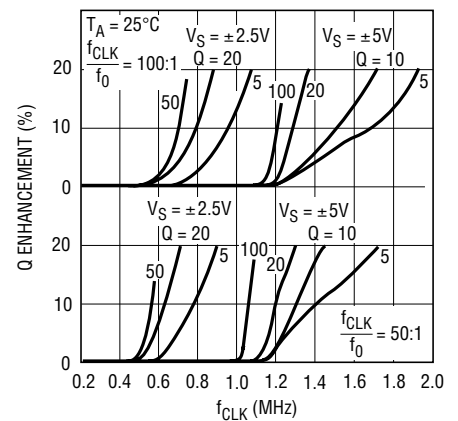

**Graph 4. Mode 1: Q Error
vs Clock Frequency**

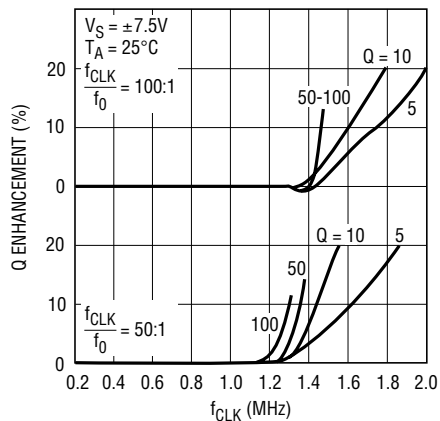

**Graph 5. Mode 1: Measured Q
vs f_{CLK} and Temperature**

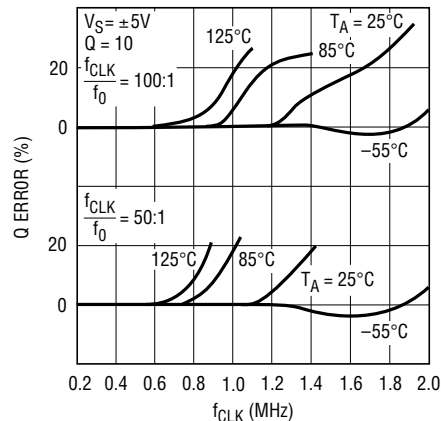

**Graph 6. Mode 1: (f_{CLK}/f_0)
vs f_{CLK} and Q**

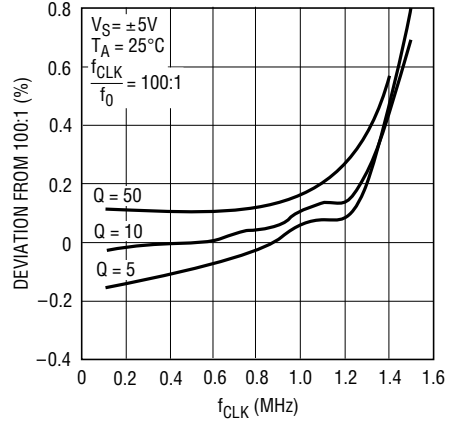

**Graph 7. Mode 1: (f_{CLK}/f_0)
vs f_{CLK} and Q**

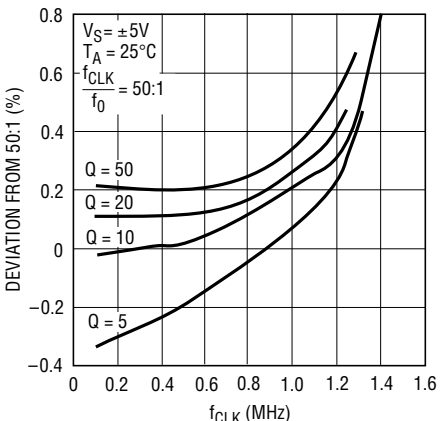

**Graph 8. Mode 1: (f_{CLK}/f_0)
vs f_{CLK} and Temperature**

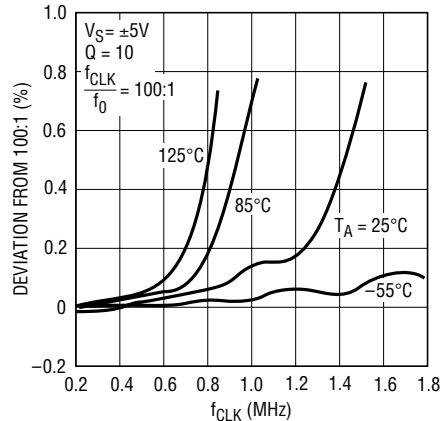

**Graph 9. Mode 1: (f_{CLK}/f_0)
vs f_{CLK} and Temperature**

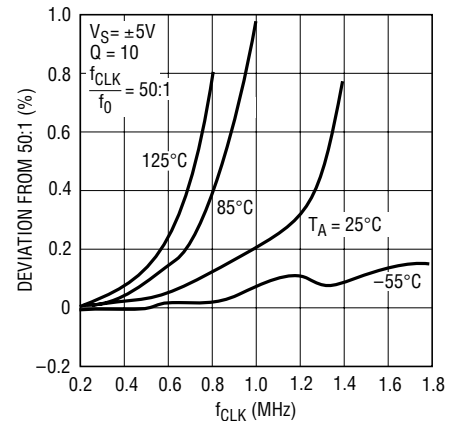

TYPICAL PERFORMANCE CHARACTERISTICS

Graph 10. Mode 1: (f_{CLK}/f_0) vs f_{CLK} and Q

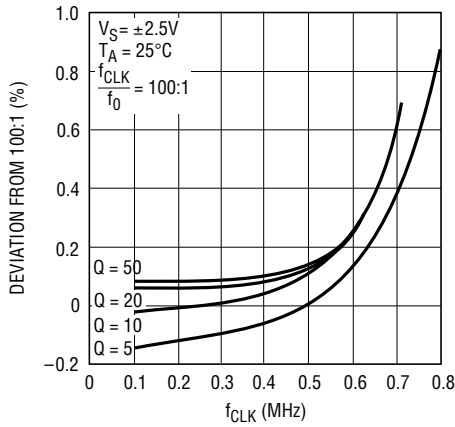

1059 G10

Graph 11. Mode 1: (f_{CLK}/f_0) vs f_{CLK} and Q

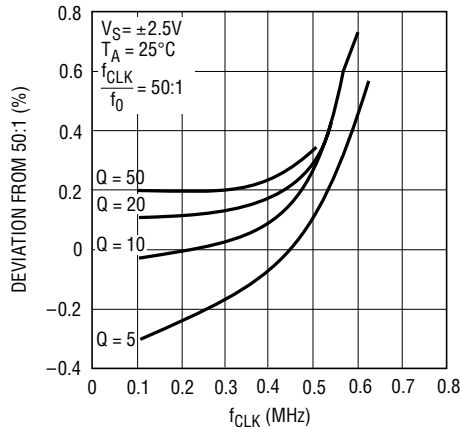

1059 G11

Graph 12. Mode 1: (f_{CLK}/f_0) vs f_{CLK} and Temperature

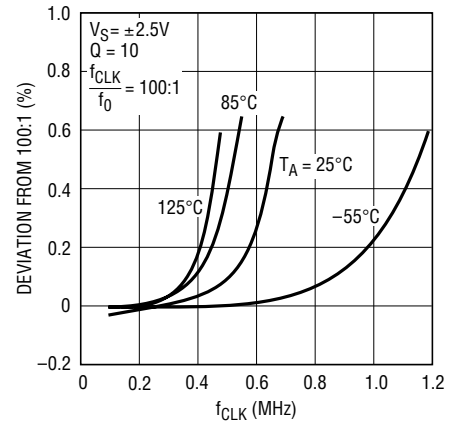

1059 • G12

Graph 13. Mode 1: (f_{CLK}/f_0) vs f_{CLK} and Temperature

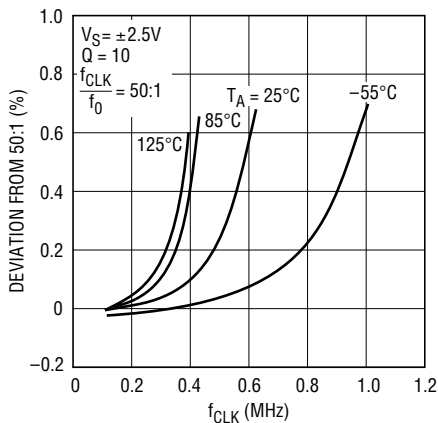

1059 G13

Graph 14. Mode 1: Notch Depth vs Clock Frequency

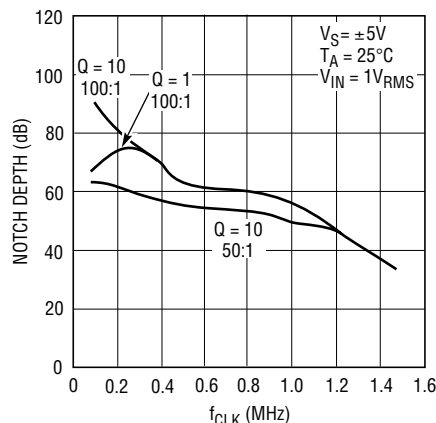

1059 G14

Graph 15. Mode 3: Deviation of (f_{CLK}/f_0) with Respect to Q = 10 Measurement

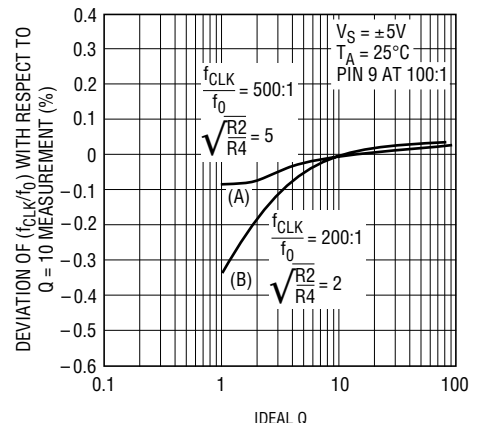

1059 G15

Graph 16. Mode 3: Q Error vs Clock Frequency

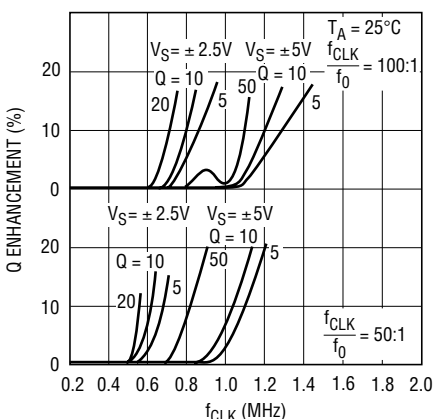

1059 G16

Graph 17. Mode 3 (R2 = R4): Q Error vs Clock Frequency

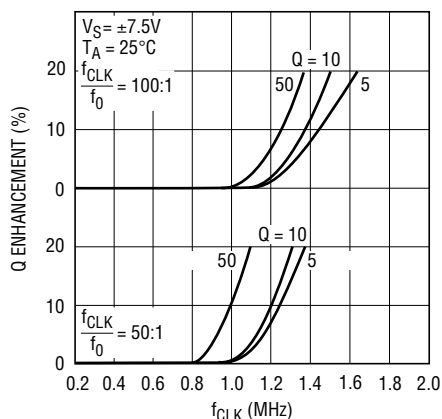

1059 G17

Graph 18. Mode 3 (R2 = R4): Measured Q vs f_{CLK} and Temperature

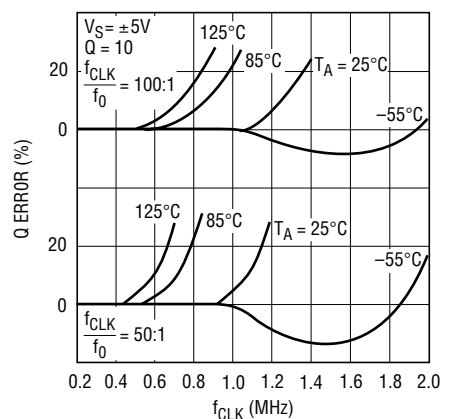

1059 G18

1059fd

TYPICAL PERFORMANCE CHARACTERISTICS

**Graph 19. Mode 3 (R2 = R4):
(f_{CLK}/f₀) vs f_{CLK} and Q**

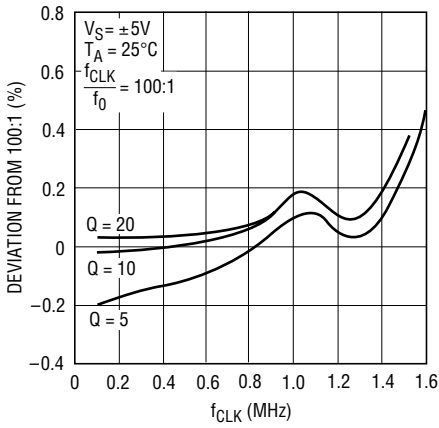

1059 G19

**Graph 20. Mode 3 (R2 = R4):
(f_{CLK}/f₀) vs f_{CLK} and Q**

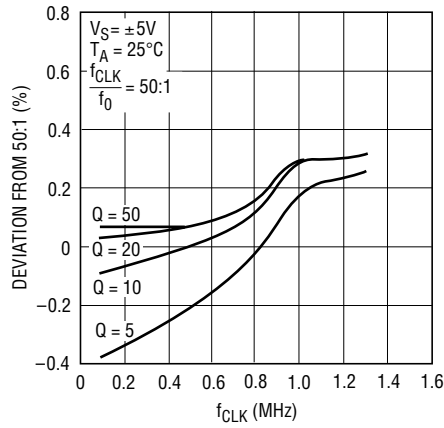

1059 G20

**Graph 21. Mode 3 (R2 = R4):
(f_{CLK}/f₀) vs f_{CLK} and Temperature**

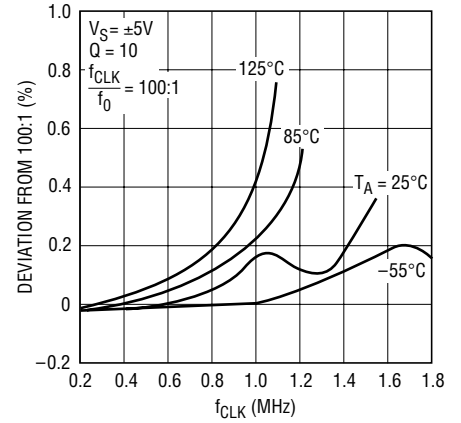

1059 G21

**Graph 22. Mode 3 (R2 = R4):
(f_{CLK}/f₀) vs f_{CLK} and Temperature**

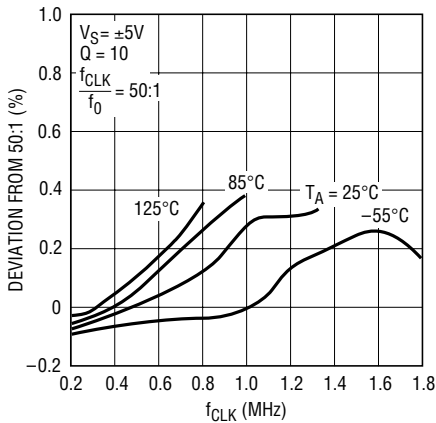

1059 G22

**Graph 23. Mode 3 (R2 = R4):
(f_{CLK}/f₀) vs f_{CLK} and Temperature**

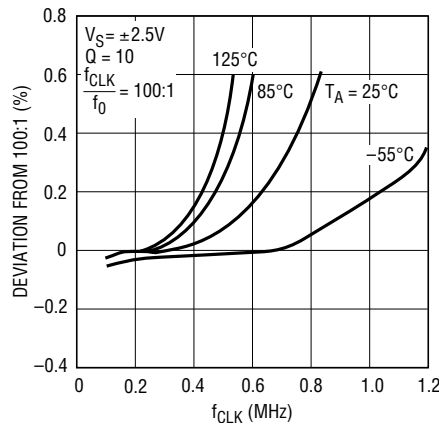

1059 G23

**Graph 24. Mode 3 (R2 = R4):
(f_{CLK}/f₀) vs f_{CLK} and Temperature**

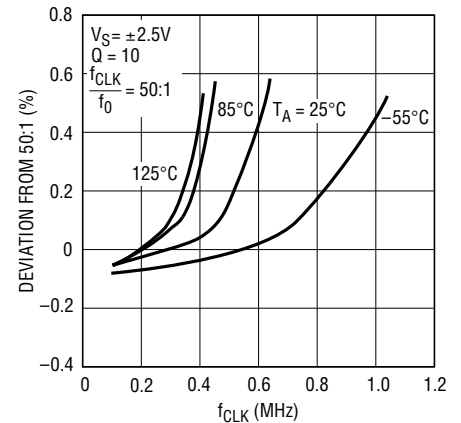

1059 G24

**Graph 25. Mode 1c (R5 = 0),
Mode 2 (R2 = R4): Q Error vs
Clock Frequency**

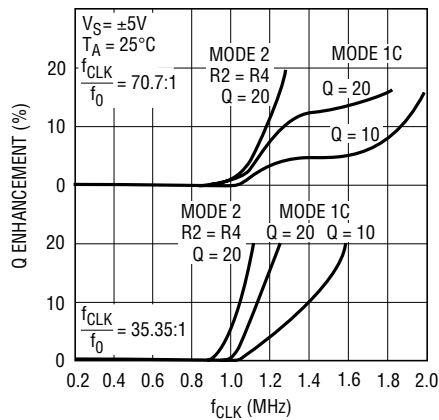

1059 G25

**Graph 26. Supply Current
vs Supply Voltage**

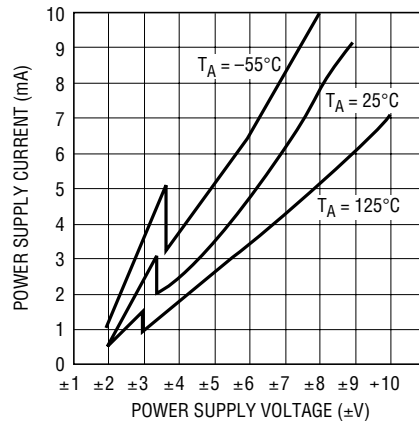

1059 G26

1059fd

BLOCK DIAGRAM

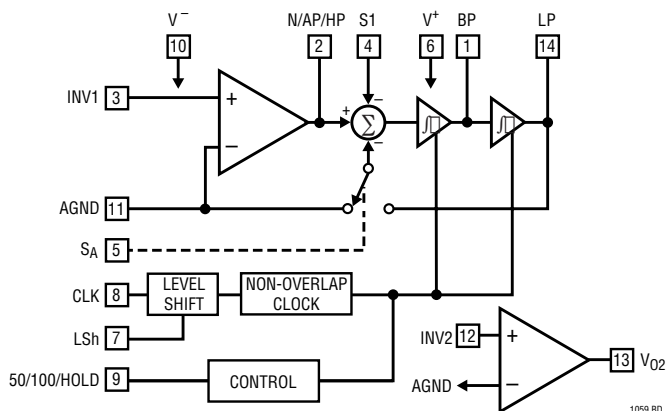

APPLICATIONS INFORMATION

The LTC1059 is compatible with the LTC1060. All the LTC1059 pins are functionally equivalent to the LTC1060 pins bearing the same title. For a detailed pin description and definition of various modes of operation refer to the LTC1060 data sheet. The LTC1059 is typically “faster” than the LTC1060 especially under single 5V (or $\pm 2.5V$) supply

operation. This becomes apparent through the Typical Performance Characteristics of the part. All the graphs shown in this data sheet have been drawn under the same test conditions as in the LTC1060 data sheet; they are also numbered in the same order. For complete discussion of the filter characteristics see the LTC1060 data sheet.

PACKAGE DESCRIPTION

J Package
14-Lead CERDIP (Narrow .300 Inch, Hermetic)
 (Reference LTC DWG # 05-08-1110)

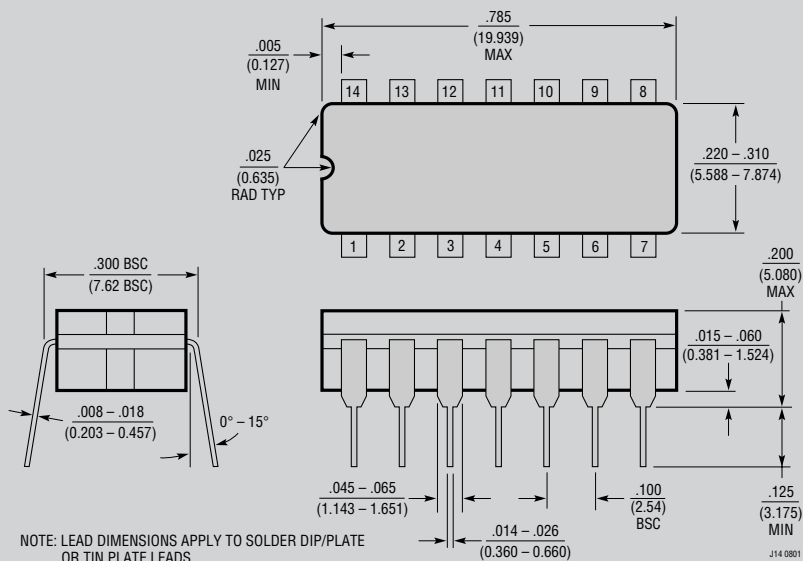

OBsolete PACKAGE

PACKAGE DESCRIPTION

N Package 14-Lead PDIP (Narrow .300 Inch) (Reference LTC DWG # 05-08-1510)

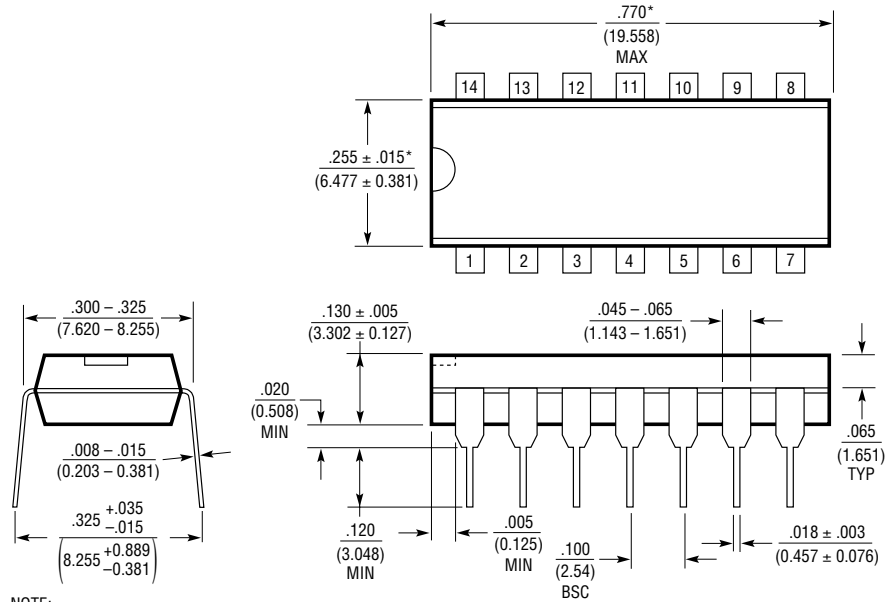

NOTE:
1. DIMENSIONS ARE $\frac{\text{INCHES}}{\text{MILLIMETERS}}$
*THESE DIMENSIONS DO NOT INCLUDE MOLD FLASH OR PROTRUSIONS.
MOLD FLASH OR PROTRUSIONS SHALL NOT EXCEED .010 INCH (0.254mm)

N14 1002

S Package 14-Lead Plastic Small Outline (Narrow .150 Inch) (Reference LTC DWG # 05-08-1610)

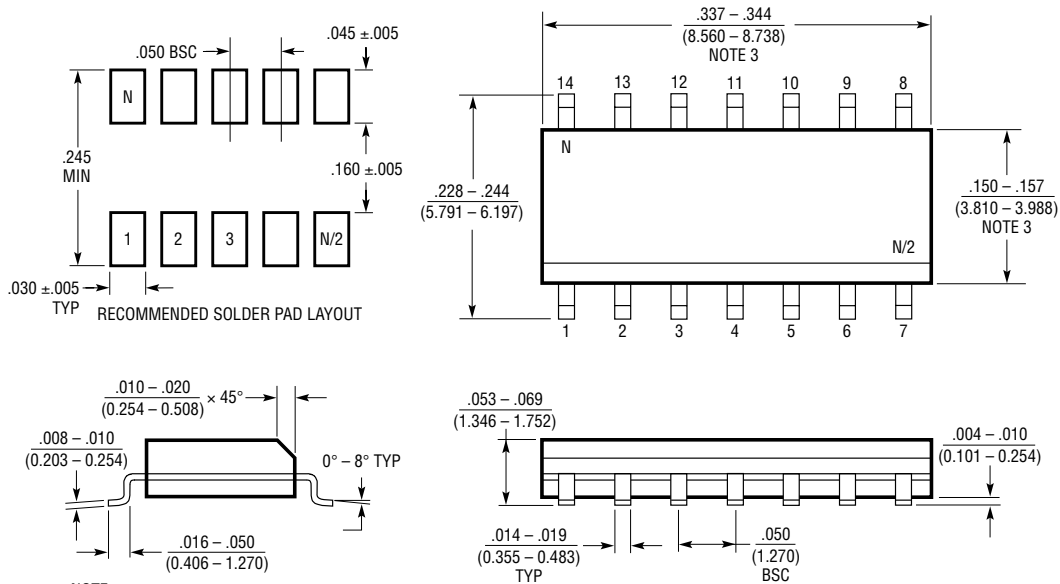

NOTE:
1. DIMENSIONS IN $\frac{\text{INCHES}}{\text{MILLIMETERS}}$
2. DRAWING NOT TO SCALE
3. THESE DIMENSIONS DO NOT INCLUDE MOLD FLASH OR PROTRUSIONS.
MOLD FLASH OR PROTRUSIONS SHALL NOT EXCEED .006" (0.15mm)

S14 0502



Компания «ЭлектроПласт» предлагает заключение долгосрочных отношений при поставках импортных электронных компонентов на взаимовыгодных условиях!

Наши преимущества:

- Оперативные поставки широкого спектра электронных компонентов отечественного и импортного производства напрямую от производителей и с крупнейших мировых складов;
- Поставка более 17-ти миллионов наименований электронных компонентов;
- Поставка сложных, дефицитных, либо снятых с производства позиций;
- Оперативные сроки поставки под заказ (от 5 рабочих дней);
- Экспресс доставка в любую точку России;
- Техническая поддержка проекта, помощь в подборе аналогов, поставка прототипов;
- Система менеджмента качества сертифицирована по Международному стандарту ISO 9001;
- Лицензия ФСБ на осуществление работ с использованием сведений, составляющих государственную тайну;
- Поставка специализированных компонентов (Xilinx, Altera, Analog Devices, Intersil, Interpoint, Microsemi, Aeroflex, Peregrine, Syfer, Eurofarad, Texas Instrument, Miteq, Cobham, E2V, MA-COM, Hittite, Mini-Circuits, General Dynamics и др.);

Помимо этого, одним из направлений компании «ЭлектроПласт» является направление «Источники питания». Мы предлагаем Вам помощь Конструкторского отдела:

- Подбор оптимального решения, техническое обоснование при выборе компонента;
- Подбор аналогов;
- Консультации по применению компонента;
- Поставка образцов и прототипов;
- Техническая поддержка проекта;
- Защита от снятия компонента с производства.



Как с нами связаться

Телефон: 8 (812) 309 58 32 (многоканальный)

Факс: 8 (812) 320-02-42

Электронная почта: org@eplast1.ru

Адрес: 198099, г. Санкт-Петербург, ул. Калинина, дом 2, корпус 4, литера А.