

Product Range

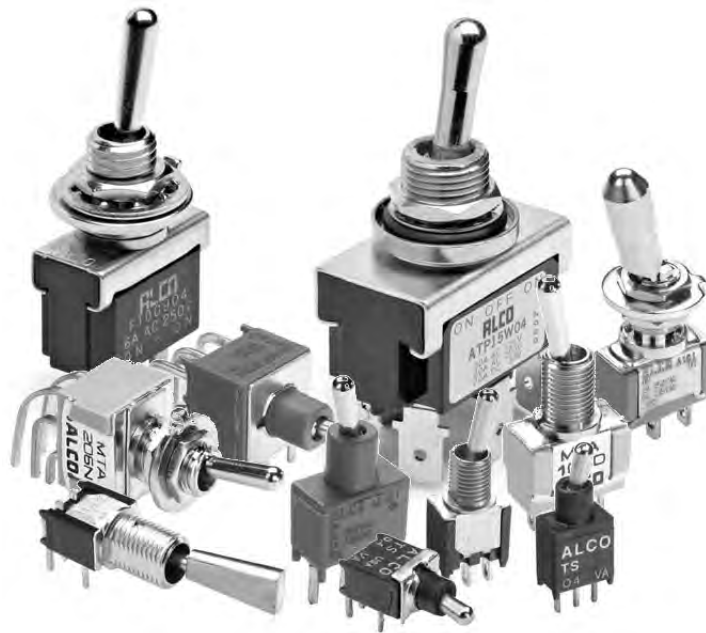

Toggle Switches

Toggle Switches

- **Tiny Toggles:** TT and TST Series
- **Miniature Toggles:** Gemini Series and Green Series
- **Power Toggles:** F and AW Series

Main features:

- Up to 4 poles
- Wide range of different switch functions
- Gold or silver contacts
- Up to 20 A
- Sealed or unsealed versions
- Horizontal and vertical right angle versions
- Many different actuator styles
- Locking versions
- Different bushings with or with out thread
- THT and wire lug terminals
- Accessories: Boot seals, decorative mounting hardware

TST Tiny Toggle, Process Sealedpage E3



TT Tiny Toggle Switchpage E6



Product Range (Continued)



Gemini A Seriespage E15



Gemini AE Series, Sealed IP67page E26



MT Green Seriespage E32



F Series, Panel Mounting, 6Apage E43



AW Series, Panel Mounting, Waterproofpage E46



Hardware and Accessoriespage E49



Boot Sealspage E50

TST, Tiny Toggle, Process Sealed

Features

- Washable process sealed construction (Internal "O" ring)
- Compact design
- Liquid Crystal Polymer (LCP) case



Typical performance characteristics

Contact configuration spst, spdt
 Contact timing break-before-make
 Contact rating, max gold 0.4 VA @ 20 VAC/DC
 Electrical life D = 80,000 cycles (2 position)
 E = 60,000 cycles (3 position)
 F and G = 30,000 cycles (momentary 2 and 3 position)
 Contact resistance, initial max.20 mOhms
 Insulation resistance 1,000 mega Ohms @ 500 VDC
 Dielectric strength 1,000 Vrms @ sea Level
 Actuator travel 22° for D and E function
 18° for F and G function

Environmental specification

Operating temperature -30°C to +85°C
 Storage temperature -55°C to +85°C
 Solder heat resistance wave solder capable to 265°C
 Seal process sealed with internal "O" ring

Material specifications

Contacts copper or brass alloy, gold over nickel finish
 Bat brass alloy, nickel finish
 Terminals brass with gold over nickel in contact area
 tin over nickel in solder area
 Case theroplastic (LCP)
 Spring music wire zinc plated
 Support bracket steel tin plated
 Seal "O" ring rubber
 RoHS Directive 2002/95/EC compliant

Product key	Typical product key											
	TST	1	1	D	G	RA	1	D	04			
Type	Tiny toggle, process sealed, through hole mount											
Number of Poles	1 single pole											
Contact rating	1 0.4VA Gold											
Function	D On None On			F On None (On)								
	E On Off On			G (On) Off (On)								
Plating	G Gold											
Terminals	PC printed circuit board				RA right angle							
	PCV printed circuit board, w bracket				VRA vertical right angle							
Actuator length	1 .206 (5.23)			4 .400 (10.16)								
	2 .250 (6.35)											
Bushing	D plain, not threaded											
Material	04 RoHS compliant											

Toggle Switches

TST, Tiny Toggle, Process Sealed (Continued)

Function



Function			
D	On	None	On
E	On	Off	On
F	On	None	(On)
G	(On)	Off	(On)
Terminals	1-2	-	2-3

Off indicates a mechanical position with no electrical connection
 (On) indicates momentary connection
 None indicates no mechanical position

Terminations



PC printed circuit



TST11DGPC1D

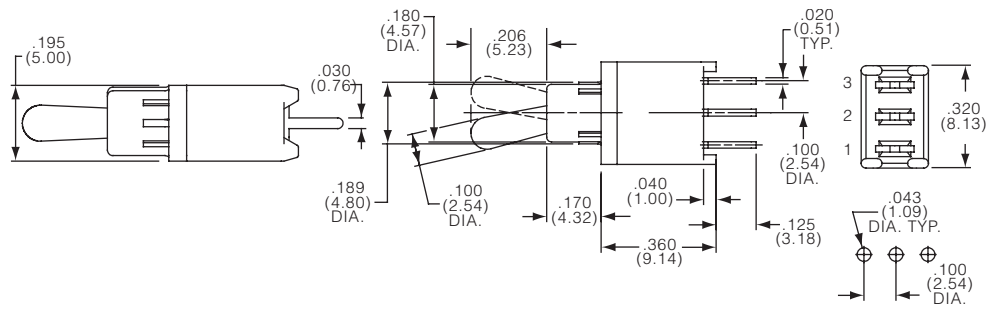

RA right angle



TST11DGRA1D

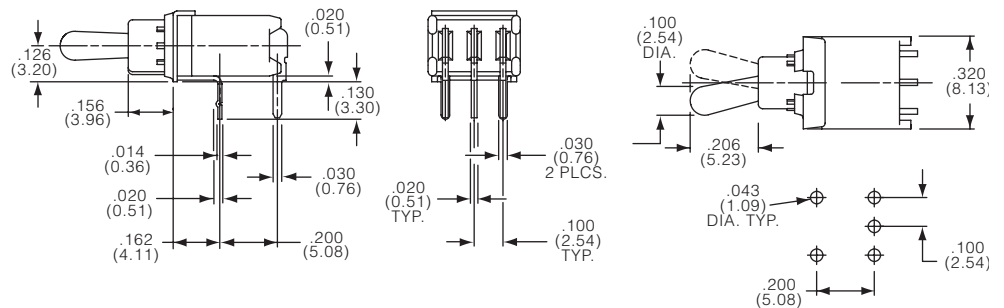

VRA vertical right angle



TST11DGVRA1D

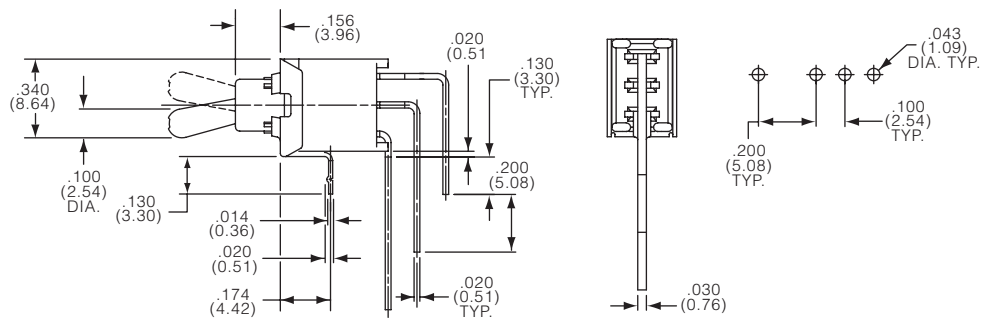

TST, Tiny Toggle, Process Sealed(Continued)

Actuator



Codes 1,2,4 actuator lengths

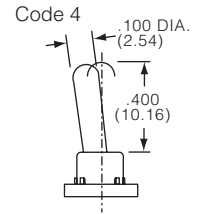
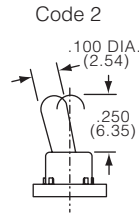
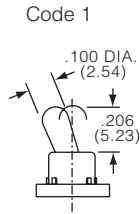

Product key	Poles	Rating	Function	Plating	Terminals	Actuator	Bushing	Material	Part Number
TST11DGPC1D04	1 pole	0.4VA	On None On	Gold	pcb	.206 (5.23)	plain,	RoHS	1825455-1
TST11DGPCV1D04					pcb w brack		not	compliant	1825455-2
TST11DGRA1D04					right angle		threaded		1825455-3
TST11DGVRA1D04					vertical r.a.				1825455-4
TST11EGPC4D04			On Off On		pcb	.400 (10.16)			1825455-5

Preferred parts in bold print

TT, Tiny Toggle Switch

Features

- Compact design
- Vertical and horizontal right angle versions available

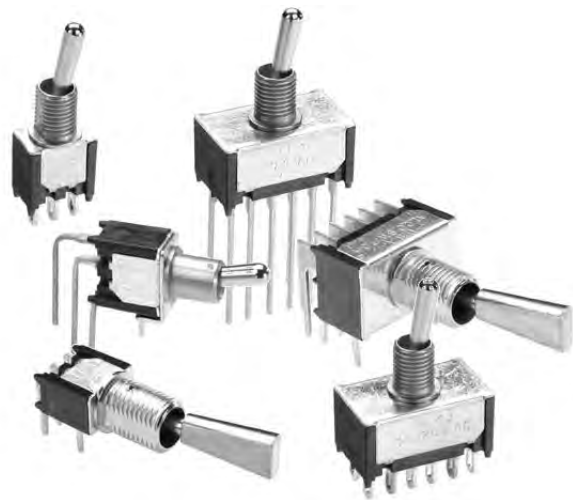

Typical performance characteristics

Contact configuration	1, 2 and 4 pole
Contact timing	make before break
Contact rating, max	gold 0.4 VA @ 20 VDC or peak AC resistive
	silver (2 position): 3 A @ 125 VAC or 28 VDC resistive
	silver (4 position): 2 A @ 125 VAC or 28 VDC resistive
Electrical life	0.4 VA: 80,000 (2 pos.), 60,000 (3 pos.)
	2 A: 10,000 cycles
	3 A: 20,000 cycles
Contact resistance, initial	max.20 mOhms
Insulation resistance	1,000 MOhms @ 500 VDC
Dielectric strength	1,000 Vrms @ sea Level
Actuator travel	22° for D and E function
	18° for F and G function

Environmental specification

Operating temperature	-30°C to +85°C
Storage temperature	-55°C to +85°C
Solder heat resistance	wave solder capable to 265°C
Terminal Seal	single pole: epoxy, double pole: epoxy optional
Process Sealed	TTE version only

Material specifications

Contacts	copper or brass alloy, gold over nickel finish
	or silver clad copper alloy
Actuator	brass alloy, nickel finish or
	stainless steel or thermoplastic
Terminals	brass with gold over nickel in contact area
	brass alloy, gold over nickel finish
	or silver clad copper alloy tin over nickel in solder area
Case	thermoplastic
Bushing	brass alloy finish nickel over copper
Internal actuator	thermoplastic or PTFE
Spring	music wire zinc plated
Support Bracket	steel tin plated
RoHS Directive 2002/95/EC	compliant

TT, Tiny Toggle Switch (Continued)

Product key	Typical product key	TT	1	1	D	G	PC	9	T1/4	04
Type	TT Tiny toggle switch									
Environmental seal	blank no seal E environmental seal (splash proof), not available with actuator 7 or with terminals VRA									
Number of Poles	1 single pole 2 double pole									
Contact rating	1 0.4VA Gold 3 1 Amp, Silver with wire lug and pc terminals only									
Function	single pole A On Off Versions A and K available with wire lug & pc terminals only D On On E On Off On F On (On) 2 & 4 pole K On Off N On On P On Off On R On (On)									
Plating	G Gold blank Silver									
Terminals	blank wire lug PC printed circuit RA right angle VRA vertical right angle WW wire wrap									
Actuator length	#10 or Unthreaded Bushing 1 .221 (5.61), bat 2 .296 (7.52), bat 3 .381 (9.68), bat 5 na 6 .401 (10.19), round, colored 7 na 8 na 9 .516 (13.11), bat 1/4 Bushing 1 .125 (3.18), bat 2 .200 (5.1), bat 3 .286 (7.26), bat 5 paddle 6 .306 (7.77), round, colored 7 .457 (11.61), flat 8 .567 (14.40), locking 9 .421 (10.693), bat									
Bushing	blank unthreaded T #10-48 T1/4 1/4-40									
Actuator color for actuator code 6 only	0 black 2 red 6 blue 9 white									
Material	04 RoHS compliant									

Toggle Switches

Function



Function	Poles	↘	↓	↙	↘	↓	↙
A	1 pole	On	None	Off	1-3	-	-
D		On	None	On	1-2	-	2-3
E		On	Off	On	1-2	-	2-3
F		On	None	(On)	1-2	-	2-3
K	2 poles	On	None	Off	1-3, 4-6	-	-
N		On	None	On	1-2, 4-5	-	2-3, 5-6
P		On	Off	On	1-2, 4-5	-	2-3, 5-6
R		On	None	(On)	1-2, 4-5	-	2-3, 5-6

Off indicates a mechanical position with no electrical connection
 (On) indicates momentary connection
 None indicates no mechanical position

TT, Tiny Toggle Switch (Continued)

Terminals

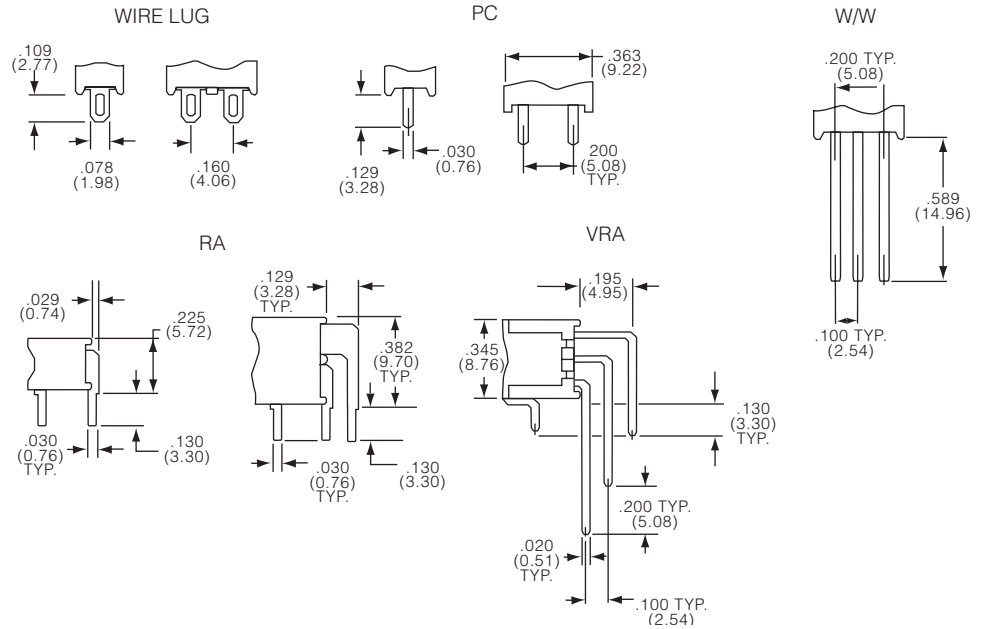

Actuator

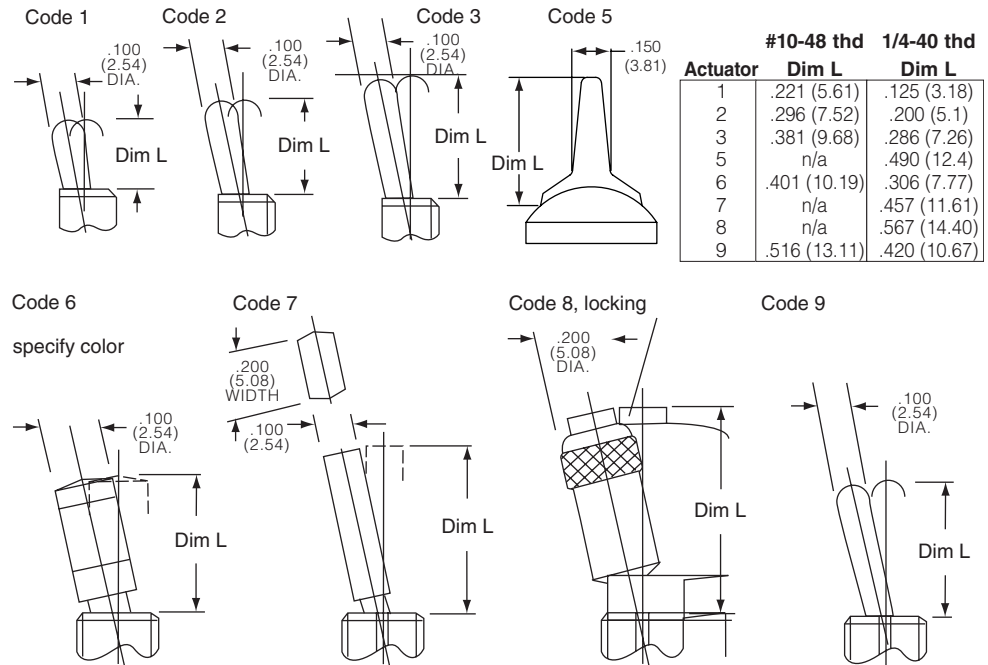

TT, Tiny Toggle Switch (Continued)

Bushing



blank

unthreaded

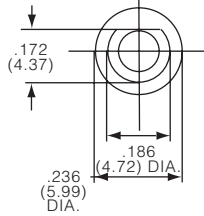
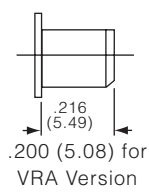

panel cutout

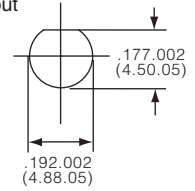

T

10-48 UNS-2A thread

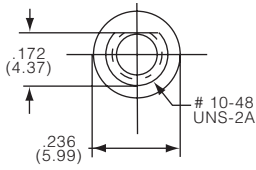
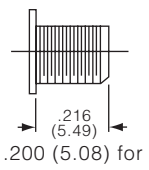

panel cutout

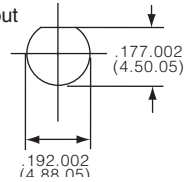

T1/4

1/4-40 UNS-2A thread for non environmental sealed version

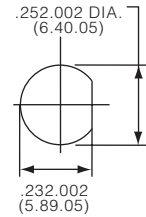
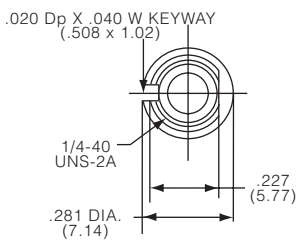
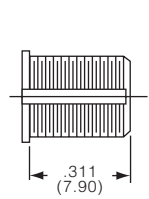

panel cutout

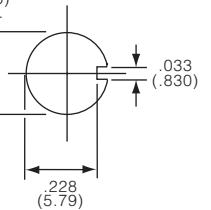

T1/4

1/4-40 UNS-2A thread for environmental sealed version

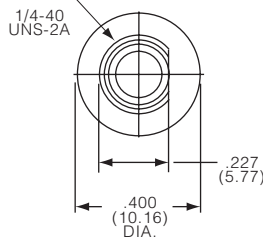
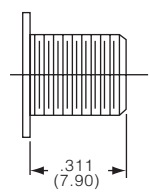

panel cutout

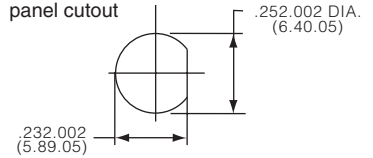

TT, Tiny Toggle Switch (Continued)

Dimensions

Series TT...2T wire lug, .296 bat toggle, 10-48 thread

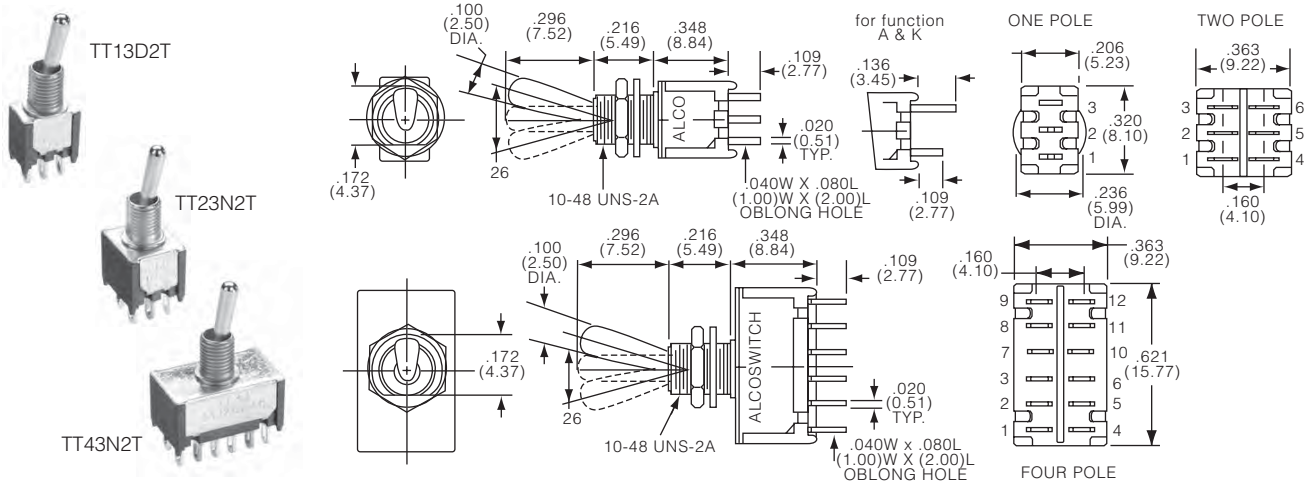

Series TT...3T wire lug, .381 bat toggle, 10-48 thread

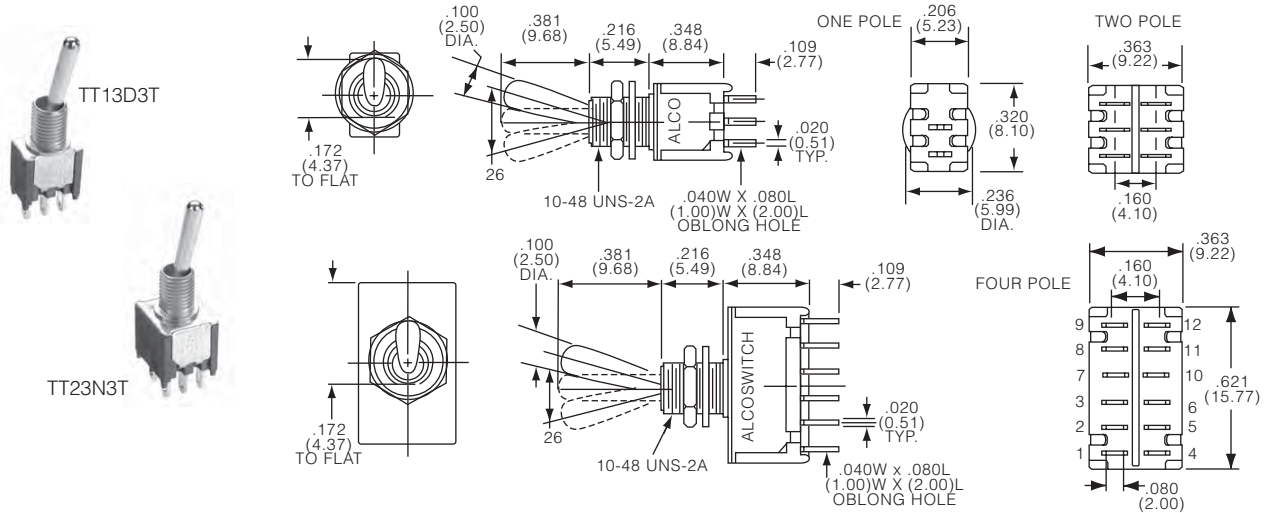

Toggle Switches

TT, Tiny Toggle Switch (Continued)

Series TT...7T1/4 wire lug, .457 flat toggle, 1/4-40 thread

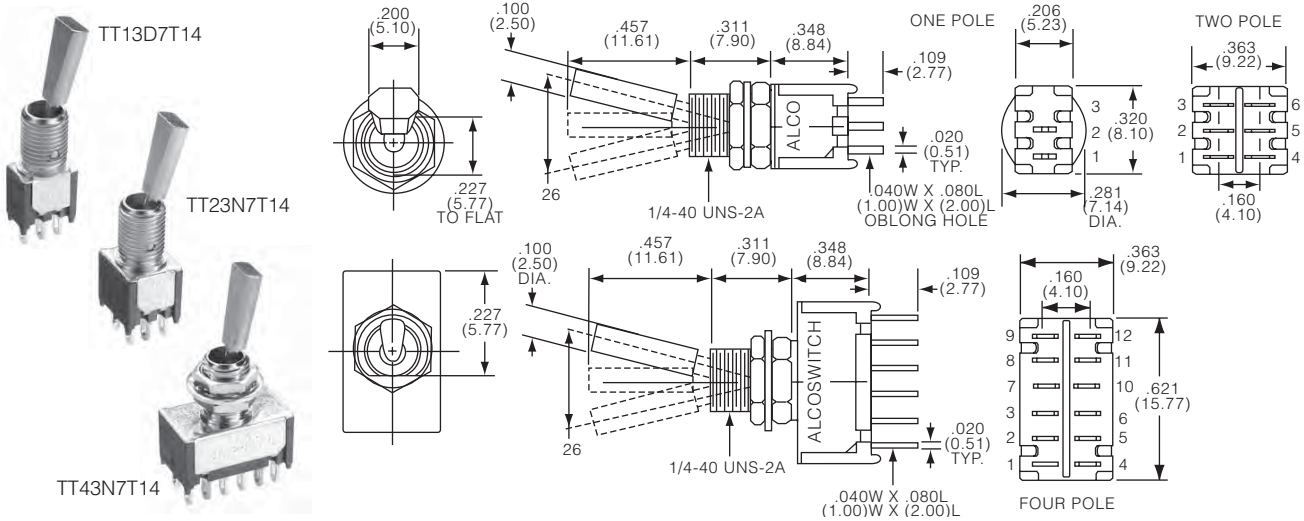

Series TT...9T1/4 wire lug, .420 bat toggle, 1/4-40 thread

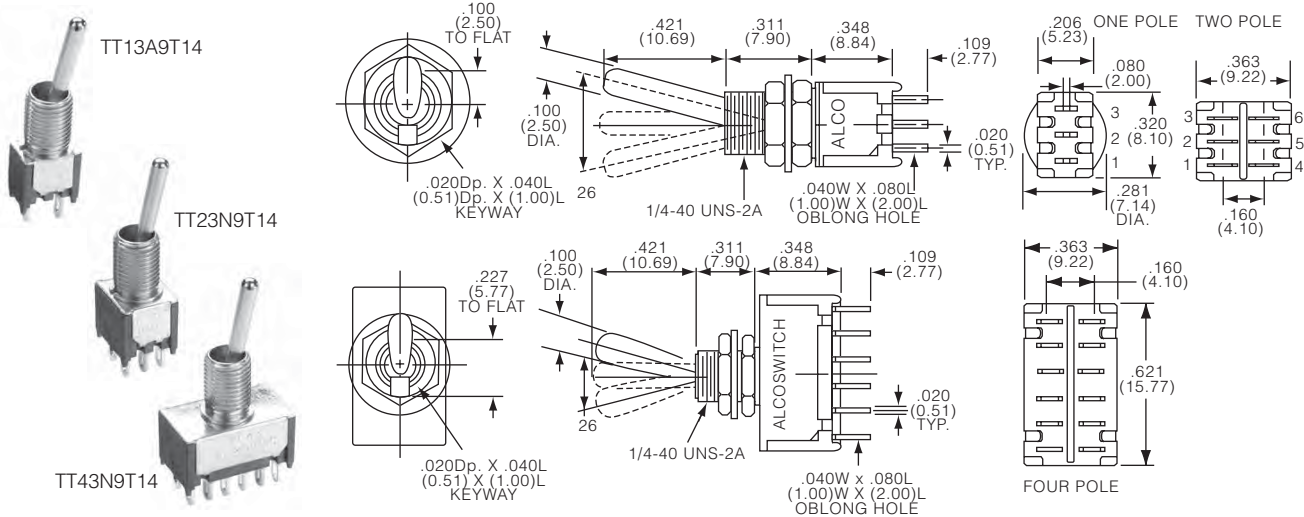

Series TT...PC1 pc terminals, .221 bat toggle, unthreaded

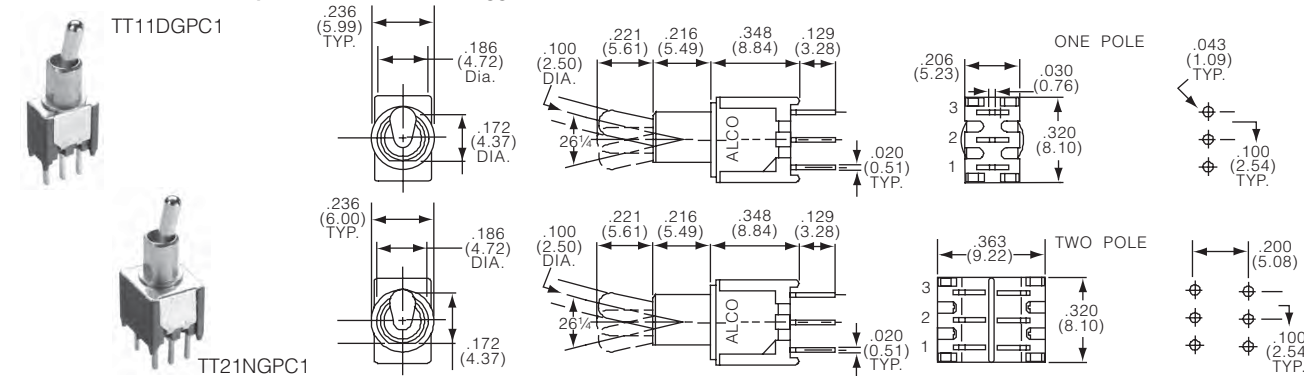

Toggle Switches

TT, Tiny Toggle Switch (Continued)

Series TT...PC1 pc terminals, .221 bat toggle, unthreaded

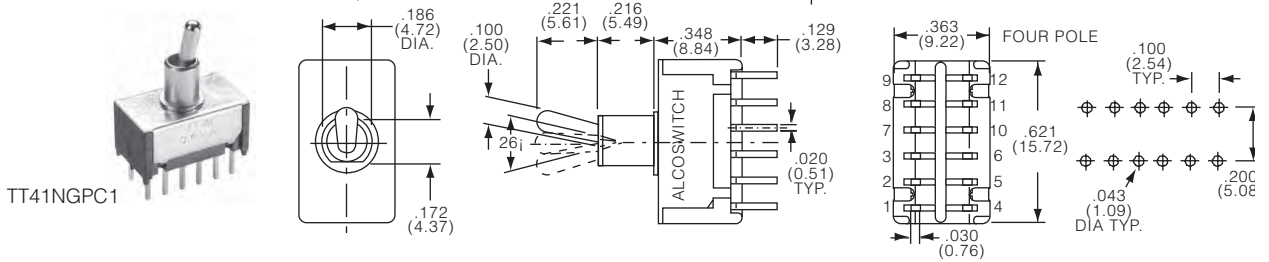

Series TT...PC9T1/4 pc terminals, .420 bat toggle, 1/4-40 thread

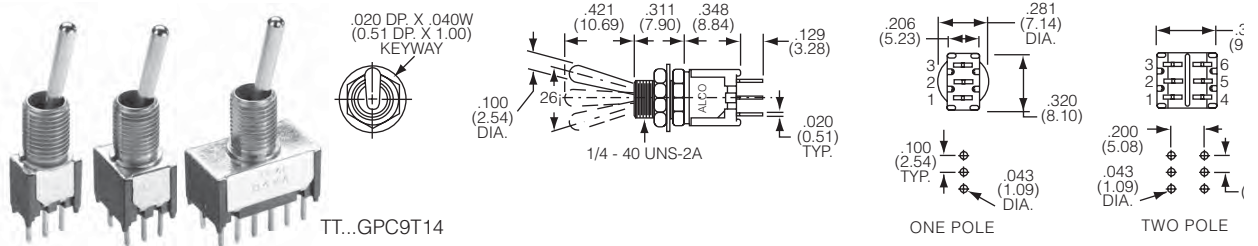

Series TT...RA7T1/4 right angle, .457 flat toggle, 1/4-40 thread

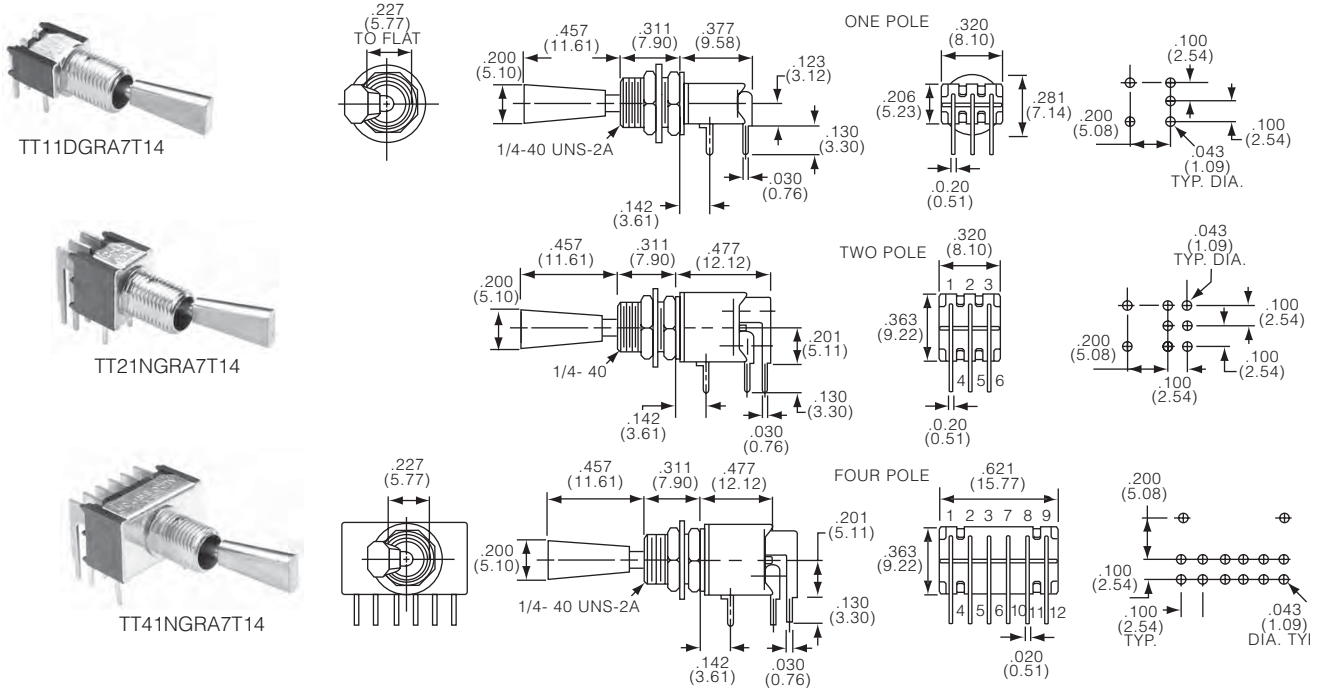

Toggle Switches

TT, Tiny Toggle Switch (Continued)

Series TT...VRA1 vertical right angle, .221 bat toggle, unthreaded

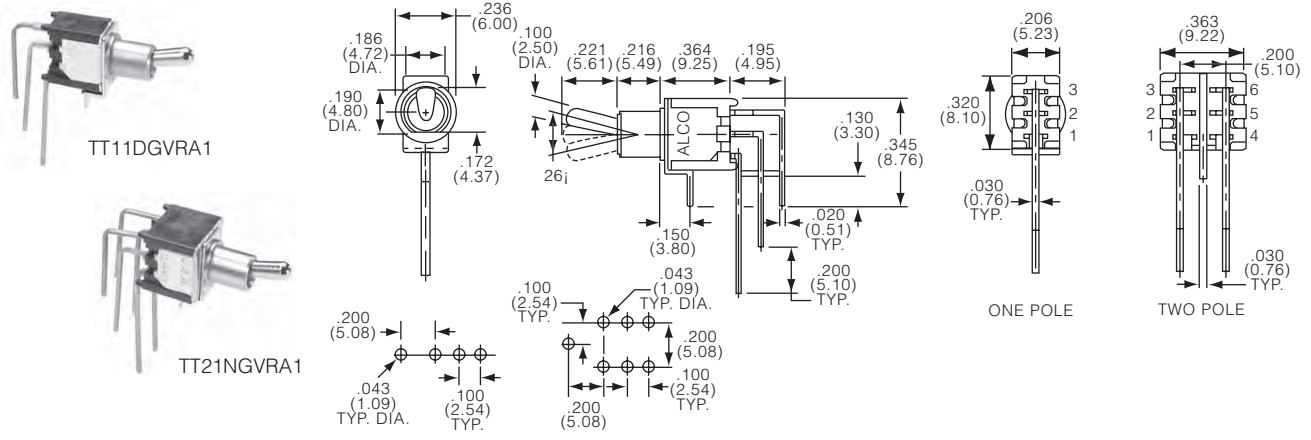

Series TT...VRA3T vertical right angle, .381 bat, 10-48 thread

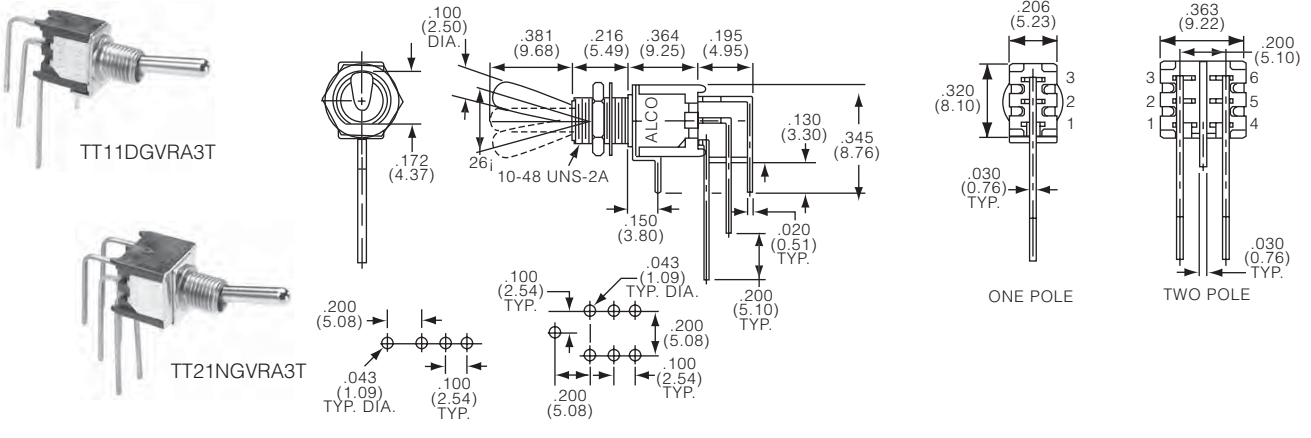

Series TT...WW2T wire wrap, .296 bat toggle, 10-48 thread

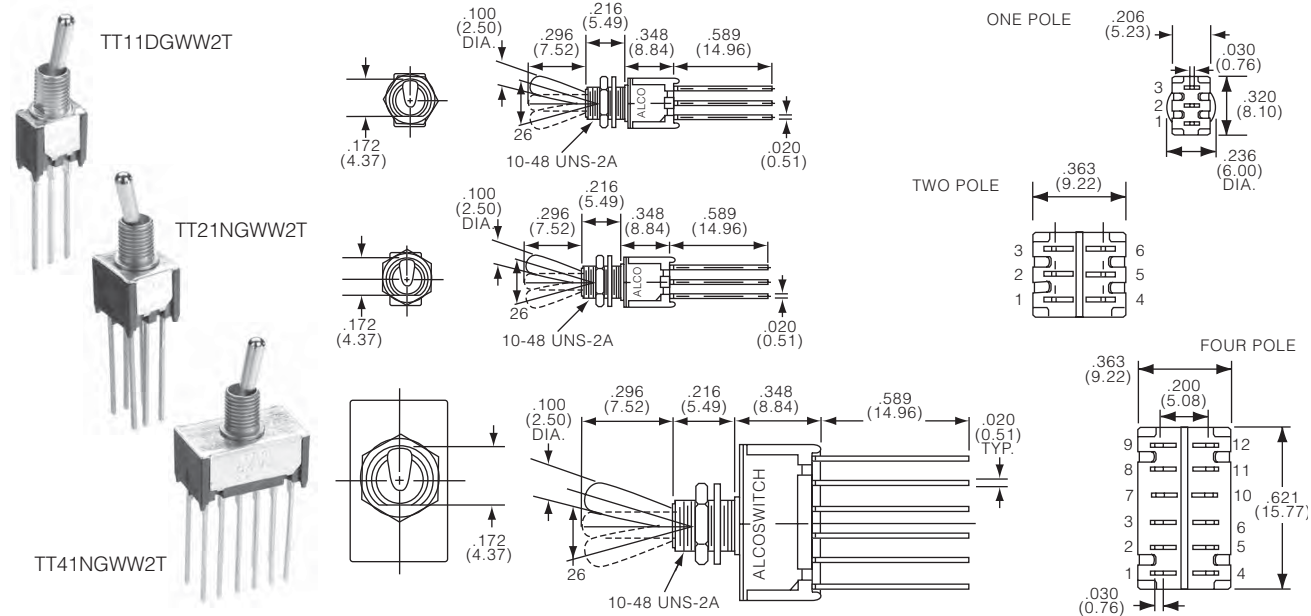

TT, Tiny Toggle Switch (Continued)

Toggle Switches

Product key	E. seal	Poles	Contacts	Function	Terminals	Act. length	Bushing	Material	Part Number
TT11AGPC104	no	1	0.4VA	On Off	pc	.221 (5.61), bat	unthreaded	RoHS compliant	1825219-2
TT11AGPC9T1/404			Gold plated			.421 (10.69), bat	1/4-40		1-1825192-8
TT11DGPC104				On On		.221 (5.61), bat	unthreaded		1825219-3
TT11DGPC7T1/404						.457 (11.61), flat	1/4-40		1825226-1
TT11DGPC9T1/404						.421 (10.69), bat			1825192-2
TT11DGRA104					right a.	.125 (3.18), bat	unthreaded		1825219-4
TT11DGRA7T1/404						.457 (11.61), flat	1/4-40		1825226-2
TT11DGRA9T1/404						.421 (10.69), bat			1825192-3
TT11DGVRA104					vert r.a.	.125 (3.18), bat	unthreaded		1825219-5
TT11DGWW2T04					wire wrap	.200 (5.1), bat	#10-48		1825222-1
TT11EGPC104				On Off On	pc	.125 (3.18), bat	unthreaded		1825219-6
TT11EGPC304						.286 (7.26), bat			1825223-1
TT11EGPC5T1/4004						.490 (12.45)	1/4-40		1825224-1
TT11EGPC9T1/404									1825192-4
TT11EGPCV104					pc vert.	.125 (3.18), bat	unthreaded		1825219-7
TT11EGRA104					right a.				1825219-8
TT11EGVRA104					vert r.a.				1825219-9
TT11EGVRA3T04						.286 (7.26), bat	#10-48		1825223-2
TT11FGRA9T1/404				(On) On	right a.	.421 (10.69), bat	1/4-40		1825192-5
TT13A2T04			1 Amp	On Off	wire lug	.200 (5.1), bat	#10-48		1825222-2
TT13A3T04			Silver plated			.286 (7.26), bat			1825223-3
TT13A6T004						.306 (7.77), rnd, col.			1825225-1
TT13A9T1/404						.421 (10.69), bat	1/4-40		1825192-6
TT13D2T04				On On		.200 (5.1), bat	#10-48		1825222-3
TT13D3T04						.286 (7.26), bat			1825223-4
TT13D7T1/404						.457 (11.61), flat	1/4-40		1825226-3
TT13D9T1/404						.421 (10.69), bat			1825192-7
TT13E2T04				On Off On		.200 (5.1), bat	#10-48		1825222-4
TT13E3T04						.286 (7.26), bat			1825223-5
TT21KGPC104		2	0.4VA	On Off	pc	.125 (3.18), bat	unthreaded		1-1825219-0
TT21NGPC104			Gold plated	On On					1-1825219-1
TT21NGPC9T1/404						.421 (10.69), bat	1/4-40		1825192-8
TT21NGRA104					right a.	.125 (3.18), bat	unthreaded		1-1825219-2
TT21NGRA7T1/404						.457 (11.61), flat	1/4-40		1825226-4
TT21NGRA9T1/404						.421 (10.69), bat			1825192-9
TT21NGWW2T04					wire wrap	.200 (5.1), bat	#10-48		1825222-5
TT23K2T04			1 Amp	On Off	wire lug				1825222-6
TT23K9T1/404			Silver plated			.421 (10.69), bat	1/4-40		1-1825192-0
TT23N2T04				On On		.200 (5.1), bat	#10-48		1825222-7
TT23N3T04						.286 (7.26), bat			1825223-6
TT23P3T04				On Off On					1825223-7
TT23P6T004						.306 (7.77), rnd, col.			1825225-2
TT23P8T1/404						.567 (14.40), locking	1/4-40		1825227-1
TT41NGPC104		4	0.4VA	On On	pc	.125 (3.18), bat	unthreaded		1-1825219-3
TT41NGPC9T1/404			Gold plated			.421 (10.69), bat	1/4-40		1-1825192-1
TT41NGRA104					right a.	.125 (3.18), bat	unthreaded		1-1825219-4
TT41NGRA7T1/404						.457 (11.61), flat	1/4-40		1825226-5
TT41NGRA9T1/404						.421 (10.69), bat			1-1825192-2
TT41NGWW2T04					wire wrap	.200 (5.1), bat	#10-48		1825222-8
TT43N2T04			1 Amp		wire lug				1825222-9
TT43N9T1/404			Silver			.421 (10.69), bat	1/4-40		1-1825192-3
TTE11EG104	yes	1	0.4VA	On Off On		.221 (5.61), bat	unthreaded		1825219-1
TTE11EGPC9T1/4ES04			0.4VA		pc	.421 (10.69), bat	1/4-40		1-1825192-4
TTE13A9T1/404			1 Amp	On Off	wire lug				1-1825192-5
TTE13D2T04			Silver plated	On On		.200 (5.1), bat	#10-48		1-1825222-0
TTE13D8T1/404						.567 (14.40), locking	1/4-40		1825227-2
TTE13E8T1/404				On Off On					1825227-3
TTE23P8T1/404		2							1825227-4
TTE11AGPC9T1/404		1	0.4VA	On Off	pc	.421 (10.69), bat			1-1825192-7

Preferred parts in bold print

Gemini A Series

Features

- Gold, gold over silver or silver contacts
- Epoxy sealed terminals
- Stainless steel frame with brass tin plated solder support
- Hardware included
- Boot seals available



Typical performance characteristics

Contact configuration 1, 2, 3, and 4 pole
 Contact timing Break before Make
 Contact rating max. gold: 0.4VA @20V AC or DC
 gold over silver : 5 A @ 125VAC or 28VDC resistive
 or 0.4VA @ 20VAC or DC or 2A @250VAC resistive
 silver: 5 A @ 125VAC or 28VDC resistive
 and 2A @ 250VAC resistive
 Electrical life 6000 cycles
 Contact resistance, initial max.10 mOhms
 Insulation resistance 1,000 MOhms
 Dielectric strength 1,000 Vrms @ sea level
 Actuator travel 22° for D and E function
 18° for F and G function

Environmental specification

Operating temperature -30°C to +85°C
 Storage temperature -30°C to +85°C
 Solder heat resistance wave solder capable to 265° C
 Terminal Seal single pole: epoxy

Material specifications

Contacts contacts B: copper alloy finish gold over nickel
 contacts G: copper alloy finish gold over silver
 contacts Q: copper alloy finish silver
 Actuator brass alloy chrome
 Terminals contacts B: copper alloy finish gold over nickel
 contacts G: copper alloy finish gold over silver
 contacts Q: copper alloy finish silver
 Case thermoplastic
 Bushing brass alloy finish nickel
 Internal actuator phenolic
 Spring music wire
 Support Bracket brass tin plated
 Seal epoxy
 RoHS Directive 2002/95/EC compliant

Toggle Switches

Product key		Typical product key									
		A	1	01	P3		Z	Q	04		
Type	Gemini A Series Toggles										
Number of Poles	1 single pole	2 double pole									
Function	single and double pole					double pole only					
	01 On-On	11 On-On-On									
	03 On-Off-On	13 On-On-(On)									
	05 (On)-Off-(On)	15 (On)-On-(On)									
	07 On-Off-(On)										
	08 On-(On)										
Toggles											
S	bat long	T	large toggle & bushing (15/32)								
K	locking	T1	large toggle & bushing (15/32)								
K1	locking	L	lever								
M	bat short	L1	lever								
P3	flatted (with bushing code Y only)	L2	lever								
Bushing											
blank	toggles K1 &/ P3: 1/4-40 threaded .35 (8.9) long toggles K, T, T1: unthreaded .28 (7.1) long										
CW	1/4-40 threaded .37 (9.4) long, enviromental seals (toggles codes S & M only)										
D	1/4-40 threaded .28 (7.1) long										
D9	unthreaded .28 (7.1) long										
H	1/4-40 threaded .3 (7.6) long										
		Y	1/4-40 threaded .35 (8.9) long								
		Y9	unthreaded .35 (8.9) long								
Terminations											
A	right angle	V30	vertical support	W	wire wrap						
AV2	vertical right angle	V40	vertical support	W4	wire wrap						
C	printed circuit			Z	wire lug						
Contacts											
B	gold	G	gold over silver	Q	silver						
Material											
04	RoHS compliant										

Gemini A Series (Continued)

Function



Code	Positions	↙	↓	↘
01	2 positions	On	None	On
03	3 positions	On	Off	On
05	3 positions	(On)	Off	(On)
07	3 positions	(On)	Off	On
08	2 positions	(On)	None	On
SPDT	Term. conn.	1 - 2	---	2 - 3
DPDT	Terminals connected	1 - 2 4 - 5	---	2 - 3 5 - 6
11*)	3 positions	On	On	On
13*)		(On)	On	On
15*)		(On)	On	(On)
DP3T	Terminals connected	1 - 2 4 - 5	2 - 3 4 - 5	2 - 3 5 - 6

Off mechanical position, no electrical connection
 (On) momentary mechanical position and electrical connection
 None no mechanical position
 *) functions available in dual pole case only.
 **) SP3T functions achieved with external jumper installed by customer

Wiring diagram for functions 11, 13, 15

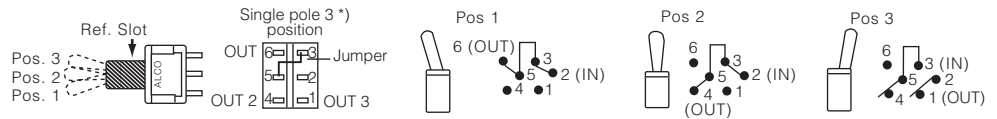

Toggles

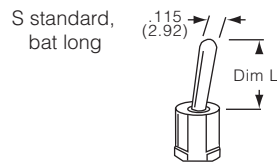

Toggle	Bushing	Dim L
S	CW, H, Y D, D9	10.41 (.410) 12.19 (.480)

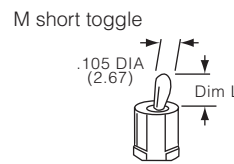

Toggle	Bushing	Dim L
M	CW, H, Y D, D9	5.08 (.200) 6.86 (.270)

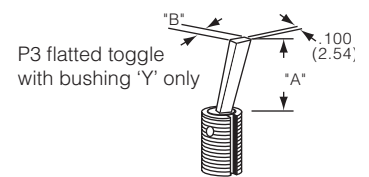

Toggle	Dim A	Dim B
P3	11.43 (.450)	5.08 (.200)

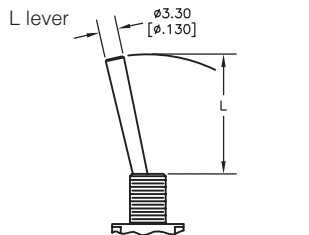

Toggle	Bushing	Dim L
L	H, Y D, D9	21.34 (.840) 23.11 (.910)

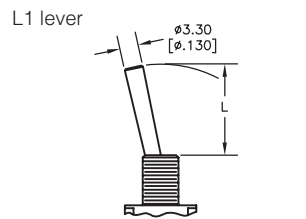

Toggle	Bushing	Dim L
L1	H, Y D, D9	16.26 (.640) 18.03 (.710)

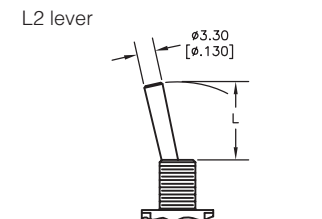

Toggle	Bushing	Dim L
L2	H, Y D, D9	13.97 (.550) 15.75 (.620)

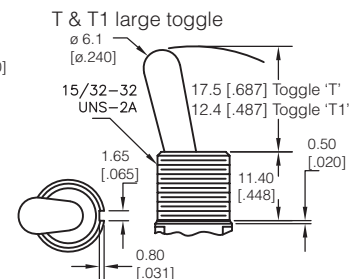
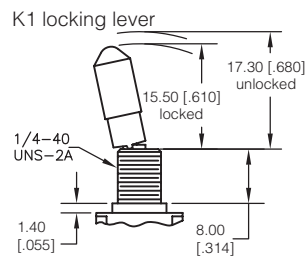
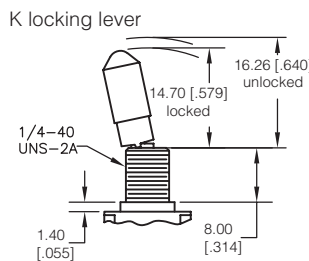

Gemini A Series (Continued)

Bushings



D 1/4-40 threaded

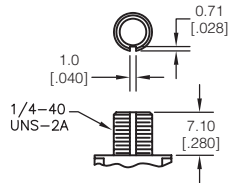

D9 unthreaded

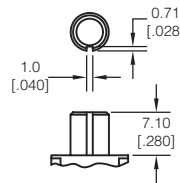

CW 1/4-40 threaded
environmental seals
(toggles codes S & M only)

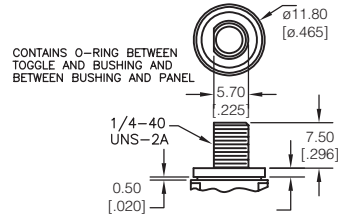

H 1/4-40 threaded

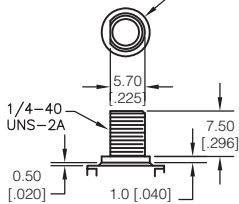

Y 1/4-40 threaded

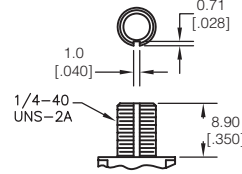

Y9 unthreaded

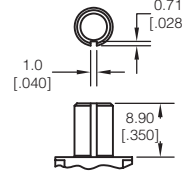

Recommended panel cut-outs

Bushing 1/4

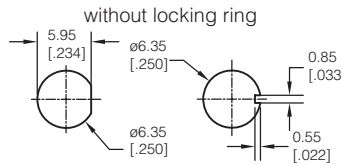

with standard locking ring

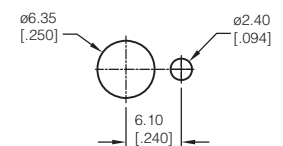

Terminals



Codes C, W, W4, Z printed circuit, wire wrap and wire lug

C printed circuit

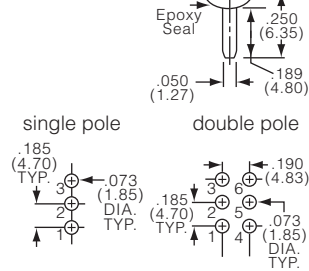

W, W4 wire wrap

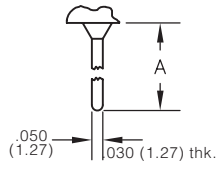

Z wire lug

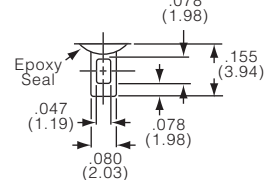

Terminal	Dim A
W	18.69 (.736)
W4	26.98 (1.062)

Code A right angle

single pole

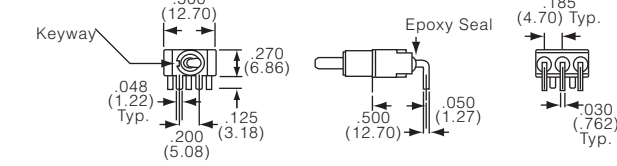

double pole

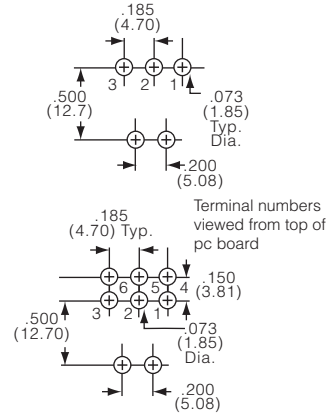
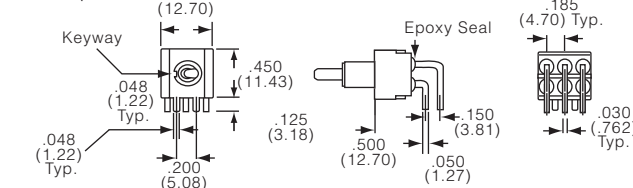

Gemini A Series (Continued)

Code AV2 vertical right angle

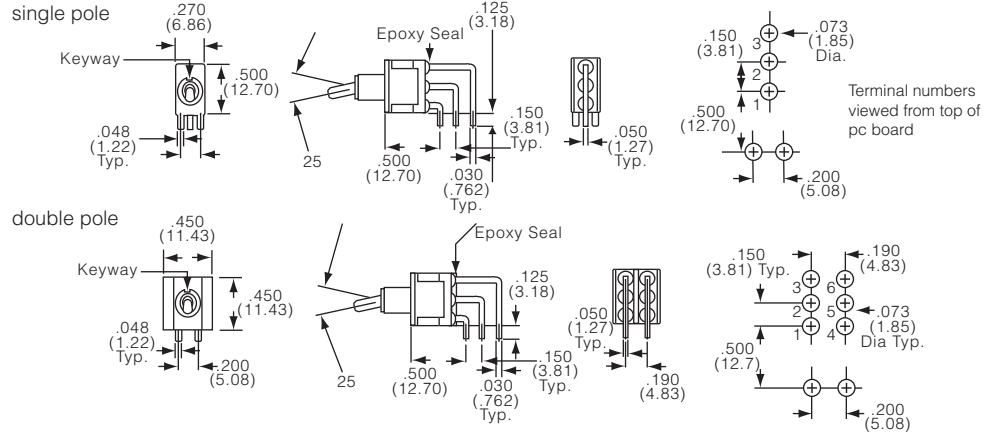

Codes V30, V40 vertical support

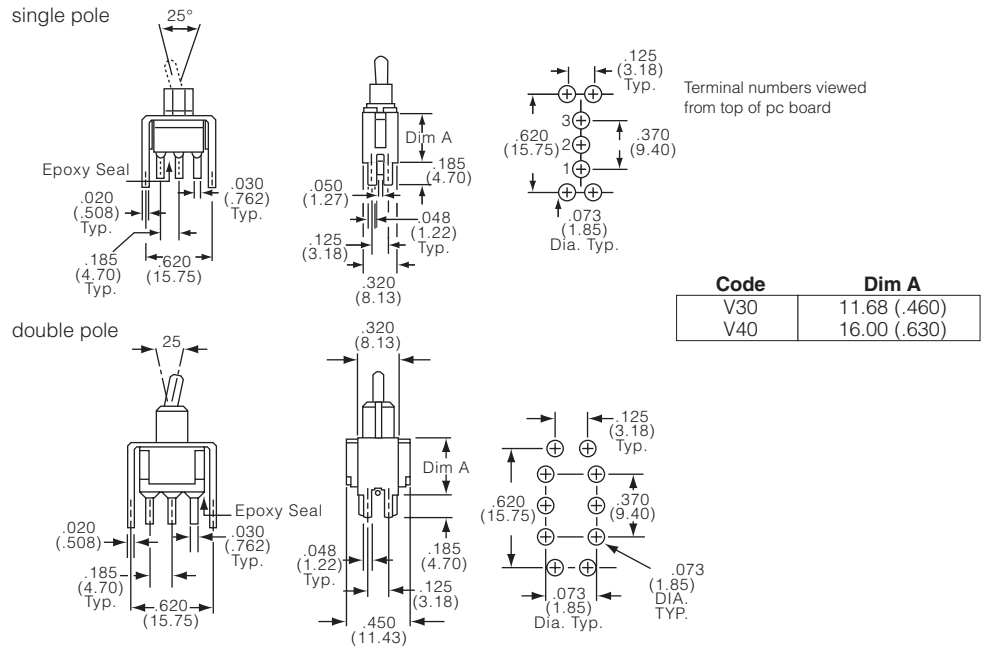

Gemini A Series (Continued)

Dimensions

Series A...KZ locking, unthreaded, wire lug, 1 & 2 pole

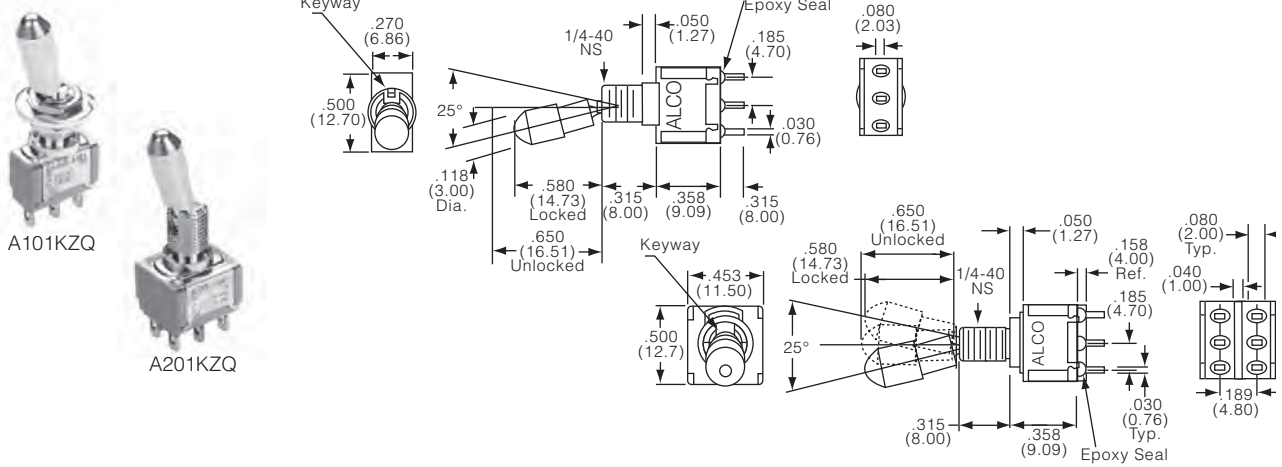

Series A...MD9A short bat, unthreaded bushing, right angle, 1 & 2 pole

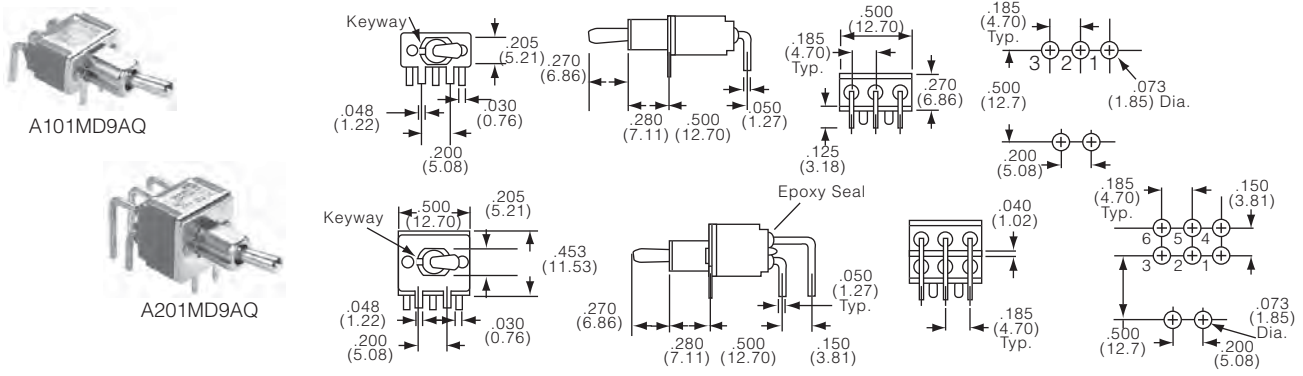

Series A...MD9AV2 short bat, unthreaded bushing, vertical right angle, 1 & 2 pole

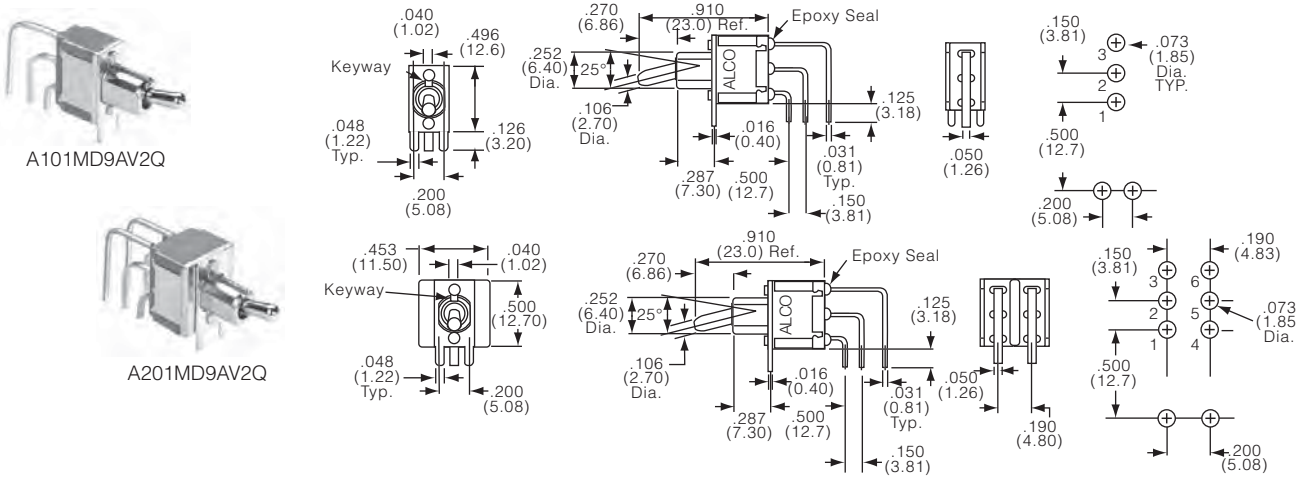

Series A...P3YZ flatted toggle, 1/4-40 threaded, wire lug, 1 & 2 pole

Toggle Switches

Gemini A Series (Continued)

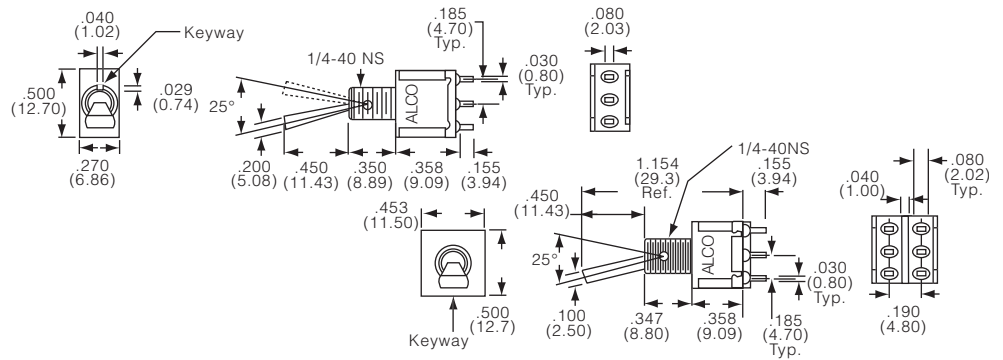

Series A...SDC long bat, 1/4-40 threaded, printed circuit, 1 & 2 pole

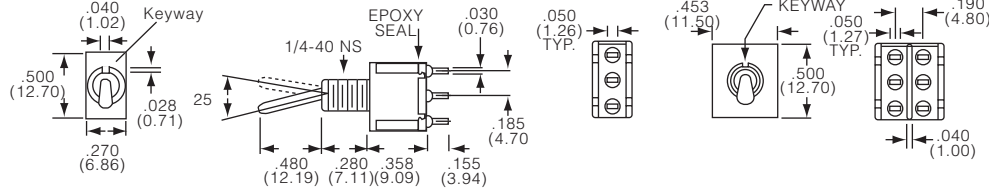

Series A...SDZ long bat, 1/4-40 threaded, wire lugs, 1 & 2 pole

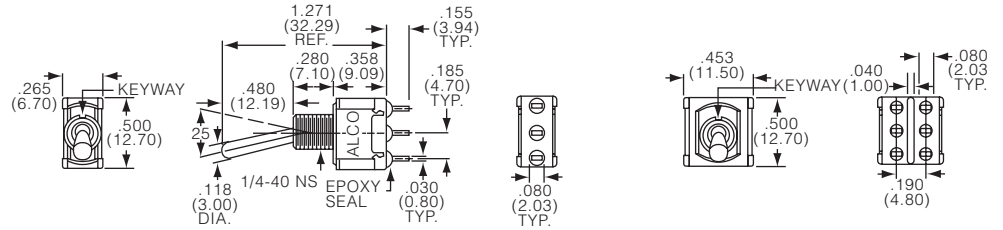

Series A...SD9A long bat, unthreaded, right angle, 1 & 2 pole

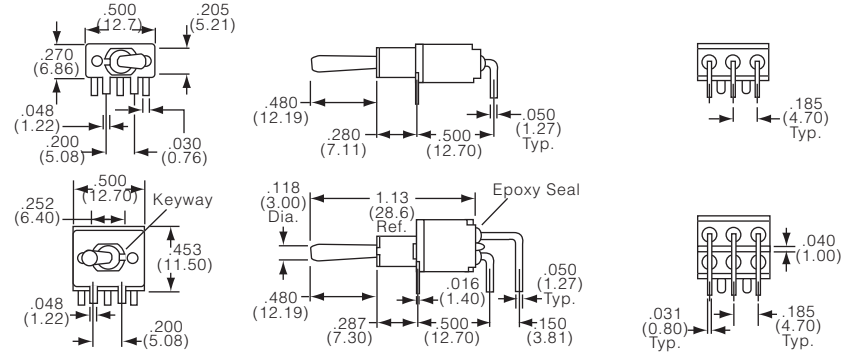

Gemini A Series (Continued)

Series A...SD9AV2 long bat, unthreaded, vertical right angle, 1 & 2 pole

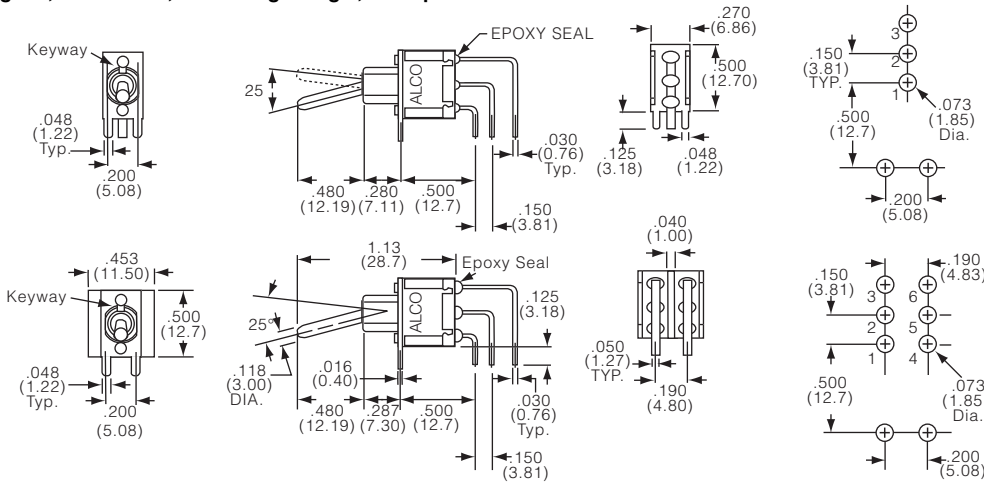
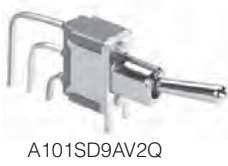

Series A...SYA long bat, 1/4-40 threaded, right angle, 1 & 2 pole

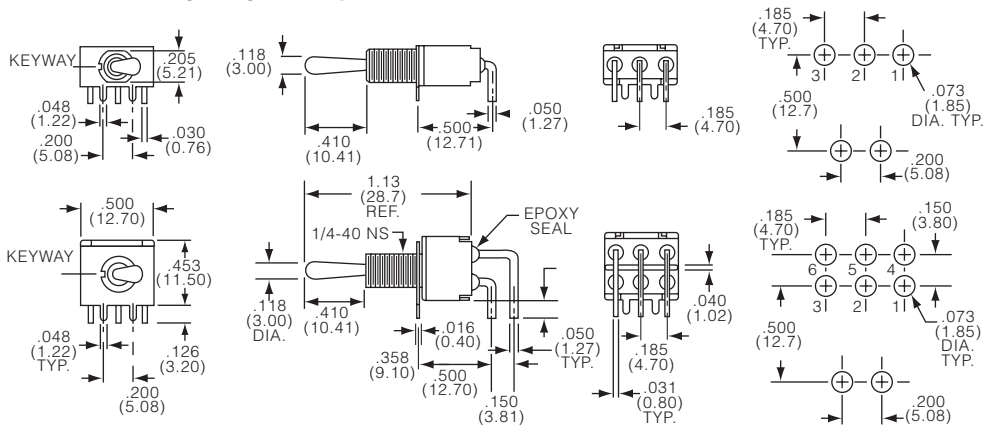

Series A...SYC long bat, 1/4-40 threaded, printed circuit, 1 & 2 pole

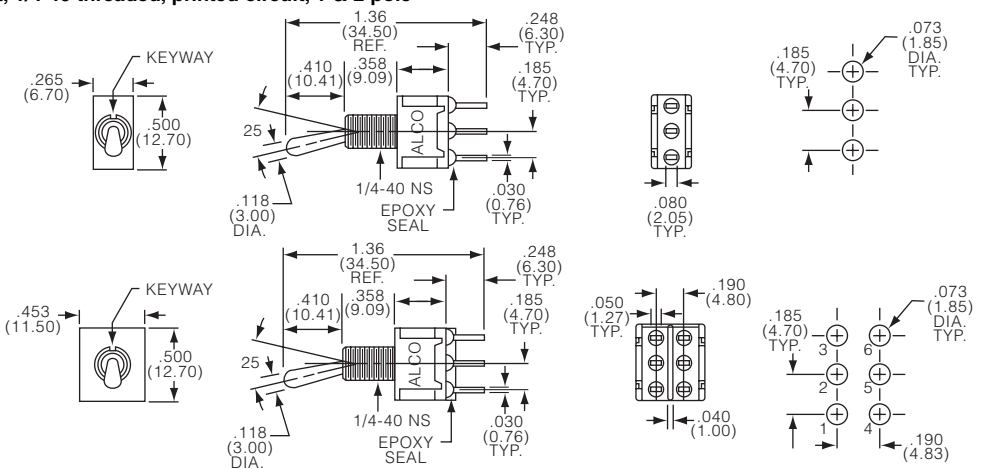
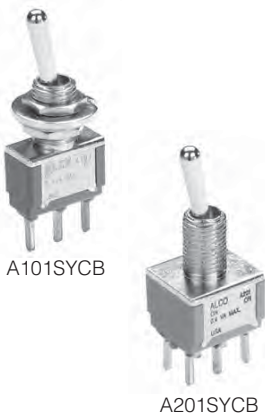

Gemini A Series (Continued)

Series A...SYW long bat, 1/4-40 threaded, wire wrap, 1 & 2 pole

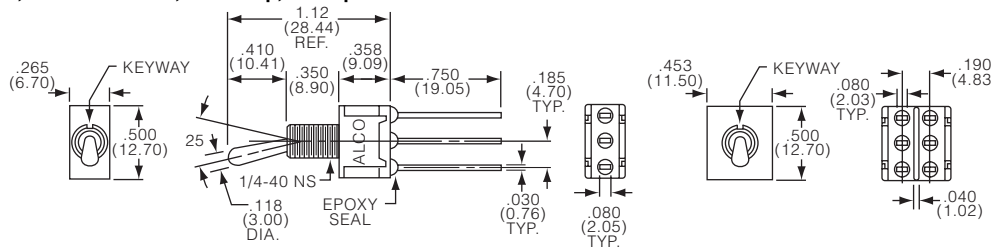

Series A...SYZ long bat, 1/4-40 threaded, wire lug, 1 & 2 pole

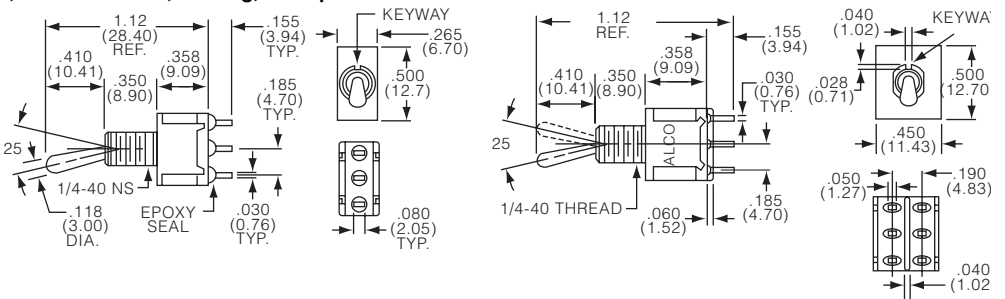

Series A...TZ large toggle, unthreaded, wire lug, 1 & 2 pole

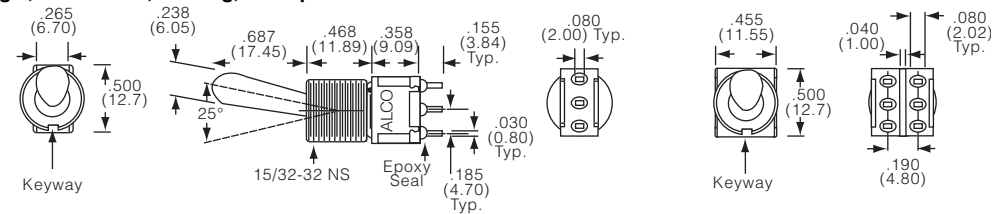

Series A...T1Z large toggle, unthreaded, wire lug, 1 & 2 pole

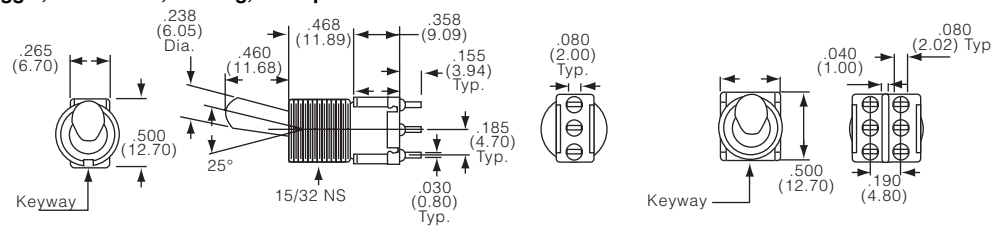

Gemini A Series (Continued)

Product key	Poles	Function	Toggles	Bushing	Terminations	Contacts	Material	Part Number
A101K1V30B04	1	On-On	locking	1/4-40 threaded .35 (8.9)	vertical support	gold	RoHS	1825136-1
A101KAB04				unthreaded .28 (7.1)	right angle	silver	compliant	1825136-2
A101KAQ04								1825136-3
A101KAV2Q04					vertical right angle			2-1825136-8
A101KCQ04					printed circuit			1825136-5
A101KD9AQ04					right angle			1825136-6
A101KZQ04					wire lug			1825136-7
A101L1D9V30Q04			lever		vertical support			1825136-9
A101L1YZB04				1/4-40 threaded .35 (8.9)	wire lug	gold		1-1825136-0
A101LDZQ04				1/4-40 threaded .28 (7.1)		silver		1-1825136-1
A101MD9AB04			bat short	unthreaded .28 (7.1)	right angle	gold		1-1825136-2
A101MD9AG04						Au over Ag		1-1825136-3
A101MD9AQ04						silver		1-1825136-4
A101MD9AV2B04					vertical right angle	gold		1-1825136-5
A101MD9AV2G04						Au over Ag		1-1825136-6
A101MD9AV2Q04						silver		1-1825136-7
A101MD9V30B04					vertical support	gold		1-1825136-8
A101MDAQ04				1/4-40 threaded .28 (7.1)	right angle	silver		1-1825136-9
A101MDAV2B04					vertical right angle	gold		2-1825136-0
A101MDCG04					printed circuit	Au over Ag		2-1825136-1
A101MDZQ04					wire lug	silver		2-1825136-2
A101MYCQ04				1/4-40 threaded .35 (8.9)	printed circuit			2-1825136-3
A101MYZQ04					wire lug			2-1825136-4
A101P3CB04			flatted		printed circuit	gold		2-1825136-6
A101P3YV30B04					vertical support			1825136-4
A101P3ZQ04					wire lug	silver		2-1825136-7
A101SCWCQ004			bat long	1/4-40 threaded .37 (9.4)	printed circuit			3-1825136-0
A101SCWZQ04					wire lug			3-1825136-1
A101SD9AB04				unthreaded .28 (7.1)	right angle	gold		3-1825136-2
A101SD9AQ04						silver		3-1825136-3
A101SD9AV2B04					vertical right angle	gold		3-1825136-4
A101SD9AV2Q04						silver		3-1825136-5
A101SD9V30B04					vertical support	gold		3-1825136-6
A101SD9V30Q04						silver		3-1825136-7
A101SDCCQ04				1/4-40 threaded .28 (7.1)	printed circuit			3-1825136-8
A101SDZQ04					wire lug			3-1825136-9
A101SHZQ04				1/4-40 threaded .3 (7.6)				4-1825136-0
A101SY9CQ04				unthreaded .35 (8.9)	printed circuit			4-1825136-1
A101SYAB04				1/4-40 threaded .35 (8.9)	right angle	gold		4-1825136-2
A101SYAQ04						silver		4-1825136-3
A101SYAV2B04					vertical right angle	gold		1825136-8
A101SYCB04					printed circuit			4-1825136-4
A101SYCQ04						silver		4-1825136-5
A101SYWQ04					wire wrap			4-1825136-7
A101SYZB04					wire lug	gold		4-1825136-8
A101SYZQ04						silver		4-1825136-9
A101T1ZB04			lg. tgl. & bushing	unthreaded .28 (7.1)		gold		5-1825136-2
A101T1ZQ04						silver		5-1825136-3
A101TCQ04					printed circuit			5-1825136-4
A101TZQ04					wire lug			5-1825136-5
A103KZQ04		On-Off-On	locking					1825137-1
A103MD9AB04			bat short		right angle	gold		1825137-2
A103MD9AG04						Au over Ag		1825137-3
A103MD9AQ04						silver		1825137-4
A103MD9AV2B04					vertical right angle	gold		1825137-5
A103P3ZQ04			flatted	1/4-40 threaded .35 (8.9)	wire lug	silver		1825137-6
A103SD9AQ04			bat long	unthreaded .28 (7.1)	right angle			1825137-7
A103SD9AV2B04					vertical right angle	gold		1825137-8
A103SD9AV2Q04						silver		1825137-9
A103SDCB04				1/4-40 threaded .28 (7.1)	printed circuit	gold		1-1825137-0
A103SDCCQ04						silver		1-1825137-1
A103SDZQ04					wire lug			1-1825137-2
A103SYAQ04				1/4-40 threaded .35 (8.9)	right angle			1-1825137-3
A103SYAV2B04					vertical right angle	gold		2-1825136-5
A103SYAV2Q04						silver		1-1825137-4
A103SYCB04					printed circuit	gold		1-1825137-5
A103SYCQ04						silver		1-1825137-6
A103SYWB04					wire wrap	gold		1-1825137-7
A103SYWQ04					right angle	silver		1-1825137-8
A103SYZB04					wire lug	gold		1-1825137-9
A103SYZQ04						silver		2-1825137-0
A103T1CG04			lg. tgl. & bushing	unthreaded .28 (7.1)	printed circuit	Au over Ag		2-1825137-1
A103T1ZQ04					wire lug	silver		2-1825137-2
A103TZQ04								2-1825137-3

Preferred parts in bold print

Toggle Switches

Gemini A Series (Continued)

Toggle Switches

Product key	Poles	Function	Toggles	Bushing	Terminations	Contacts	Material	Part Number								
A105MD9AB04	1	(On)-Off-(On)	bat short	unthreaded .28 (7.1)	right angle	gold	RoHS compliant	2-1825137-4								
A105MD9AQ04						silver		2-1825137-5								
A105MYV30Q04				1/4-40 threaded .35 (8.9)	vertical support	Au over Ag		2-1825137-6								
A105P3CG04								printed circuit	2-1825137-7							
A105P3CQ04								silver	2-1825137-8							
A105P3ZQ04								wire lug	2-1825137-9							
A105SD9AB04								bat long	unthreaded .28 (7.1)	right angle	gold	3-1825137-1				
A105SD9AV2Q04										vertical right angle	silver	3-1825137-2				
A105SD9V30B04								1/4-40 threaded .35 (8.9)			vertical support	gold	3-1825137-3			
A105SYAB04											right angle		3-1825137-4			
A105SYAV2B04											vertical right angle		3-1825137-5			
A105SYCB04											printed circuit		3-1825137-6			
A105SYCQ04					silver		3-1825137-7									
A105SYZB04					gold		3-1825137-8									
A105SYZQ04					silver		3-1825137-9									
A105T1ZB04			lg. tgl.& bushing	unthreaded .28 (7.1)				gold								
A105T1ZQ04								silver	4-1825137-0							
A105TZQ04									4-1825137-1							
A107KAV2Q04								On-Off-(On)	locking			vertical right angle			4-1825137-2	
A107KZB04															wire lug	4-1825137-3
A107MD9AV2B04										bat short		vertical right angle	gold		4-1825137-4	
A107MD9CQ04															vertical right angle	4-1825137-5
A107MD9V30Q04															printed circuit	4-1825137-6
A107P3ZQ04															vertical support	4-1825137-7
A107SYAQ04															flatted	1/4-40 threaded .35 (8.9)
A107SYCB04	bat long		right angle	4-1825137-9												
A107SYCQ04					printed circuit	gold	5-1825137-0									
A107SYZQ04					silver	5-1825137-1										
A107TZB04					wire lug	5-1825137-2										
A108MD9AB04		On-(On)	bat short	unthreaded .28 (7.1)	right angle										5-1825137-3	
A108P3CQ04								printed circuit	5-1825137-6							
A108P3ZQ04								flatted	1/4-40 threaded .35 (8.9)	wire lug	5-1825136-8					
A108SD9AQ04									5-1825136-9							
A108SD9V30Q04								bat long	unthreaded .28 (7.1)	right angle	6-1825136-0					
A108SYCB04									1/4-40 threaded .28 (7.1)	wire lug	6-1825136-1					
A108SYCQ04									1/4-40 threaded .35 (8.9)	printed circuit	6-1825136-2					
A108SYZQ04										gold	6-1825136-3					
A201KAB04								2	On-On	locking	unthreaded .28 (7.1)	right angle	gold		6-1825136-4	
A201KD9AQ04													silver	1825138-1		
A201KZQ04	wire lug	1825138-2														
A201L1D9V30Q04			lever		vertical support			1825138-3								
A201MD9AB04								bat short	right angle	gold	1825138-5					
A201MD9AQ04									vertical right angle	silver	1825138-6					
A201MD9AV2B04									vertical right angle	gold	1825138-7					
A201MD9AV2Q04										silver	1825138-8					
A201MDA04											1825138-9					
A201MYAQ04											1-1825138-0					
A201MYCB04											1-1825138-2					
A201MYZQ04											1-1825138-3					
A201P3ZQ04											1-1825138-4					
A201SCWZB04			flatted	1/4-40 threaded .37 (9.4)				1-1825138-5								
A201SD9AQ04								bat long	1/4-40 threaded .37 (9.4)	right angle	gold	1-1825138-6				
A201SD9AV2Q04									unthreaded .28 (7.1)	vertical right angle	silver	1-1825138-7				
A201SDCB04										right angle	gold	1-1825138-8				
A201SDZQ04										printed circuit	silver	1-1825138-9				
A201SY9AB04										wire lug	gold	2-1825138-0				
A201SYAB04										unthreaded .35 (8.9)	right angle	2-1825138-1				
A201SYAQ04										1/4-40 threaded .35 (8.9)		2-1825138-2				
A201SYCB04											printed circuit	gold	2-1825138-3			
A201SYCQ04											silver	2-1825138-4				
A201SYWQ04					wire wrap		2-1825138-5									
A201SYZB04					gold	2-1825138-6										
A201SYZQ04					silver	2-1825138-7										
A201T1ZQ04			lg. tgl.& bushing	unthreaded .28 (7.1)				2-1825138-8								
A201TZQ04									2-1825138-9							
								3-1825138-1								

Preferred parts in bold print

Gemini A Series (Continued)

Product key	Poles	Function	Toggles	Bushing	Terminations	Contacts	Material	Part Number
A203KZQ04	2	On-Off-On	locking	unthreaded .28 (7.1)	wire lug	silver	RoHS	1825139-1
A203MD9AB04			bat short		right angle	gold	compliant	1825139-2
A203P3AV2Q04			flatted	1/4-40 threaded .35 (8.9)	vertical right angle	silver		1825139-3
A203P3ZQ04					wire lug		1825139-4	
A203SD9AV2B04			bat long	unthreaded .28 (7.1)	vertical right angle	gold		1825139-5
A203SD9AV2Q04						silver	1825139-6	
A203SDZQ04				1/4-40 threaded .28 (7.1)	wire lug			1825139-7
A203SYCB04					1/4-40 threaded .35 (8.9)	printed circuit	gold	
A203SYCQ04						silver		1825139-9
A203SYZQ04					wire lug			1-1825139-0
A203T1ZQ04			lg. tgl.& bushing	unthreaded .28 (7.1)				1-1825139-1
A203TZQ04								1-1825139-2
A205KZB04		(On)-Off-(On)	locking	1/4-40 threaded .35 (8.9)		gold		1-1825139-3
A205P3ZQ04			flatted			silver	1-1825139-4	
A205SD9AB04			bat long	unthreaded .28 (7.1)	right angle	gold		1-1825139-5
A205SYCB04					1/4-40 threaded .35 (8.9)	printed circuit		1-1825139-6
A205SYCQ04						silver		1-1825139-7
A205SYZQ04						wire lug		1-1825139-8
A205T1ZQ04			lg. tgl.& bushing	unthreaded .28 (7.1)				1-1825139-9
A205TZQ04								2-1825139-0
A207P3ZQ04		On-Off-(On)	flatted	1/4-40 threaded .35 (8.9)				2-1825139-1
A207SYCB04			bat long			printed circuit	gold	
A207SYCQ04						silver		2-1825139-3
A207SYZQ04						wire lug		2-1825139-4
A207T1ZQ04			lg. tgl.& bushing	unthreaded .28 (7.1)				2-1825139-5
A207TZQ04								2-1825139-6
A208KZG04		On-(On)	locking	1/4-40 threaded .35 (8.9)		Au over Ag		3-1825138-2
A208P3ZQ04			flatted			silver	3-1825138-3	
A208SD9AQ04			bat long	unthreaded .28 (7.1)	right angle			3-1825138-4
A208SD9AV2Q04					1/4-40 threaded .35 (8.9)	vertical right angle		3-1825138-5
A208SYCB04					printed circuit	gold		3-1825138-6
A208SYCQ04						wire lug		silver
A208SYZQ04								3-1825138-8
A208T1ZQ04					lg. tgl.& bushing	unthreaded .28 (7.1)		
A208TZQ04								4-1825138-0
A211KZB04					locking			gold
A211MD9AQ04			bat short	1/4-40 threaded .35 (8.9)	right angle	silver		2-1825139-8
A211MYCQ04							printed circuit	
A211P3CQ04			flatted					3-1825139-0
A211P3V40G04							vertical support	Au over Ag
A211P3ZQ04					wire lug	silver		3-1825139-2
A211SCWCQ04					bat long	1/4-40 threaded .37 (9.4)	printed circuit	
A211SDZQ04				1/4-40 threaded .28 (7.1)	wire lug			3-1825139-4
A211SHZQ04					1/4-40 threaded .3 (7.6)			3-1825139-5
A211SY9AQ04				unthreaded .35 (8.9)	right angle			3-1825139-6
A211SYCQ04					1/4-40 threaded .35 (8.9)	printed circuit		
A211SYZB04					wire lug	gold		3-1825139-8
A211SYZQ04								silver
A211T1ZQ04			lg. tgl.& bushing	unthreaded .28 (7.1)				4-1825139-0
A213SYZQ04					bat long	1/4-40 threaded .35 (8.9)		
A215SD9V30B04		(On)-On-(On)		unthreaded .28 (7.1)	vertical support	gold		4-1825139-3
A215SY9AQ04			(On)-On-(On)		unthreaded .35 (8.9)	right angle	silver	4-1825139-4
A215SYZQ04				1/4-40 threaded .35 (8.9)	wire lug			4-1825139-5

Preferred parts in bold print

Gemini AE Series, Sealed IP67

Features

- Meets IP 67 requirements
- Gold, gold over silver or silver contacts
- Stainless steel frame with brass tin plated solder support
- Epoxy sealed terminals



Typical performance characteristics

Contact configuration 1, 2, 3, and 4 pole
 Contact timing Break before Make
 Contact rating max. gold: 0.4VA @20V AC or DC
 gold over silver : 5 A @ 125VAC or 28VDC resistive
 or 0.4VA @ 20VAC or DC or 2A @250VAC resistive
 silver: 5 A @ 125VAC or 28VDC resistive
 and 2A @ 250VAC resistive
 Electrical life 6000 cycles
 Contact resistance, initial max.10 mOhms @ 2 to 4VDC, 100mA
 Insulation resistance min. 1,000 MOhms
 Dielectric strength 1,000 Vrms @ sea level
 Actuator travel 22° for D and E function
 18° for F and G function

Material specifications

Contacts contacts B: copper alloy finish gold over nickel
 contacts G: copper alloy finish gold over silver
 contacts Q: copper alloy finish silver
 Actuator brass alloy chrome
 Terminals contacts B: copper alloy finish gold over nickel
 contacts G: copper alloy finish gold over silver
 contacts Q: copper alloy finish silver
 Case thermoplastic
 Bushing brass alloy finish nickel
 Internal actuator phenolic
 Spring music wire
 Support bracket brass tin plated
 Seal epoxy
 RoHS Directive 2002/95/EC compliant

Environmental specification

Operating temperature -30°C to +85°C
 Storage temperature -30°C to +85°C
 Solder heat resistance wave solder capable to 265° C
 Terminal seal epoxy

Toggle Switches

Product key	Typical product key									
	AE	1	01	S	D1	C	Q	04		
Type	AE Gemini AE Series Toggles									
Number of Poles	1	single pole		2	double pole					
Function	single and double pole			double pole only						
	01	On-On		11	On-On-On					
	03	On-Off-On		13	On-On-(On)					
	05	(On)-Off-(On)		15	(On)-On-(On)					
	07	On-Off-(On)								
	08	On-(On)								
Toggles	S	bat long			M	bat short				
Bushing	D1	unthreaded								
Terminations	A	right angle	V30	vertical support	W	wire wrap				
	AV2	vertical right angle	V40	vertical support	W4	wire wrap				
	C	printed circuit	Z	wire lug						
Contacts	B	gold		G	gold over silver		Q	silver		
Material	04	RoHS compliant								

Gemini AE Series, Sealed IP67 (Continued)

Function



Code	Positions	↘	↓	↙
01	2 positions	On	None	On
03	3 positions	On	Off	On
05	3 positions	(On)	Off	(On)
07	3 positions	(On)	Off	On
08	2 positions	(On)	None	On
SPDT	Term. conn.	1 - 2	---	2 - 3
DPDT	Terminals connected	1 - 2 4 - 5	---	2 - 3 5 - 6
11*)	3 positions	On	On	On
13*)		(On)	On	On
15*)		(On)	On	(On)
DP3T	Terminals connected	1 - 2 4 - 5	2 - 3 4 - 5	2 - 3 5 - 6

Off mechanical position, no electrical connection
 (On) momentary mechanical position and electrical connection
 None no mechanical position
 *) functions available in dual pole case only.
 **) SP3T functions achieved with external jumper installed by customer

Wiring diagram for functions 11, 13, 15

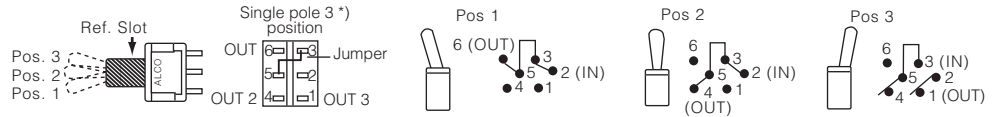

Toggles



S standard, bat long

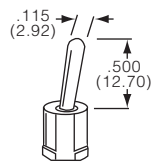

M short toggle

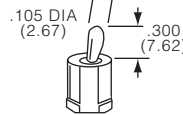

Terminals



Codes C, W, W4, Z printed circuit, wire wrap and wire lug

C printed circuit

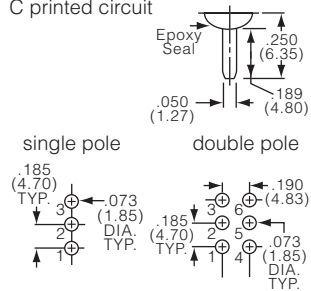

W, W4 wire wrap

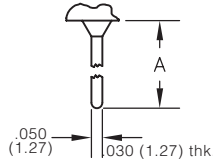

Z wire lug

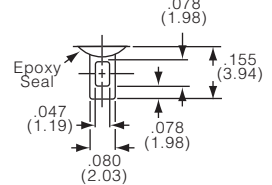

Terminal	Dim A
W	18.69 (.736)
W4	26.98 (1.062)

Code A right angle

single pole

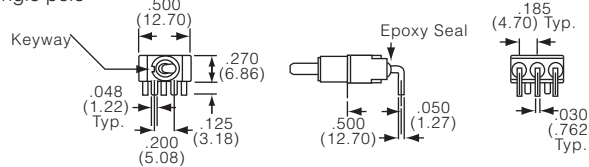

double pole

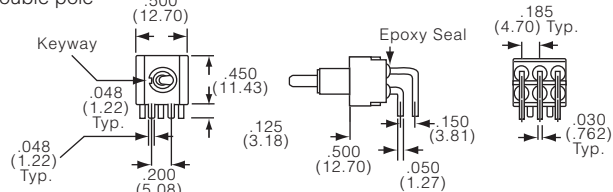

Gemini AE Series, Sealed IP67 (Continued)

Code AV2 vertical right angle

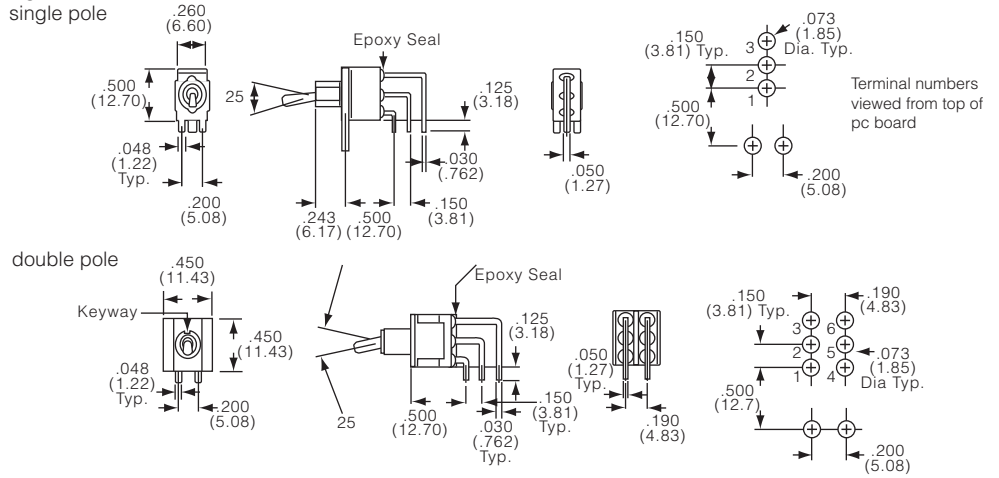

Codes V30, V40 vertical support

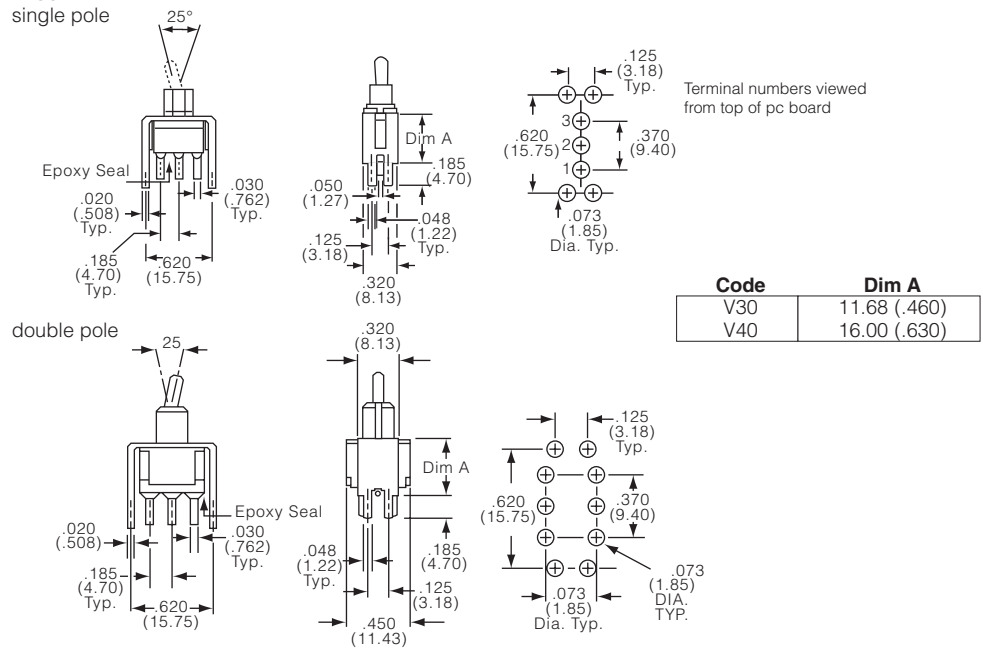

Gemini AE Series, Sealed IP67 (Continued)

Dimensions

Series AE...MD1A short bat, unthreaded, right angle, 1 & 2 pole



AE101MD1AQ

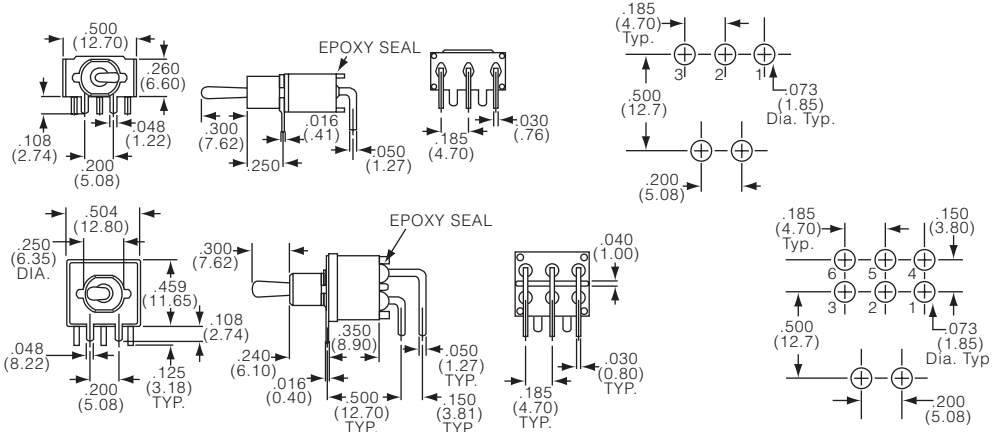

Series AE...MD1AV2 short bat, unthreaded, vertical right angle, 1 & 2 pole



AE101MD1AV2Q



AE201MD1AV2Q

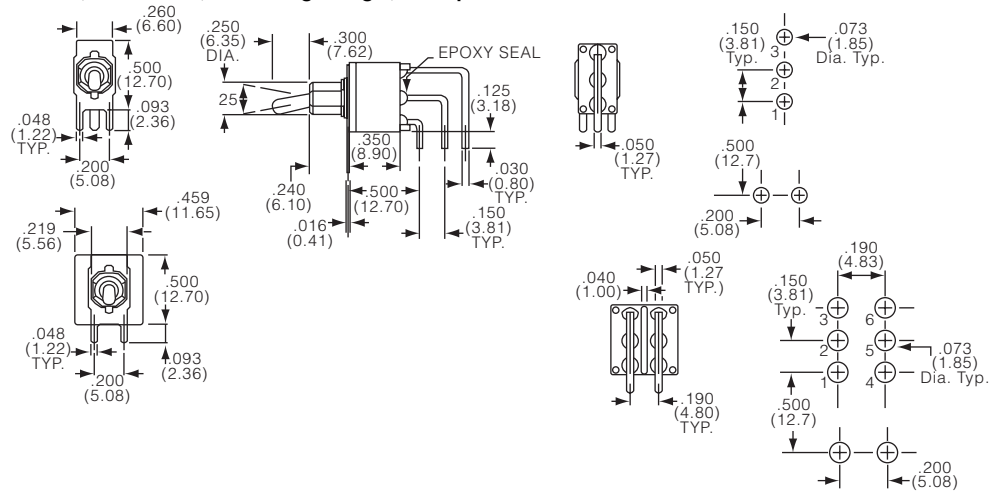

Series AE...MD1C short bat, unthreaded, printed circuit, 1 & 2 pole



AE101MD1CQ



AE201MD1CQ

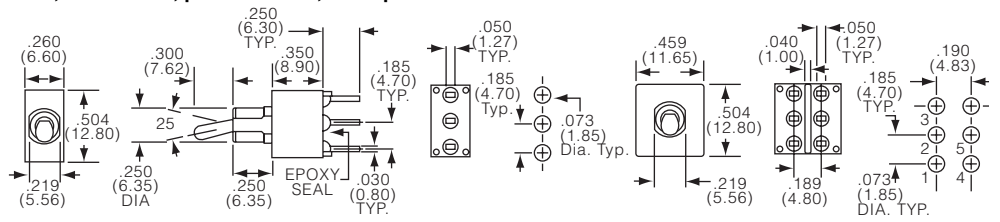

Toggle Switches

Gemini AE Series, Sealed IP67 (Continued)

Series AE...SD1A long bat, unthreaded, right angle, 1 & 2 pole

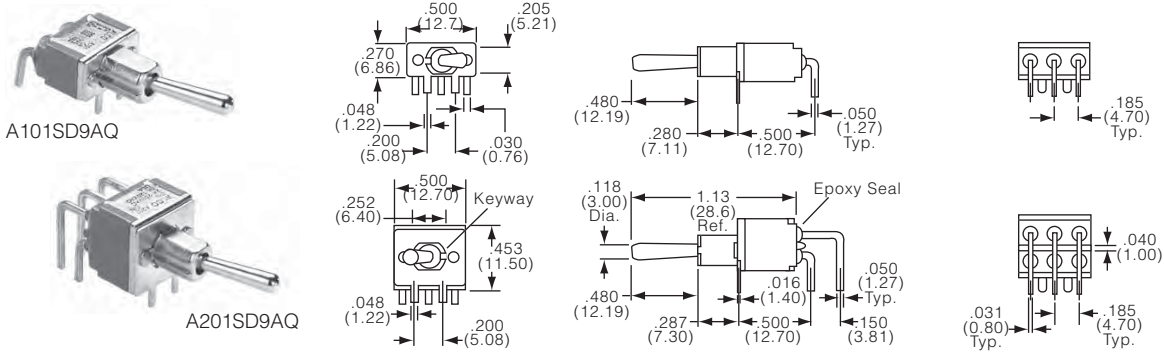

Series AE...SD1AV2 long bat, unthreaded, vertical right angle, 1 & 2 pole

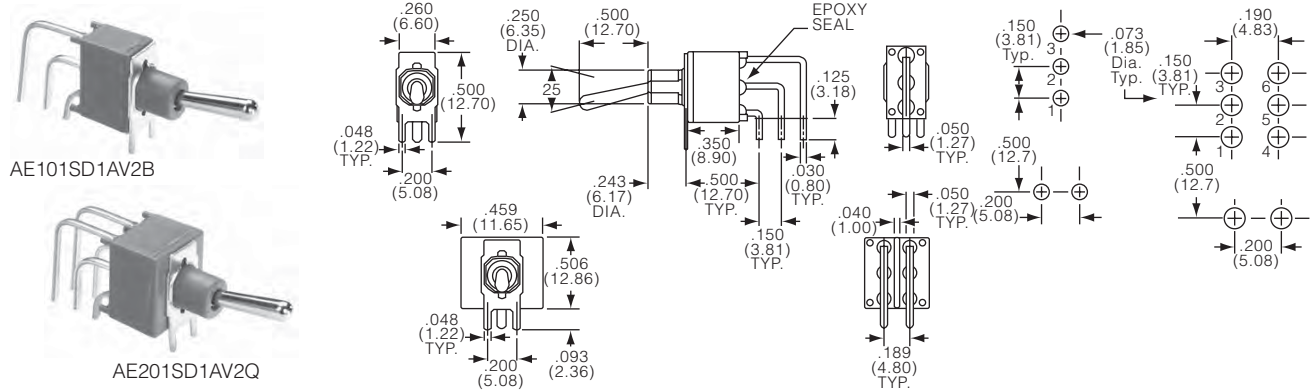

Series AE...SD1C long bat, unthreaded, printed circuit, 1 & 2 pole

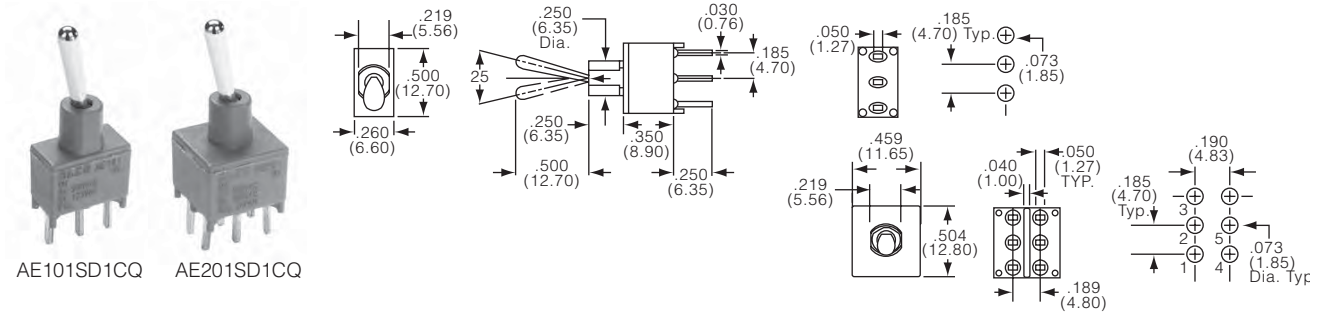

Toggle Switches

Gemini AE Series, Sealed IP67 (Continued)

Product key	Poles	Function	Toggles	Bushing	Terminations	Contacts	Material	Part Number					
AE101MD1AB04	1	On-On	bat short	unthreaded	right angle	gold	RoHS	1825142-1					
AE101MD1AG04						Au over Ag		1825142-2					
AE101MD1AQ04						silver		1825142-4					
AE101MD1AV2B04						vertical right angle		gold	1825142-5				
AE101MD1AV2Q04								silver	1825142-6				
AE101MD1CB04						printed circuit		gold	1825142-8				
AE101MD1CG04								Au over Ag	1825142-9				
AE101MD1CQ04						silver		1-1825142-0					
AE101MD1V30B04						vertical support		gold	1-1825142-1				
AE101MD1V30Q04								silver	1-1825142-2				
AE101MD1W4B04						wire wrap		gold	1-1825142-3				
AE101MD1W4Q04								silver	1-1825142-4				
AE101SD1AB04									bat long		right angle	gold	1-1825142-5
AE101SD1AQ04												silver	1-1825142-6
AE101SD1AV2B04									vertical right angle		gold	1-1825142-8	
AE101SD1AV2Q04											silver	1-1825142-9	
AE101SD1CB04									printed circuit		gold	2-1825142-0	
AE101SD1CQ04											silver	2-1825142-1	
AE101SD1V30B04									vertical support		gold	2-1825142-2	
AE101SD1V30Q04											silver	2-1825142-3	
AE103MD1AB04	On-Off-On	bat short			right angle		gold		2-1825142-4				
AE103MD1AV2B04							vertical right angle		2-1825142-5				
AE103MD1CB04					printed circuit				2-1825142-6				
AE103MD1W4B04							wire wrap		2-1825142-8				
AE103SD1AV2B04					vertical right angle	bat long	2-1825142-9						
AE103SD1CB04							printed circuit	3-1825142-0					
AE103SD1CQ04					silver	3-1825142-1							
AE103SD1V30B04					vertical support		3-1825142-3						
AE103SD1W4B04						wire wrap	3-1825142-4						
AE105MD1AB04					(On)-Off-(On)	bat short			right angle		3-1825142-5		
AE105MD1AG04										Au over Ag	3-1825142-6		
AE105MD1AV2B04									vertical right angle		3-1825142-7		
AE105MD1W4B04	wire wrap	3-1825142-8											
AE105SD1CB04	printed circuit	bat long	3-1825142-9										
AE105SD1V30B04			vertical support	4-1825142-0									
AE105SD1W4B04	wire wrap	4-1825142-1											
AE107MD1AV2B04	On-Off-(On)	bat short							vertical right angle		4-1825142-2		
AE107SD1AB04										right angle	4-1825142-3		
AE107SD1AG04	printed circuit	bat long		4-1825142-4									
AE107SD1CB04			Au over Ag	4-1825142-5									
AE107SD1V30B04	vertical support		4-1825142-6										
AE108MD1AQ04		right angle	4-1825142-7										
AE108MD1AV2B04	vertical right angle		4-1825142-8										
AE108MD1AV2Q04		silver	4-1825142-9										
AE108SD1AB04	right angle	bat long	5-1825142-0										
AE108SD1AQ04			silver	5-1825142-1									
AE108SD1CQ04	printed circuit	5-1825142-2											
AE108SD1V30B04	vertical support	5-1825142-4											
AE108SD1W4B04	wire wrap	5-1825142-5											
AE201MD1AB04	2	On-On	bat short		right angle		1825143-1						
AE201MD1AQ04						silver	1825143-2						
AE201MD1AV2B04						vertical right angle	gold	1825143-3					
AE201MD1CB04							printed circuit	1825143-4					
AE201MD1CQ04						silver	1825143-5						
AE201MD1W4B04						wire wrap	gold	1825143-6					
AE201SD1AB04							right angle	1825143-7					
AE201SD1AG04						vertical right angle	Au over Ag	1825143-8					
AE201SD1AV2B04							gold	1825143-9					
AE201SD1CB04						printed circuit		1-1825143-0					
AE201SD1CQ04							silver	1-1825143-1					
AE201SD1W4B04						wire wrap	1-1825143-2						
AE203MD1AB04						On-Off-On	bat short			right angle		1-1825143-3	
AE203MD1AQ04											silver	1-1825143-4	
AE203MD1AV2B04										vertical right angle	gold	1-1825143-5	
AE203SD1AB04											right angle	1-1825143-6	
AE203SD1AV2B04										vertical right angle		1-1825143-7	
AE203SD1AV2Q04											silver	1-1825143-8	
AE203SD1CB04										printed circuit	gold	1-1825143-9	
AE203SD1W4B04											wire wrap	2-1825143-0	
AE205MD1AV2B04	(On)-Off-(On)	bat short			vertical right angle						2-1825143-1		
AE205SD1CQ04										printed circuit	2-1825143-2		
AE207MD1AB04	On-Off-(On)	bat short			right angle					gold	2-1825143-4		
AE208SD1W4B04										On-(On)	bat long	2-1825143-5	
AE211MD1CB04	On-On-On	bat short			printed circuit		2-1825143-6						
AE211MD1V30B04						vertical support	2-1825143-7						

Preferred parts in bold print

MT Green Series

Features

- Wire lug, PC terminals, both right angle and vertical right angle
- MTE series splashproof toggle actuator
- Entire series epoxy sealed terminals
- Actuator guards, decorative hardware, and silicone boot seals available



Typical performance characteristics

Contact configuration SPDT, DPDT, 3PDT, 4PDT
 Contact timing Break-before-make
 Contact rating max. 6A @ 125VAC, 3A @ 250VAC
 Contact resistance, initial max.10 mOhms
 Insulation resistance min. 1,000 MOhms
 Dielectric strength 1,500 Vrms @ sea level
 Actuation force 4 to 20 N (0.4 to 2 kgf)
 Actuator travel 24°~26°

Material specifications

Contacts copper alloy silver clad
 Toggle brass nickel plated
 Terminals copper alloy gold flash
 Terminal seal epoxy
 Housing alkyd polyester (green)UL94 V-O
 Frame stainless steel
 Support Bracket steel nickel plated
 Spring music wire
 RoHS Directive 2002/95/EC compliant

Environmental specification

Operating temperature -20°C to +80°C
 Storage temperature -40°C to +80°C
 Solder heat resistance wave solder capable to 265° C
 Seal epoxy sealed terminals
 MTE series splashproof toggle actuator O-ring

Toggle Switches

Product key		Typical product key		MT	A	1	06	E	PC	04
Type		Green series toggle switches, panel mount								
Toggle & bushing										
A	.410 long round toggle, 1/4-40 bushing									
A8	.410 long round toggle, 1/4-40 bushing, right angle & vertical right angle									
B	.600 long round toggle with plastic tip, 1/4-40 bushing									
E	.410 long round toggle, 1/4-40 bushing with O ring seal									
F	.485 long flat toggle, 1/4-40 bushing									
G	.452 long large diameter round toggle, 15/32 bushing									
G2	.685 long large diameter round toggle, 15/32 bushing									
L	locking toggle, 1/4-40 bushing									
M	.270 long round toggle, 1/4-40 bushing									
M8	.270 long round toggle, 1/4-40 bushing, right angle & vertical right angle									
Number of Poles										
1	single pole	3	3 pole							
2	double pole	4	4 pole							
Toggle style										
06	standard	26	bright nickel, for toggle F	6	standard for toggle G2					
Function										
1 and 3 pole		2 and 4 pole		1 and 2 pole functionality *)						
D	ON-ON	N	ON-ON	PA	ON-ON-ON					
E	ON-OFF-ON	P	ON-OFF-ON	SA	(ON)-ON-(ON)					
F	ON-(ON)	R	ON-(ON)	TA	ON-ON-(ON)					
G	(ON)-OFF-(ON)	S	(ON)-OFF-(ON)	*) 2 and 4 pole design, internally connected						
H	ON-OFF-(ON)	T	ON-OFF-(ON)	for 1 and 2 pole functionality						
Terminations										
blank	wire lug	RA	right angle							
PC	printed circuit board	VRA	vertical right angle							
Material										
04	RoHS compliant									

MT Green Series (Continued)

MTA



MTA1, MTA2 1 & 2 pole



MTA106D04 MTA206NPC04

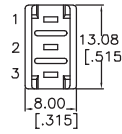
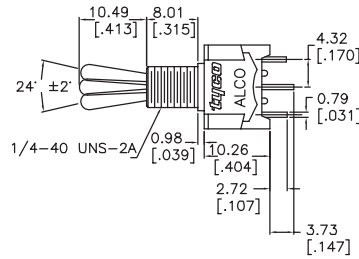

MTA106

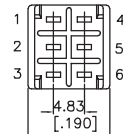

MTA206

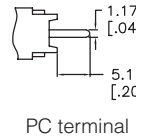

PC terminal

MTA3, MTA4 3 & 4 pole



MTA306D04 MTA406NPC04

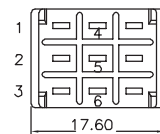
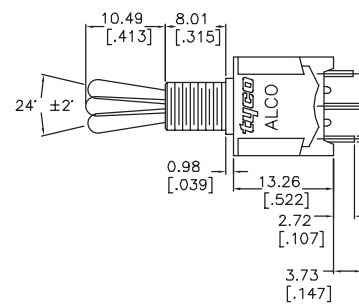

MTA306

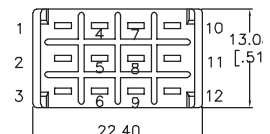

MTA406

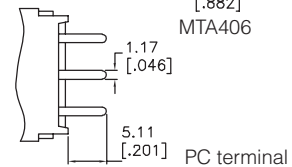

PC terminal

MTA81 RA 1pole, right angle



MTA8106DRA04

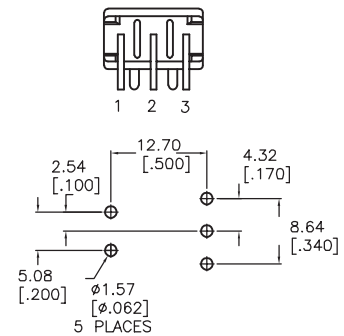
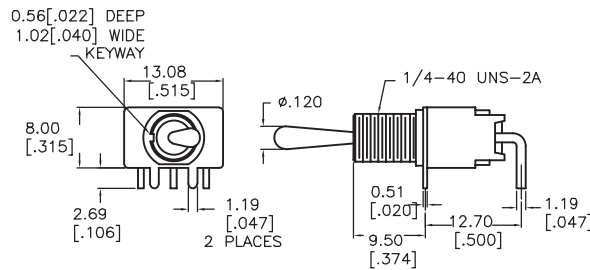

MTA82 RA 2pole, right angle



MTA8206NRA04

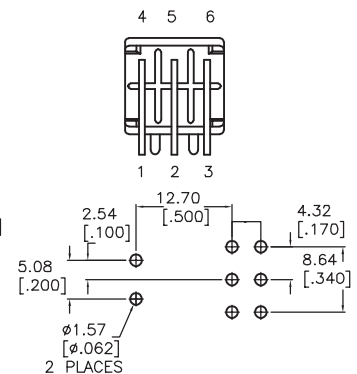
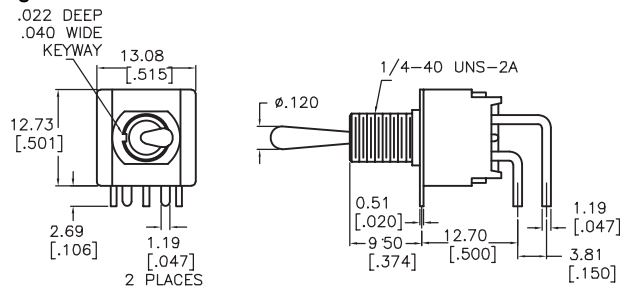

MT Green Series (Continued)

MTA81 VRA 1pole, vertical right angle



MTA8106DVRA04

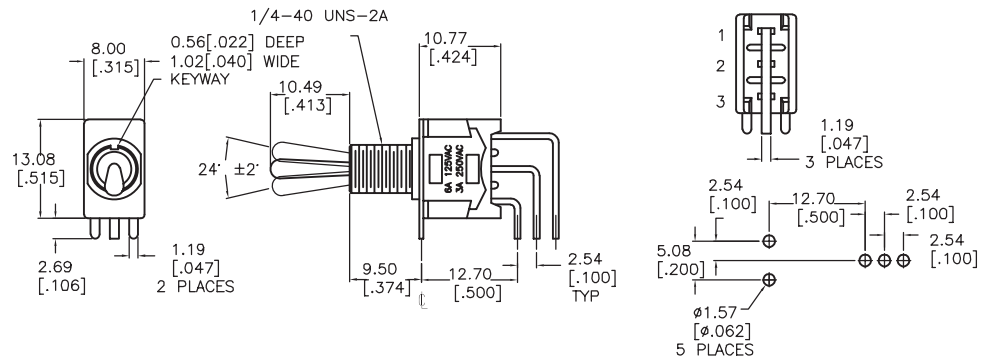

MTA82 VRA 2pole, vertical right angle



MTA8206NVRA04

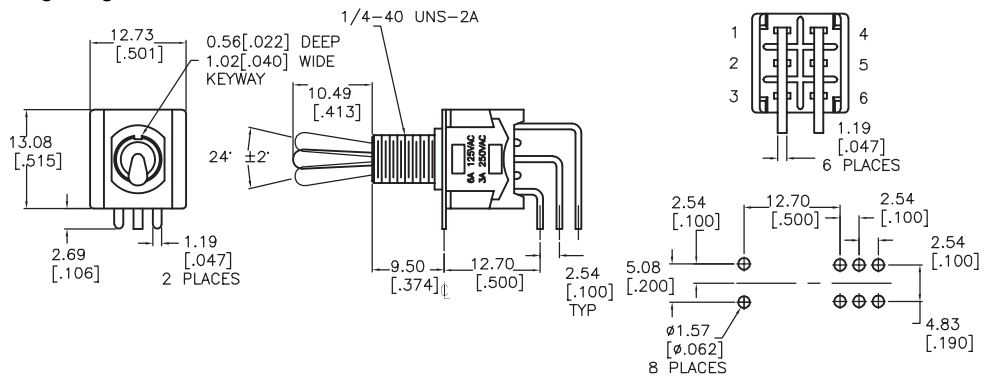

MTB



MTB1, MTB2 1 & 2 pole



MTB106D04



MTB206N04

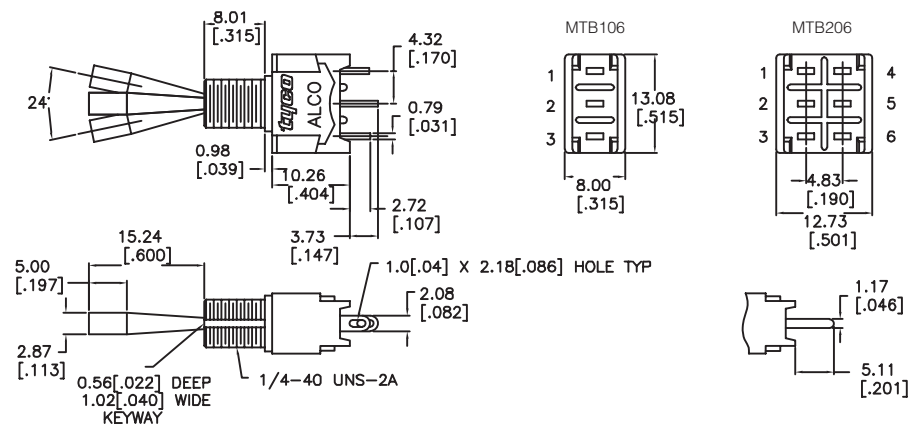

MT Green Series (Continued)

MTB3, MTB4 3 & 4 pole

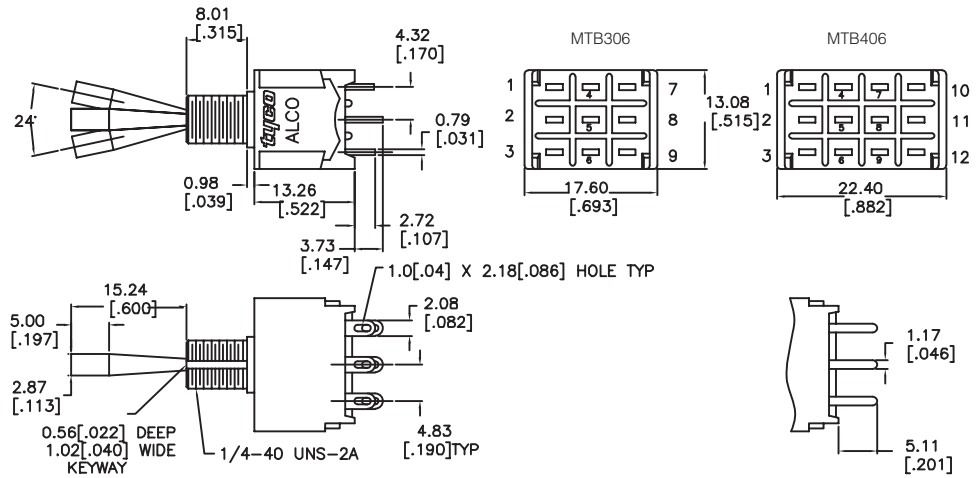

MTE

MTE1, MTE2 1 & 2 pole

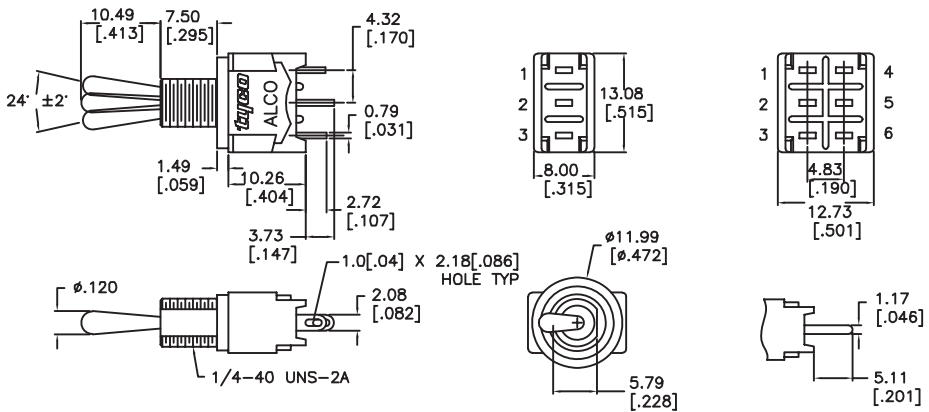

MTE3, MTE4 3 & 4 pole

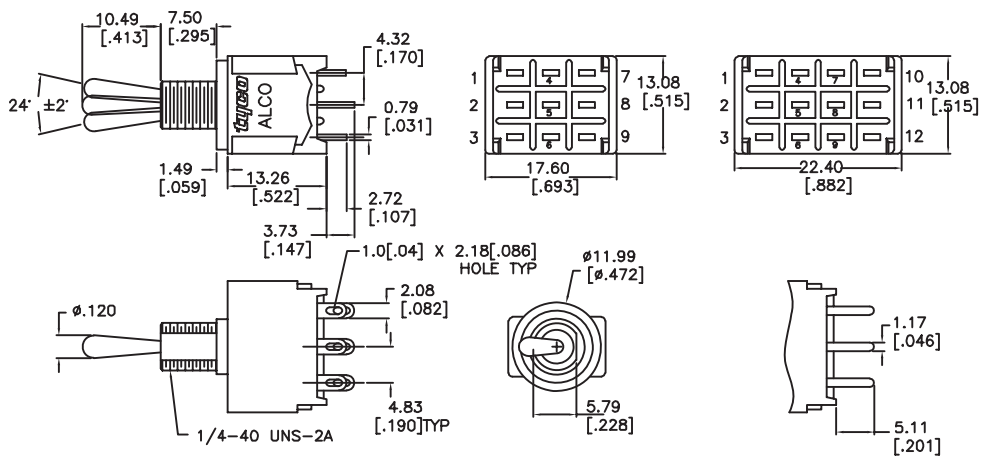

MT Green Series (Continued)

MTF

MTF1, MTF2 1 & 2 pole

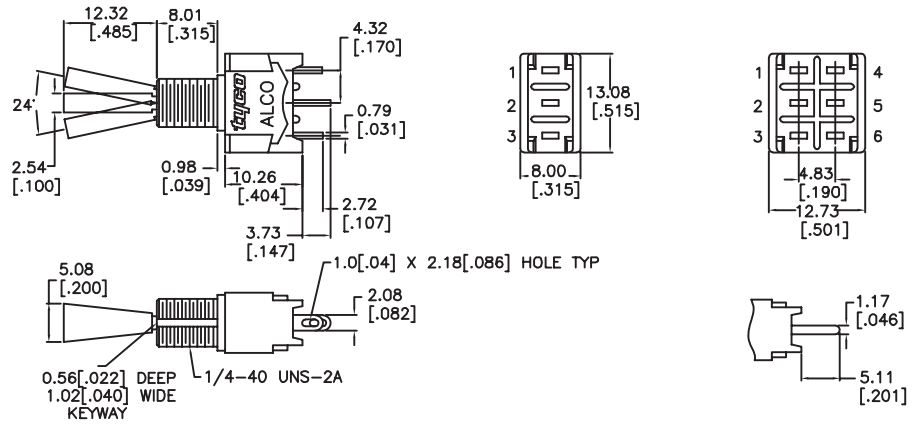

MTF3, MTF4 3 & 4 pole

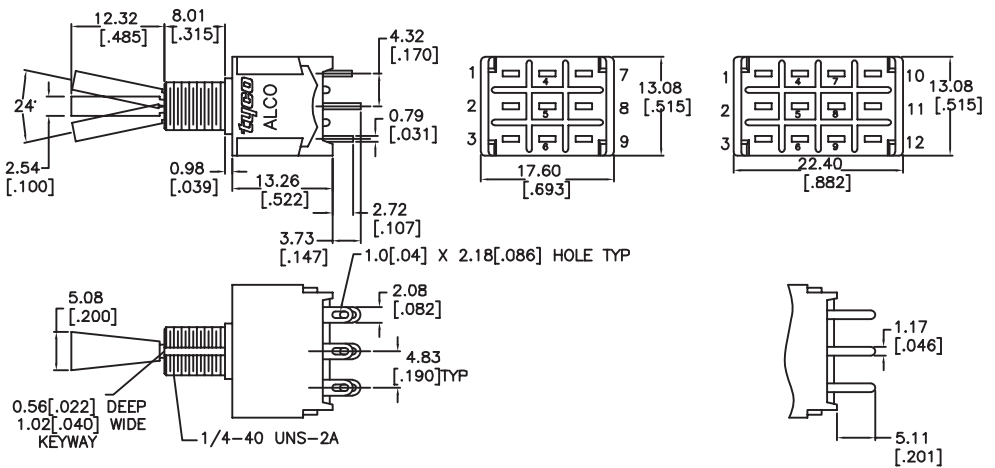

MTG

MTG1, MTG2 1 & 2 pole

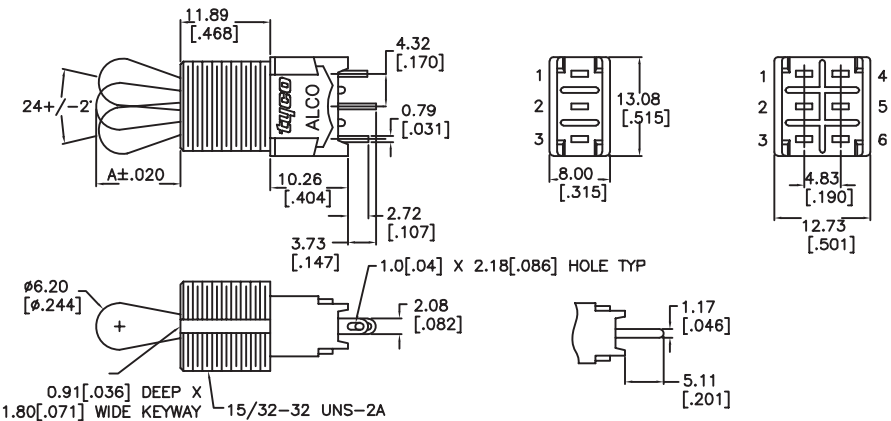

MT Green Series (Continued)

MTG3, MTG4 3 & 4 pole

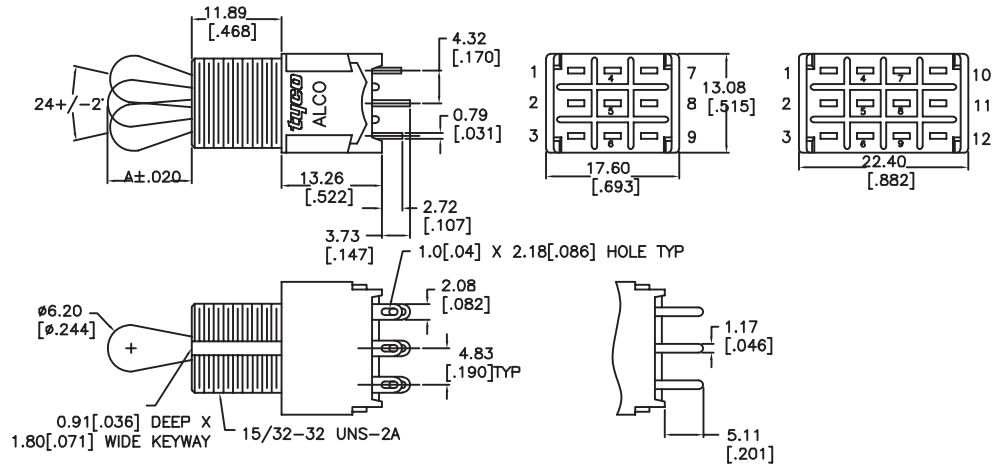

MTL

MTL1, MTL2 1 & 2 pole

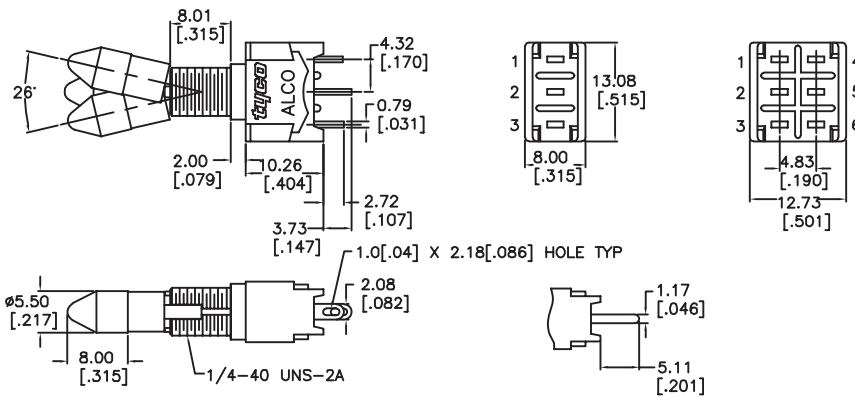

MTL3, MTL4 3 & 4 pole

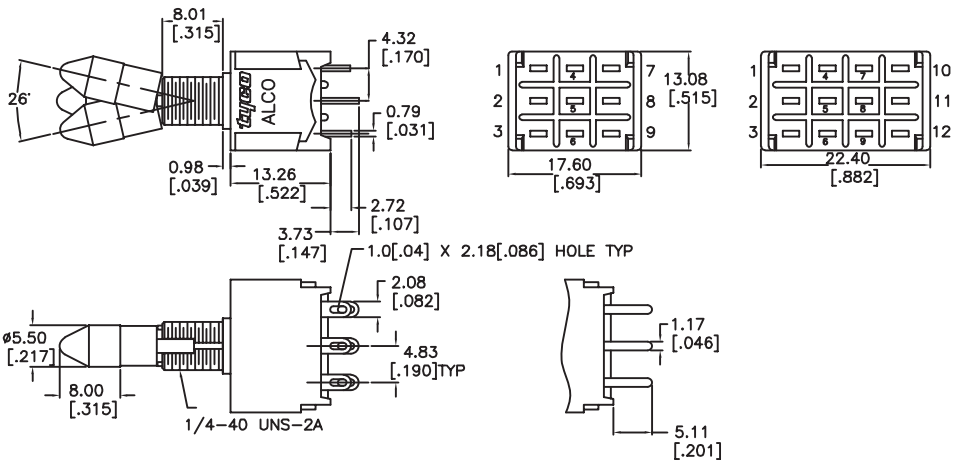

MT Green Series (Continued)

MTM81 VRA 1pole, vertical right angle



MTM8106DVRA04

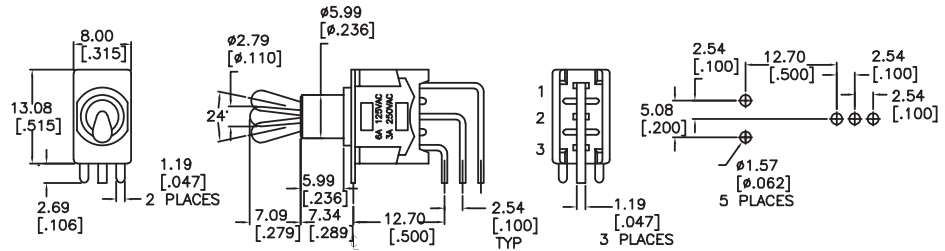

MTM82 VRA 2pole, vertical right angle



MTM8206NVRA04

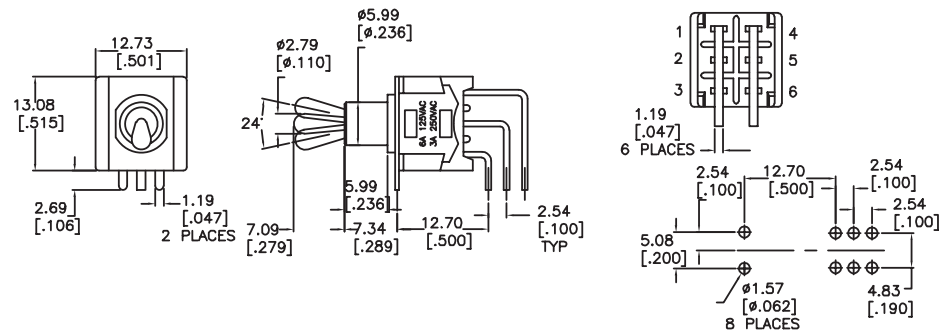

Function



Function	Poles	Throws	↙	↓	↘	↙	↓	↘
A	1	1	On	None	Off	2-3	-	Off
D	1	2	On	None	On	2-3	-	2-1
D	3	2	On	None	On	2-3, 5-6, 8-9	-	2-1, 5-4, 8-7
E	1	2	On	Off	On	2-3	Off	2-1
E	3	2	On	Off	On	2-3, 5-6, 8-9	Off	2-1, 5-4, 8-7
F	1	2	On	None	(On)	2-3	-	2-1
F	3	2	On	None	(On)	2-3, 5-6, 8-9	-	2-1, 5-4, 8-7
G	1	2	(On)	Off	(On)	2-3	Off	2-1
H	1	2	On	Off	(On)	2-3	Off	2-1
H	3	2	On	Off	(On)	2-3, 5-6, 8-9	Off	2-1, 5-4, 8-7
N	2	2	On	None	On	2-3, 5-6	-	2-1, 5-4
N	4	2	On	None	On	2-3, 5-6, 8-9, 11-12	-	2-1, 5-4, 8-7, 11-10
P	2	2	On	Off	On	2-3, 5-6	Off	2-1, 5-4
P	4	2	On	Off	On	2-3, 5-6, 8-9, 11-12	Off	2-1, 5-4, 8-7, 11-10
PA	1 ¹⁾	3	On	On	On	5-6	5-3	5-1
PA	2 ²⁾	3	On	On	On	5-6, 11-12	5-3, 11-9	5-1, 11-7
R	2	2	On	None	(On)	2-3, 5-6	-	2-1, 5-4
S	2	2	(On)	Off	(On)	2-3, 5-6	Off	2-1, 5-4
SA	1 ¹⁾	3	(On)	On	(On)	5-6	5-3	5-1
T	2	2	On	Off	(On)	2-3, 5-6	Off	2-1, 5-4
TA	1 ¹⁾	3	On	On	(On)	5-6	5-3	5-1

¹⁾ customer installed external jumper between terminals 1 and 4 required for 1 pole 3 throw function
²⁾ customer installed external jumpers between terminals 2 and 4 as well as between 8 and 10 required for 2 pole 3 throw function
 Off indicates a mechanical position with no electrical connection
 (On) indicates momentary connection
 None indicates no mechanical position

Mounting

PC board layout
 PC terminals only

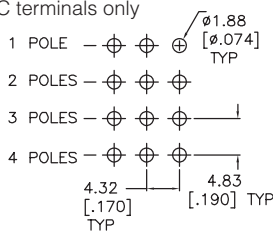

Recommended hole layout
 to prevent rotation

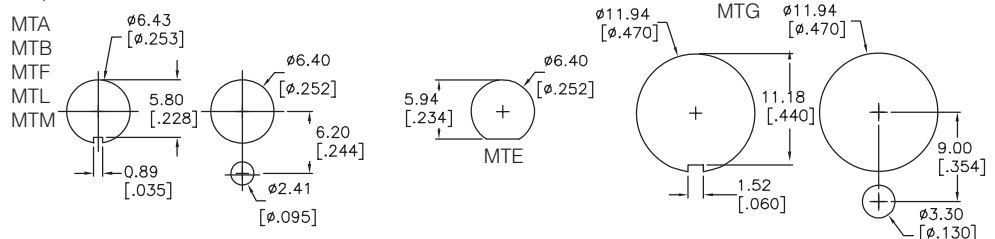

MT Green Series (Continued)

Toggle Switches

Product key	Toggle	Bushing	Poles	Terminations	Material	Part Number	
MTA106D04	.410 round	1/4-40 bushing	1	wire lug	RoHS compliant	1571920-3	
MTA106DPC04				pc board		1571920-4	
MTA106E04				wire lug		1571920-5	
MTA106EPC04			pc board	1571920-6			
MTA106F04			wire lug	1571920-7			
MTA106FPC04			pc board	1571920-8			
MTA106G04			wire lug	1571920-9			
MTA106GPC04			pc board	1-1571920-0			
MTA106H04			wire lug	1-1571920-1			
MTA106HPC04			pc board	1-1571920-2			
MTA206N04			2	wire lug		1-1571920-5	
MTA206NPC04				pc board		1-1571920-6	
MTA206P04				wire lug		1-1571920-7	
MTA206PA04			1	pc board		1-1571920-8	
MTA206PAPC04						1-1571920-9	
MTA206PPC04			2	pc board		2-1571920-0	
MTA206R04				wire lug		2-1571920-1	
MTA206RPC04			pc board	2-1571920-2			
MTA206S04			1	wire lug		2-1571920-3	
MTA206SA04				2-1571920-4			
MTA206SAPC04				pc board		2-1571920-5	
MTA206SPC04			2	wire lug		2-1571920-6	
MTA206T04						2-1571920-7	
MTA206TA04			1	2-1571920-8			
MTA206TPC04			2	pc board		2-1571920-9	
MTA306D04			3	wire lug		3-1571920-0	
MTA306DPC04						3-1571920-1	
MTA306E04	3-1571920-2						
MTA306EPC04	3-1571920-3						
MTA306F04	wire lug	3-1571920-4					
MTA306FFPC04	pc board	3-1571920-5					
MTA306H04	wire lug	3-1571920-6					
MTA306HPC04	pc board	3-1571920-7					
MTA406N04	4	wire lug			3-1571920-8		
MTA406NPC04		pc board			3-1571920-9		
MTA406P04		wire lug			4-1571920-0		
MTA406PA04	2	pc board			4-1571920-1		
MTA406PAPC04					4-1571920-2		
MTA406PPC04					4-1571920-3		
MTA8106DGVRA04	1	vertical r.a.			1571922-3		
MTA8106DRA04			1571922-4				
MTA8106DVRA04			vertical r.a.	1571922-5			
MTA8106EGRA04			right angle	1571922-6			
MTA8106EGVRA04			vertical r.a.	1571922-7			
MTA8106ERA04			1571922-8				
MTA8106EVRA04			vertical r.a.	1571922-9			
MTA8106FRA04			right angle	1-1571922-0			
MTA8106FVRA04			vertical r.a.	1-1571922-1			
MTA8206NRA04			2	right angle	1-1571922-4		
MTA8206NVRA04				vertical r.a.	1-1571922-5		
MTA8206PGVRA04				1-1571922-6			
MTA8206PRA04			right angle	1-1571922-7			
MTA8206PVRA04			vertical r.a.	1-1571922-8			
MTA8206RRA04			right angle	1-1571922-9			
MTB106D04			.600 round, w plastic tip	1/4-40 bushing	1	wire lug	1571923-3
MTB106E04						1571923-4	
MTB106F04						1571923-5	
MTB106G04	2	1571923-6					
MTB206N04		1571923-9					
MTB206P04		1-1571923-0					
MTB206T04	3	1-1571923-1					
MTB306D04		1-1571923-2					
MTB406N04		4			1-1571923-3		

Preferred parts in bold print

MT Green Series (Continued)

Product key	Toggle	Bushing	Poles	Terminations	Material	Part Number
MTE106D04	.410 round	1/4-40, O-ring seal	1	wire lug		1571924-3
MTE106E04						1571924-4
MTE106F04						1571924-5
MTE106G04						1571924-6
MTE106H04						1571924-7
MTE206N04			2			1-1571924-0
MTE206P04						1-1571924-1
MTE206PA04			1			1-1571924-2
MTE206R04			2			1-1571924-3
MTE206S04						1-1571924-4
MTE206T04						1-1571924-5
MTE306D04			3			1-1571924-6
MTE306E04						1-1571924-7
MTE406N04			4			1-1571924-8
MTE406P04						1-1571924-9
MTF106D04	.485 flat	1/4-40 bushing	1			1571925-3
MTF106E04						1571925-4
MTF106F04						1571925-5
MTF106G04						1571925-6
MTF106H04						1571925-7
MTF126D04						1-1571925-0
MTF126E04						1-1571925-1
MTF126F04						1-1571925-2
MTF126G04						1-1571925-3
MTF206N04			2			1-1571925-6
MTF206P04						1-1571925-7
MTF206PA04			1			1-1571925-8
MTF206R04			2			1-1571925-9
MTF206S04						2-1571925-0
MTF206SA04			1			2-1571925-1
MTF206T04			2			2-1571925-2
MTF226N04						2-1571925-5
MTF226P04						2-1571925-6
MTF226PA04			1			2-1571925-7
MTF226R04			2			2-1571925-8
MTF226S04						2-1571925-9
MTF226SA04			1			3-1571925-0
MTF306D04			3			3-1571925-1
MTF326D04						3-1571925-2
MTF406N04			4			3-1571925-3
MTF426N04						3-1571925-4
MTG106D04	.452 large diam. round	15/32 bushing	1			1571926-3
MTG106E04						1571926-4
MTG106F04						1571926-5
MTG106G04						1571926-6
MTG106H04						1571926-7
MTG126D04	.685 large diam. round	15/32 bushing				1-1571926-0
MTG126E04						1-1571926-1
MTG126G04						1-1571926-2
MTG206N04	.452 large diam. round	15/32 bushing	2			1-1571926-5
MTG206NPC04				pc board		1-1571926-6
MTG206P04				wire lug		1-1571926-7
MTG206PA04			1			1-1571926-8
MTG206R04			2			1-1571926-9
MTG206S04						2-1571926-0
MTG206T04						2-1571926-1
MTG226N04	.685 large diam. round	15/32 bushing				2-1571926-4
MTG226P04						2-1571926-5
MTG226PA04			1			2-1571926-6
MTG306D04	.452 large diam. round	15/32 bushing	3			2-1571926-7
MTG306E04						2-1571926-8
MTG326D04	.685 large diam. round	15/32 bushing				2-1571926-9
MTG406N04	.452 large diam. round	15/32 bushing	4			3-1571926-0
MTG406P04						3-1571926-1
MTG426N04	.685 large diam. round	15/32 bushing				3-1571926-2

Preferred parts in bold print

MT Green Series (Continued)

Product key	Toggle	Bushing	Poles	Terminations	Material	Part Number
MTL106D04	locking	1/4-40 bushing	1	wire lug		1571927-2
MTL106E04						1571927-3
MTL206N04			2			1571927-5
MTL206NPC04				pc board		1571927-6
MTL206P04				wire lug		1571927-7
MTL206PA04			1			1571927-8
MTL206S04			2			1571927-9
MTL306D04			3			1-1571927-0
MTL306E04						1-1571927-1
MTL406N04			4			1-1571927-2
MTL406PA04			2			1-1571927-3
MTM106DPC04	.270 round	1/4-40 bushing	1	pc board		1571921-2
MTM106EPC04						1571921-3
MTM106FPC04						1571921-4
MTM206NPC04			2			1571921-6
MTM206PAPC04			1			1571921-7
MTM206PPC04			2			1571921-8
MTM206SPC04						1571921-9
MTM306DPC04			3			1-1571921-0
MTM406NPC04			4			1-1571921-1
MTM8106DGRA04			1	right angle		2-1571922-2
MTM8106DRA04						2-1571922-3
MTM8106DVRA04				vertical r.a.		2-1571922-4
MTM8106ERA04				right angle		2-1571922-5
MTM8106EVRA04				vertical r.a.		2-1571922-6
MTM8106FRA04				right angle		2-1571922-7
MTM8206NRA04			2	right angle		3-1571922-0
MTM8206NVRA04				vertical r.a.		3-1571922-1
MTM8206PRA04				right angle		3-1571922-2
MTM8206PVRA04				vertical r.a.		3-1571922-3
MTM8206RRA04				right angle		3-1571922-4
MTM8206RVRA04				vertical r.a.		3-1571922-5

Toggle Switches

F Series, Power Toggle, Panel Mounting, 6A

Features

- Wide choice of toggles
- Wide range switch functions available
- Terminals are gold-flashed to prevent oxidation and for ease of soldering
- Up to 4 poles



Typical performance characteristics

Number of poles 1 to 4 pole
 Switch functions ON-ON, ON-(ON), ON-OFF-ON, ON-ON-ON, ON-OFF-(ON), (ON)-OFF-(ON)
 Contact rating 6 A @250 VAC, 6 A @125 VAC; gold contact: 0,4 VA max 20 V AC/DC
 Electrical life 25,000 to 50,000 cycles
 Mechanical life 50,000 to 100,000 cycles
 Contact resistance max 10 mOhm
 Insulation resistance min 1,000 MOhm
 Dielectric strength 1,000 VAC for 1 min
 Actuation force max 19,6 N
 Panel cut-out Ø 6,2 mm
 Standards and specs UL, CSA

Environmental specification

Operating temperature -20 to +70°C
 Storage temperature -20 to +70°C
 Vibration resistance 1,5 mm 10-55 Hz
 Shock resistance 50 g for 11±1 msec
 Terminal strength 24,5 N

Material specifications

Contacts brass silver alloy finished
 Toggle brass chromium plated
 Terminals brass plate
 Case phenol resin
 Cover steel zinc plated
 Seal rubber seal, insert molded rubber
 RoHS compliance compliant

Product key	Typical product key		F	T	D	0	9	04
Type	F Series power toggle switch							
Number of poles	blank	1 & 2 pole	3	3 poles				
			4	4 poles				
Model	toggle							
Switch function & poles	1 & 3 Pole		2 & 4 Pole					
	D	ON-ON	N	ON-ON				
	E	ON-OFF-ON	P	ON-OFF-ON				
	F	ON-(ON)	R	ON-(ON)				
	G	(ON)-OFF-(ON)	S	(ON)-OFF-(ON)				
	H	ON-OFF-(ON)	T	ON-OFF-(ON)				
			PA	ON-ON-ON				
Actuator	0	standard toggle	7	long flat toggle				
	5	locking lever						
Terminal type	leadwire hooking type							
Contact material	blank	silver	G	gold				
Material	RoHS compliant							

F Series, Power Toggle, Panel Mounting, 6A (Continued)

Function



Code 0 standard toggle

Fct.	Poles	↙	↓	↘	↙	↓	↘
D	1	On	None	On	1-2	-	2-3
E	1	On	Off	On	1-2	Off	2-3
F	1	On	None	(On)	1-2	-	2-3
G	1	(On)	Off	(On)	1-2	Off	2-3
H	1	On	Off	(On)	1-2	Off	2-3
N	2	On	None	On	1-2, 4-5	-	2-3, 5-6
P	2	On	Off	On	1-2, 4-5	Off	2-3, 5-6
R	2	On	None	(On)	1-2, 4-5	-	2-3, 5-6
S	2	(On)	Off	(On)	1-2, 4-5	Off	2-3, 5-6
T	2	On	Off	(On)	1-2, 4-5	Off	2-3, 5-6
PA	2	On	On	On	1-2, 4-5	2-3, 4-5	2-3, 5-6
D	3	On	None	On	1-2, 4-5, 7-8	-	2-3, 5-6, 8-9
N	4	On	None	On	1-2, 4-5, 7-8, 10-11	-	2-3, 5-6, 8-9, 11-12
PA	4	On	On	On	1-2, 4-5, 7-8, 10-11	2-3, 4-5, 7-8, 11-12	2-3, 5-6, 8-9, 11-12

Offi indicates a mechanical position with no electrical connection
 (On) indicates momentary connection
 None indicates no mechanical position

Actuator



Code 0 standard toggle



FTD0904

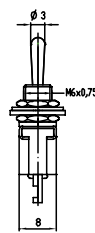
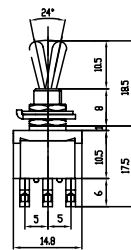

1 pole

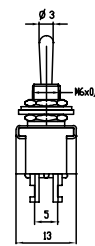

2 pole

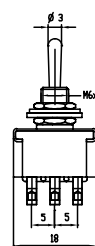
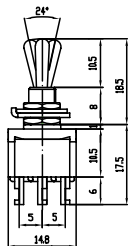
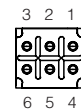

3 pole

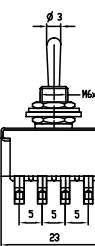
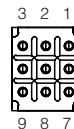

4 pole

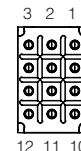

Code 5 locking lever

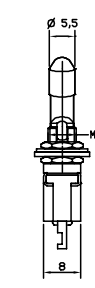
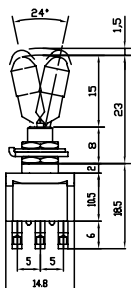

1 pole

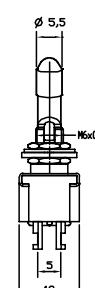

2 pole

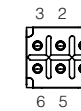

F Series, Power Toggle, Panel Mounting, 6A (Continued)

Code 7 long flat toggle

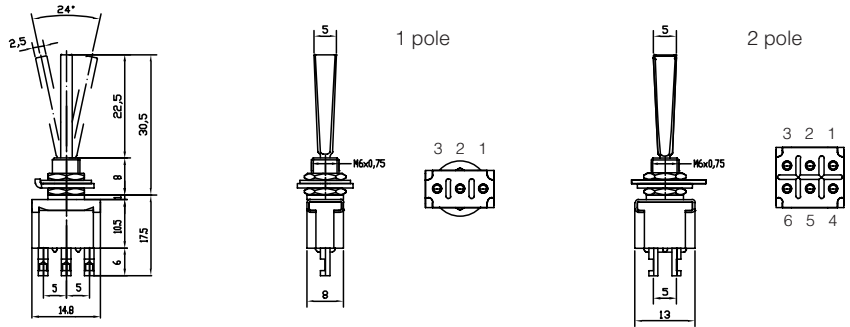

Terminal



Code 9 leadwire hooking type

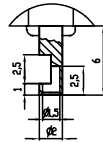

Mounting

Recommended hole layout to prevent rotation

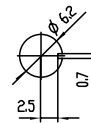

Panel Cutout using Ring

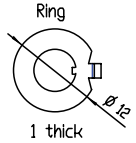

Product key	Poles	Switch func.	Actuator	Terminal	Contacts	Material	Part Number
F3TD0904	3 poles	ON-ON	standard	leadwire	silver	RoHS	2-6437630-8
F4TN0904	4 poles			hooking		compliant	3-6437630-5
F4TPA0904		ON-ON-ON		type			3-6437630-6
FTD0904	1 pole	ON-ON	standard				2-6437630-0
FTD09G04					gold		3-6437630-4
FTD5904			locking lever		silver		1-6437630-5
FTD59G04					gold		4-6437630-0
FTD7904			flat toggle		silver		5-6437630-3
FTD79G04					gold		5-6437630-4
FTE0904		ON-OFF-ON	standard		silver		6-6437630-2
FTE09G04					gold		5-6437630-1
FTE79G04			flat toggle				5-6437630-8
FTF0904		ON-(ON)	standard		silver		5-6437630-7
FTF09G04					gold		6-6437630-3
FTG0904		(ON)-OFF-(ON)			silver		5-6437630-5
FTG09G04					gold		3-6437630-8
FTH0904		ON-OFF-(ON)			silver		4-6437630-8
FTH09G04					gold		6-6437630-4
FTN0904	2 poles	ON-ON			silver		4-6437630-2
FTN09G04					gold		6-6437630-8
FTN5904			locking lever		silver		3-6437630-9
FTN59G04					gold		6-6437630-1
FTN7904			flat toggle		silver		5-6437630-2
FTN79G04					gold		5-6437630-9
FTP0904		ON-OFF-ON	standard		silver		4-6437630-6
FTPA0904							4-6437630-5
FTR0904		ON-(ON)					4-6437630-4
FTS0904		(ON)-OFF-(ON)					4-6437630-3
FTT0904		ON-OFF-(ON)					4-6437630-1

Preferred parts in bold print

AW Series, Power Toggle, Panel Mounting, Waterproof

Features

- IP67 panel mounting seal
- Sleeve and Frame are sealed.
- Fixed contact molded-inserting construction
- Wide range switch functions available



Typical performance characteristics

Number of poles 1,2 and 4 pole
 Switch functions ON-OFF, ON-ON, ON-(ON),
 ON-OFF-ON, ON-OFF-(ON), (ON)-OFF-(ON)
 Contact rating 20 A @250 VAC, 20 A @125 VAC, 20 A @30 VDC
 Electrical life 20,000 cycles
 Mechanical life 40,000 cycles
 Contact resistance max 10 mOhm
 Insulation resistance min 1,000 MOhm
 Dielectric strength 1,500 VAC for 1 min
 Actuation force max 29,4 N
 Panel cut-out D-cut, 12,5 mm
 Standards and specs UL, CSA

Environmental specification

Operating temperature -20 to +70°C
 Storage temperature -20 to +70°C
 Vibration resistance 1,5 mm 10-55 Hz
 Shock resistance 50 g for 11±1 msec
 Terminal strength 24,5 N

Material specifications

Contacts brass silver alloy finished
 Toggle brass chromium plated
 Case brass plate
 Terminals phenol resin
 Cover steel zinc plated
 Seal rubber seal, insert molded rubber
 RoHS compliance compliant

Toggle Switches

Product key	Typical product key							A	W	T	T	1	5	04																																																																																																								
Type	A A Series power toggle switch, 1 & 2 pole																																																																																																																					
Sealing	W water proof																																																																																																																					
Actuator style	T toggle																																																																																																																					
Switch function & poles	<table border="0" style="width: 100%;"> <tr> <td colspan="7">1 pole</td> <td colspan="7">2 pole</td> </tr> <tr> <td>A</td><td>ON-OFF</td><td></td><td></td><td></td><td></td><td></td> <td>N</td><td>ON-ON</td><td></td><td></td><td></td><td></td><td></td><td></td> </tr> <tr> <td>D</td><td>ON-ON</td><td></td><td></td><td></td><td></td><td></td> <td>P</td><td>ON-OFF-ON</td><td></td><td></td><td></td><td></td><td></td><td></td> </tr> <tr> <td>E</td><td>ON-OFF-ON</td><td></td><td></td><td></td><td></td><td></td> <td>R</td><td>ON-(ON)</td><td></td><td></td><td></td><td></td><td></td><td></td> </tr> <tr> <td>F</td><td>ON-(ON)</td><td></td><td></td><td></td><td></td><td></td> <td>S</td><td>(ON)-OFF(ON)</td><td></td><td></td><td></td><td></td><td></td><td></td> </tr> <tr> <td>G</td><td>(ON)-OFF(ON)</td><td></td><td></td><td></td><td></td><td></td> <td>T</td><td>ON-OFF-(ON)</td><td></td><td></td><td></td><td></td><td></td><td></td> </tr> <tr> <td>H</td><td>ON-OFF-(ON)</td><td></td><td></td><td></td><td></td><td></td> <td></td><td></td><td></td><td></td><td></td><td></td><td></td><td></td> </tr> </table>														1 pole							2 pole							A	ON-OFF						N	ON-ON							D	ON-ON						P	ON-OFF-ON							E	ON-OFF-ON						R	ON-(ON)							F	ON-(ON)						S	(ON)-OFF(ON)							G	(ON)-OFF(ON)						T	ON-OFF-(ON)							H	ON-OFF-(ON)													
1 pole							2 pole																																																																																																															
A	ON-OFF						N	ON-ON																																																																																																														
D	ON-ON						P	ON-OFF-ON																																																																																																														
E	ON-OFF-ON						R	ON-(ON)																																																																																																														
F	ON-(ON)						S	(ON)-OFF(ON)																																																																																																														
G	(ON)-OFF(ON)						T	ON-OFF-(ON)																																																																																																														
H	ON-OFF-(ON)																																																																																																																					
Power rating	1 20 A @ 125/250 VAC																																																																																																																					
Terminal type	5 .250 quick connect terminal																																																																																																																					
Material	04 RoHS compliant																																																																																																																					

AW Series, Power Toggle, Panel Mounting, Waterproof (Continued)

4 pole

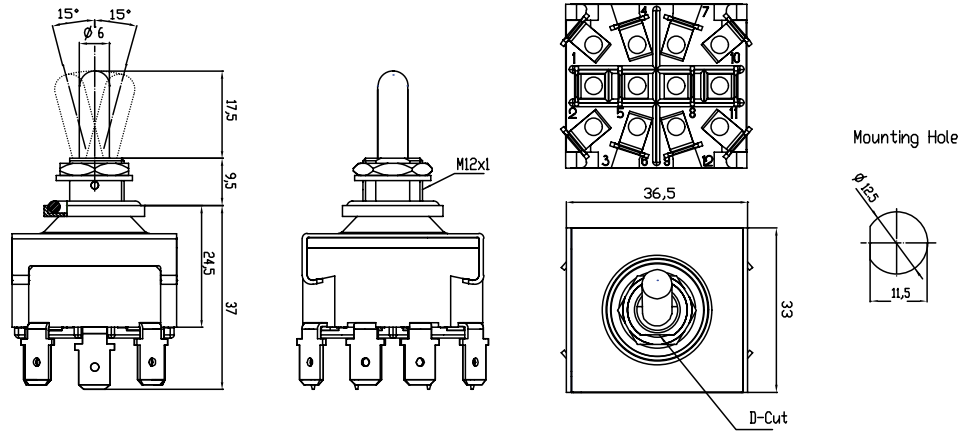

Function

Fct.	Poles	↕	⏚	↕	↕	↕	⏚	↕
A	1	On	None	Off		1-2	-	Off
D	1	On	None	On		1-2	-	2-3
E	1	On	Off	On		1-2	Off	2-3
F	1	On	None	(On)		1-2	-	2-3
G	1	(On)	Off	(On)		1-2	Off	2-3
H	1	On	Off	(On)		1-2	Off	2-3
N	2	On	None	On		1-2, 4-5	-	2-3, 5-6
P	2	On	Off	On		1-2, 4-5	Off	2-3, 5-6
R	2	On	None	(On)		1-2, 4-5	-	2-3, 5-6
S	2	(On)	Off	(On)		1-2, 4-5	Off	2-3, 5-6
T	2	On	Off	(On)		1-2, 4-5	Off	2-3, 5-6
K	4	On	None	Off		1-2, 4-5, 7-8, 10-11	-	Off
N	4	On	None	On		1-2, 4-5, 7-8, 10-11	-	2-3, 5-6, 8-9, 11-12
P	4	On	Off	On		1-2, 4-5, 7-8, 10-11	Off	2-3, 5-6, 8-9, 11-12
R	4	On	None	(On)		1-2, 4-5, 7-8, 10-11	-	2-3, 5-6, 8-9, 11-12
S	4	(On)	Off	(On)		1-2, 4-5, 7-8, 10-11	Off	2-3, 5-6, 8-9, 11-12

Off indicates a mechanical position with no electrical connection
 (On) indicates momentary connection
 None indicates no mechanical position

Product key	Sealing	Poles	Switch func.	Terminal	Rating	Part Number	
A4TK15W04	water	4 poles	ON-OFF	.250	20 A @ 125/250 VAC	8-6437630-0	
A4TN15W04	proof		ON-ON	quick		8-6437630-1	
A4TP15W04			ON-OFF-ON	connect		8-6437630-2	
A4TR15W04			ON-(ON)	terminal		8-6437630-3	
A4TS15W04		(ON)-OFF-(ON)			8-6437630-4		
AWTA1504		1 pole	ON-OFF			7-6437630-3	
AWTD1504			ON-ON			7-6437630-0	
AWTE1504			ON-OFF-ON			7-6437630-1	
AWTF1504			ON-(ON)			7-6437630-4	
AWTG1504			(ON)-OFF-(ON)			7-6437630-5	
AWTH1504			ON-OFF-(ON)			7-6437630-6	
AWTN1504			2 poles	ON-ON			7-6437630-2
AWTP1504				ON-OFF-ON			3-6437592-9
AWTR1504				ON-(ON)			5-6437630-0
AWTS1504				(ON)-OFF-(ON)			1-6437630-1
AWTT1504		ON-OFF-(ON)				1-6437630-0	

Preferred parts in bold print

Hardware and Accessories

Standard and decorative mounting hardware

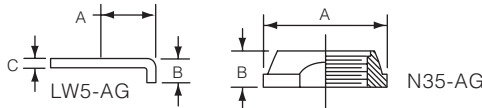
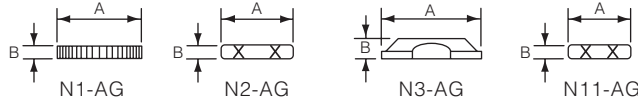

Fits all miniature toggle and pushbutton switches 1/4-40 and 15/32-32 bushings. N1 and N3 style nuts are recommended as styling options. Finger tighten until nut rests on mounting surface. Finally tighten with the back nut.

Product key	Description	Diameter/Thread	Finish	Dim A	Dim B	Material	Part Number
N1-AG	knurled nut	1/4-40	bright nickel	8.89 (.350)	1.52 (.060)	RoHS	1437628-7
10264-00-120	hex nut			7.87 (.310)	1.52 (.060)	compliant	1437561-9
N304	dress nut			11.7 (.460)	2.29 (.090)		1825621-1
N3504		15/32-32		16.0 (.630)	4.32 (.170)		1825621-2
11106-AG	hex nut	1/4-48		7.11 (.280)	1.27 (.050)		1-1437561-2
11052	int.lock washer	.27		10.2 (.400)	0.61 (.024)		1437579-1
11098	lck washer #10	.19	zinc	7.62 (.300)	0.76 (.030)		1-1437561-1

"Perfect Fit" decorative mounting hardware

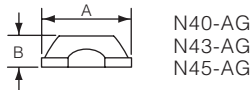
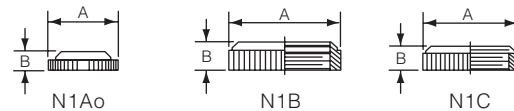

Use blind threaded nuts for ultimate appearance. Finger tighten until nut rests on mounting surface. Finally tighten with the back nut.

Product key	Description	Diameter/Thread	Finish	Dim A	Dim B	Material	Part Number
N1A04	knurled nut	1/4-40	bright nickel	7.87 (.310)	2.03 (.080)	RoHS	1825622-1
N1B04		15/32-32		14.2 (.560)	3.56 (.140)	compliant	1825622-2
N4004	dress nut	1/4-40	matte nickel	9.52 (.375)	3.10 (.122)		1825623-1
N4304			bright nickel	3.10 (.122)	9.52 (.375)		1825623-2
N4504		15/32-32		4.32 (.170)	16.0 (.630)		1825623-3

Toggle switch, legend plate



SPA32

Constructed of .025 gauge brushed aluminum with a matte black enamel.

Easily readable and aesthetically attractive.

Product key	Description	Diameter/Thread	Finish	Dim A	Dim B	Material	Part Number
SPA32	On-Off	1/4"	clear lacquer	9.52 (.375)	22.4 (.880)	RoHS	2-1437628-4
SPA42		15/32"		17.3 (.680)	28.6 (1.12)	compliant	2-1437628-6

Boot Seals

Features

- One piece design, nut over molded "bonded" to silicone boot element and 'O' ring
- Silicone rubber eliminates cure dates
- Protects against moisture, oil, dirt, dust, most solvents and some acids
- Multiple colors available



Environmental specification

Operating temperature -65°C to 265°C

Material specifications

Boot material silicone rubber
 Threaded nut material, and finish..... brass nut, black oxide finish

Toggle Switches

Product key		Typical product key		BT	1532	2	04
Type	Full boot seals BT Half boot seals *) *)Half boot recommended for maintained switch's as full boot may have tendency to pull toggle back						
Nut thread	1048 10-48 UNS 2-B 1440 1/4-40 UNS 2-B 1532 15/32-32 UNS 2-B						
Color	0 black	2 red	8 gray				
Material	04 RoHS compliant						

Full boots



1532 Series



B1532004

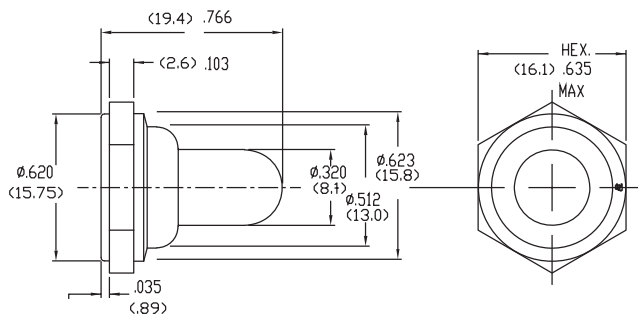

1048 Series



B1048004

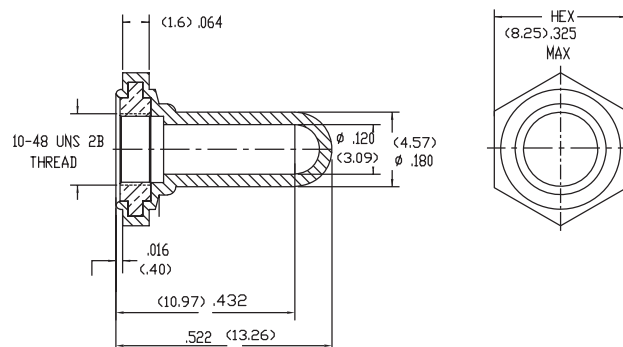

Boot Seals (Continued)

1440 Series



B1440004

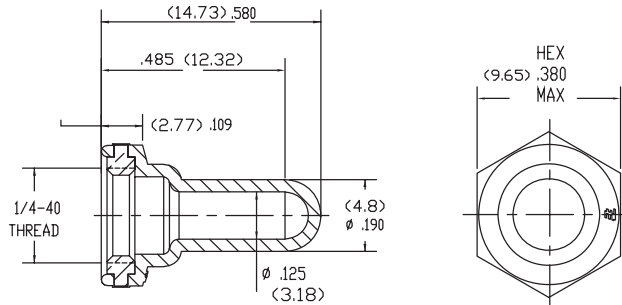

Half boots



1532 Series

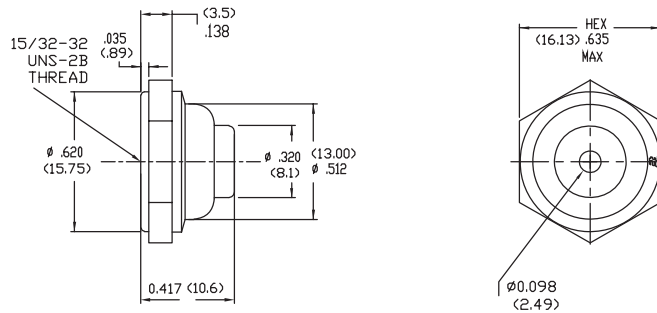

1440 Series

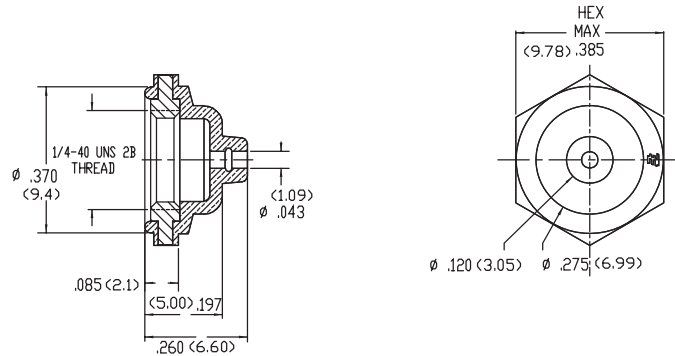

Product key	Used on switch type	Nut thread	Color	Material	Part Number
Full boot					
B1532004	MTG	15/32-32 UNS 2-B	black	RoHS compliant	1825602-1
B1532204			red		1825602-2
B1532804			gray		1825602-3
B1048004	TT Series	10-48 UNS 2-B	black		1825609-1
B1048204			red		1825609-2
B1048804			gray		1825609-3
B1440004	TT,MTA,Gemini	1/4-40 UNS 2-B	black		1825612-1
B1440204			red		1825612-2
B1440804			gray		1825612-3
Half boot					
BT1532004	MTG Series	15/32-32 UNS 2-B	black	RoHS compliant	1825600-1
BT1532204			red		1825600-2
BT1532804			gray		1825600-3
BT1440004	TT, MTA, Gemini	1/4-40 UNS 2-B	black		1825619-1



Компания «ЭлектроПласт» предлагает заключение долгосрочных отношений при поставках импортных электронных компонентов на взаимовыгодных условиях!

Наши преимущества:

- Оперативные поставки широкого спектра электронных компонентов отечественного и импортного производства напрямую от производителей и с крупнейших мировых складов;
- Поставка более 17-ти миллионов наименований электронных компонентов;
- Поставка сложных, дефицитных, либо снятых с производства позиций;
- Оперативные сроки поставки под заказ (от 5 рабочих дней);
- Экспресс доставка в любую точку России;
- Техническая поддержка проекта, помощь в подборе аналогов, поставка прототипов;
- Система менеджмента качества сертифицирована по Международному стандарту ISO 9001;
- Лицензия ФСБ на осуществление работ с использованием сведений, составляющих государственную тайну;
- Поставка специализированных компонентов (Xilinx, Altera, Analog Devices, Intersil, Interpoint, Microsemi, Aeroflex, Peregrine, Syfer, Eurofarad, Texas Instrument, Miteq, Cobham, E2V, MA-COM, Hittite, Mini-Circuits, General Dynamics и др.);

Помимо этого, одним из направлений компании «ЭлектроПласт» является направление «Источники питания». Мы предлагаем Вам помощь Конструкторского отдела:

- Подбор оптимального решения, техническое обоснование при выборе компонента;
- Подбор аналогов;
- Консультации по применению компонента;
- Поставка образцов и прототипов;
- Техническая поддержка проекта;
- Защита от снятия компонента с производства.



Как с нами связаться

Телефон: 8 (812) 309 58 32 (многоканальный)

Факс: 8 (812) 320-02-42

Электронная почта: org@eplast1.ru

Адрес: 198099, г. Санкт-Петербург, ул. Калинина, дом 2, корпус 4, литера А.