



SANYO Semiconductors

DATA SHEET

An ON Semiconductor Company

2SC5415A — High-Frequency Low-Noise Amplifier Applications

NPN Epitaxial Planar Silicon Transistor

Features

- High gain : $|S_{21e}|^2 = 9\text{dB typ (f=1GHz)}$
- High cut-off frequency : $f_T = 6.7\text{GHz typ}$

Specifications

Absolute Maximum Ratings at $T_a = 25^\circ\text{C}$

Parameter	Symbol	Conditions	Ratings	Unit
Collector-to-Base Voltage	V_{CBO}		20	V
Collector-to-Emitter Voltage	V_{CEO}		12	V
Emitter-to-Base Voltage	V_{EBO}		2	V
Collector Current	I_C		100	mA
Collector Dissipation	P_C	When mounted on ceramic substrate (250mm ² ×0.8mm)	800	mW
Junction Temperature	T_J		150	°C
Storage Temperature	T_{stg}		-55 to +150	°C

Package Dimensions

unit : mm (typ)

7007B-004

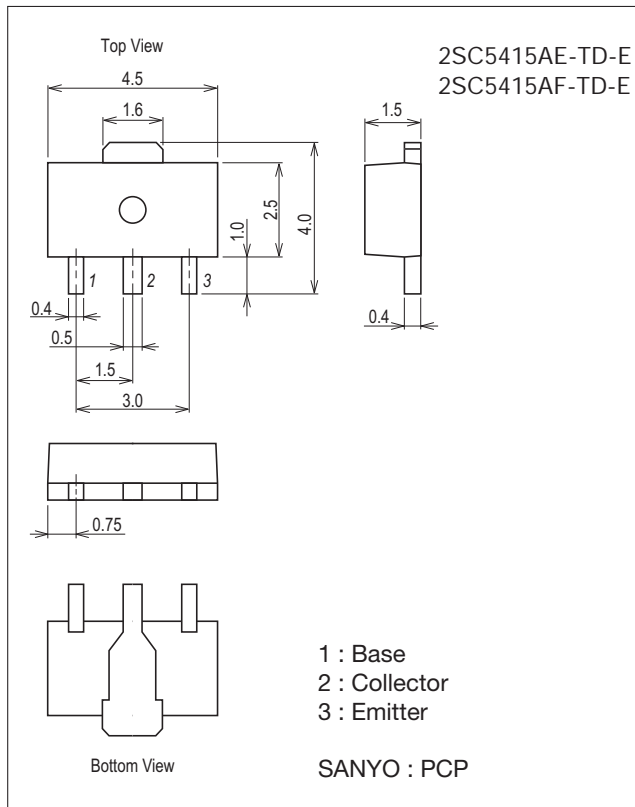

Product & Package Information

- Package : PCP
- JEITA, JEDEC : SC-62, SOT-89, TO-243
- Minimum Packing Quantity : 1,000 pcs./reel

Packing Type: TD

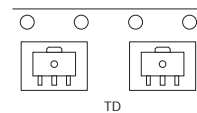

Marking

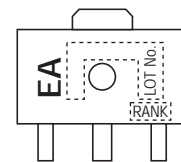

Electrical Connection

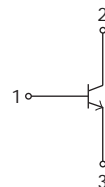

2SC5415A

Electrical Characteristics at Ta=25°C

Parameter	Symbol	Conditions	Ratings			Unit
			min	typ	max	
Collector Cutoff Current	I_{CBO}	$V_{CB}=10V, I_E=0A$			1.0	μA
Emitter Cutoff Current	I_{EBO}	$V_{EB}=1V, I_C=0A$			10	μA
DC Current Gain	h_{FE1}	$V_{CE}=5V, I_C=30mA$	90*		270*	
	h_{FE2}	$V_{CE}=5V, I_C=70mA$	70			
Gain-Bandwidth Product	f_T	$V_{CE}=5V, I_C=30mA$	5	6.7		GHz
Output Capacitance	C_{ob}	$V_{CB}=5V, f=1MHz$		1.2	1.8	pF
Reverse Transfer Capacitance	C_{re}			0.65		pF
Forward Transfer Gain	$ S_{21e} ^2$	$V_{CE}=5V, I_C=30mA, f=1GHz$	7.5	9		dB
Noise Figure	NF	$V_{CE}=5V, I_C=7mA, f=1GHz$		1.1	2.0	dB

* : The 2SC5415A is classified by 30mA h_{FE} as follows :

Rank	E	F
h_{FE}	90 to 180	135 to 270

Ordering Information

Device	Package	Shipping	memo
2SC5415AE-TD-E	PCP	1,000pcs./reel	Pb Free
2SC5415AF-TD-E	PCP	1,000pcs./reel	

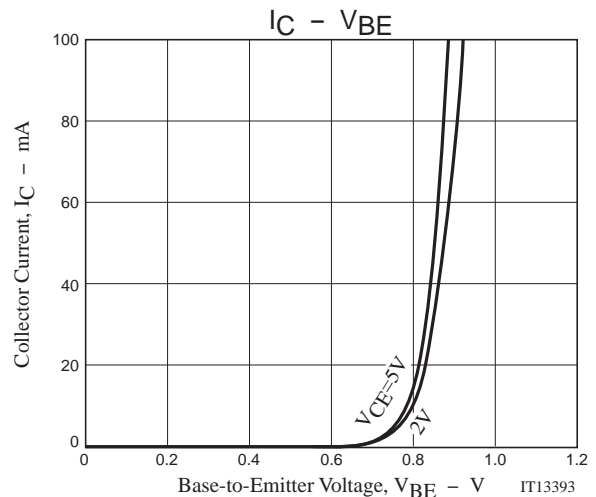
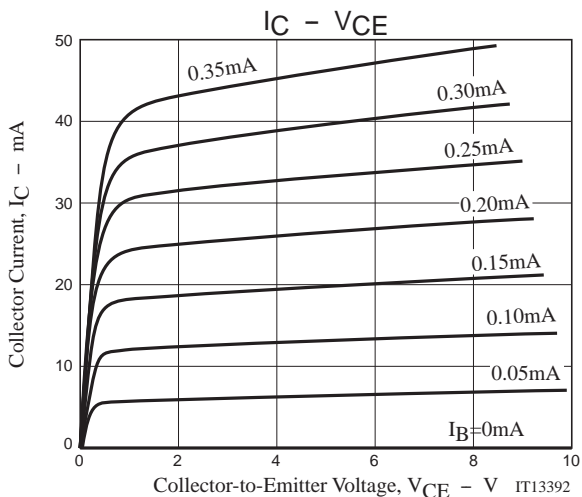

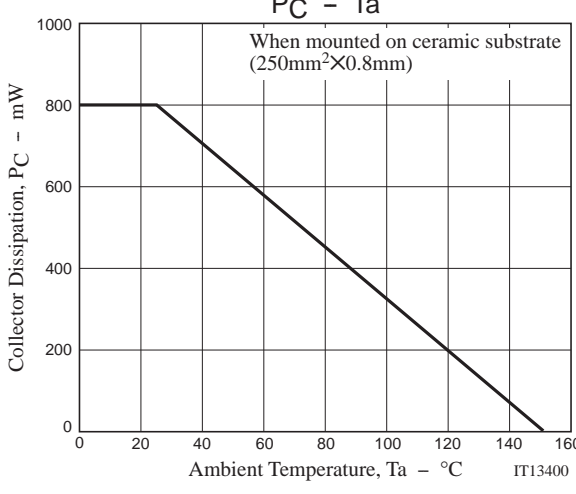
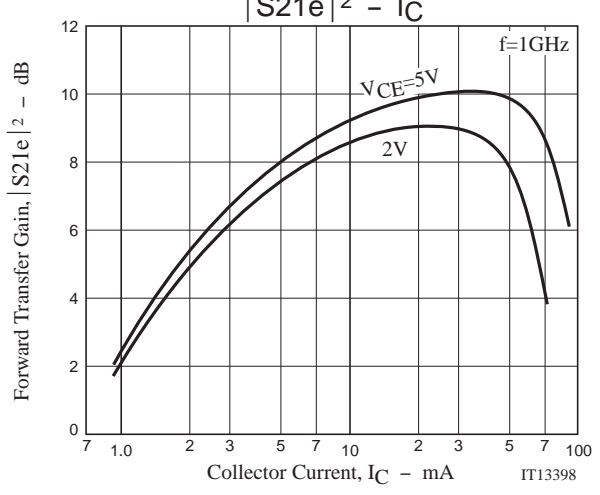
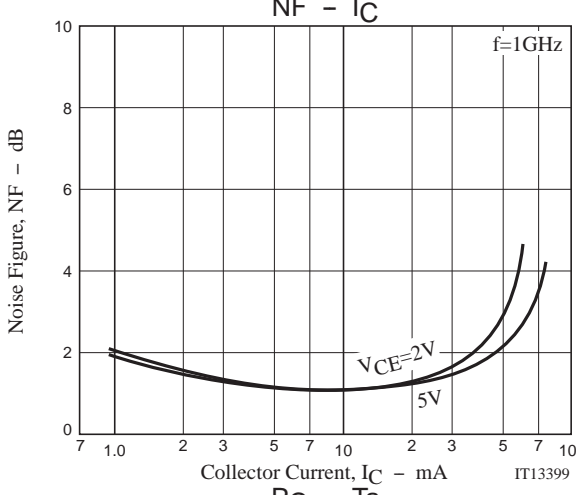
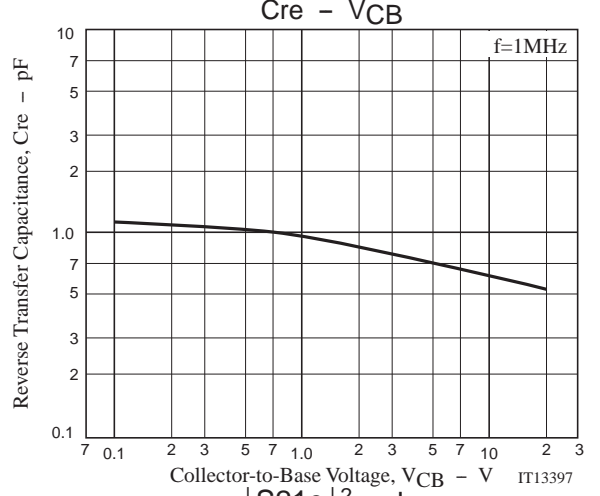
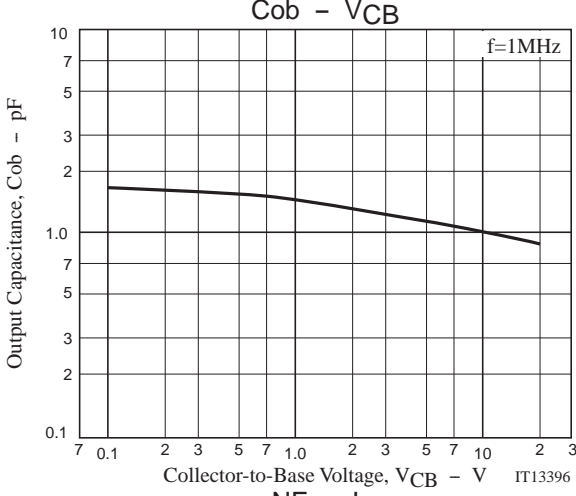
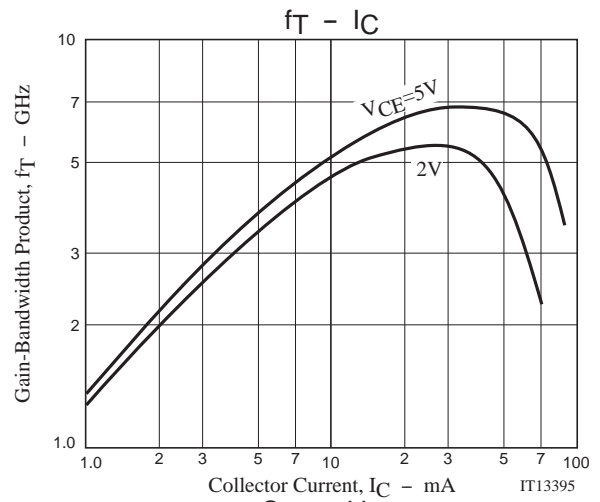
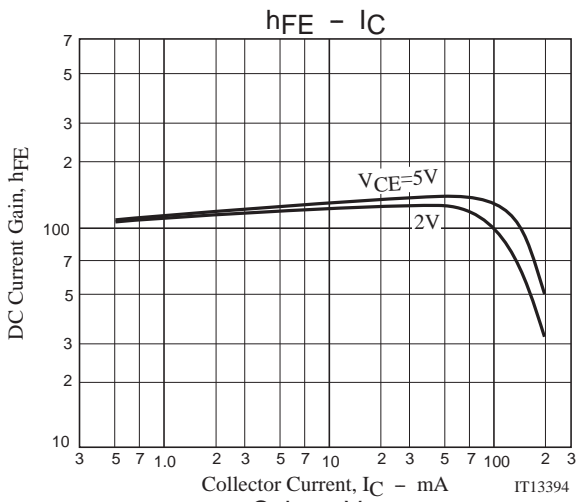

2SC5415A

S Parameters (Common emitter)

$V_{CE}=2V, I_C=5mA, Z_O=50\Omega$

Freq(MHz)	S11	$\angle S11$	S21	$\angle S21$	S12	$\angle S12$	S22	$\angle S22$
100	0.737	-51.3	11.929	142.2	0.046	65.0	0.836	-27.1
200	0.564	-86.8	8.854	118.5	0.070	54.3	0.649	-39.5
400	0.408	-129.5	5.231	95.2	0.097	51.5	0.454	-48.4
600	0.366	-155.0	3.667	82.0	0.121	53.7	0.394	-52.3
800	0.348	-175.8	2.811	70.0	0.147	55.3	0.370	-56.6
1000	0.338	169.4	2.332	62.6	0.175	56.2	0.368	-60.5
1200	0.346	156.6	2.000	54.2	0.205	55.7	0.361	-66.7
1400	0.350	145.7	1.739	47.3	0.235	54.9	0.363	-72.2
1600	0.360	136.1	1.557	40.6	0.267	53.7	0.371	-77.7
1800	0.365	126.2	1.428	34.4	0.300	51.7	0.383	-83.4
2000	0.369	116.9	1.306	29.3	0.334	49.2	0.385	-89.5

$V_{CE}=2V, I_C=10mA, Z_O=50\Omega$

Freq(MHz)	S11	$\angle S11$	S21	$\angle S21$	S12	$\angle S12$	S22	$\angle S22$
100	0.580	-67.4	17.590	130.8	0.040	62.8	0.715	-36.9
200	0.414	-104.9	11.116	109.3	0.059	58.5	0.490	-48.3
400	0.311	-145.7	6.099	90.2	0.091	60.9	0.338	-53.5
600	0.291	-168.2	4.213	79.2	0.125	62.4	0.294	-56.9
800	0.286	172.9	3.212	69.7	0.159	61.8	0.279	-61.6
1000	0.281	159.6	2.634	62.4	0.194	60.3	0.277	-65.9
1200	0.292	148.3	2.248	54.9	0.228	57.7	0.281	-71.7
1400	0.297	138.5	1.973	48.5	0.261	55.2	0.284	-77.2
1600	0.305	129.7	1.767	42.4	0.295	52.6	0.290	-82.7
1800	0.311	120.5	1.605	36.4	0.328	49.6	0.297	-88.5
2000	0.313	111.7	1.473	31.2	0.362	46.3	0.303	-93.9

$V_{CE}=2V, I_C=20mA, Z_O=50\Omega$

Freq(MHz)	S11	$\angle S11$	S21	$\angle S21$	S12	$\angle S12$	S22	$\angle S22$
100	0.432	-85.5	21.435	121.4	0.034	63.6	0.585	-45.4
200	0.313	-123.5	12.390	102.7	0.052	64.6	0.375	-54.0
400	0.263	-160.5	6.547	87.0	0.090	67.4	0.260	-57.1
600	0.257	-179.7	4.481	77.4	0.129	67.0	0.231	-60.9
800	0.260	163.3	3.408	68.8	0.168	64.8	0.224	-66.3
1000	0.258	151.6	2.792	62.1	0.206	62.3	0.224	-70.9
1200	0.271	141.6	2.378	55.1	0.243	58.7	0.231	-77.2
1400	0.270	133.1	2.085	49.1	0.278	55.4	0.236	-82.9
1600	0.282	124.5	1.867	43.2	0.313	52.2	0.242	-88.4
1800	0.288	115.4	1.697	37.5	0.346	48.7	0.249	-94.2
2000	0.290	107.0	1.558	32.3	0.380	45.0	0.256	-99.4

$V_{CE}=2V, I_C=30mA, Z_O=50\Omega$

Freq(MHz)	S11	$\angle S11$	S21	$\angle S21$	S12	$\angle S12$	S22	$\angle S22$
100	0.370	-97.4	22.555	117.0	0.031	65.1	0.518	-49.0
200	0.288	-135.1	12.614	99.9	0.051	67.4	0.326	-55.8
400	0.260	-168.5	6.590	85.5	0.090	69.9	0.229	-58.1
600	0.259	174.8	4.499	76.4	0.131	68.6	0.207	-62.3
800	0.263	159.3	3.419	68.1	0.172	66.0	0.204	-68.3
1000	0.262	148.2	2.796	61.7	0.211	62.8	0.206	-73.2
1200	0.275	138.9	2.382	54.7	0.248	59.1	0.215	-79.6
1400	0.279	130.4	2.089	48.8	0.284	55.6	0.220	-85.4
1600	0.286	122.5	1.869	43.0	0.320	52.1	0.227	-91.1
1800	0.291	113.8	1.700	37.3	0.353	48.4	0.235	-97.0
2000	0.293	105.4	1.562	32.2	0.387	44.7	0.242	-102.2

2SC5415A

S Parameters (Common emitter)

$V_{CE}=5V, I_C=5mA, Z_O=50\Omega$

Freq(MHz)	S11	$\angle S11$	S21	$\angle S21$	S12	$\angle S12$	S22	$\angle S22$
100	0.752	-45.7	12.674	144.1	0.037	67.6	0.871	-21.6
200	0.575	-78.6	9.416	121.5	0.058	57.3	0.697	-32.2
400	0.391	-119.9	5.688	97.7	0.082	54.4	0.532	-38.3
600	0.334	-146.4	4.015	84.3	0.103	56.8	0.472	-41.5
800	0.307	-169.1	3.085	73.2	0.126	58.9	0.450	-45.4
1000	0.292	174.7	2.534	65.1	0.151	60.2	0.444	-49.5
1200	0.303	160.6	2.164	56.8	0.177	60.0	0.449	-54.6
1400	0.305	148.6	1.896	499.9	0.204	59.7	0.453	-59.6
1600	0.314	137.9	1.693	43.2	0.235	58.9	0.454	-65.0
1800	0.321	127.3	1.530	36.9	0.267	57.1	0.460	-70.0
2000	0.328	117.7	1.394	31.5	0.299	55.1	0.470	-76.4

$V_{CE}=5V, I_C=10mA, Z_O=50\Omega$

Freq(MHz)	S11	$\angle S11$	S21	$\angle S21$	S12	$\angle S12$	S22	$\angle S22$
100	0.601	-58.4	18.468	133.9	0.033	65.7	0.765	-25.1
200	0.413	-92.4	12.043	112.1	0.049	61.0	0.603	-30.7
400	0.275	-132.7	6.703	92.4	0.078	63.3	0.509	-36.8
600	0.240	-157.9	4.641	81.3	0.107	64.8	0.470	-45.9
800	0.228	-179.9	3.536	71.9	0.137	64.6	0.438	-56.8
1000	0.221	164.7	2.889	64.8	0.168	63.6	0.408	-69.3
1200	0.232	151.6	2.462	57.2	0.199	61.5	0.371	-83.9
1400	0.238	140.6	2.154	51.0	0.229	59.5	0.334	-100.6
1600	0.249	131.1	1.924	44.8	0.259	57.3	0.298	-120.1
1800	0.257	120.9	1.740	38.8	0.290	54.6	0.265	-143.5
2000	0.262	111.5	1.589	33.6	0.322	51.6	0.246	-170.6

$V_{CE}=5V, I_C=30mA, Z_O=50\Omega$

Freq(MHz)	S11	$\angle S11$	S21	$\angle S21$	S12	$\angle S12$	S22	$\angle S22$
100	0.373	-79.4	24.799	120.4	0.026	67.6	0.598	-36.8
200	0.245	-114.8	14.190	102.5	0.043	69.5	0.418	-39.2
400	0.183	-154.3	7.472	87.6	0.077	71.8	0.331	-38.5
600	0.174	-175.8	5.102	78.5	0.112	70.9	0.310	-41.3
800	0.177	163.8	3.872	70.4	0.147	68.7	0.305	-46.3
1000	0.177	150.2	3.158	64.1	0.181	66.1	0.308	-51.0
1200	0.190	139.3	2.681	57.4	0.215	62.8	0.313	-57.0
1400	0.197	129.5	2.343	51.6	0.247	59.6	0.317	-62.4
1600	0.209	121.2	2.090	45.9	0.279	56.7	0.321	-67.8
1800	0.217	111.6	1.892	40.3	0.309	53.3	0.327	-73.6
2000	0.222	102.6	1.727	35.2	0.340	49.9	0.333	-78.9

$V_{CE}=5V, I_C=50mA, Z_O=50\Omega$

Freq(MHz)	S11	$\angle S11$	S21	$\angle S21$	S12	$\angle S12$	S22	$\angle S22$
100	0.308	-92.8	25.470	116.0	0.024	69.2	0.543	-36.8
200	0.221	-129.7	14.126	99.7	0.041	72.1	0.389	-36.4
400	0.190	-165.7	7.357	85.9	0.076	73.8	0.324	-35.3
600	0.189	176.0	5.012	77.4	0.111	72.5	0.309	-38.8
800	0.195	158.6	3.800	69.4	0.146	69.9	0.307	-44.2
1000	0.195	146.5	3.097	63.2	0.180	67.2	0.311	-49.3
1200	0.209	136.8	2.630	56.5	0.214	63.7	0.317	-55.6
1400	0.216	127.8	2.300	50.8	0.246	60.5	0.321	-61.3
1600	0.227	119.9	2.050	45.1	0.279	57.5	0.325	-66.9
1800	0.237	111.0	1.857	39.4	0.310	54.1	0.331	-72.8
2000	0.241	102.2	1.695	34.5	0.341	50.5	0.337	-78.3

2SC5415A

Embossed Taping Specification

2SC5415AE-TD-E, 2SC5415AF-TD-E

1. Packing Format

Package Name	Carrier Tape Type	Maximum Number of devices contained (pcs)			Packing format	
		Reel	Inner box	Outer box	Inner BOX (C-1)	Outer BOX (A-7)
PCP	PCP	1,000	4,000	24,000	4 reels contained Dimensions:mm (external) 183×72×185	6 inner boxes contained Dimensions:mm (external) 440×195×210

Reel label, Inner box label
(unit : mm)

Outer box label
It is a label at the time of factory shipments.
The form of a label may change in physical distribution process.

Packing method

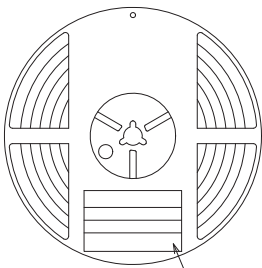

Type No.
LOT No.
Quantity
Origin

Reel label

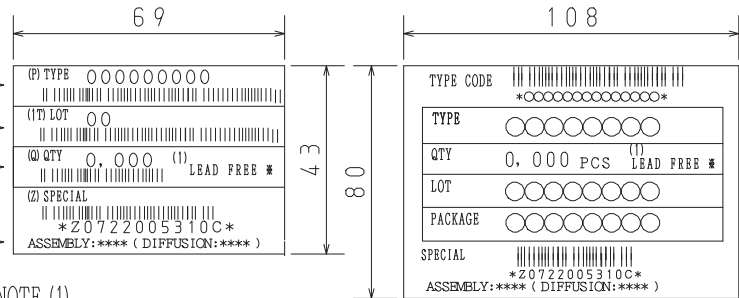

NOTE (1)

The LEAD FREE * description shows that the surface treatment of the terminal is lead free.

Label	JEITA Phase
LEAD FREE 3	JEITA Phase 3A
LEAD FREE 4	JEITA Phase 3

2. Taping configuration

2-1. Carrier tape size (unit:mm)

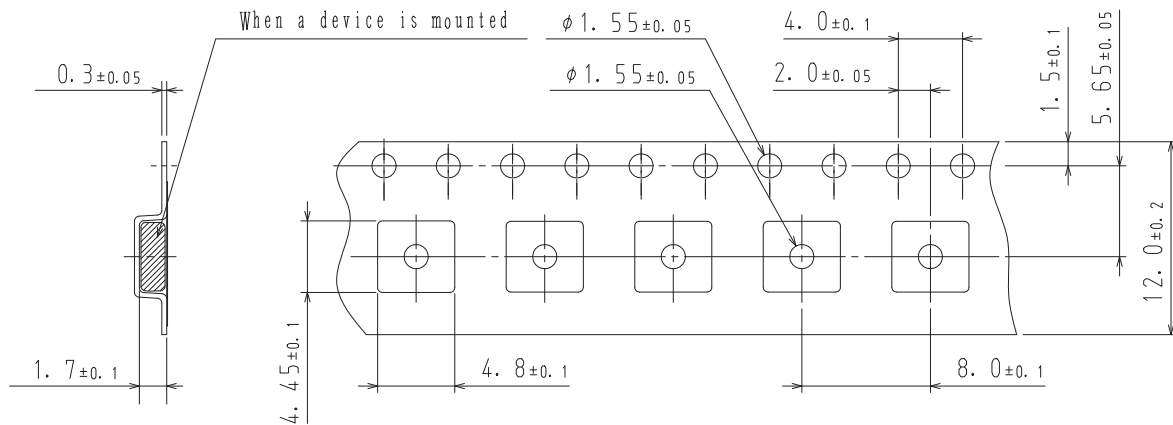

2-2. Device placement direction

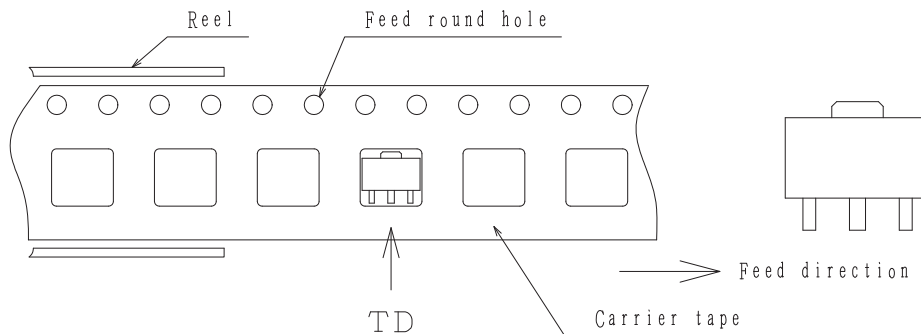

Those with pin 1 index on the feed hole side.....TD

2SC5415A

Outline Drawing

2SC5415AE-TD-E, 2SC5415AF-TD-E

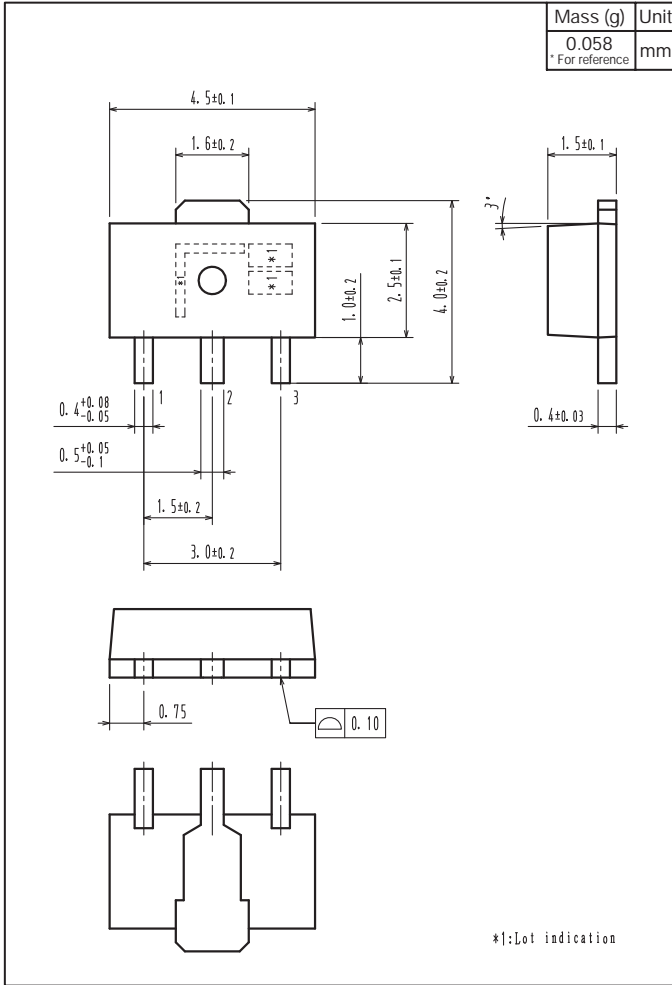

Land Pattern Example

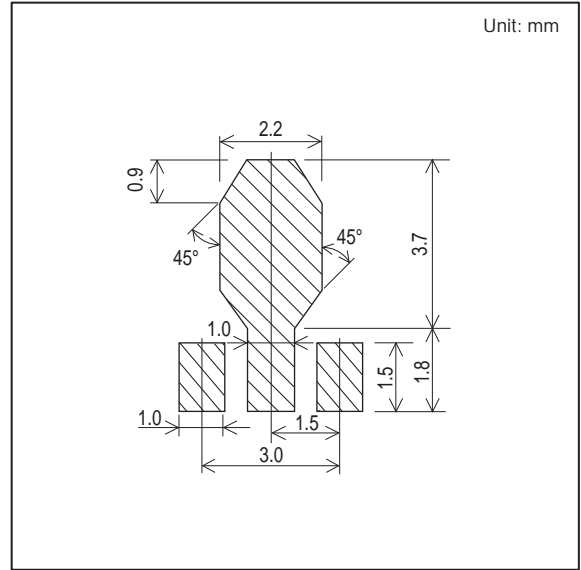

- Any and all SANYO Semiconductor Co.,Ltd. products described or contained herein are, with regard to "standard application", intended for the use as general electronics equipment. The products mentioned herein shall not be intended for use for any "special application" (medical equipment whose purpose is to sustain life, aerospace instrument, nuclear control device, burning appliances, transportation machine, traffic signal system, safety equipment etc.) that shall require extremely high level of reliability and can directly threaten human lives in case of failure or malfunction of the product or may cause harm to human bodies, nor shall they grant any guarantee thereof. If you should intend to use our products for new introduction or other application different from current conditions on the usage of automotive device, communication device, office equipment, industrial equipment etc. , please consult with us about usage condition (temperature, operation time etc.) prior to the intended use. If there is no consultation or inquiry before the intended use, our customer shall be solely responsible for the use.
- Specifications of any and all SANYO Semiconductor Co.,Ltd. products described or contained herein stipulate the performance, characteristics, and functions of the described products in the independent state, and are not guarantees of the performance, characteristics, and functions of the described products as mounted in the customer's products or equipment. To verify symptoms and states that cannot be evaluated in an independent device, the customer should always evaluate and test devices mounted in the customer's products or equipment.
- SANYO Semiconductor Co.,Ltd. assumes no responsibility for equipment failures that result from using products at values that exceed, even momentarily, rated values (such as maximum ratings, operating condition ranges, or other parameters) listed in products specifications of any and all SANYO Semiconductor Co.,Ltd. products described or contained herein.
- Regarding monolithic semiconductors, if you should intend to use this IC continuously under high temperature, high current, high voltage, or drastic temperature change, even if it is used within the range of absolute maximum ratings or operating conditions, there is a possibility of decrease reliability. Please contact us for a confirmation.
- SANYO Semiconductor Co.,Ltd. strives to supply high-quality high-reliability products, however, any and all semiconductor products fail or malfunction with some probability. It is possible that these probabilistic failures or malfunction could give rise to accidents or events that could endanger human lives, trouble that could give rise to smoke or fire, or accidents that could cause damage to other property. When designing equipment, adopt safety measures so that these kinds of accidents or events cannot occur. Such measures include but are not limited to protective circuits and error prevention circuits for safe design, redundant design, and structural design.
- In the event that any or all SANYO Semiconductor Co.,Ltd. products described or contained herein are controlled under any of applicable local export control laws and regulations, such products may require the export license from the authorities concerned in accordance with the above law.
- No part of this publication may be reproduced or transmitted in any form or by any means, electronic or mechanical, including photocopying and recording, or any information storage or retrieval system, or otherwise, without the prior written consent of SANYO Semiconductor Co.,Ltd.
- Any and all information described or contained herein are subject to change without notice due to product/technology improvement, etc. When designing equipment, refer to the "Delivery Specification" for the SANYO Semiconductor Co.,Ltd. product that you intend to use.
- Upon using the technical information or products described herein, neither warranty nor license shall be granted with regard to intellectual property rights or any other rights of SANYO Semiconductor Co.,Ltd. or any third party. SANYO Semiconductor Co.,Ltd. shall not be liable for any claim or suits with regard to a third party's intellectual property rights which has resulted from the use of the technical information and products mentioned above.

This catalog provides information as of September, 2012. Specifications and information herein are subject to change without notice.



Компания «ЭлектроПласт» предлагает заключение долгосрочных отношений при поставках импортных электронных компонентов на взаимовыгодных условиях!

Наши преимущества:

- Оперативные поставки широкого спектра электронных компонентов отечественного и импортного производства напрямую от производителей и с крупнейших мировых складов;
- Поставка более 17-ти миллионов наименований электронных компонентов;
- Поставка сложных, дефицитных, либо снятых с производства позиций;
- Оперативные сроки поставки под заказ (от 5 рабочих дней);
- Экспресс доставка в любую точку России;
- Техническая поддержка проекта, помощь в подборе аналогов, поставка прототипов;
- Система менеджмента качества сертифицирована по Международному стандарту ISO 9001;
- Лицензия ФСБ на осуществление работ с использованием сведений, составляющих государственную тайну;
- Поставка специализированных компонентов (Xilinx, Altera, Analog Devices, Intersil, Interpoint, Microsemi, Aeroflex, Peregrine, Syfer, Eurofarad, Texas Instrument, Miteq, Cobham, E2V, MA-COM, Hittite, Mini-Circuits, General Dynamics и др.);

Помимо этого, одним из направлений компании «ЭлектроПласт» является направление «Источники питания». Мы предлагаем Вам помощь Конструкторского отдела:

- Подбор оптимального решения, техническое обоснование при выборе компонента;
- Подбор аналогов;
- Консультации по применению компонента;
- Поставка образцов и прототипов;
- Техническая поддержка проекта;
- Защита от снятия компонента с производства.



Как с нами связаться

Телефон: 8 (812) 309 58 32 (многоканальный)

Факс: 8 (812) 320-02-42

Электронная почта: org@eplast1.ru

Адрес: 198099, г. Санкт-Петербург, ул. Калинина, дом 2, корпус 4, литера А.