

SMT POWER INDUCTORS

Shielded Drum Core

PF0552NL and PF0553NL Series



- 🔌 Single, coupled or (1:1) transformer applications
- 🔌 **Footprint:** PF0552NL - 12.5mm x 12.5mm x 6mm Max
PF0553NL - 12.5mm x 12.5mm x 8mm Max
- 🔌 **Current Rating:** up to 17.72A
- 🔌 **Inductance Range:** 0.47μH to 4mH
- 🔌 260°C reflow peak temperature qualified
- 🔌 200Vac isolation between windings

Electrical Specifications @ 25°C — Operating Temperature -40°C to +125°C ⁶

Part ^{2,3} Number	Inductance* @ 0A _{DC} (μH ±20%)	Inductance @ I _{rated} (μH TYP)	I _{rated} ⁵ (A)	DCR (mΩ MAX)	Saturation ⁶ Current I _{SAT} -30% (A)	Heating ⁷ Current I _{DC} +40°C (A)	Core Loss ⁸ Factor (K2)	Connection** Mode
PF0552.471NL	0.49	0.49	14.2	1.6	33	14.2	100	Parallel
PF0552.102NL	0.91	0.91	12.9	2.4	24	12.9	140	Parallel
PF0552.152NL	1.5	1.5	12.4	2.9	18.4	12.4	180	Parallel
PF0552.471NL	2.0	2.0	7.1	6.4	16.4	7.1	210	Series
PF0552.222NL	2.2	2.2	11.1	3.9	15	11.1	210	Parallel
PF0552.332NL	3.1	3.1	10.1	5.8	12.8	10.1	250	Parallel
PF0552.102NL	3.6	3.6	6.5	9.6	11.8	6.5	270	Series
PF0552.472NL	5.3	4.7	8.5	9.2	9.8	8.5	330	Parallel
PF0552.152NL	5.9	5.9	6.2	12	9.2	6.2	350	Series
PF0552.682NL	6.6	6.6	7.3	12	8.8	7.3	370	Parallel
PF0552.822NL	8.1	8.1	6.5	18	7.8	6.5	410	Parallel
PF0552.222NL	8.8	8.8	5.6	16	7.5	5.6	430	Series
PF0552.103NL	9.7	9.7	6.0	19	7.2	6.0	450	Parallel
PF0552.332NL	12	12	5.0	23	6.4	5.0	490	Series
PF0552.153NL	15	15	5.5	24	5.8	5.5	550	Parallel
PF0552.472NL	21	19	4.3	37	4.9	4.3	660	Series
PF0552.223NL	22	22	4.6	35	4.8	4.6	670	Parallel
PF0552.682NL	27	27	3.7	48	4.4	3.7	760	Series
PF0552.822NL	32	32	3.3	66	3.9	3.3	810	Series
PF0552.333NL	34	33	3.7	54	3.9	3.7	840	Parallel
PF0552.103NL	39	39	3.0	73	3.6	3.0	900	Series
PF0552.473NL	47	47	3.2	69	3.2	3.3	980	Parallel
PF0552.153NL	61	60	2.8	97	2.9	2.8	1100	Series
PF0552.683NL	68	68	2.7	100	2.7	2.8	1200	Parallel
PF0552.823NL	84	82	2.4	130	2.4	2.4	1300	Parallel
PF0552.223NL	89	88	2.3	140	2.4	2.3	1400	Series
PF0552.104NL	100	100	2.2	160	2.2	2.3	1400	Parallel
PF0552.333NL	135	130	1.9	220	2.0	1.9	1700	Series
PF0552.154NL	150	150	1.8	230	1.8	1.8	1800	Parallel
PF0552.473NL	190	190	1.7	270	1.6	1.7	2000	Series
PF0552.224NL	220	220	1.4	350	1.5	1.4	2100	Parallel
PF0552.683NL	270	270	1.4	400	1.4	1.4	2400	Series
PF0552.823NL	330	330	1.2	530	1.2	1.2	2600	Series
PF0552.334NL	340	330	1.2	470	1.2	1.2	2700	Parallel
PF0552.104NL	410	400	1.1	640	1.1	1.1	2900	Series
PF0552.474NL	470	470	1.0	690	1.0	1.0	3100	Parallel
PF0552.154NL	600	600	0.88	930	0.91	0.88	3500	Series
PF0552.684NL	680	680	0.81	1000	0.86	0.81	3700	Parallel
PF0552.824NL	830	830	0.69	1400	0.78	0.69	4100	Parallel
PF0552.224NL	870	870	0.71	1400	0.76	0.71	4200	Series
PF0552.105NL	1000	1000	0.65	1600	0.70	0.65	4500	Parallel
PF0552.334NL	1300	1300	0.61	1900	0.62	0.61	5100	Series
PF0552.474NL	1900	1900	0.51	2700	0.51	0.51	6300	Series
PF0552.684NL	2700	2700	0.4	4100	0.43	0.4	7400	Series
PF0552.824NL	3300	3300	0.34	5500	0.39	0.34	8200	Series
PF0552.105NL	4000	4000	0.32	6400	0.35	0.32	9100	Series

NOTES FROM TABLE: (See page 43)

USA 858 674 8100 • Germany 49 7032 7806 0 • Singapore 65 6287 8998 • Shanghai 86 21 54643211 / 2 • China 86 755 33966678 • Taiwan 886 3 4641811

SMT POWER INDUCTORS

Shielded Drum Core

PF0552NL and PF0553NL Series



Electrical Specifications @ 25°C — Operating Temperature -40°C to +125°C⁶

Part ^{2,3} Number	Inductance* @ 0Adc ($\mu\text{H} \pm 20\%$)	Inductance @ Irated ($\mu\text{H TYP}$)	Irated ⁵ (A)	DCR (m Ω MAX)	Saturation ⁶ Current ISAT -30% (A)	Heating ⁷ Current Idc +40°C(A)	Core Loss ⁸ Factor (K2)	Connection** Mode
PF0553.471NL	0.43	0.43	17	1.6	56	17	53	Parallel
PF0553.102NL	0.86	0.86	15	2.4	40	15	76	Parallel
PF0553.152NL	1.4	1.4	13	2.9	31	13	97	Parallel
PF0553.471NL	1.7	1.7	9.0	6.4	28	9.0	110	Series
PF0553.222NL	2.0	2.0	13	3.7	25	13	110	Parallel
PF0553.332NL	2.8	2.8	10	5.4	21	10	130	Parallel
PF0553.102NL	3.4	3.4	7.7	9.4	20	7.7	150	Series
PF0553.472NL	4.8	4.7	8.1	9.2	16	8.1	180	Parallel
PF0553.152NL	5.4	5.4	6.7	12	16	6.7	190	Series
PF0553.682NL	7.4	6.8	7.2	12	13	7.2	220	Parallel
PF0553.222NL	8.1	8.1	6.2	15	13	6.2	230	Series
PF0553.822NL	8.9	8.2	6.2	15	12	6.2	240	Parallel
PF0553.103NL	10.5	10	6.0	17	11	6.0	260	Parallel
PF0553.332NL	11.3	11.3	5.2	22	11	5.2	270	Series
PF0553.153NL	14	15	5.0	24	9.6	5.0	300	Parallel
PF0553.472NL	19	19	4.1	37	8.2	4.1	350	Series
PF0553.223NL	23	22	3.9	39	7.6	3.9	390	Parallel
PF0553.682NL	30	27	3.6	46	6.6	3.6	440	Series
PF0553.333NL	34	33	3.2	59	6.2	3.2	470	Parallel
PF0553.822NL	35	33	3.1	62	6.1	3.1	470	Series
PF0553.103NL	42	40	3.0	67	5.6	3.0	520	Series
PF0553.473NL	47	47	2.9	72	5.3	2.9	550	Parallel
PF0553.153NL	56	56	2.5	96	4.8	2.5	600	Series
PF0553.683NL	66	66	2.4	110	4.4	2.4	650	Parallel
PF0553.823NL	80	80	2.0	140	4.1	2.0	720	Parallel
PF0553.223NL	92	88	2.0	160	3.8	2.0	770	Series
PF0553.104NL	100	100	1.9	160	3.6	1.9	810	Parallel
PF0553.333NL	135	130	1.6	240	3.1	1.6	930	Series
PF0553.154NL	150	150	1.6	250	3.0	1.6	1000	Parallel
PF0553.473NL	190	190	1.5	290	2.6	1.5	1100	Series
PF0553.224NL	220	220	1.3	380	2.4	1.3	1200	Parallel
PF0553.683NL	270	270	1.2	420	2.2	1.2	1300	Series
PF0553.823NL	320	320	1.0	570	2.0	1.0	1400	Series
PF0553.334NL	330	330	1.0	570	2.0	1.0	1500	Parallel
PF0553.104NL	400	400	0.97	650	1.8	0.97	1600	Series
PF0553.474NL	470	470	0.83	860	1.7	0.83	1700	Parallel
PF0553.154NL	600	600	0.78	990	1.5	0.78	2000	Series
PF0553.684NL	680	680	0.75	1100	1.4	0.75	2100	Parallel
PF0553.824NL	830	820	0.64	1400	1.3	0.64	2300	Parallel
PF0553.224NL	890	880	0.63	1500	1.2	0.63	2400	Series
PF0553.105NL	1000	1000	0.61	1600	1.1	0.61	2500	Parallel
PF0553.334NL	1300	1300	0.51	2300	1.0	0.51	2900	Series
PF0553.474NL	1900	1900	0.42	3400	0.84	0.42	3500	Series
PF0553.684NL	2700	2700	0.38	4300	0.69	0.38	4200	Series
PF0553.824NL	3300	3300	0.32	5800	0.63	0.32	4600	Series
PF0553.105NL	4000	4000	0.31	6500	0.57	0.31	5100	Series

NOTES FROM TABLE: (See page 43)

*Open circuit inductance test parameters: Inductance values up to 100 μH : 100kHz - 0.10Vac with 0Adc bias;
Inductance values higher than 100 μH : 20kHz - 0.10Vac with 0Adc bias.

**Parallel connection mode (1,2 - 3,4); Serial connection mode (1-4) with (2-3) short circuited.

SMT POWER INDUCTORS

Shielded Drum Core

PF0552NL and PF0553NL Series



Mechanical

Schematics

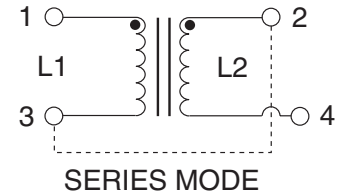
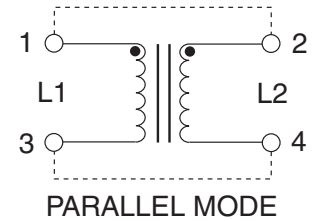
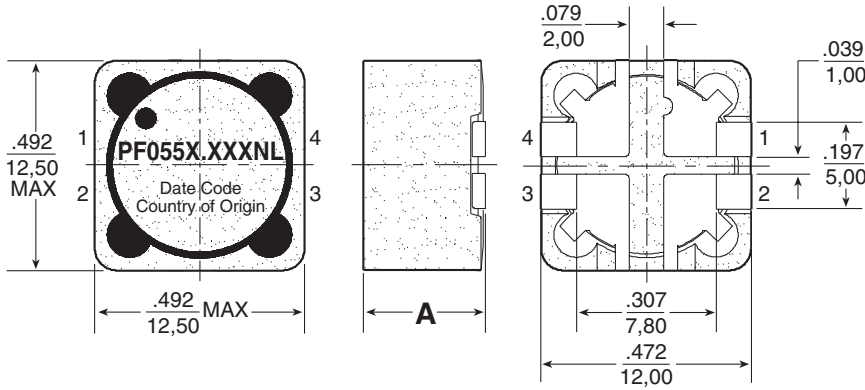

SUGGESTED PAD LAYOUTS

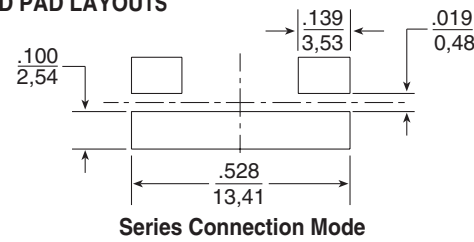
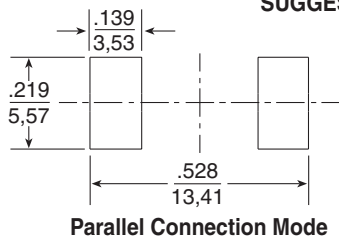

	PF0552NL	PF0553NL
Weight	3.2 grams	4.5 grams
Tape & Reel	500/reel	400/reel
"A" (height - in./mm)	0.236/6,00 MAX	0.315/8,00 MAX
"B" (height - in./mm)	0.246/6,25	0.343/8,70

Dimensions: Inches
mm
Unless otherwise specified,
all tolerances are \pm .004
0,10

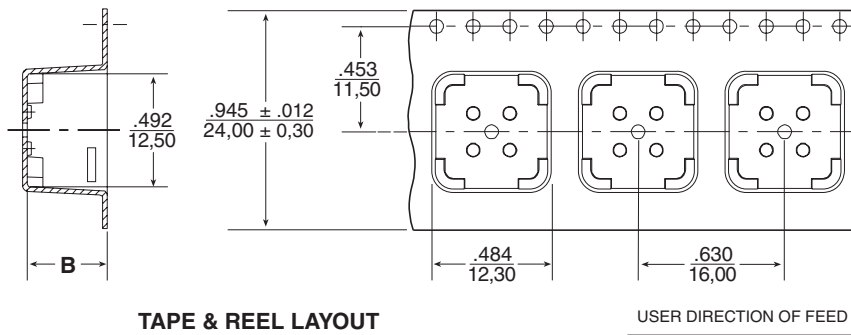

SMT POWER INDUCTORS

Shielded Drum Core Series



Notes from Tables (pages 27 - 42)

1. Unless otherwise specified, all testing is made at 100kHz, 0.1VAC.
2. Optional Tape & Reel packaging can be ordered by adding a "T" suffix to the part number (i.e. P1166.102NL becomes P1166.102NLT). Pulse complies with industry standard Tape and Tape & Reel specification EIA481.
3. The "NL" suffix indicates an RoHS-compliant part number. Non-NL suffixed parts are not necessarily RoHS compliant, but are electrically and mechanically equivalent to NL versions. If a part number does not have the "NL" suffix, but an RoHS compliant version is required, please contact Pulse for availability.
4. Temperature of the component (ambient plus temperature rise) must be within specified operating temperature range.
5. The rated current (I_{rated}) as listed is either the saturation current or the heating current depending on which value is lower.
6. The saturation current, I_{sat}, is the current at which the component inductance drops by the indicated percentage (typical) at an ambient temperature of 25°C. This current is determined by placing the component in the specified ambient environment and applying a short duration pulse current (to eliminate self-heating effects) to the component.
7. The heating current, I_{dc}, is the DC current required to raise the component temperature by the indicated delta (approximately). The heating current is determined by mounting the component on a typical PCB and applying current for 30 minutes. The temperature is measured by placing the thermocouple on top of the unit under test.

8. In high volt*time (Et) or ripple current applications, additional heating in the component can occur due to core losses in the inductor which may necessitate derating the current in order to limit the temperature rise of the component. In order to determine the approximate total loss (or temperature rise) for a given application, both copper losses and core losses should be taken into account.

Estimated Temperature Rise:

$$\text{Trise} = [\text{Total loss (mW)} / K0]^{.833} (\text{°C})$$

$$\text{Total loss} = \text{Copper loss} + \text{Core loss (mW)}$$

$$\text{Copper loss} = I_{\text{RMS}}^2 \times \text{DCR (Typical)} \text{ (mW)}$$

$$I_{\text{rms}} = [I_{\text{DC}}^2 + \Delta I^2/12]^{1/2} \text{ (A)}$$

$$\text{Core loss} = K1 \times f \text{ (kHz)}^{1.23} \times \text{Bac(Ga)}^{2.38} \text{ (mW)}$$

$$\text{Bac (peak to peak flux density)} = K2 \times \Delta I \text{ (Ga)}$$

$$[= K2/L(\mu\text{H}) \times \text{Et(V}\cdot\mu\text{Sec)} \text{ (Ga)}]$$

where f varies between 25kHz and 1MHz, and Bac is less than 2500 Gauss.

K2 is a core size and winding dependant value and is given for each p/n in the proceeding datasheets. K0 & K1 are platform and material dependant constants and are given in the table below for each platform.

Part No.	Trise Factor (K0)	Core Loss Factor (K1)
PG0085	2.3	5.29E-10
PG0087	5.8	15.2E-10
PG0040/41	0.8	2.80E-10
P1174	0.8	6.47E-10
PF0601	4.6	14.0E-10
PF0464	3.6	24.7E-10
PF0465	3.6	33.4E-10
P1166	1.9	29.6E-10
P1167	2.1	42.2E-10
PF0560NL	5.5	136E-10
P1168/69	4.8	184E-10
P1170/71	4.3	201E-10
P1172/73	5.6	411E-10
PF0552NL	8.3	201E-10
PF0553NL	7.1	411E-10

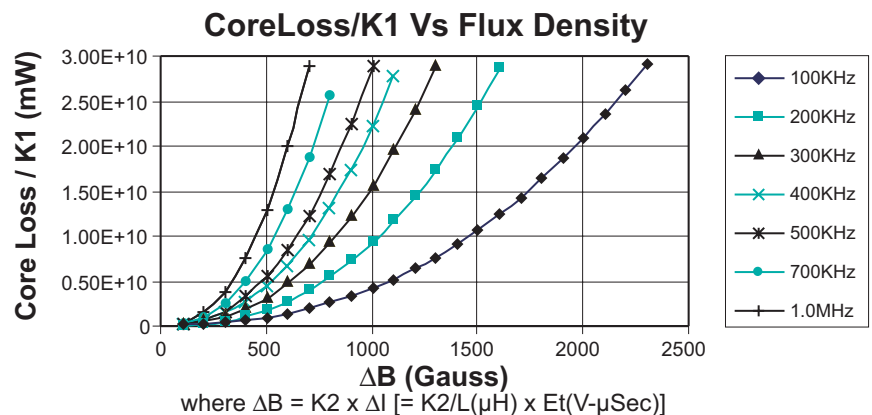

Take note that the component's temperature rise varies depending on the system condition. It is suggested that the component be tested at the system level, to verify the temperature rise of the component during system operation.



Компания «ЭлектроПласт» предлагает заключение долгосрочных отношений при поставках импортных электронных компонентов на взаимовыгодных условиях!

Наши преимущества:

- Оперативные поставки широкого спектра электронных компонентов отечественного и импортного производства напрямую от производителей и с крупнейших мировых складов;
- Поставка более 17-ти миллионов наименований электронных компонентов;
- Поставка сложных, дефицитных, либо снятых с производства позиций;
- Оперативные сроки поставки под заказ (от 5 рабочих дней);
- Экспресс доставка в любую точку России;
- Техническая поддержка проекта, помощь в подборе аналогов, поставка прототипов;
- Система менеджмента качества сертифицирована по Международному стандарту ISO 9001;
- Лицензия ФСБ на осуществление работ с использованием сведений, составляющих государственную тайну;
- Поставка специализированных компонентов (Xilinx, Altera, Analog Devices, Intersil, Interpoint, Microsemi, Aeroflex, Peregrine, Syfer, Eurofarad, Texas Instrument, Miteq, Cobham, E2V, MA-COM, Hittite, Mini-Circuits, General Dynamics и др.);

Помимо этого, одним из направлений компании «ЭлектроПласт» является направление «Источники питания». Мы предлагаем Вам помощь Конструкторского отдела:

- Подбор оптимального решения, техническое обоснование при выборе компонента;
- Подбор аналогов;
- Консультации по применению компонента;
- Поставка образцов и прототипов;
- Техническая поддержка проекта;
- Защита от снятия компонента с производства.



Как с нами связаться

Телефон: 8 (812) 309 58 32 (многоканальный)

Факс: 8 (812) 320-02-42

Электронная почта: org@eplast1.ru

Адрес: 198099, г. Санкт-Петербург, ул. Калинина, дом 2, корпус 4, литера А.