



## **Ceramic transient voltage suppressors**

Leaded transient voltage/RFI suppressors (SHCVs)

**Series/Type:**

Date: August 2008

**Leaded transient voltage/RFI suppressors (SHCVs)**

**SHCV series**

**EPCOS type designation system for leaded transient voltage / RFI suppressors**

SR	1	S	14	B	M	474	X	G
<b>SR</b> $\triangleq$ Leaded, SHCV series								
<b>EIA case sizes of used chips:</b> 6 $\triangleq$ 12 x 06 / 3.2 x 1.6 mm 1 $\triangleq$ 18 x 12 / 4.5 x 3.2 mm 2 $\triangleq$ 22 x 20 / 5.7 x 5.0 mm								
<b>Varistor voltage tolerance:</b> K $\triangleq$ $\pm 10\%$ S $\triangleq$ Special tolerance								
<b>Maximum RMS operating voltage (<math>V_{RMS}</math>):</b> 14 $\triangleq$ 14 V								
<b>Special varistor voltage tolerance:</b> B $\triangleq$ Special tolerance								
<b>Capacitance tolerance:</b> M $\triangleq$ $\pm 20\%$								
<b>Capacitance value:</b> 474 $\triangleq$ $47 \cdot 10^4$ pF $\triangleq$ 0.47 $\mu$ F								
<b>Capacitor ceramic:</b> X $\triangleq$ X7R								
<b>Taping mode:</b> G $\triangleq$ Taped version - $\triangleq$ Bulk								

**Leaded transient voltage/RFI suppressors (SHCVs)**
**SHCV series**
**Features**

- RFI noise suppression and transient overvoltage protection integrated in a single component
- Reliable protection against automotive transients such as load dump and jump start (for SR1 and SR2 types)
- High capacitance (up to 4.7  $\mu$ F)
- Low clamping voltage
- RoHS-compatible
- Suitable for lead-free soldering
- PSpice simulation models available

**Applications**

- RFI noise suppression and transient overvoltage protection on DC lines of small motors, windscreen wipers, window lifters, mirrors, central locking, memory seat, sunroof

**Design**

- Combination of multilayer RF filter capacitor and multilayer varistor
- Coating: flame-retardant to UL 94 V0, epoxy resin
- Terminals: tinned iron wire, RoHS-compatible

**V/I characteristics and derating curves**

V/I and derating curves are attached to the data sheet. The curves are sorted by  $V_{RMS}$  and then by case size, which is included in the type designation.

**General technical data**

Maximum RMS operating voltage		$V_{RMS,max}$	14 ... 35	V
Maximum DC operating voltage		$V_{DC,max}$	16 ... 45	V
Maximum surge current	(8/20 $\mu$ s)	$I_{surge,max}$	100 ... 1200	A
Maximum load dump energy	(10 pulses)	$W_{LD}$	1.5 ... 12	J
Maximum jump start voltage	(5 min)	$V_{jump}$	24.5 ... 26	V
Maximum clamping voltage	(8/20 $\mu$ s)	$V_{clamp,max}$	38 ... 90	V
Nominal capacitance	(1 kHz, 0.5 V)	$C_{nom}$	220 ... 4700	nF
Insulation resistance		$R_{ins}$	$\geq 10$	M $\Omega$
Response time		$t_{resp}$	< 25	ns
Operating temperature		$T_{op}$	-55/+125	$^{\circ}$ C
Storage temperature		$T_{stg}$	-55/+150	$^{\circ}$ C

### Temperature derating

Climatic category:  $-55/+125\text{ }^{\circ}\text{C}$

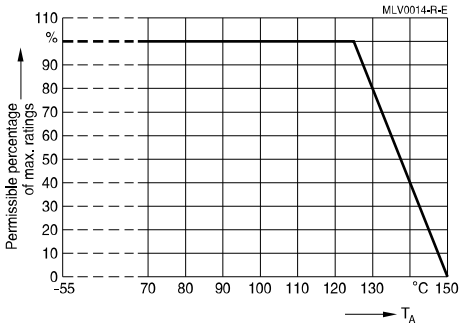

**Leaded transient voltage/RFI suppressors (SHCVs)**
**SHCV series**
**Electrical specifications and ordering codes**
**Maximum ratings ( $T_{op,max} = 125\text{ }^{\circ}\text{C}$ )**

Type	Ordering code	$V_{RMS,max}$	$V_{DC,max}$	$I_{surge,max}$ (8/20 $\mu\text{s}$ )	$W_{max}$ (2 ms)	$W_{LD}$ (10 pulses)	$P_{diss,max}$
		V	V	A	mJ	J	mW
SR1S14BM105X	B72587G3140S200	14	16	800	2400	6	15
SR1S14BM155X	B72587H3140S200	14	16	800	2400	6	15
SR1S14BM474X	B72587E3140S200	14	16	800	2400	6	15
SR2S14BM155X	B72547H3140S200	14	16	1200	5800	12	30
SR2S14BM474X	B72547E3140S200	14	16	1200	5800	12	30
SR2S14BM475X	B72547L3140S200	14	16	1200	5800	12	30
SR6K14M224X	B72527C3140K000	14	18	200	500	1.5	8
SR1K20M105X	B72587G3200K000	20	26	800	3000	6	15
SR1K20M155X	B72587H3200K000	20	26	800	3000	6	15
SR1K20M225X	B72587J3200K000	20	26	800	3000	6	15
SR1K20M474X	B72587E3200K000	20	26	800	3000	6	15
SR2K20M105X	B72547G3200K000	20	26	1200	7800	12	30
SR2K20M474X	B72547E3200K000	20	26	1200	7800	12	30
SR6K20M105X	B72527G3200K000	20	26	200	700	1.5	8
SR6K35M105X	B72527G3350K000	35	45	100	400	1.5	8
SR6K35M474X	B72527E3350K000	35	45	100	400	1.5	8

**Characteristics ( $T_A = 25\text{ }^{\circ}\text{C}$ )**

Type	$V_V$ (1 mA)V	$\Delta V_V$ %	$V_{jump}$ (5 min) V	$V_{clamp,max}$ V	$I_{clamp}$ (8/20 $\mu\text{s}$ ) A	$C_{nom}$ (1 kHz, 0.5 V) nF	$\Delta C_{nom}$ %
SR1S14BM105X	22	+23/-0	24.5	40	5	1000	$\pm 20$
SR1S14BM155X	22	+23/-0	24.5	40	5	1500	$\pm 20$
SR1S14BM474X	22	+23/-0	24.5	40	5	470	$\pm 20$
SR2S14BM155X	22	+23/-0	24,5	40	10	1500	$\pm 20$
SR2S14BM474X	22	+23/-0	24,5	40	10	470	$\pm 20$
SR2S14BM475X	22	+23/-0	24,5	40	10	4700	$\pm 20$
SR6K14M224X	22	$\pm 10$	-	38	1	220	$\pm 20$
SR1K20M105X	33	$\pm 10$	26	58	5	1000	$\pm 20$
SR1K20M155X	33	$\pm 10$	26	58	5	1500	$\pm 20$
SR1K20M225X	33	$\pm 10$	26	58	5	2200	$\pm 20$
SR1K20M474X	33	$\pm 10$	26	58	5	470	$\pm 20$
SR2K20M105X	33	$\pm 10$	26	58	10	1000	$\pm 20$
SR2K20M474X	33	$\pm 10$	26	58	10	470	$\pm 20$
SR6K20M105X	33	$\pm 10$	-	54	1	1000	$\pm 20$
SR6K35M105X	56	$\pm 10$	-	90	1	1000	$\pm 20$
SR6K35M474X	56	$\pm 10$	-	90	1	470	$\pm 20$

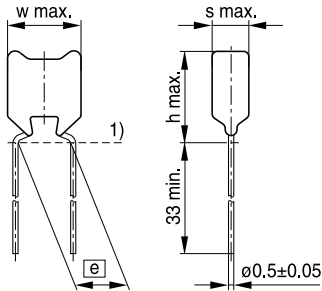
**Leaded transient voltage/RFI suppressors (SHCVs)**
**SHCV series**
**Dimensional drawing**

$$[e] = 5.0 \pm 1$$

 Offset =  $0.0 \pm 1$ 

1) Seating plane to IEC 60717

VAR0394-B

Dimensions in mm

Type	$w_{\max}$	$h_{\max}$	$s_{\max}$
SHCV			
SR1 ... 474X	7.3	7.8	3.7
SR1 ... 105X	7.3	7.8	3.7
SR1 ... 155X	7.3	7.8	3.7
SR1 ... 225X	7.3	7.8	4.1
SR2 ... 474X	7.8	9.0	3.6
SR2 ... 105X	7.8	9.0	4.1
SR2 ... 155X	7.8	9.0	4.1
SR2 ... 475X	7.8	9.0	4.1
SR6 ...	6.0	7.5	4.5

**Delivery mode**

Designation	Taping mode	Ordering code, last two digits
-	Bulk	B725***** <b>00</b>
G	Taped on reel	B725***** <b>51</b>
GA	Taped in AMMO pack	B725***** <b>54</b>
M14	Lead length 14 mm	B725***** <b>33</b>

Standard delivery mode for SHCV types is bulk. Taped versions on reel, AMMO pack and special lead length available upon request.

For further information on taping please contact EPCOS.

Packing units for:

Type	Pieces
SR6	2000
SR1 / SR2	1000

### Typical characteristics

Capacitance change  $\Delta C/C_{25}$  versus temperature T

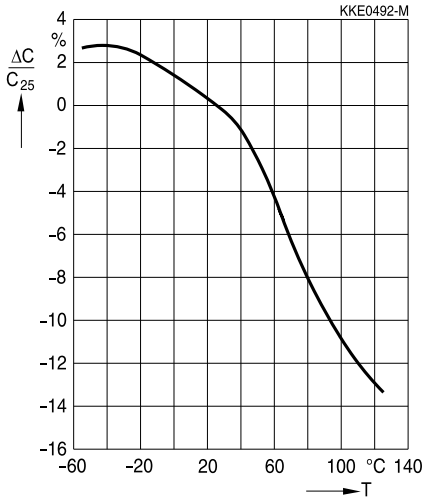

**Note:**

The capacitance and the dissipation factor shall meet the specified values 1000 hours after the last heat treatment above the curie temperature.

V/I characteristics

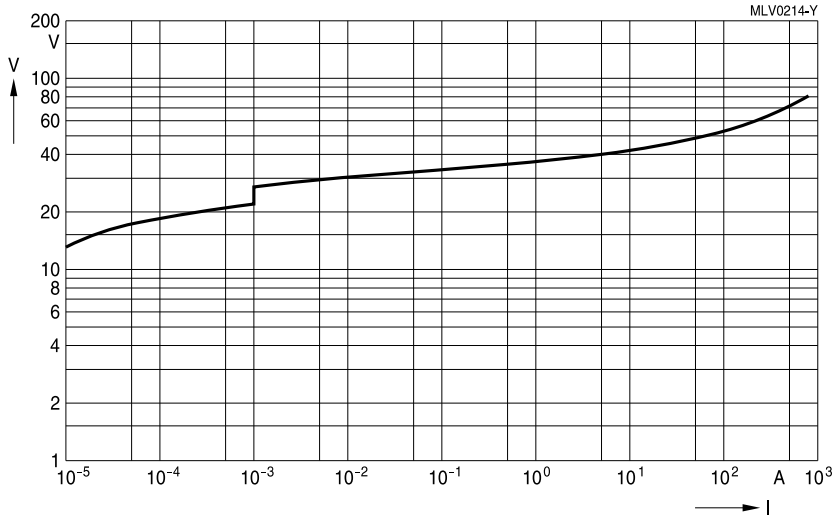

SR1S14B\*

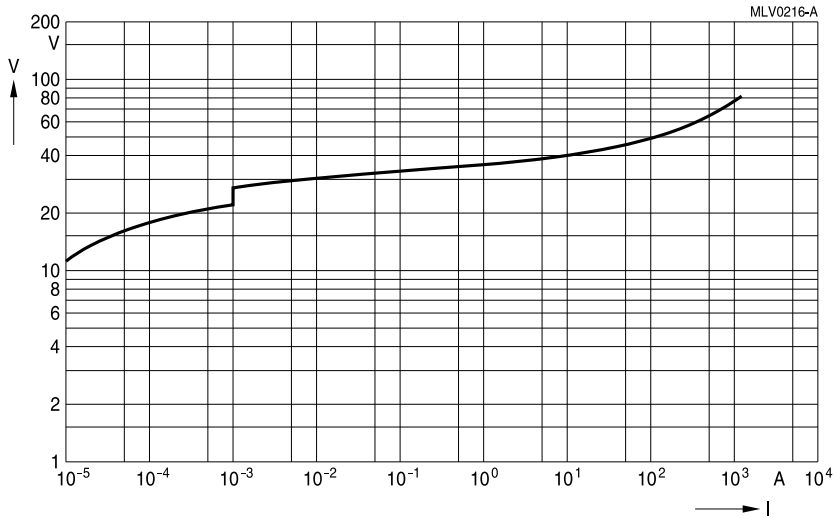

SR2S14B\*



V/I characteristics

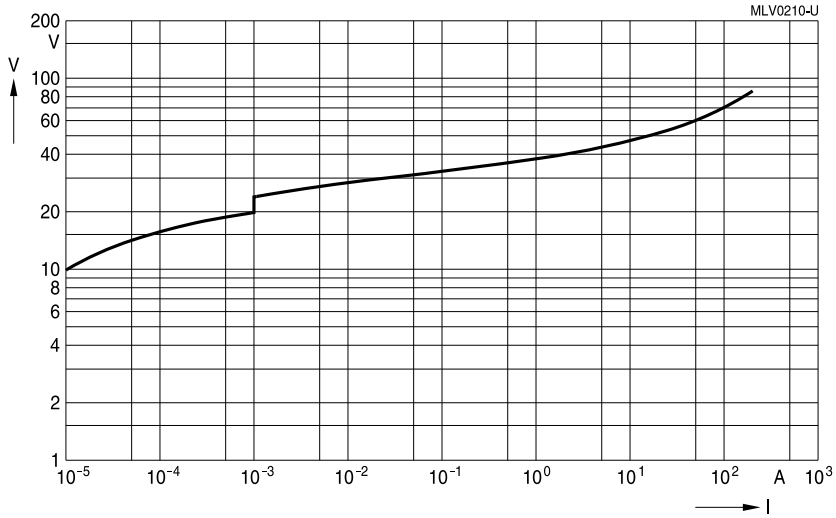

SR6K14\*

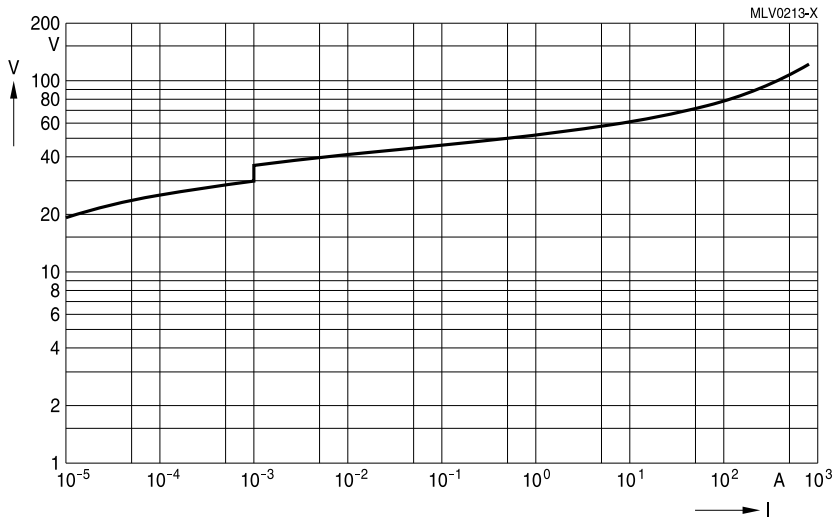

SR1K20\*

V/I characteristics

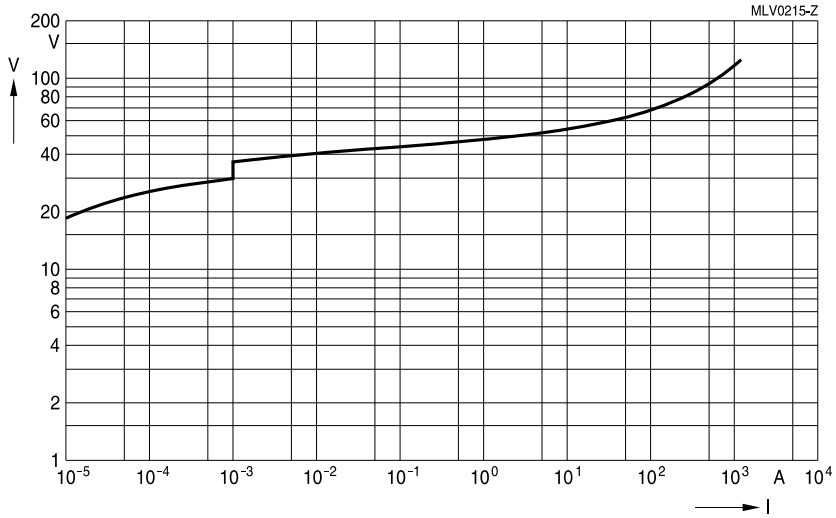

SR2K20\*

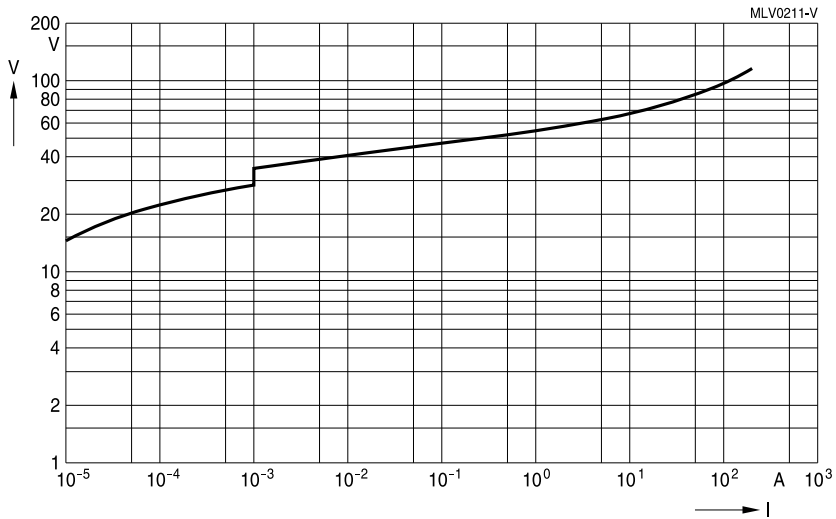

SR6K20\*

V/I characteristics

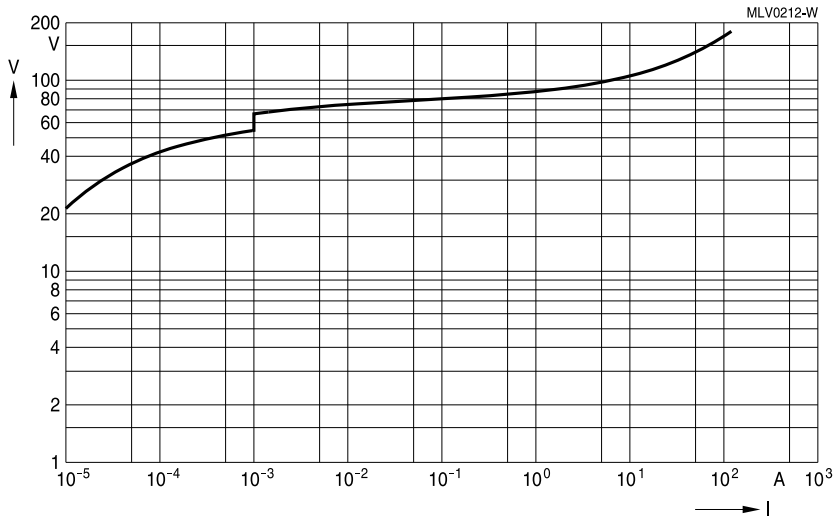

SR6K35\*

**Derating curves**

Maximum surge current  $I_{\text{surge,max}} = f(t_r, \text{pulse train})$

For explanation of the derating curves refer to "General technical information", chapter 2.7.2

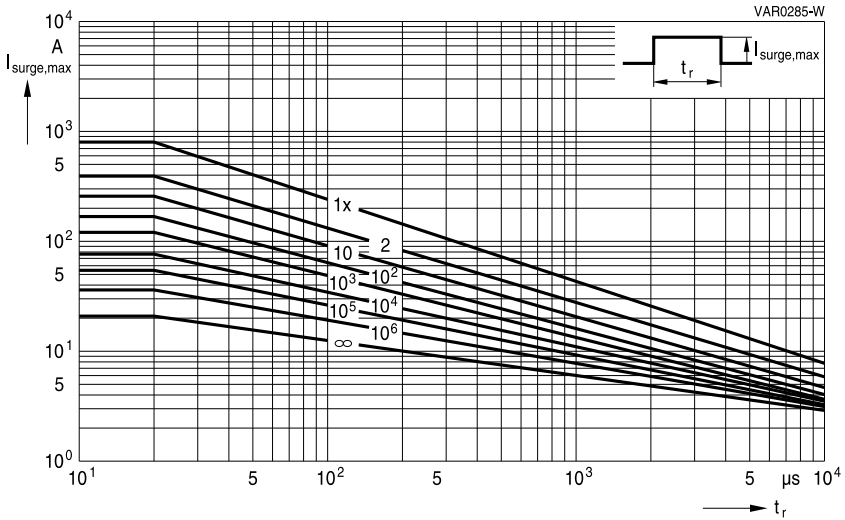

**SHCV-SR1 ...**

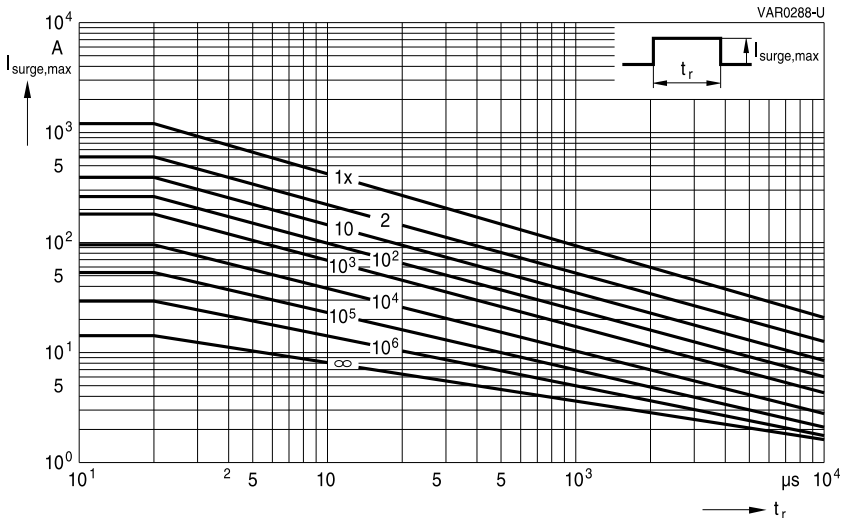

**SHCV-SR2 ...**

**Derating curves**

Maximum surge current  $I_{\text{surge,max}} = f(t_r, \text{pulse train})$

For explanation of the derating curves refer to "General technical information", chapter 2.7.2

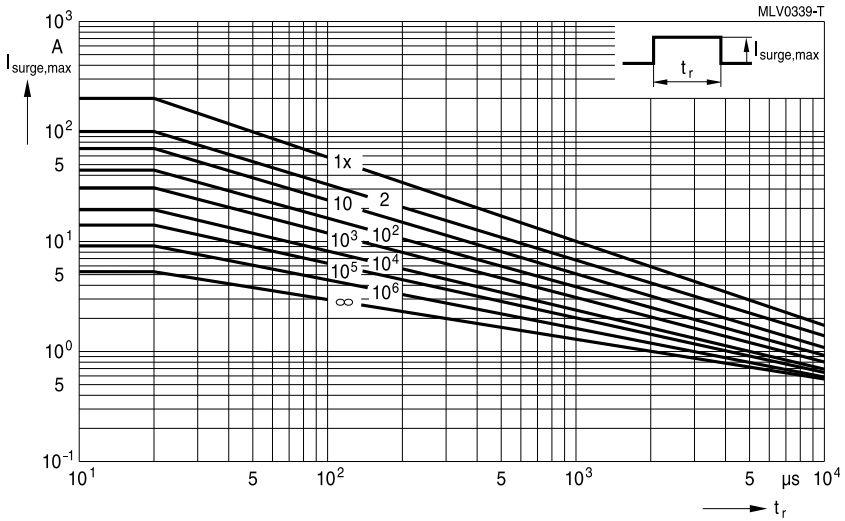

**SR6K14, SR6K20**

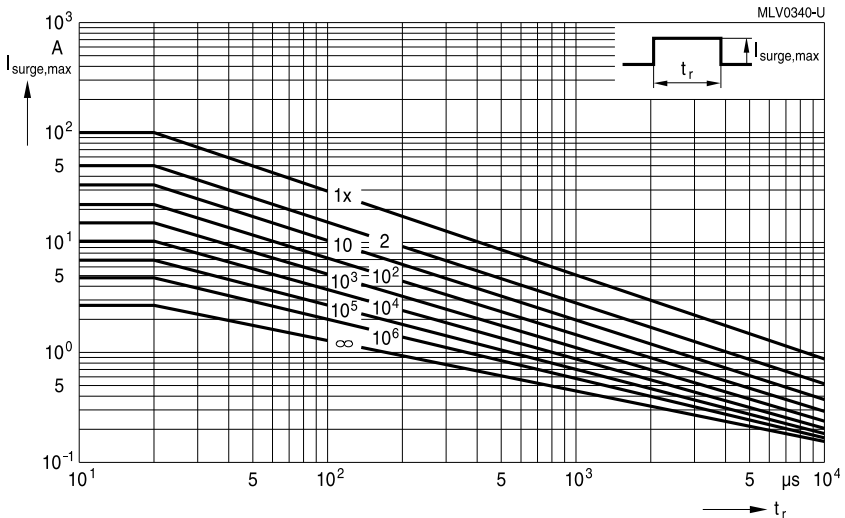

**SR6K35 ...**

**Soldering directions**

**1 Terminations**

**1.1 Nickel barrier termination**

The nickel barrier layer of the silver/nickel/tin termination prevents leaching of the silver base metallization layer. This allows great flexibility in the selection of soldering parameters. The tin prevents the nickel layer from oxidizing and thus ensures better wetting by the solder. The nickel barrier termination is suitable for all commonly-used soldering methods.

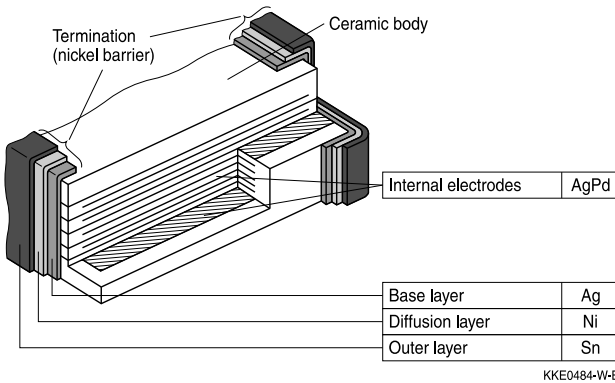

Multilayer CTVS: Structure of nickel barrier termination

**1.2 Silver-palladium termination**

Silver-palladium terminations are used for the large case sizes 1812 and 2220 and for chips intended for conductive adhesion. This metallization improves the resistance of large chips to thermal shock.

In case of conductive adhesion, the silver-palladium metallization reduces susceptibility to corrosion. Silver-palladium termination can be used for smaller case sizes (only chip) for hybrid applications as well. The silver-palladium termination is not approved for lead-free soldering.

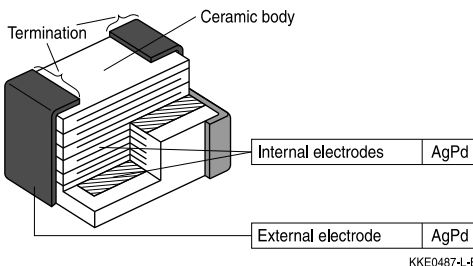

Multilayer varistor: Structure of silver-palladium termination

## 2 Recommended soldering temperature profiles

### 2.1 Reflow soldering temperature profile

#### Recommended temperature characteristic for reflow soldering following JEDEC J-STD-020D

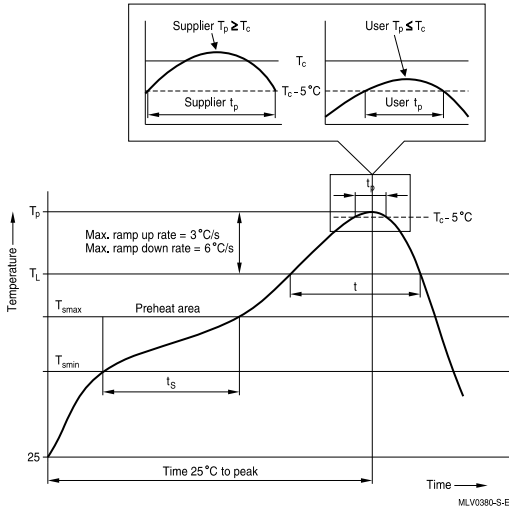

Profile feature		Sn-Pb eutectic assembly	Pb-free assembly
Preheat and soak			
- Temperature min	$T_{smin}$	100 °C	150 °C
- Temperature max	$T_{smax}$	150 °C	200 °C
- Time	$t_{smin}$ to $t_{smax}$	60 ... 120 s	60 ... 180 s
Average ramp-up rate	$T_{smax}$ to $T_p$	3 °C/ s max.	3 °C/ s max.
Liquidous temperature	$T_L$	183 °C	217 °C
Time at liquidous	$t_L$	60 ... 150 s	60 ... 150 s
Peak package body temperature	$T_p$ <sup>1)</sup>	220 °C ... 235 °C <sup>2)</sup>	245 °C ... 260 °C <sup>2)</sup>
Time ( $t_p$ ) <sup>3)</sup> within 5 °C of specified classification temperature ( $T_c$ )		20 s <sup>3)</sup>	30 s <sup>3)</sup>
Average ramp-down rate	$T_p$ to $T_{smax}$	6 °C/ s max.	6 °C/ s max.
Time 25 °C to peak temperature		maximum 6 min	maximum 8 min

1) Tolerance for peak profile temperature ( $T_p$ ) is defined as a supplier minimum and a user maximum.

2) Depending on package thickness. For details please refer to JEDEC J-STD-020D.

3) Tolerance for time at peak profile temperature ( $t_p$ ) is defined as a supplier minimum and a user maximum.

**Note:** All temperatures refer to topside of the package, measured on the package body surface.  
Number of reflow cycles: 3

**2.2 Wave soldering temperature profile**

Temperature characteristics at component terminal with dual-wave soldering

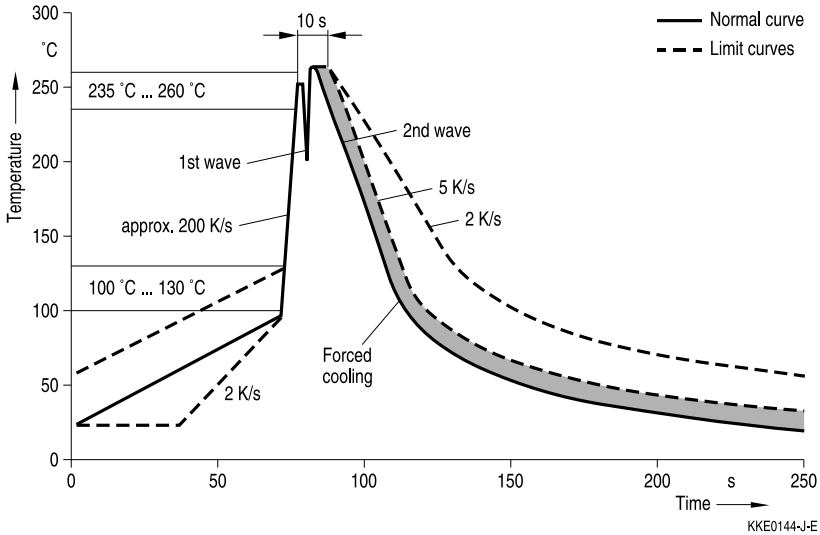

**2.3 Lead-free soldering processes**

EPCOS multilayer CTVS with AgNiSn termination are designed for the requirements of lead-free soldering processes only.

Soldering temperature profiles to JEDEC J-STD-020D, IEC 60068-2-58 and ZVEI recommendations.



### 3 Recommended soldering methods - type-specific releases by EPCOS

#### 3.1 Overview

Type	Case size	Reflow soldering		Wave soldering	
		SnPb	Lead-free	SnPb	Lead-free
CT... / CD...	0201/ 0402	Approved	Approved	No	No
CT... / CD...	0603 ... 2220	Approved	Approved	Approved	Approved
CN...	0603 ... 2220	Approved	No	Approved	No
Arrays	0405 ... 1012	Approved	Approved	No	No
ESD/EMI filters	0405, 0508	Approved	Approved	No	No
CU	3225, 4032	Approved	Approved	Approved	Approved
SHCV	-	No	No	Approved	Approved

#### 3.2 Nickel barrier terminated multilayer CTVS

All EPCOS MLVs with nickel barrier termination are suitable and fully qualified for lead-free soldering. The nickel barrier layer is 100% matte tin-plated.

#### 3.3 Silver-palladium terminated MLVs

AgPd-terminated MLVs are mainly designed for conductive adhesion technology on hybrid material. Additionally MLVs with AgPd termination are suitable for reflow and wave soldering with SnPb solder.

**Note:**

Lead-free soldering is not approved for MLVs with AgPd termination.

#### 3.4 Tinned copper alloy

All EPCOS CU types with tinned termination are approved for lead-free and SnPb soldering.

#### 3.5 Tinned iron wire

All EPCOS SHCV types with tinned termination are approved for lead-free and SnPb soldering.

### 4 Solder joint profiles / solder quantity

#### 4.1 Nickel barrier termination

If the meniscus height is too low, that means the solder quantity is too low, the solder joint may break, i.e. the component becomes detached from the joint. This problem is sometimes interpreted as leaching of the external terminations.

If the solder meniscus is too high, i.e. the solder quantity is too large, the vise effect may occur. As the solder cools down, the solder contracts in the direction of the component. If there is too much solder on the component, it has no leeway to evade the stress and may break, as in a vise.

The figures below show good and poor solder joints for dual-wave and infrared soldering.

**4.1.1 Solder joint profiles for nickel barrier termination - dual-wave soldering**

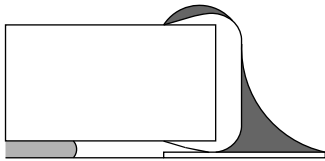

Good solder joint

KKE0287-9-E

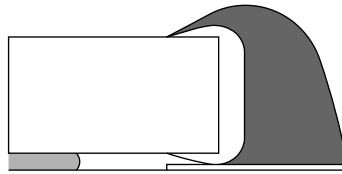

Too much solder  
Pad geometry too large,  
not soldered in preferred direction

KKE0288-H-E

Good and poor solder joints caused by amount of solder in dual-wave soldering.

**4.1.2 Solder joint profiles for nickel barrier termination / silver-palladium termination - reflow soldering**

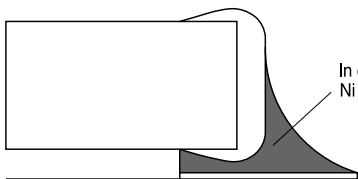

Good solder joint

MLV0196-B-E

In case of:  
Ni barrier

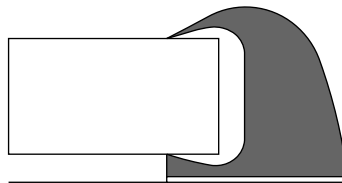

Too much solder  
Pad geometry too large

KKE0071-A-E

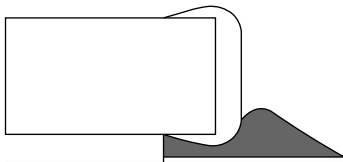

Poor wetting

KKE0072-H-E

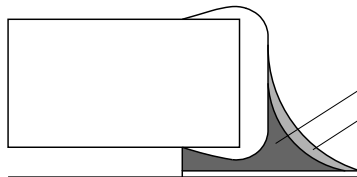

Good solder joint

KKE0070-2-E

In case of:  
Ag Pd  
Ni-Barrier

Good and poor solder joints caused by amount of solder in reflow soldering.

## 5 Conductive adhesion

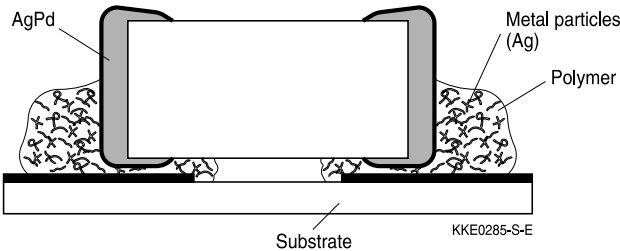

Attaching surface-mounted devices (SMDs) with electrically conductive adhesives is a commercially attractive method of component connection to supplement or even replace conventional soldering methods.

Electrically conductive adhesives consist of a non-conductive plastic (epoxy resin, polyimide or silicon) in which electrically conductive metal particles (gold, silver, palladium, nickel, etc) are embedded. Electrical conduction is effected by contact between the metal particles.

Adhesion is particularly suitable for meeting the demands of hybrid technology. The adhesives can be deposited ready for production requirements by screen printing, stamping or by dispensers. As shown in the following table, conductive adhesion involves two work operations fewer than soldering.

Reflow soldering	Wave soldering	Conductive adhesion
Screen-print solder paste	Apply glue dot	Screen-print conductive adhesive
Mount SMD	Mount SMD	Mount SMD
Predry solder paste	Cure glue	Cure adhesive
Reflow soldering	Wave soldering	Inspect
Wash	Wash	
Inspect	Inspect	

A further advantage of adhesion is that the components are subjected to virtually no temperature shock at all. The curing temperatures of the adhesives are between 120 °C and 180 °C, typical curing times are between 30 minutes and one hour.

The bending strength of glued chips is, in comparison with that of soldered chips, higher by a factor of at least 2, as is to be expected due to the elasticity of the glued joints.

The lower conductivity of conductive adhesive may lead to higher contact resistance and thus result in electrical data different to those of soldered components. Users must pay special attention to this in RF applications.

**Leaded transient voltage/RFI suppressors (SHCVs)**
**SHCV series**
**6 Solderability tests**

Test	Standard	Test conditions Sn-Pb soldering	Test conditions Pb-free soldering	Criteria/ test results
Wettability	IEC 60068-2-58	Immersion in 60/40 SnPb solder using non-activated flux at $215 \pm 3$ °C for $3 \pm 0.3$ s	Immersion in Sn96.5Ag3.0Cu0.5 solder using non- or low activated flux at $245 \pm 5$ °C for $3 \pm 0.3$ s	Covering of 95% of end termination, checked by visual inspection
Leaching resistance	IEC 60068-2-58	Immersion in 60/40 SnPb solder using mildly activated flux without preheating at $260 \pm 5$ °C for $10 \pm 1$ s	Immersion in Sn96.5Ag3.0Cu0.5 solder using non- or low activated flux without preheating at $255 \pm 5$ °C for $10 \pm 1$ s	No leaching of contacts
Thermal shock (solder shock)		Dip soldering at $300$ °C/5 s	Dip soldering at $300$ °C/5 s	No deterioration of electrical parameters. Capacitance change: $\leq \pm 15\%$
Tests of resistance to soldering heat for SMDs	IEC 60068-2-58	Immersion in 60/40 SnPb for 10 s at $260$ °C	Immersion in Sn96.5Ag3.0Cu0.5 for 10 s at $260$ °C	Change of varistor voltage: $\leq \pm 5\%$
Tests of resistance to soldering heat for radial leaded components (SHCV)	IEC 60068-2-20	Immersion of leads in 60/40 SnPb for 10 s at $260$ °C	Immersion of leads in Sn96.5Ag3.0Cu0.5 for 10 s at $260$ °C	Change of varistor voltage: $\leq \pm 5\%$ Change of capacitance X7R: $\leq -5/+10\%$

**Note:**

**Leaching of the termination**

Effective area at the termination might be lost if the soldering temperature and/or immersion time are not kept within the recommended conditions. Leaching of the outer electrode should not exceed 25% of the chip end area (full length of the edge A-B-C-D) and 25% of the length A-B, shown below as mounted on substrate.

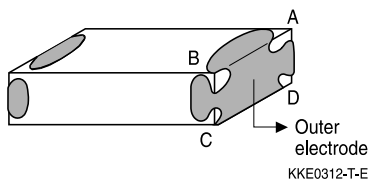

As a single chip

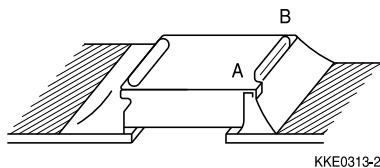

As mounted on substrate

**7 Notes for proper soldering**

**7.1 Preheating and cooling**

- According to JEDEC J-STD-020D. Please refer to chapter 2.

**7.2 Repair / rework**

Manual soldering with a soldering iron must be avoided, hot-air methods are recommended for rework purposes.

**7.3 Cleaning**

All environmentally compatible agents are suitable for cleaning. Select the appropriate cleaning solution according to the type of flux used. The temperature difference between the components and cleaning liquid must not be greater than 100 °C. Ultrasonic cleaning should be carried out with the utmost caution. Too high ultrasonic power can impair the adhesive strength of the metalized surfaces.

**7.4 Solder paste printing (reflow soldering)**

An excessive application of solder paste results in too high a solder fillet, thus making the chip more susceptible to mechanical and thermal stress. Too little solder paste reduces the adhesive strength on the outer electrodes and thus weakens the bonding to the PCB. The solder should be applied smoothly to the end surface.

## 7.5 Adhesive application

Thin or insufficient adhesive causes chips to loosen or become disconnected during curing. Low viscosity of the adhesive causes chips to slip after mounting. It is advised to consult the manufacturer of the adhesive on proper usage and amounts of adhesive to use.

## 7.6 Selection of flux

Used flux should have less than or equal to 0.1 wt % of halogenated content, since flux residue after soldering could lead to corrosion of the termination and/or increased leakage current on the surface of the component. Strong acidic flux must not be used. The amount of flux applied should be carefully controlled, since an excess may generate flux gas, which in turn is detrimental to solderability.

## 7.7 Storage of CTVs

Solderability is guaranteed for one year from date of delivery for multilayer varistors, CeraDiodes and ESD/EMI filters (half a year for chips with AgPd terminations) and two years for SHCV and CU components, provided that components are stored in their original packages.

Storage temperature:  $-25\text{ °C}$  to  $+45\text{ °C}$

Relative humidity:  $\leq 75\%$  annual average,  $\leq 95\%$  on 30 days a year

The solderability of the external electrodes may deteriorate if SMDs and leaded components are stored where they are exposed to high humidity, dust or harmful gas (hydrogen chloride, sulfuric acid gas or hydrogen sulfide).

Do not store SMDs and leaded components where they are exposed to heat or direct sunlight. Otherwise the packing material may be deformed or SMDs/ leaded components may stick together, causing problems during mounting.

After opening the factory seals, such as polyvinyl-sealed packages, it is recommended to use the SMDs or leaded components as soon as possible.

## 7.8 Placement of components on circuit board

Especially in the case of dual-wave soldering, it is of advantage to place the components on the board before soldering in that way that their two terminals do not enter the solder bath at different times.

Ideally, both terminals should be wetted simultaneously.

## 7.9 Soldering cautions

- An excessively long soldering time or high soldering temperature results in leaching of the outer electrodes, causing poor adhesion and a change of electrical properties of the varistor due to the loss of contact between electrodes and termination.
- Wave soldering must not be applied for MLVs designated for reflow soldering only.
- Keep the recommended down-cooling rate.

### **7.10 Standards**

CECC 00802

IEC 60068-2-58

IEC 60068-2-20

JEDEC J-STD-020D

**Leaded transient voltage/RFI suppressors (SHCVs)**
**SHCV series**
**Symbols and terms**

Symbol	Term
$C_{\text{line,typ}}$	Typical capacitance per line
$C_{\text{max}}$	Maximum capacitance
$C_{\text{min}}$	Minimum capacitance
$C_{\text{nom}}$	Nominal capacitance
$\Delta C_{\text{nom}}$	Tolerance of nominal capacitance
$C_{\text{typ}}$	Typical capacitance
$f_{\text{cut-off,min}}$	Minimum cut-off frequency
$I$	Current
$I_{\text{clamp}}$	Clamping current
$I_{\text{leak}}$	Leakage current
$I_{\text{leak,typ}}$	Typical leakage current
$I_{\text{PP}}$	Peak pulse current
$I_{\text{surge,max}}$	Maximum surge current (also termed peak current)
LCT	Lower category temperature
$L_{\text{typ}}$	Typical inductance
$P_{\text{diss,max}}$	Maximum power dissipation
$P_{\text{PP}}$	Peak pulse power
$R_{\text{ins}}$	Insulation resistance
$R_{\text{min}}$	Minimum resistance
$R_{\text{S}}$	Resistance per line
$T_{\text{A}}$	Ambient temperature
$T_{\text{op}}$	Operating temperature
$T_{\text{stg}}$	Storage temperature
$t_{\text{r}}$	Duration of equivalent rectangular wave
$t_{\text{resp}}$	Response time
UCT	Upper category temperature
$V$	Voltage
$V_{\text{BR,min}}$	Minimum breakdown voltage
$V_{\text{clamp,max}}$	Maximum clamping voltage
$V_{\text{DC,max}}$	Maximum DC operating voltage (also termed working voltage)
$V_{\text{ESD,air}}$	Air discharge ESD capability
$V_{\text{ESD,contact}}$	Contact discharge ESD capability
$V_{\text{jump}}$	Maximum jump start voltage



**Leaded transient voltage/RFI suppressors (SHCVs)**
**SHCV series**

$V_{\text{RMS,max}}$	Maximum AC operating voltage, root-mean-square value
$V_V$	Varistor voltage (also termed breakdown voltage)
$V_{V,\text{min}}$	Minimum varistor voltage
$V_{V,\text{max}}$	Maximum varistor voltage
$\Delta V_V$	Tolerance of varistor voltage
$W_{\text{LD}}$	Maximum load dump
$W_{\text{max}}$	Maximum energy absorption (also termed transient energy)
$\alpha_{\text{typ}}$	Typical insertion loss
$e$	Lead spacing
$\ll * \gg$	Maximum possible application conditions

All dimensions are given in mm.

The commas used in numerical values denote decimal points.

## Cautions and warnings

### General

Some parts of this publication contain statements about the suitability of our ceramic transient voltage suppressor (CTVS) components (multilayer varistors (MLVs), CeraDiodes, ESD/EMI filters, SMD disk varistors (CU types), leaded transient voltage/ RFI suppressors (SHCV types)) for certain areas of application, including recommendations about incorporation/design-in of these products into customer applications. The statements are based on our knowledge of typical requirements often made of our CTVS devices in the particular areas. We nevertheless expressly point out that such statements cannot be regarded as binding statements about the suitability of our CTVS components for a particular customer application. As a rule, EPCOS is either unfamiliar with individual customer applications or less familiar with them than the customers themselves. For these reasons, it is always incumbent on the customer to check and decide whether the CTVS devices with the properties described in the product specification are suitable for use in a particular customer application.

- Do not use EPCOS CTVS components for purposes not identified in our specifications, application notes and data books.
- Ensure the suitability of a CTVS in particular by testing it for reliability during design-in. Always evaluate a CTVS component under worst-case conditions.
- Pay special attention to the reliability of CTVS devices intended for use in safety-critical applications (e.g. medical equipment, automotive, spacecraft, nuclear power plant).

### Design notes

- Always connect a CTVS in parallel with the electronic circuit to be protected.
- Consider maximum rated power dissipation if a CTVS has insufficient time to cool down between a number of pulses occurring within a specified isolated time period. Ensure that electrical characteristics do not degrade.
- Consider derating at higher operating temperatures. Choose the highest voltage class compatible with derating at higher temperatures.
- Surge currents beyond specified values will puncture a CTVS. In extreme cases a CTVS will burst.
- If steep surge current edges are to be expected, make sure your design is as low-inductance as possible.
- In some cases the malfunctioning of passive electronic components or failure before the end of their service life cannot be completely ruled out in the current state of the art, even if they are operated as specified. In applications requiring a very high level of operational safety and especially when the malfunction or failure of a passive electronic component could endanger human life or health (e.g. in accident prevention, life-saving systems, or automotive battery line applications such as clamp 30), ensure by suitable design of the application or other measures (e.g. installation of protective circuitry or redundancy) that no injury or damage is sustained by third parties in the event of such a malfunction or failure. Only use CTVS components from the automotive series in safety-relevant applications.
- Specified values only apply to CTVS components that have not been subject to prior electrical, mechanical or thermal damage. The use of CTVS devices in line-to-ground applications is

therefore not advisable, and it is only allowed together with safety countermeasures like thermal fuses.

### Storage

- Only store CTVS in their original packaging. Do not open the package before storage.
- Storage conditions in original packaging: temperature  $-25$  to  $+45^{\circ}\text{C}$ , relative humidity  $\leq 75\%$  annual average, maximum 95%, dew precipitation is inadmissible.
- Do not store CTVS devices where they are exposed to heat or direct sunlight. Otherwise the packaging material may be deformed or CTVS may stick together, causing problems during mounting.
- Avoid contamination of the CTVS surface during storage, handling and processing.
- Avoid storing CTVS devices in harmful environments where they are exposed to corrosive gases for example ( $\text{SO}_x$ , Cl).
- Use CTVS as soon as possible after opening factory seals such as polyvinyl-sealed packages.
- Solder CTVS components after shipment from EPCOS within the time specified:
  - CTVS with Ni barrier termination, 12 months
  - CTVS with AgPd termination, 6 months
  - SHCV and CU series, 24 months

### Handling

- Do not drop CTVS components and allow them to be chipped.
- Do not touch CTVS with your bare hands - gloves are recommended.
- Avoid contamination of the CTVS surface during handling.

### Mounting

- When CTVS devices are encapsulated with sealing material or overmolded with plastic material, electrical characteristics might be degraded and the life time reduced.
- Make sure an electrode is not scratched before, during or after the mounting process.
- Make sure contacts and housings used for assembly with CTVS components are clean before mounting.
- The surface temperature of an operating CTVS can be higher. Ensure that adjacent components are placed at a sufficient distance from a CTVS to allow proper cooling.
- Avoid contamination of the CTVS surface during processing.
- Multilayer varistors (MLVs) with AgPd termination are not approved for lead-free soldering.

### Soldering

- Complete removal of flux is recommended to avoid surface contamination that can result in an instable and/or high leakage current.
- Use resin-type or non-activated flux.
- Bear in mind that insufficient preheating may cause ceramic cracks.
- Rapid cooling by dipping in solvent is not recommended, otherwise a component may crack.

### Conductive adhesive gluing

- Only multilayer varistors (MLVs) with an AgPd termination are approved for conductive adhesive gluing.

### Operation

- Use CTVS only within the specified operating temperature range.
- Use CTVS only within specified voltage and current ranges.
- Environmental conditions must not harm a CTVS. Only use them in normal atmospheric conditions. Reducing the atmosphere (e.g. hydrogen or nitrogen atmosphere) is prohibited.
- Prevent a CTVS from contacting liquids and solvents. Make sure that no water enters a CTVS (e.g. through plug terminals).
- Avoid dewing and condensation.
- EPCOS CTVS components are mainly designed for encased applications. Under all circumstances avoid exposure to:
  - direct sunlight
  - rain or condensation
  - steam, saline spray
  - corrosive gases
  - atmosphere with reduced oxygen content
- EPCOS CTVS devices are not suitable for switching applications or voltage stabilization where static power dissipation is required.
- Multilayer varistors (MLVs) are designed for ESD protection and transient suppression. CeraDiodes are designed for ESD protection only, ESD/EMI filters are designed for ESD and EMI protection only.

This listing does not claim to be complete, but merely reflects the experience of EPCOS AG.

## Important notes

The following applies to all products named in this publication:

1. Some parts of this publication contain **statements about the suitability of our products for certain areas of application**. These statements are based on our knowledge of typical requirements that are often placed on our products in the areas of application concerned. We nevertheless expressly point out **that such statements cannot be regarded as binding statements about the suitability of our products for a particular customer application**. As a rule, EPCOS is either unfamiliar with individual customer applications or less familiar with them than the customers themselves. For these reasons, it is always ultimately incumbent on the customer to check and decide whether an EPCOS product with the properties described in the product specification is suitable for use in a particular customer application.
2. We also point out that **in individual cases, a malfunction of electronic components or failure before the end of their usual service life cannot be completely ruled out in the current state of the art, even if they are operated as specified**. In customer applications requiring a very high level of operational safety and especially in customer applications in which the malfunction or failure of an electronic component could endanger human life or health (e.g. in accident prevention or lifesaving systems), it must therefore be ensured by means of suitable design of the customer application or other action taken by the customer (e.g. installation of protective circuitry or redundancy) that no injury or damage is sustained by third parties in the event of malfunction or failure of an electronic component.
3. **The warnings, cautions and product-specific notes must be observed.**
4. In order to satisfy certain technical requirements, **some of the products described in this publication may contain substances subject to restrictions in certain jurisdictions (e.g. because they are classed as hazardous)**. Useful information on this will be found in our Material Data Sheets on the Internet ([www.epcos.com/material](http://www.epcos.com/material)). Should you have any more detailed questions, please contact our sales offices.
5. We constantly strive to improve our products. Consequently, **the products described in this publication may change from time to time**. The same is true of the corresponding product specifications. Please check therefore to what extent product descriptions and specifications contained in this publication are still applicable before or when you place an order. We also **reserve the right to discontinue production and delivery of products**. Consequently, we cannot guarantee that all products named in this publication will always be available. The aforementioned does not apply in the case of individual agreements deviating from the foregoing for customer-specific products.
6. Unless otherwise agreed in individual contracts, **all orders are subject to the current version of the "General Terms of Delivery for Products and Services in the Electrical Industry" published by the German Electrical and Electronics Industry Association (ZVEI)**.
7. The trade names EPCOS, BAOKE, Alu-X, CeraDiode, CSSP, CTVS, DSSP, MiniBlue, MKK, MLSC, MotorCap, PCC, PhaseCap, PhaseMod, SIFERRIT, SIFI, SIKOREL, SilverCap, SIMDAD, SIMID, SineFormer, SIOV, SIP5D, SIP5K, ThermoFuse, WindCap are **trademarks registered or pending** in Europe and in other countries. Further information will be found on the Internet at [www.epcos.com/trademarks](http://www.epcos.com/trademarks).



Компания «ЭлектроПласт» предлагает заключение долгосрочных отношений при поставках импортных электронных компонентов на взаимовыгодных условиях!

Наши преимущества:

- Оперативные поставки широкого спектра электронных компонентов отечественного и импортного производства напрямую от производителей и с крупнейших мировых складов;
- Поставка более 17-ти миллионов наименований электронных компонентов;
- Поставка сложных, дефицитных, либо снятых с производства позиций;
- Оперативные сроки поставки под заказ (от 5 рабочих дней);
- Экспресс доставка в любую точку России;
- Техническая поддержка проекта, помощь в подборе аналогов, поставка прототипов;
- Система менеджмента качества сертифицирована по Международному стандарту ISO 9001;
- Лицензия ФСБ на осуществление работ с использованием сведений, составляющих государственную тайну;
- Поставка специализированных компонентов (Xilinx, Altera, Analog Devices, Intersil, Interpoint, Microsemi, Aeroflex, Peregrine, Syfer, Eurofarad, Texas Instrument, Miteq, Cobham, E2V, MA-COM, Hittite, Mini-Circuits, General Dynamics и др.);

Помимо этого, одним из направлений компании «ЭлектроПласт» является направление «Источники питания». Мы предлагаем Вам помощь Конструкторского отдела:

- Подбор оптимального решения, техническое обоснование при выборе компонента;
- Подбор аналогов;
- Консультации по применению компонента;
- Поставка образцов и прототипов;
- Техническая поддержка проекта;
- Защита от снятия компонента с производства.



#### Как с нами связаться

**Телефон:** 8 (812) 309 58 32 (многоканальный)

**Факс:** 8 (812) 320-02-42

**Электронная почта:** [org@eplast1.ru](mailto:org@eplast1.ru)

**Адрес:** 198099, г. Санкт-Петербург, ул. Калинина, дом 2, корпус 4, литера А.