

4A, 600V - 1000V Glass Passivated Bridge Rectifier

FEATURES

- Glass passivated junction
- Ideal for automated placement
- UL Recognized File # E-326854
- Moisture sensitivity level: level 1, per J-STD-020
- Compliant to RoHS directive 2011/65/EU and in accordance to WEEE 2002/96/EC
- Halogen-free according to IEC 61249-2-21

APPLICATIONS

- Switching mode power supply (SMPS)
- Adapters
- TV
- Monitor

MECHANICAL DATA

- Case: TBS
- Molding compound meets UL 94V-0 flammability rating
- Matte tin plated leads, solderable per J-STD-002
- Meet JESD 201 class 1 whisker test
- Polarity: As marked
- Weight: 0.22g (approximately)

KEY PARAMETERS		
PARAMETER	VALUE	UNIT
$I_{F(AV)}$	4.0	A
V_{RRM}	600 - 1000	V
I_{FSM}	110	A
T_{JMAX}	150	°C
Package	TBS	
Configuration	Quad	

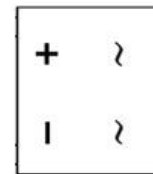
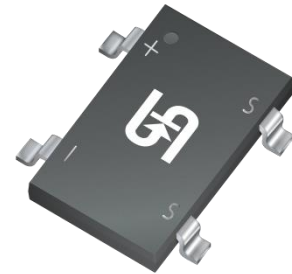

TBS

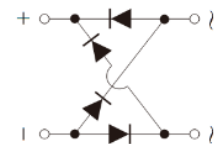

ABSOLUTE MAXIMUM RATINGS ($T_A = 25^\circ\text{C}$ unless otherwise noted)					
PARAMETER	SYMBOL	TBS 406	TBS 408	TBS 410	UNIT
Marking code on the device		TBS406	TBS408	TBS410	
Repetitive peak reverse voltage	V_{RRM}	600	800	1000	V
Reverse voltage, total rms value	$V_{R(RMS)}$	420	560	700	V
Forward current	$I_{F(AV)}$	4.0			A
Surge peak forward current single half sine-wave superimposed on rated load	8.3 ms at $T_A = 25^\circ\text{C}$	110			A
	1.0 ms at $T_A = 25^\circ\text{C}$	340			A
I^2t value (of a surge on-state current) at 8.3ms	I^2t	50			A^2s
Junction temperature	T_J	-55 to +150			°C
Storage temperature	T_{STG}	-55 to +150			°C

THERMAL PERFORMANCE			
PARAMETER	SYMBOL	TYP	UNIT
Junction-to-lead thermal resistance	$R_{\theta JL}$	13	°C/W
Junction-to-ambient thermal resistance	$R_{\theta JA}$	50	°C/W
Junction-to-case thermal resistance	$R_{\theta JC}$	13	°C/W

Thermal Performance Note: Units mounted on recommended PCB (16mm x 16mm Cu pad test board)

ELECTRICAL SPECIFICATIONS ($T_A = 25^\circ\text{C}$ unless otherwise noted)					
PARAMETER	CONDITIONS	SYMBOL	TYP	MAX	UNIT
Forward voltage ⁽¹⁾	$I_F = 2.0\text{ A}, T_J = 25^\circ\text{C}$	V_F	0.89	-	V
	$I_F = 4.0\text{ A}, T_J = 25^\circ\text{C}$		0.95	1	V
	$I_F = 2.0\text{ A}, T_J = 125^\circ\text{C}$		0.78	-	V
	$I_F = 4.0\text{ A}, T_J = 125^\circ\text{C}$		0.84	0.96	V
Reverse current @ rated V_R ⁽²⁾	$T_J = 25^\circ\text{C}$	I_R	-	2	μA
	$T_J = 125^\circ\text{C}$		-	200	μA
Junction capacitance	1 MHz, $V_R = 4.0\text{V}$	C_J	38	-	pF

Notes:

1. Pulse test with $PW = 0.3\text{ ms}$
2. Pulse test with $PW = 30\text{ ms}$

ORDERING INFORMATION		
ORDERING CODE	PACKAGE	PACKING
TBS406 M1G	TBS	1,800 / 13" Plastic Reel
TBS408 M1G	TBS	1,800 / 13" Plastic Reel
TBS410 M1G	TBS	1,800 / 13" Plastic Reel

CHARACTERISTICS CURVES

($T_A = 25^\circ\text{C}$ unless otherwise noted)

Fig.1 Forward Current Derating Curve

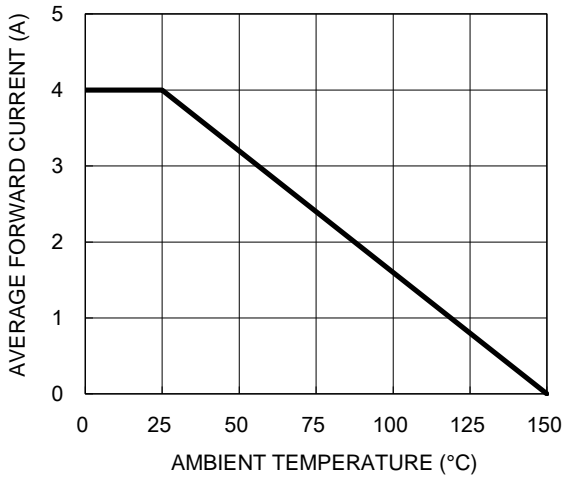

Fig.2 Typical Junction Capacitance

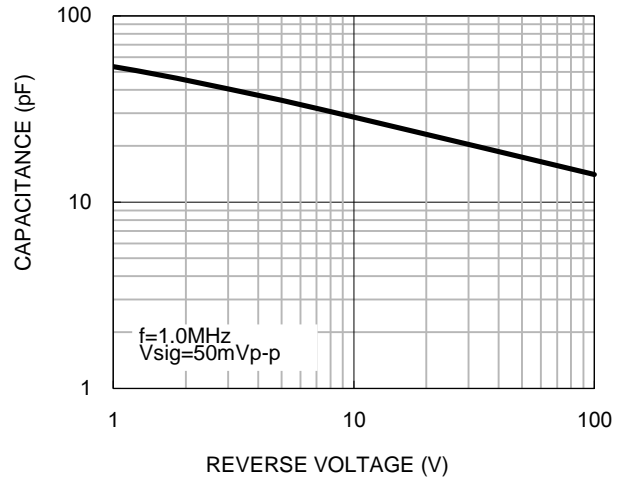

Fig.3 Typical Reverse Characteristics

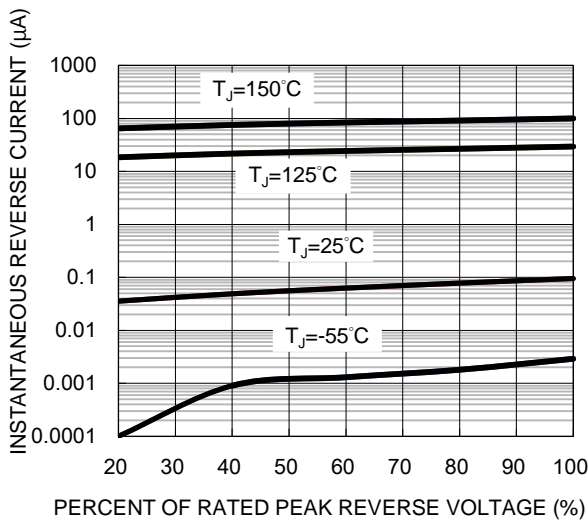
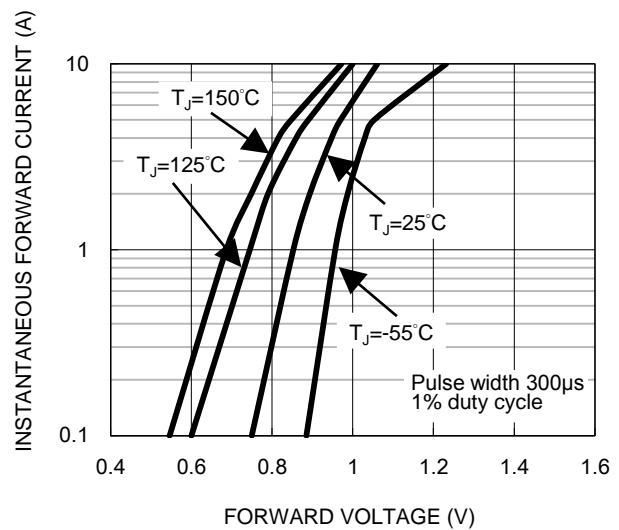
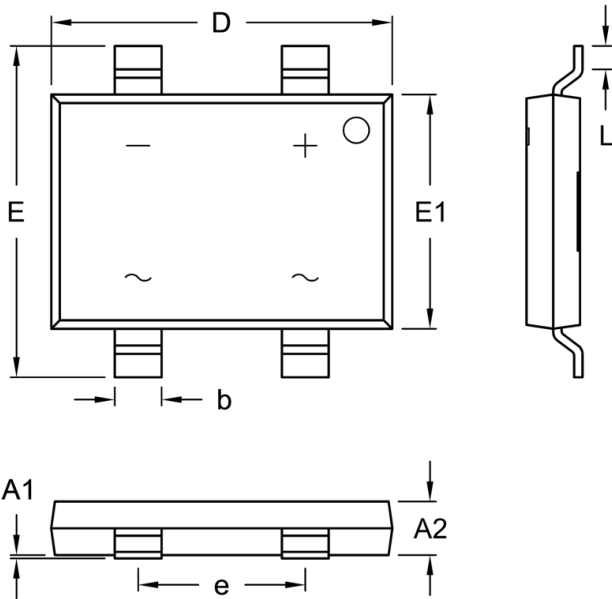

Fig.4 Typical Forward Characteristics



PACKAGE OUTLINE DIMENSIONS



DIM	Unit (mm)		Unit (inch)	
	Min	Max	Min	Max
A1	0.00	0.15	0.000	0.006
A2	1.40	1.80	0.055	0.071
b	1.30	1.50	0.051	0.059
D	10.00	10.40	0.394	0.409
E	9.70	10.10	0.382	0.398
E1	6.80	7.20	0.268	0.283
e	4.90	5.10	0.193	0.201
L	0.50	1.10	0.020	0.043

SUGGESTED PAD LAYOUT

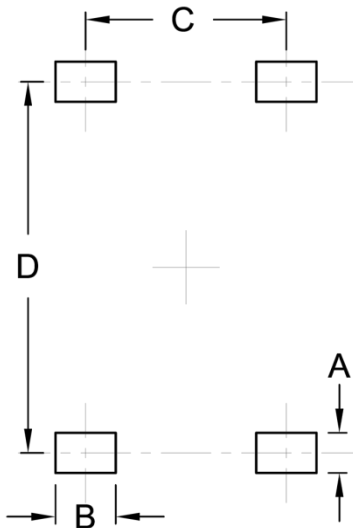

Symbol	Unit (mm)	Unit (inch)
A	1.00	0.039
B	1.50	0.059
C	5.00	0.197
D	9.25	0.364

MARKING DIAGRAM



P/N = Marking Code
 YW = Date Code
 F = Factory Code

Notice

Specifications of the products displayed herein are subject to change without notice. TSC or anyone on its behalf, assumes no responsibility or liability for any errors or inaccuracies.

Purchasers are solely responsible for the choice, selection, and use of TSC products and TSC assumes no liability for application assistance or the design of Purchasers' products.

Information contained herein is intended to provide a product description only. No license, express or implied, to any intellectual property rights is granted by this document. Except as provided in TSC's terms and conditions of sale for such products, TSC assumes no liability whatsoever, and disclaims any express or implied warranty, relating to sale and/or use of TSC products including liability or warranties relating to fitness for a particular purpose, merchantability, or infringement of any patent, copyright, or other intellectual property right.

The products shown herein are not designed for use in medical, life-saving, or life-sustaining applications. Customers using or selling these products for use in such applications do so at their own risk and agree to fully indemnify TSC for any damages resulting from such improper use or sale.



Компания «ЭлектроПласт» предлагает заключение долгосрочных отношений при поставках импортных электронных компонентов на взаимовыгодных условиях!

Наши преимущества:

- Оперативные поставки широкого спектра электронных компонентов отечественного и импортного производства напрямую от производителей и с крупнейших мировых складов;
- Поставка более 17-ти миллионов наименований электронных компонентов;
- Поставка сложных, дефицитных, либо снятых с производства позиций;
- Оперативные сроки поставки под заказ (от 5 рабочих дней);
- Экспресс доставка в любую точку России;
- Техническая поддержка проекта, помощь в подборе аналогов, поставка прототипов;
- Система менеджмента качества сертифицирована по Международному стандарту ISO 9001;
- Лицензия ФСБ на осуществление работ с использованием сведений, составляющих государственную тайну;
- Поставка специализированных компонентов (Xilinx, Altera, Analog Devices, Intersil, Interpoint, Microsemi, Aeroflex, Peregrine, Syfer, Eurofarad, Texas Instrument, Miteq, Cobham, E2V, MA-COM, Hittite, Mini-Circuits, General Dynamics и др.);

Помимо этого, одним из направлений компании «ЭлектроПласт» является направление «Источники питания». Мы предлагаем Вам помощь Конструкторского отдела:

- Подбор оптимального решения, техническое обоснование при выборе компонента;
- Подбор аналогов;
- Консультации по применению компонента;
- Поставка образцов и прототипов;
- Техническая поддержка проекта;
- Защита от снятия компонента с производства.



Как с нами связаться

Телефон: 8 (812) 309 58 32 (многоканальный)

Факс: 8 (812) 320-02-42

Электронная почта: org@eplast1.ru

Адрес: 198099, г. Санкт-Петербург, ул. Калинина, дом 2, корпус 4, литера А.