

HLMP-D150, HLMP-D155, HLMP-K150 and HLMP-K155

T-13/4 (5 mm), T-1 (3 mm), Low Current, Double Heterojunction
AlGaAs Red LED Lamps



Data Sheet

Description

These solid state LED lamps utilize double heterojunction (DH) AlGaAs/GaAs material technology. This LED material has outstanding light output efficiency at very low drive currents. The color is deep red at the dominant wavelength of 637 nanometres. These lamps are ideally suited for use in applications where high light output is required with minimum power output.

Features

- Minimum luminous intensity specified at 1 mA
- High light output at low currents
- Wide viewing angle
- Outstanding material efficiency
- Low power/low forward voltage
- CMOS/MOS compatible
- TTL compatible
- Deep red color

Applications

- Low power circuits
- Battery powered equipment
- Telecommunication indicators

Package Dimensions

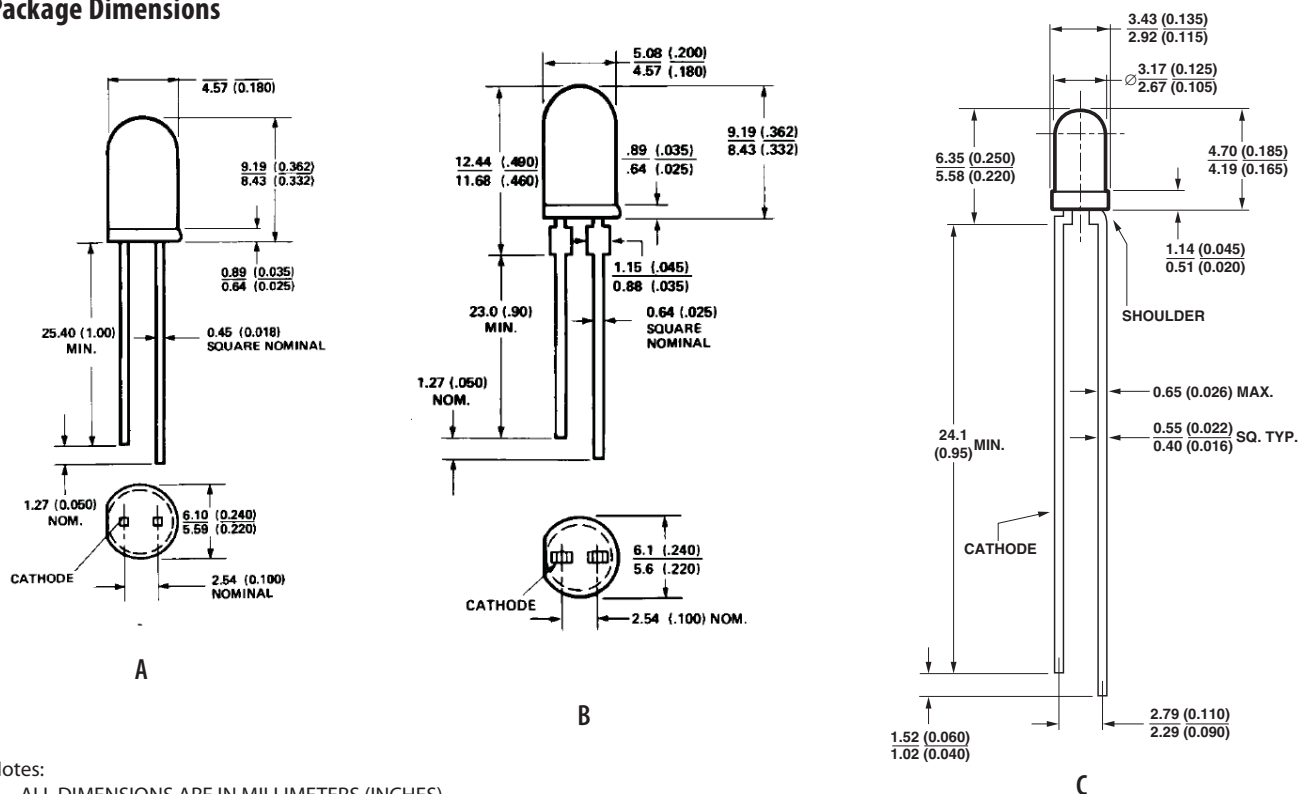

Notes:

1. ALL DIMENSIONS ARE IN MILLIMETERS (INCHES)
2. AN EPOXY MENISCUS MAY EXTEND ABOUT 1mm MAX. DOWN THE LEADS

Selection Guide

Package Description	Device HLMP-	Luminous Intensity Iv (mcd) at 1 mA			2θ _{1/2} ^[1] Degree	Package Outline
		Min.	Typ.	Max.		
T-1 3/4 Red Tinted Diffused	D150	1.3	3.0	–	65	A
	D150-C00xx	1.3	3.0	–	65	A
	D150-CD0xx	1.3	3.0	4.2	65	A
T-1 3/4 Red Untinted Non-diffused	D155	5.4	10.0	–	24	B
	D155-F00xx	5.4	10.0	–	24	B
T-1 Red Tinted Diffused	K150	1.3	2.0	–	60	C
	K150-C00xx	1.3	2.0	–	60	C
	K150-CD0xx	1.3	3.0	4.2	60	C
T-1 Red Untinted Non-diffused	K155	2.1	3.0	–	45	C
	K155-CD0xx	1.3	3.0	4.2	45	C
	K155-D00xx	2.1	3.0	–	45	C
	K155-DE0xx	2.1	3.0	6.8	45	C

Note:

1. θ_{1/2} is the off axis angle from lamp centerline where the luminous intensity is 1/2 the on-axis value.

Part Numbering System

HLMP - x 1 xx - x x x xx

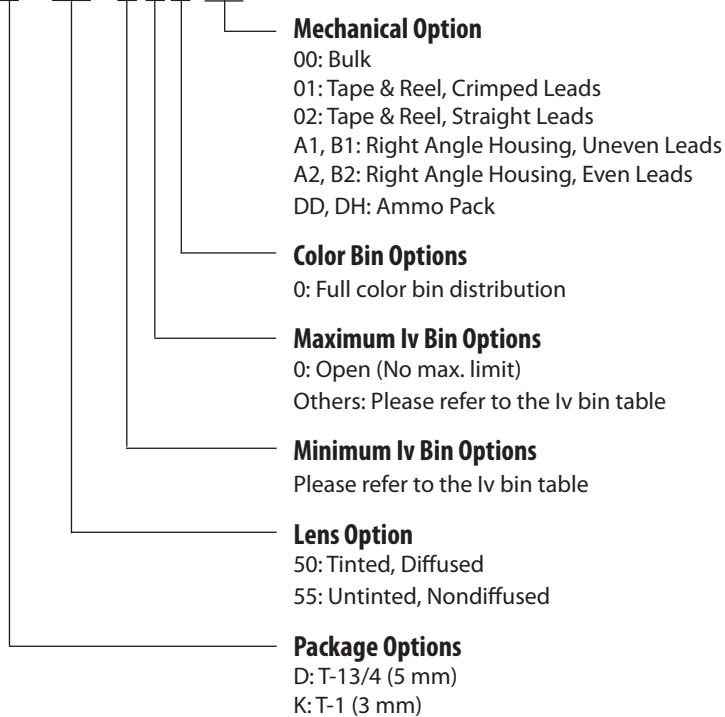

Absolute Maximum Ratings at $T_A = 25^\circ\text{C}$

Parameter	Value
Peak Forward Current ^[1]	300 mA
Average Forward Current	20 mA
DC Current ^[2]	30 mA
Power Dissipation	87 mW
Reverse Voltage ($I_R = 100 \mu\text{A}$)	5 V
Transient Forward Current (10 μs Pulse) ^[3]	500 mA
LED Junction Temperature	110°C
Operating Temperature Range	-20 to +100°C
Storage Temperature Range	-40 to +100°C

Notes:

1. Maximum I_{PEAK} at $f = 1 \text{ kHz}$, $DF = 6.7\%$.
2. Derate linearly as shown in Figure 4.
3. The transient peak current is the maximum non-recurring peak current the device can withstand without damaging the LED die and wire bonds. It is not recommended that the device be operated at peak currents beyond the Absolute Maximum Peak Forward Current.

Electrical/Optical Characteristics at $T_A = 25^\circ\text{C}$

Symbol	Description	Min.	Typ.	Max.	Unit	Test Condition
V_F	Forward Voltage		1.6	1.8	V	$I_F = 1 \text{ mA}$
V_R	Reverse Breakdown Voltage	5.0	15.0		V	$I_R = 100 \mu\text{A}$
λ_p	Peak Wavelength		645		nm	Measurement at Peak
λ_d	Dominant Wavelength		637		nm	Note 1
$\Delta\lambda^{1/2}$	Spectral Line Halfwidth		20		nm	Wavelength width at spectral distribution 1/2 power point.
τ_S	Speed of Response		30		ns	Exponential Time Constant, e^{-1}/T_S
C	Capacitance		30		pF	$V_F = 0$, $f = 1 \text{ MHz}$
$R\theta_{J-PIN}$	Thermal Resistance		260 ^[3] 210 ^[4] 290 ^[5]		$^\circ\text{C}/\text{W}$	Junction to Cathode Lead
η_V	Luminous Efficacy		80		lm/W	Note 2

Notes:

1. The dominant wavelength, λ_d , is derived from the CIE chromaticity diagram and represents the color of the device.
2. The radiant intensity, I_e , in watts per steradian, may be found from the equation $I_e = I_V/\eta_V$, where I_V is the luminous intensity in candelas and η_V is luminous efficacy in lumens/watt.
3. HLMP-D150.
4. HLMP-D155.
5. HLMP-K150/-K155.

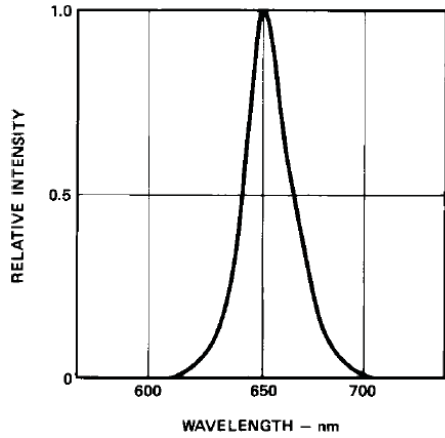

Figure 1. Relative intensity vs. wavelength.

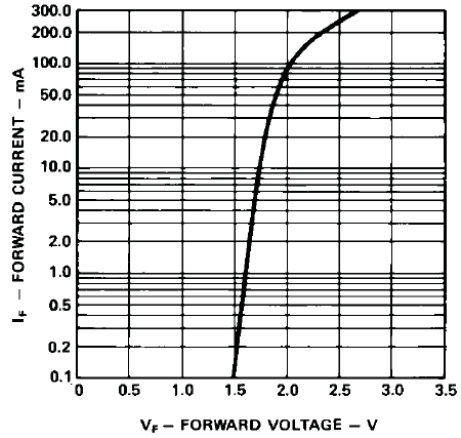

Figure 2. Forward current vs. forward voltage.

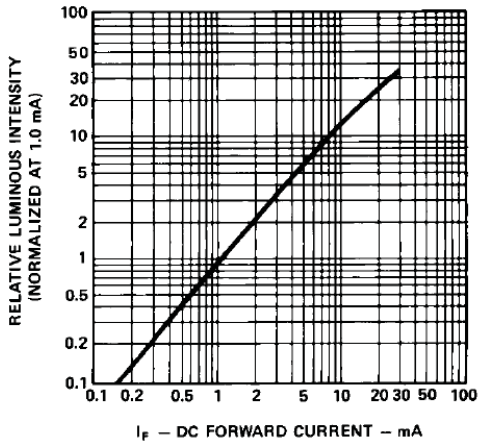

Figure 3. Relative luminous intensity vs. dc forward current.

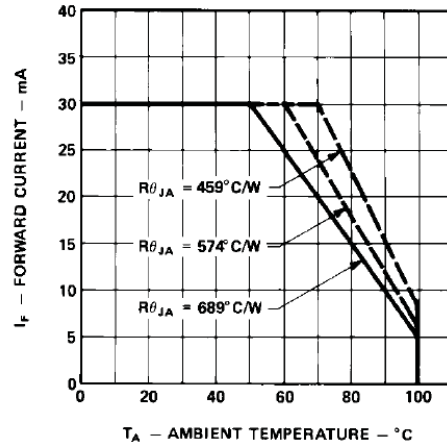

Figure 4. Maximum forward dc current vs. ambient temperature. Derating based on $T_{J \text{ Max.}} = 110^\circ\text{C}$.

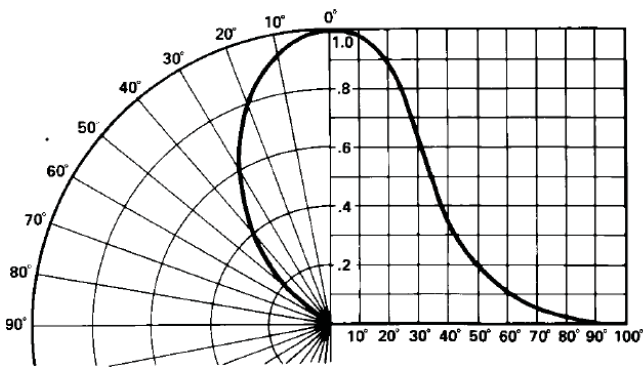

Figure 5. Relative luminous intensity vs. angular displacement. HLMP-D150.

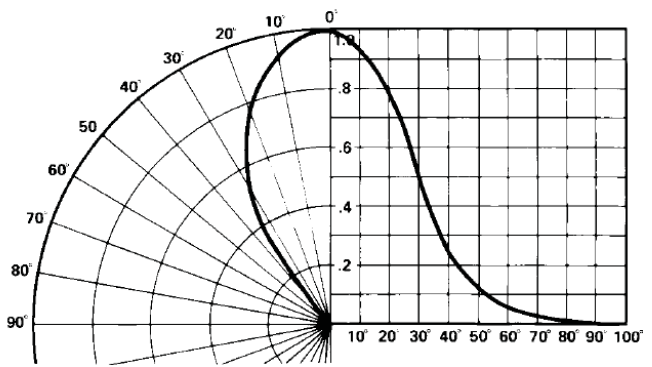

Figure 6. Relative luminous intensity vs. angular displacement. HLMP-K150.

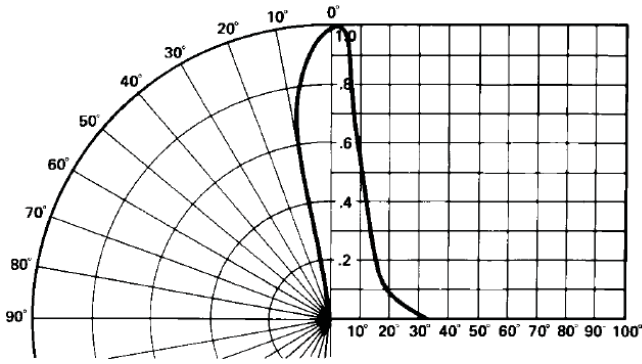

Figure 7. Relative luminous intensity vs. angular displacement.
HLMP-D155.

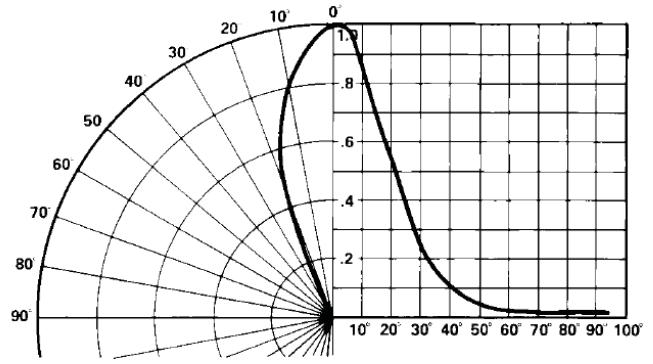

Figure 8. Relative luminous intensity vs. angular displacement.
HLMP-K155.

Intensity Bin Limits

Color	Bin	Intensity Range (mcd)	
		Min.	Max.
Red	C	1.5	2.4
	D	2.4	3.8
	E	3.8	6.1
	F	6.1	9.7
	G	9.7	15.5
	H	15.5	24.8
	I	24.8	39.6
	J	39.6	63.4
	K	63.4	101.5
	L	101.5	162.4
	M	162.4	234.6
	N	234.6	340.0
	O	340.0	540.0
	P	540.0	850.0
	Q	850.0	1200.0
	R	1200.0	1700.0
	S	1700.0	2400.0
	T	2400.0	3400.0
	U	3400.0	4900.0
	V	4900.0	7100.0
W	7100.0	10200.0	
X	10200.0	14800.0	
Y	14800.0	21400.0	
Z	21400.0	30900.0	

Note: Maximum tolerance for each bin limit is $\pm 18\%$.

Mechanical Option Matrix

Mechanical Option Code	Definition
00	Bulk Packaging, minimum increment 500 pcs/bag
01	Tape & Reel, crimped leads, minimum increment 1300 pcs for T-1 ^{3/4} , 1800 pcs for T-1
02	Tape & Reel, straight leads, minimum increment 1300 pcs for T-1 ^{3/4} , 1800 pcs for T-1
A1	T-1, Right Angle Housing, uneven leads, minimum increment 500 pcs/bag
A2	T-1, Right Angle Housing, even leads, minimum increment 500 pcs/bag
B1	T-1 ^{3/4} , Right Angle Housing, uneven leads, minimum increment 500 pcs/bag
B2	T-1 ^{3/4} , Right Angle Housing, even leads, minimum increment 500 pcs/bag
DD	Ammo Pack, straight leads with minimum 2K increment
DH	Ammo Pack, straight leads with minimum 2K increment

Note:

All categories are established for classification of products. Products may not be available in all categories. Please contact your local Avago representative for further clarification/information.

Precautions:

Lead Forming:

- The leads of an LED lamp may be preformed or cut to length prior to insertion and soldering on PC board.
- For better control, it is recommended to use proper tool to precisely form and cut the leads to applicable length rather than doing it manually.
- If manual lead cutting is necessary, cut the leads after the soldering process. The solder connection forms a mechanical ground which prevents mechanical stress due to lead cutting from traveling into LED package. This is highly recommended for hand solder operation, as the excess lead length also acts as small heat sink.

Soldering and Handling:

- Care must be taken during PCB assembly and soldering process to prevent damage to the LED component.
- LED component may be effectively hand soldered to PCB. However, it is only recommended under unavoidable circumstances such as rework. The closest manual soldering distance of the soldering heat source (soldering iron's tip) to the body is 1.59mm. Soldering the LED using soldering iron tip closer than 1.59mm might damage the LED.

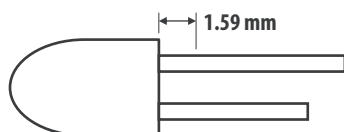

- ESD precaution must be properly applied on the soldering station and personnel to prevent ESD damage to the LED component that is ESD sensitive. Do refer to Avago application note AN 1142 for details. The soldering iron used should have grounded tip to ensure electrostatic charge is properly grounded.
- Recommended soldering condition:

	Wave Soldering ^{[1],[2]}	Manual Solder Dipping
Pre-heat Temperature	105°C Max.	–
Pre-heat Time	60 sec Max.	–
Peak Temperature	250°C Max.	260°C Max.
Dwell Time	3 sec Max.	5 sec Max.

Note:

1. Above conditions refers to measurement with thermocouple mounted at the bottom of PCB.
2. It is recommended to use only bottom preheaters in order to reduce thermal stress experienced by LED.

- Wave soldering parameters must be set and maintained according to the recommended temperature and dwell time. Customer is advised to perform daily check on the soldering profile to ensure that it is always conforming to recommended soldering conditions.

Note:

1. PCB with different size and design (component density) will have different heat mass (heat capacity). This might cause a change in temperature experienced by the board if same wave soldering setting is used. So, it is recommended to re-calibrate the soldering profile again before loading a new type of PCB.
 2. Customer is advised to take extra precaution during wave soldering to ensure that the maximum wave temperature does not exceed 250°C and the solder contact time does not exceeding 3sec. Over-stressing the LED during soldering process might cause premature failure to the LED due to delamination.
- Any alignment fixture that is being applied during wave soldering should be loosely fitted and should not apply weight or force on LED. Non metal material is recommended as it will absorb less heat during wave soldering process.
 - At elevated temperature, LED is more susceptible to mechanical stress. Therefore, PCB must allowed to cool down to room temperature prior to handling, which includes removal of alignment fixture or pallet.
 - If PCB board contains both through hole (TH) LED and other surface mount components, it is recommended that surface mount components be soldered on the top side of the PCB. If surface mount need to be on the bottom side, these components should be soldered using reflow soldering prior to insertion the TH LED.
 - Recommended PC board plated through holes (PTH) size for LED component leads.

LED Component Lead Size	Diagonal	Plated Through Hole Diameter
0.45 x 0.45 mm (0.018 x 0.018 inch)	0.636 mm (0.025 inch)	0.98 to 1.08 mm (0.039 to 0.043 inch)
0.50 x 0.50 mm (0.020 x 0.020 inch)	0.707 mm (0.028 inch)	1.05 to 1.15 mm (0.041 to 0.045 inch)

- Over-sizing the PTH can lead to twisted LED after clinching. On the other hand under sizing the PTH can cause difficulty inserting the TH LED.

Refer to application note AN5334 for more information about soldering and handling of TH LED lamps.

Example of Wave Soldering Temperature Profile for TH LED

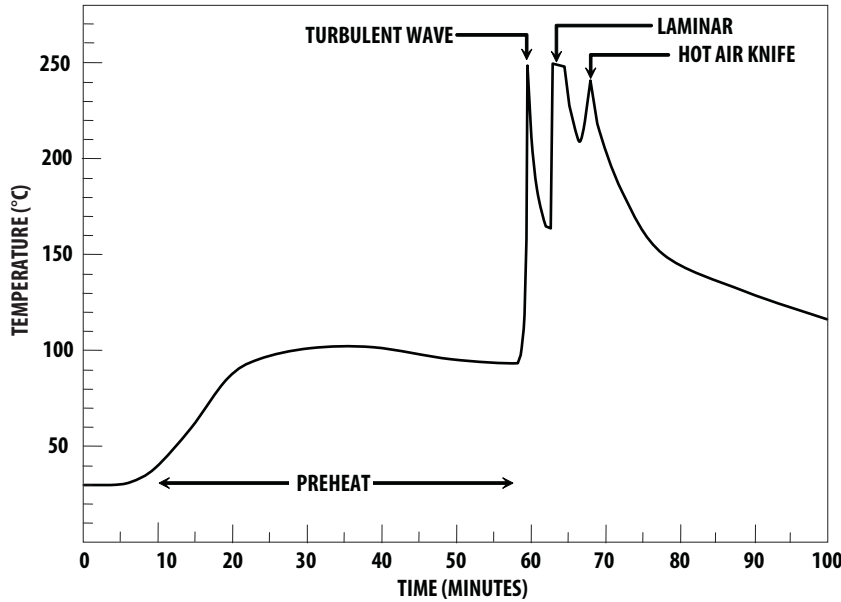

Recommended solder:
 Sn63 (Leaded solder alloy)
 SAC305 (Lead free solder alloy)

Flux: Rosin flux

Solder bath temperature:
 245°C ± 5°C (maximum peak temperature = 250°C)

Dwell time: 1.5 sec – 3.0 sec (maximum = 3sec)

Note: Allow for board to be sufficiently cooled to room temperature before exerting mechanical force.

Recommended solder:
 Sn63 (Leaded solder alloy)
 SAC305 (Lead free solder alloy)

Flux: Rosin flux













Solder bath temperature:
 245°C ± 5°C (maximum peak temperature = 250°C)

Dwell time: 1.5 sec – 3.0 sec (maximum = 3sec)

Note: Allow for board to be sufficiently cooled to room temperature before exerting mechanical force.

Packaging Label:

(i) Avago Mother Label: (Available on packaging box of ammo pack and shipping box)

 TECHNOLOGIES	
(1P) Item: Part Number	STANDARD LABEL LS0002
	RoHS Compliant
(1T) Lot: Lot Number	e3 max temp 250C
	(Q) QTY: Quantity
LPN:	
	CAT: Intensity Bin
(9D)MFG Date: Manufacturing Date	
	BIN: Color Bin
<hr/>	
(P) Customer Item:	
	
(V) Vendor ID:	(9D) Date Code: Date Code
	
<hr/>	
DeptID:	Made In: Country of Origin
	

(ii) Avago Baby Label (Only available on bulk packaging)

 Lamps Baby Label		RoHS Compliant e3 max temp 250C
(1P) PART #: Part Number 		
(1T) LOT #: Lot Number 		
(9D)MFG DATE: Manufacturing Date 	QUANTITY: Packing Quantity 	
C/O: Country of Origin		
Customer P/N: 	CAT: Intensity Bin 	
Supplier Code: 	BIN: Color Bin 	
	DATECODE: Date Code 	

For product information and a complete list of distributors, please go to our web site: www.avagotech.com

Avago, Avago Technologies, and the A logo are trademarks of Avago Technologies in the United States and other countries. Data subject to change. Copyright © 2005-2010 Avago Technologies. All rights reserved. Obsoletes 5898-4249EN AV02-1562EN - March 24, 2010





Компания «ЭлектроПласт» предлагает заключение долгосрочных отношений при поставках импортных электронных компонентов на взаимовыгодных условиях!

Наши преимущества:

- Оперативные поставки широкого спектра электронных компонентов отечественного и импортного производства напрямую от производителей и с крупнейших мировых складов;
- Поставка более 17-ти миллионов наименований электронных компонентов;
- Поставка сложных, дефицитных, либо снятых с производства позиций;
- Оперативные сроки поставки под заказ (от 5 рабочих дней);
- Экспресс доставка в любую точку России;
- Техническая поддержка проекта, помощь в подборе аналогов, поставка прототипов;
- Система менеджмента качества сертифицирована по Международному стандарту ISO 9001;
- Лицензия ФСБ на осуществление работ с использованием сведений, составляющих государственную тайну;
- Поставка специализированных компонентов (Xilinx, Altera, Analog Devices, Intersil, Interpoint, Microsemi, Aeroflex, Peregrine, Syfer, Eurofarad, Texas Instrument, Miteq, Cobham, E2V, MA-COM, Hittite, Mini-Circuits, General Dynamics и др.);

Помимо этого, одним из направлений компании «ЭлектроПласт» является направление «Источники питания». Мы предлагаем Вам помощь Конструкторского отдела:

- Подбор оптимального решения, техническое обоснование при выборе компонента;
- Подбор аналогов;
- Консультации по применению компонента;
- Поставка образцов и прототипов;
- Техническая поддержка проекта;
- Защита от снятия компонента с производства.



Как с нами связаться

Телефон: 8 (812) 309 58 32 (многоканальный)

Факс: 8 (812) 320-02-42

Электронная почта: org@eplast1.ru

Адрес: 198099, г. Санкт-Петербург, ул. Калинина, дом 2, корпус 4, литера А.