

## IR2133/IR2135(J&S)&(PbF) IR2233/IR2235(J&S)&(PbF)

### 3-PHASE BRIDGE DRIVER

#### Features

- Floating channel designed for bootstrap operation  
Fully operational to +600V or +1200V  
Tolerant to negative transient voltage  
dV/dt immune
- Gate drive supply range from 10V/12V to 20V DC and  
up to 25V for transient
- Undervoltage lockout for all channels
- Over-current shut down turns off all six drivers
- Independent 3 half-bridge drivers
- Matched propagation delay for all channels
- 2.5V logic compatible
- Outputs out of phase with inputs
- All parts are also available LEAD-FREE

#### Description

The IR2133/IR2135/IR2233/IR2355 (J&S) are high voltage, high speed power MOSFET and IGBT driver with three independent high side and low side referenced output channels for 3-phase applications. Proprietary HVIC technology enables ruggedized monolithic construction. Logic inputs are compatible with CMOS or LSTTL outputs, down to 2.5V logic. An independent operational amplifier provides an analog feedback of bridge current via an external current sense resistor. A current trip function which terminates all six outputs can also be derived from this resistor. A shutdown function is available to terminate all six outputs. An open drain  $\overline{\text{FAULT}}$  signal is provided to indicate that an over-current or undervoltage shutdown has occurred. Fault conditions are cleared with the  $\overline{\text{FLT-CLR}}$  lead. The output drivers feature a high pulse current buffer stage designed for minimum driver cross-conduction. Propagation delays are matched to simplify use in high frequency applications. The floating channels can be used to drive N-channel power MOSFETs or IGBTs in the high side configuration which operates up to 600 volts or 1200 volts.

#### Product Summary

|                            |                      |
|----------------------------|----------------------|
| $V_{\text{OFFSET}}$        | 600V or 1200V max.   |
| $I_{\text{O}+/-}$          | 200 mA / 420 mA      |
| $V_{\text{OUT}}$           | 10 - 20V or 12 - 20V |
| $t_{\text{on/off}}$ (typ.) | 750/700 ns           |
| Deadtime (typ.)            | 250 ns               |

#### Packages



#### Typical Connection



# IR2133/IR2135/IR2233/IR2235(J&S)&(PbF)

International  
IR Rectifier

## Absolute Maximum Ratings

Absolute Maximum Ratings indicate sustained limits beyond which damage to the device may occur. All voltage parameters are absolute voltages referenced to COM. The Thermal Resistance and Power Dissipation ratings are measured under board mounted and still air conditions.

| Symbol               | Definition  | Min.                      | Max.  | Units |
|----------------------|---|---------------------------|---|-------|
| V <sub>B1,2,3</sub>  | High side floating supply voltage (IR2133/IR2135)<br>(IR2233/IR2235)  | -0.3                      | 625   | V     |
|                      |   | -0.3                      | 1225  |       |
| V <sub>S1,2,3</sub>  | High side floating supply offset voltage  | V <sub>B1,2,3</sub> - 25  | V <sub>B1,2,3</sub> + 0.3   |       |
| V <sub>HO1,2,3</sub> | High side floating output voltage   | V <sub>S1,2,3</sub> - 0.3 | V <sub>B1,2,3</sub> + 0.3   |       |
| V <sub>CC</sub>      | Fixed supply voltage  | -0.3                      | 25  |       |
| V <sub>SS</sub>      | Logic ground  | V <sub>CC</sub> - 25      | V <sub>CC</sub> + 0.3   |       |
| V <sub>LO1,2,3</sub> | Low side output voltage   | -0.3                      | V <sub>CC</sub> + 0.3   |       |
| V <sub>IN</sub>      | Logic input voltage ( $\overline{\text{HIN}}$ , $\overline{\text{LIN}}$ , ITRIP, SD & $\overline{\text{FLT-CLR}}$ ) | V <sub>SS</sub> - 0.3     | (V <sub>SS</sub> + 15) or<br>(V <sub>CC</sub> + 0.3)<br>whichever is<br>lower |       |
| V <sub>IN,AMP</sub>  | Op amp input voltage (CA+ & CA-)  | V <sub>SS</sub> - 0.3     | V <sub>CC</sub> + 0.3   |       |
| V <sub>OUT,AMP</sub> | Op amp output voltage (CAO)   | V <sub>SS</sub> - 0.3     | V <sub>CC</sub> + 0.3   |       |
| V <sub>FLT</sub>     | FAULT output voltage  | V <sub>SS</sub> - 0.3     | V <sub>CC</sub> + 0.3   |       |
| dV <sub>S</sub> /dt  | Allowable offset supply voltage transient   | —                         | 50  | V/ns  |
| P <sub>D</sub>       | Package power dissipation @ T <sub>A</sub> ≤ 25°C (28 Lead PDIP)<br>(28 Lead SOIC)<br>(44 lead PLCC)                | —                         | 1.5   | W     |
|                      |   | —                         | 1.6   |       |
|                      |   | —                         | 2.0   |       |
| R <sub>thJA</sub>    | Thermal resistance, junction to ambient (28 Lead PDIP)<br>(28 Lead SOIC)<br>(44 lead PLCC)                          | —                         | 83  | °C/W  |
|                      |   | —                         | 78  |       |
|                      |   | —                         | 63  |       |
| T <sub>J</sub>       | Junction temperature  | —                         | 125   | °C    |
| T <sub>S</sub>       | Storage temperature   | -55                       | 150   |       |
| T <sub>L</sub>       | Lead temperature (soldering, 10 seconds)  | —                         | 300   |       |

## Recommended Operating Conditions

The input/output logic timing diagram is shown in figure 1. For proper operation the device should be used within the recommended conditions. All voltage parameters are absolute voltages referenced to COM. The VS offset rating is tested with all supplies biased at 15V differential.

| Symbol               | Parameter Definition  | Min.                        | Max.                     | Units |
|----------------------|---|-----------------------------|--------------------------|-------|
| V <sub>B1,2,3</sub>  | High side floating supply voltage   | V <sub>S1,2,3</sub> + 10/12 | V <sub>S1,2,3</sub> + 20 | V     |
| V <sub>S1,2,3</sub>  | High side floating supply offset voltage (IR2133/IR2135)<br>(IR2233/IR2235)   | Note 1                      | 600                      |       |
|                      |   | Note 1                      | 1200                     |       |
| V <sub>HO1,2,3</sub> | High side floating output voltage   | V <sub>S1,2,3</sub>         | V <sub>B1,2,3</sub>      |       |
| V <sub>CC</sub>      | Fixed supply voltage  | 10 or 12                    | 20                       |       |
| V <sub>SS</sub>      | Low side driver return  | -5                          | 5                        |       |
| V <sub>LO1,2,3</sub> | Low side output voltage   | 0                           | V <sub>CC</sub>          |       |
| V <sub>IN</sub>      | Logic input voltage ( $\overline{\text{HIN}}$ , $\overline{\text{LIN}}$ , ITRIP, SD & $\overline{\text{FLT-CLR}}$ ) | V <sub>SS</sub>             | V <sub>SS</sub> + 5      |       |
| V <sub>IN,AMP</sub>  | Op amp input voltage (CA+ & CA-)  | V <sub>SS</sub>             | V <sub>SS</sub> + 5      |       |
| V <sub>OUT,AMP</sub> | Op amp output voltage (CAO)   | V <sub>SS</sub>             | V <sub>SS</sub> + 5      |       |
| V <sub>FLT</sub>     | FAULT output voltage  | V <sub>SS</sub>             | V <sub>CC</sub>          |       |

**Note 1:** Logic operational for V<sub>S</sub> of COM - 5V to COM + 600V/1200V. Logic state held for V<sub>S</sub> of COM -5V to COM -V<sub>BS</sub>. (Please refer to the Design Tip DT97-3 for more details).

**Note 2:** All input pins, op amp input and output pins are internally clamped with a 5.2V zener diode.

### Dynamic Electrical Characteristics

V<sub>BIAS</sub> (V<sub>CC</sub>, V<sub>BS1,2,3</sub>) = 15V, V<sub>S1,2,3</sub> = V<sub>SS</sub>, T<sub>A</sub> = 25°C and C<sub>L</sub> = 1000 pF unless otherwise specified.

| Symbol              | Definition  | Min. | Typ. | Max. | Units | Test Conditions   |
|---------------------|---|------|------|------|-------|---|
| t <sub>on</sub>     | Turn-on propagation delay                                       | 500  | 750  | 1000 | ns    | V <sub>IN</sub> = 0 & 5V<br>V <sub>S1,2,3</sub> = 0 to 600V<br>or 1200V |
| t <sub>off</sub>    | Turn-off propagation delay                                      | 450  | 700  | 950  |       |   |
| t <sub>r</sub>      | Turn-on rise time   | —    | 90   | 150  |       |   |
| t <sub>f</sub>      | Turn-off fall time  | —    | 40   | 70   |       |   |
| t <sub>sd</sub>     | SD to output shutdown propagation delay                         | 500  | 750  | 1000 |       |   |
| t <sub>itrip</sub>  | ITRIP to output shutdown propagation delay                      | 600  | 850  | 1100 |       |   |
| t <sub>bl</sub>     | ITRIP blanking time   | —    | 400  | —    |       |   |
| t <sub>flt</sub>    | ITRIP to $\overline{\text{FAULT}}$ propagation delay            | 400  | 650  | 900  |       |   |
| t <sub>fil,in</sub> | Input filter time (HIN, LIN and SD)                             | —    | 310  | —    |       |   |
| t <sub>fltclr</sub> | FLT-CLR to $\overline{\text{FAULT}}$ clear time                 | 600  | 850  | 1100 |       |   |
| DT                  | Deadtime, LS turn-off to HS turn-on & HS turn-off to LS turn-on | 100  | 250  | 400  | V/μs  | V <sub>IN</sub> = 0 & 5V  |
| SR+                 | Amplifier slew rate (positive)                                  | 5    | 10   | —    |       |   |
| SR-                 | Amplifier slew rate (negative)                                  | 2    | 2.5  | —    |       |   |

NOTE: For high side PWM, HIN pulse width must be ≥ 1μ sec

### Static Electrical Characteristics

V<sub>BIAS</sub> (V<sub>CC</sub>, V<sub>BS1,2,3</sub>) = 15V unless otherwise specified and T<sub>A</sub> = 25°C. All static parameters other than IO and VO are referenced to V<sub>SS</sub> and are applicable to all six channels (HS<sub>1,2,3</sub> & LS<sub>1,2,3</sub>). The VO and IO parameters are referenced to COM and V<sub>S1,2,3</sub> and are applicable to the respective output leads: HO<sub>1,2,3</sub> or LO<sub>1,2,3</sub>.

| Symbol               | Definition   | Min. | Typ. | Max. | Units | Test Conditions                                  |
|----------------------|--|------|------|------|-------|--|
| V <sub>IH</sub>      | Logic "0" Input Voltage (OUT = LO)                               | 2.2  | —    | —    | V     |  |
| V <sub>IL</sub>      | Logic "1" Input Voltage (OUT = HI)                               | —    | —    | 0.8  |       |  |
| V <sub>FCLR,IH</sub> | Logic "0" Fault Clear Input Voltage                              | 2.2  | —    | —    |       |  |
| V <sub>FCLR,IL</sub> | Logic "1" Fault Clear Input Voltage                              | —    | —    | 0.8  |       |  |
| V <sub>SD,TH+</sub>  | SD Input Positive Going Threshold                                | 1.6  | 1.9  | 2.2  |       |  |
| V <sub>SD,TH-</sub>  | SD Input Negative Going Threshold                                | 1.4  | 1.7  | 2.0  |       |  |
| V <sub>IT,TH+</sub>  | ITRIP Input Positive Going Threshold                             | 470  | 570  | 670  | mV    |  |
| V <sub>IT,TH-</sub>  | ITRIP Input Negative Going Threshold                             | 360  | 460  | 560  |       |  |
| V <sub>OH</sub>      | High Level Output Voltage, V <sub>BIAS</sub> - V <sub>O</sub>    | —    | —    | 100  | mV    | V <sub>IN</sub> = 0V, I <sub>O</sub> = 0A        |
| V <sub>OL</sub>      | Low Level Output Voltage, V <sub>O</sub>                         | —    | —    | 100  |       | V <sub>IN</sub> = 5V, I <sub>O</sub> = 0A        |
| I <sub>LK</sub>      | Offset Supply Leakage Current (IR2133/IR2135)<br>(IR2233/IR2235) | —    | —    | 50   | μA    | V <sub>B1,2,3</sub> =V <sub>S1,2,3</sub> = 600V  |
|                      |  | —    | —    | 50   |       | V <sub>B1,2,3</sub> =V <sub>S1,2,3</sub> = 1200V |
| I <sub>QBS</sub>     | Quiescent V <sub>BS</sub> Supply Current                         | —    | 50   | 100  | mA    | V <sub>IN</sub> = 0V or 5V                       |
| I <sub>QCC</sub>     | Quiescent V <sub>CC</sub> Supply Current                         | —    | 4    | 8    |       | V <sub>IN</sub> = 0V or 5V                       |
| I <sub>IN+</sub>     | Logic "1" Input Bias Current (OUT = HI)                          | —    | 200  | 350  | μA    | V <sub>IN</sub> = 0V                             |
| I <sub>IN-</sub>     | Logic "0" Input Bias Current (OUT = LO)                          | —    | 100  | 250  |       | V <sub>IN</sub> = 5V                             |
| I <sub>SD+</sub>     | "High" Shutdown Bias Current                                     | —    | 30   | 100  | nA    | SD = 5V  |
| I <sub>SD-</sub>     | "Low" Shutdown Bias Current                                      | —    | —    | 100  |       | SD = 0V  |
| I <sub>ITRIP+</sub>  | "High" ITRIP Bias Current  | —    | 30   | 100  | μA    | I <sub>ITRIP</sub> = 5V                          |
| I <sub>ITRIP-</sub>  | "Low" ITRIP Bias Current   | —    | —    | 100  |       | I <sub>ITRIP</sub> = 0V                          |

## Static Electrical Characteristics — Continued

V<sub>BIAS</sub> (V<sub>CC</sub>, V<sub>BS1,2,3</sub>) = 15V unless otherwise specified and T<sub>A</sub> = 25°C. All static parameters other than IO and VO are referenced to V<sub>SS</sub> and are applicable to all six channels (H<sub>S1,2,3</sub> & L<sub>S1,2,3</sub>). The VO and IO parameters are referenced to COM and V<sub>S1,2,3</sub> and are applicable to the respective output leads: H<sub>O1,2,3</sub> or L<sub>O1,2,3</sub>.

| Symbol               | Parameter Definition  | Min.                | Typ. | Max. | Units | Test Conditions  |
|----------------------|---|---------------------|------|------|-------|--|
| I <sub>FLTCLR+</sub> | "High" Fault Clear Input Bias Current   | —                   | 200  | 350  | μA    | $\overline{\text{FLT-CLR}} = 0\text{V}$                    |
| I <sub>FLTCLR-</sub> | "Low" Fault Clear Input Bias Current  | —                   | 100  | 250  |       | $\overline{\text{FLT-CLR}} = 5\text{V}$                    |
| V <sub>BSUV+</sub>   | V <sub>BS</sub> Supply Undervoltage Positive Going Threshold<br>(for IR2133/IR2233) | 7.6                 | 8.6  | 9.6  | V     |  |
|                      |   | (for IR2135/IR2235) | 9.2  | 10.4 |       |  |
| V <sub>BSUV-</sub>   | V <sub>BS</sub> Supply Undervoltage Negative Going Threshold<br>(for IR2133/IR2233) | 7.2                 | 8.2  | 9.2  |       |  |
|                      |   | (for IR2135/IR2235) | 8.3  | 9.4  |       |  |
| V <sub>BSUVH</sub>   | V <sub>BS</sub> Supply Undervoltage Lockout Hysteresis<br>(for IR2133/IR2233)       | —                   | 0.4  | —    |       |  |
|                      |   | (for IR2135/IR2235) | —    | 1    |       |  |
| V <sub>CCUV+</sub>   | V <sub>CC</sub> Supply Undervoltage Positive Going Threshold<br>(for IR2133/IR2233) | 7.6                 | 8.6  | 9.6  |       |  |
|                      |   | (for IR2135/IR2235) | 9.2  | 10.4 |       |  |
| V <sub>CCUV-</sub>   | V <sub>CC</sub> Supply Undervoltage Negative Going Threshold<br>(for IR2133/IR2233) | 7.2                 | 8.2  | 9.2  |       |  |
|                      |   | (for IR2135/IR2235) | 8.3  | 9.4  |       |  |
| V <sub>CCUVH</sub>   | V <sub>CC</sub> Supply Undervoltage Lockout Hysteresis<br>(for IR2133/IR2233)       | —                   | 0.4  | —    |       |  |
|                      |   | (for IR2135/IR2235) | —    | 1    |       |  |
| R <sub>on,FLT</sub>  | FAULT- Low On Resistance  | —                   | 70   | 100  | Ω     |  |
| I <sub>o+</sub>      | Output High Short Circuit Pulsed Current  | 200                 | 250  | —    | mA    | V <sub>OUT</sub> = 0V, V <sub>IN</sub> = 0V<br>PW ≤ 10 μs  |
| I <sub>o-</sub>      | Output Low Short Circuit Pulsed Current   | 420                 | 500  | —    |       | V <sub>OUT</sub> = 15V, V <sub>IN</sub> = 5V<br>PW ≤ 10 μs |
| V <sub>OS</sub>      | Amplifier Input Offset Voltage  | —                   | 0    | 30   | mV    | CA+ = 0.2V, CA- = CAO                                      |
| I <sub>IN,AMP</sub>  | Amplifier Input Bias Current  | —                   | —    | 4    | nA    | CA+ = CA- = 2.5V   |
| CMRR                 | Amplifier Common Mode Rejection Ratio   | 50                  | 70   | —    | dB    | CA+ = 0.1V & 5V, CA- = CAO                                 |
| PSRR                 | Amplifier Power Supply Rejection Ratio  | 50                  | 70   | —    |       | CA+ = 0.2V, CA- = CAO<br>V <sub>CC</sub> = 10V & 20V       |
| V <sub>OH,Amp</sub>  | Amplifier High Level Output Voltage   | 5                   | 5.2  | 5.4  | V     | CA+ = 1V, CA- = 0V   |
| V <sub>OL,Amp</sub>  | Amplifier Low Level Output Voltage  | —                   | —    | 20   | mV    | CA+ = 0V, CA- = 1V   |
| I <sub>SRC,Amp</sub> | Amplifier Output Source Current   | 4                   | 7    | —    | mA    | CA+ = 1V, CA- = 0V, CAO = 4V                               |
| I <sub>SNK,Amp</sub> | Amplifier Output Sink Current   | 0.5                 | 1    | —    |       | CA+ = 0V, CA- = 1V, CAO = 2V                               |
| I <sub>o+,Amp</sub>  | Amplifier Output High Short Circuit Current   | —                   | 10   | —    |       | CA+ = 5V, CA- = 0V, CAO = 0V                               |
| I <sub>o-,Amp</sub>  | Amplifier Output Low Short Circuit Current  | —                   | 4    | —    |       | CA+ = 0V, CA- = 5V, CAO = 5V                               |

**Functional Block Diagram**

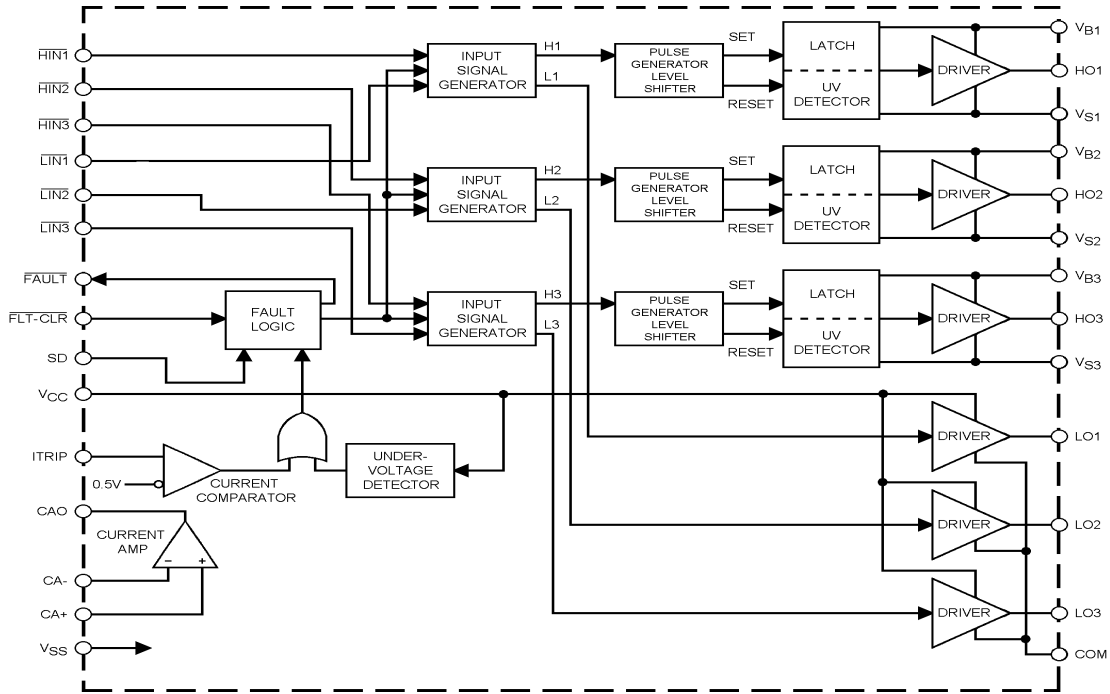

**Lead Definitions**

| Symbol                          | Lead Description  |
|---------------------------------|---|
| $\overline{\text{HIN}}_{1,2,3}$ | Logic inputs for high side gate driver outputs (HO1,2,3), out of phase.                 |
| $\overline{\text{LIN}}_{1,2,3}$ | Logic inputs for low side gate driver outputs (LO1,2,3), out of phase.                  |
| $\overline{\text{FAULT}}$       | Indicates over-current or undervoltage lockout (low side) has occurred, negative logic. |
| Vcc                             | Logic and low side fixed supply.  |
| ITRIP                           | Input for over-current shut down.   |
| $\overline{\text{FLT-CLR}}$     | Logic input for fault clear, negative logic.  |
| SD                              | Logic input for shut down.  |
| CAO                             | Output of current amplifier.  |
| CA-                             | Negative input of current amplifier.  |
| CA+                             | Positive input of current amplifier.  |
| Vss                             | Logic ground.   |
| COM                             | Low side return.  |
| $V_{B1,2,3}$                    | High side floating supplies.  |
| HO1,2,3                         | High side gate drive outputs.   |
| $V_{S1,2,3}$                    | High side floating supply returns.  |
| LO1,2,3                         | Low side gate drive outputs   |

# IR2133/IR2135/IR2233/IR2235(J&S)&(PbF)

International  
**IR** Rectifier

## Lead Assignments

|  |  |   |
|--|--|---|
|  <p>28 Lead DIP</p> |  <p>44 Lead PLCC w/o 12 Leads</p> |  <p>28 Lead SOIC (Wide Body)</p> |
| <p><b>IR2133</b><br/><b>IR2135</b></p>   | <p><b>IR2133J</b><br/><b>IR2135J</b><br/><b>IR2233J</b><br/><b>IR2235J</b></p>                                     | <p><b>IR2133S</b><br/><b>IR2135S</b><br/><b>IR2233S</b><br/><b>IR2235S</b></p>                                      |
| <p><b>Part Number</b></p>  |  |   |



Figure 1. Input/Output Timing Diagram



Figure 2. Switching Time Waveform Definitions

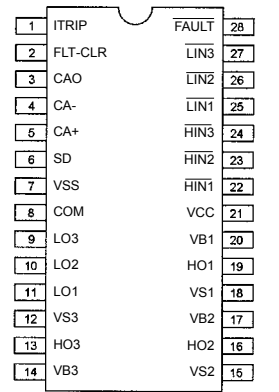
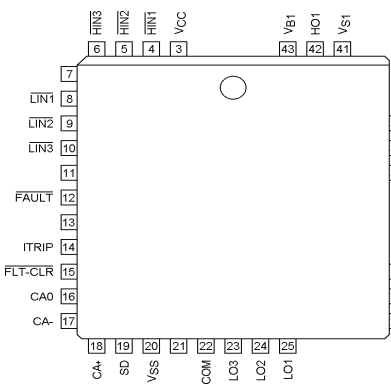
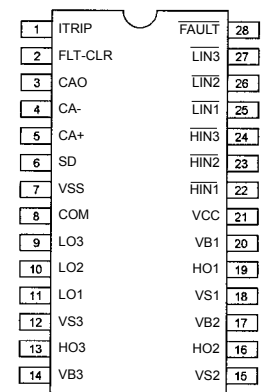

Figure 3. Deadtime Waveform Definitions



Figure 4. Overcurrent Shutdown Waveform

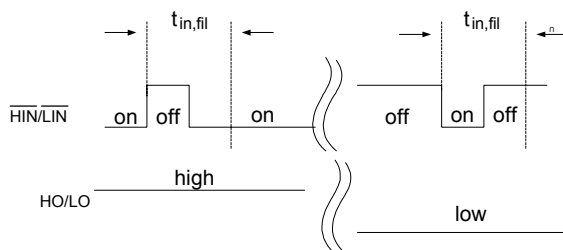

Figure 4.5. Input Filter Function

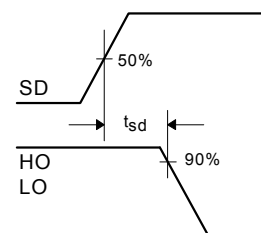

Figure 5. Shutdown Waveform Definitions



Figure 6A. Turn-On Time vs. Temperature

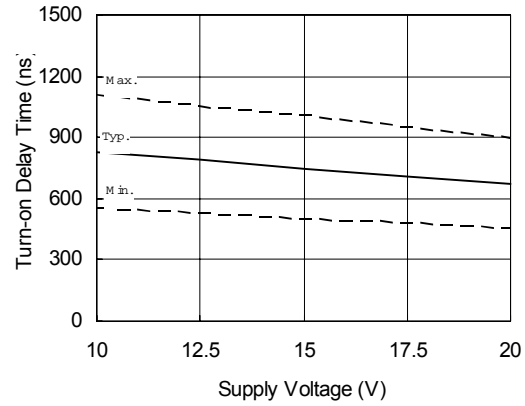

Figure 6B. Turn-On Time vs. Voltage



Figure 6C. Turn-On Time vs. Input Voltage



Figure 7A. Turn-Off Time vs. Temperature

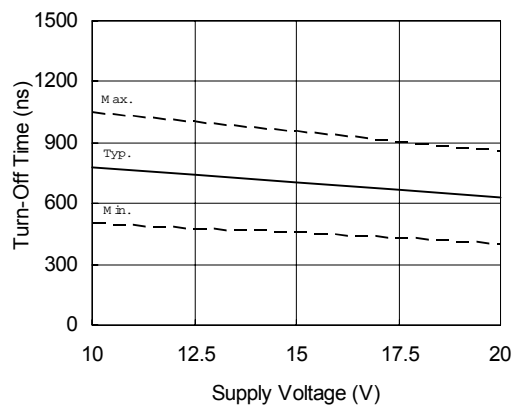

Figure 7B. Turn-Off Time vs. Voltage

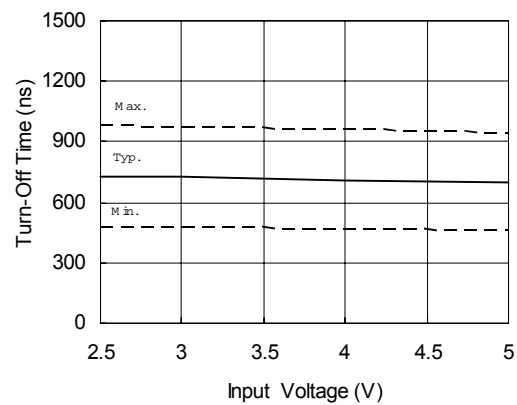

Figure 7C. Turn-Off Time vs. Input Voltage





**Figure 8A. Turn-On Rise Time vs. Temperature**



**Figure 8B. Turn-On Rise Time vs. Voltage**



**Figure 9A. Turn-Off Fall Time vs. Temperature**



**Figure 9B. Turn-Off Fall Time vs. Voltage**



**Figure 10A. SD to Output shutdown Time vs. Temperature**



**Figure 10B. SD to Output shutdown Time vs. Voltage**



Figure 11A. ITRIP to FAULT Time vs. Temperature

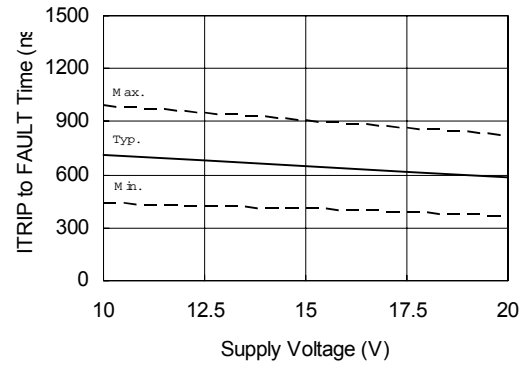

Figure 11B. ITRIP to FAULT Time vs. Voltage



Figure 12A. ITRIP to output shutdown Time vs. Temperature

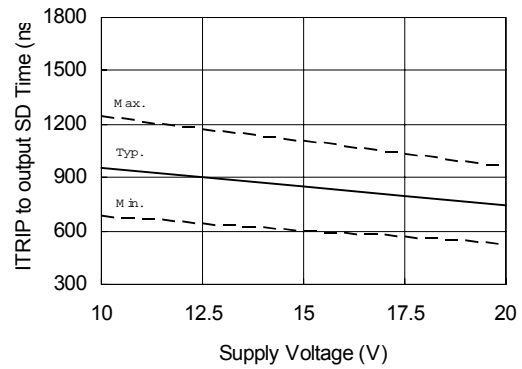

Figure 12B. ITRIP to output shutdown Time vs. Voltage



Figure 13A. FLT-CLR to FAULT clear Time vs. Temperature

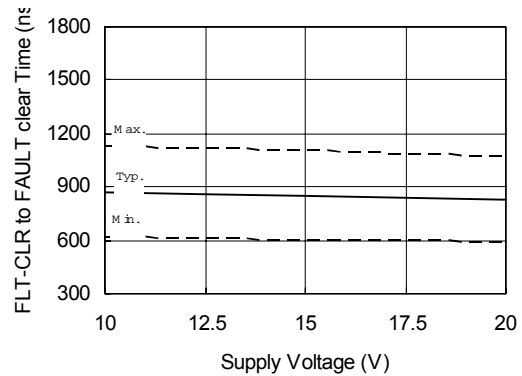

Figure 13B. FLT-CLR to FAULT clear Time vs. Voltage



**Figure 14A. Deadtime vs. Temperature**



**Figure 14B. Deadtime vs. Voltage**



**Figure 15A. Amplifier slew rate (+) vs. Temperature**



**Figure 15B. Amplifier slew rate (+) vs. Voltage**



**Figure 16A. Amplifier slew rate (-) vs. Temperature**

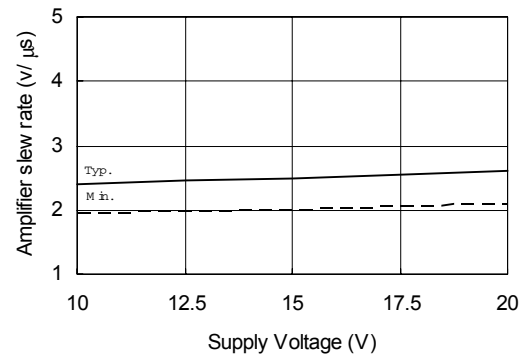

**Figure 16B. Amplifier slew rate (-) vs. Voltage**



Figure 17A. Logic "0" Input Voltage (OUT=LO), Fault Clear Voltage vs. Temperature



Figure 17B. Logic "0" Input Voltage (OUT=LO), Fault Clear Voltage vs. Voltage



Figure 18A. Logic "1" Input (OUT=HI), Fault Clear Input Voltage vs. Temperature



Figure 18B. Logic "1" Input (OUT=HI), Fault Clear Input Voltage vs. Voltage



Figure 21A. SD Input TH(+) vs. Temperature



Figure 21B. SD Input TH(+) vs. Voltage



Figure 22A. SD Input TH(-) vs. Temperature



Figure 22B. SD Input TH(-) vs. Voltage



Figure 23A. I<sub>TRIP</sub> Input TH(+) vs. Temperature



Figure 23B. I<sub>TRIP</sub> Input TH(+) vs. Voltage



Figure 24A. I<sub>TRIP</sub> Input TH(-) vs. Temperature



Figure 24B. I<sub>TRIP</sub> Input TH(-) vs. Voltage

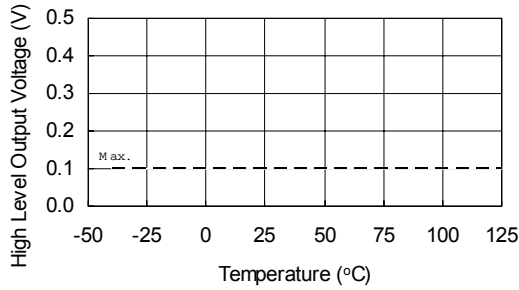

Figure 25A. High Level Output vs. Temperature



Figure 25B. High Level Output vs. Voltage



Figure 26A. Low Level Output vs. Temperature



Figure 26B. Low Level Output vs. Voltage

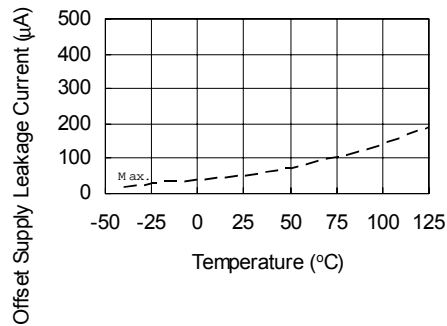

Figure 27A. Offset Supply Leakage Current vs. Temperature



Figure 27B. Offset Supply Leakage Current vs. Voltage



**Figure 28A.  $V_{BS}$  Supply Current vs. Temperature**



**Figure 28B.  $V_{BS}$  Supply Current vs. Voltage**



**Figure 29A.  $V_{CC}$  Supply Current vs. Temperature**



**Figure 29B.  $V_{CC}$  Supply Current vs. Voltage**



**Figure 30A. Logic "1" Input Bias Current vs. Temperature**



**Figure 30B. Logic "1" Input Bias Current vs. Voltage**



Figure 31A. Logic "0" Input Bais Current vs. Temperature



Figure 31B. Logic "0" Input Bais Current vs. Supply Voltage

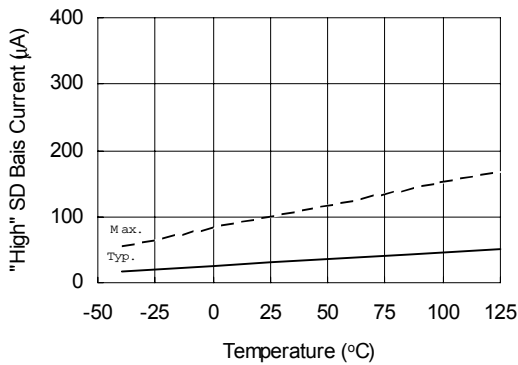

Figure 32A. "High" Shutdown Bais Current vs. Temperature

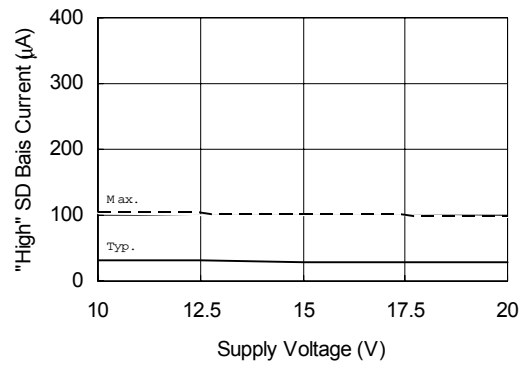

Figure 32B. "High" Shutdown Bais Current vs. Supply Voltage

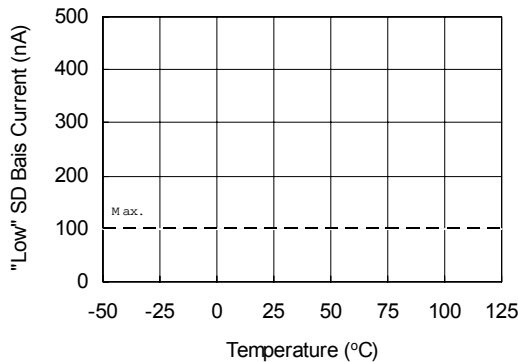

Figure 33A. "Low" Shutdown Bais Current vs. Temperature

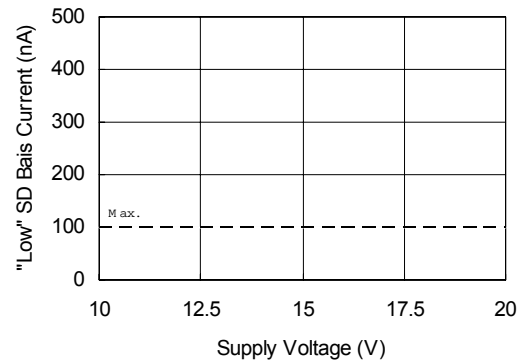

Figure 33B. "Low" Shutdown Bais Current vs. Supply Voltage





**Figure 34A. "High"  $I_{TRIP}$  Bias Current vs. Temperature**



**Figure 34B. "High"  $I_{TRIP}$  Bias Current vs. Supply Voltage**



**Figure 35A. "Low"  $I_{TRIP}$  Bias Current vs. Temperature**



**Figure 35B. "Low"  $I_{TRIP}$  Bias Current vs. Supply Voltage**



**Figure 36A. "High" Fault Clear Input Bias Current vs. Temperature**



**Figure 36B. "High" Fault Clear Input Bias Current vs. Supply voltage**



Figure 37A. "Low" Fault Clear Input Bias Current vs. Temperature



Figure 37B. "Low" Fault Clear Input Bias Current vs. Supply Voltage

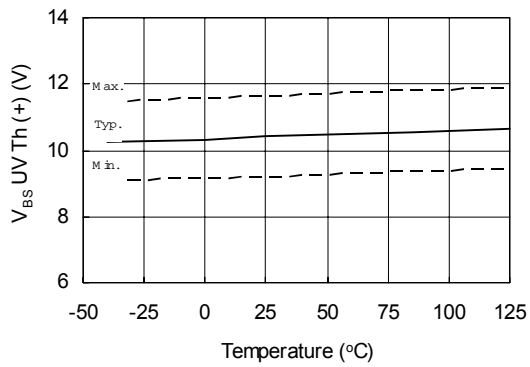

Figure 38A. IR2135/IR2235  $V_{BS}$  Undervoltage Threshold (+) vs. Temperature



Figure 38B. IR2133/IR2233  $V_{BS}$  Undervoltage Threshold (+) vs. Temperature



Figure 39A. IR2135/IR2235  $V_{BS}$  Undervoltage Threshold (-) vs. Temperature



Figure 39B. IR2133/IR2233  $V_{BS}$  Undervoltage Threshold (-) vs. Temperature



**Figure 40A. IR2135/IR2235  $V_{cc}$  Undervoltage Threshold (+) vs. Temperature**



**Figure 40B. IR2133/IR2233  $V_{cc}$  Undervoltage Threshold (+) vs. Temperature**



**Figure 41A. IR2135/IR2235  $V_{cc}$  Undervoltage Threshold (-) vs. Temperature**



**Figure 41B. IR2133/IR2233  $V_{cc}$  Undervoltage Threshold (-) vs. Temperature**



**Figure 42A. FAULT- Low On Resistance vs. Temperature**



**Figure 42B. FAULT- Low On Resistance vs. Supply Voltage**



Figure 43A. Output Source Current vs. Temperature



Figure 43B. Output Source Current vs. Supply Voltage



Figure 44A. Output Sink Current vs. Temperature



Figure 44B. Output Sink Current vs. Supply Voltage



Figure 45A. Amplifier Input Offset Voltage vs. Temperature



Figure 45B. Amplifier Input Offset Voltage vs. Supply Voltage



**Figure 46A. Amplifier Common Mode Rejection Ratio vs. Temperature**



**Figure 46B. Amplifier Common Mode Rejection Ratio vs. Supply Voltage**



**Figure 47A. Amplifier Power Supply Rejection Ratio vs. Temperature**



**Figure 47B. Amplifier Power Supply Rejection Ratio vs. Supply Voltage**



**Figure 48. Amplifier High Level Output Voltage vs. Supply Voltage**



**Figure 49. Amplifier Low Level Output Voltage vs. Supply Voltage**



Figure 50. Amplifier Output Source Current vs. Supply Voltage



Figure 51. Amplifier Output Sink Current vs. Supply Voltage



Figure 52. Amplifier Output High Short Circuit Current vs. Supply Voltage



Figure 53. Amplifier Output Low Short Circuit Current vs. Supply Voltage



Figure 7. IR2133J Junction Temperature vs Frequency Driving (IRGPC20KD2) Rgate = 5.1Ω @ Vcc = 15V



Figure 8. IR2133J Junction Temperature vs Frequency Driving (IRGPC30KD2) Rgate = 5.1Ω @ Vcc = 15V



Figure 9. IR2133J Junction Temperature vs Frequency Driving (IRGPC40KD2) Rgate = 5.1Ω @ Vcc = 15V



Figure 10. IR2133J Junction Temperature vs Frequency Driving (IRGPC50KD2) Rgate = 5.1Ω @ Vcc = 15V

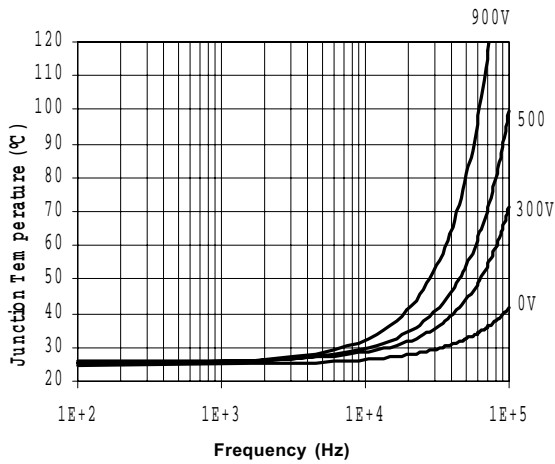

Figure 11. IR2233J Junction Temperature vs Frequency Driving (IRG4PH30KD) Rgate = 20Ω @ Vcc = 15V



Figure 12. IR2233J Junction Temperature vs Frequency Driving (IRG4PH40KD) Rgate = 15Ω @ Vcc = 15V



Figure 13. IR2233J Junction Temperature vs Frequency Driving (IRG4PH50KD) Rgate = 10Ω @ Vcc = 15V



Figure 14. IR2233J Junction Temperature vs Frequency Driving (IRG4ZH71KD) Rgate = 5Ω @ Vcc = 15V



**Package Dimensions**

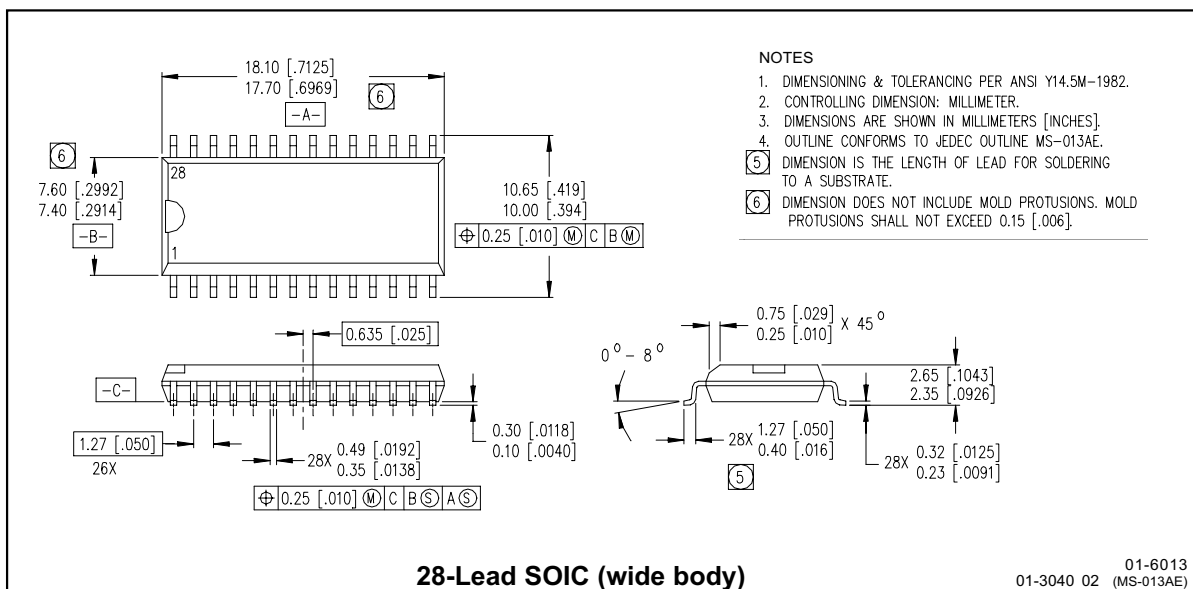
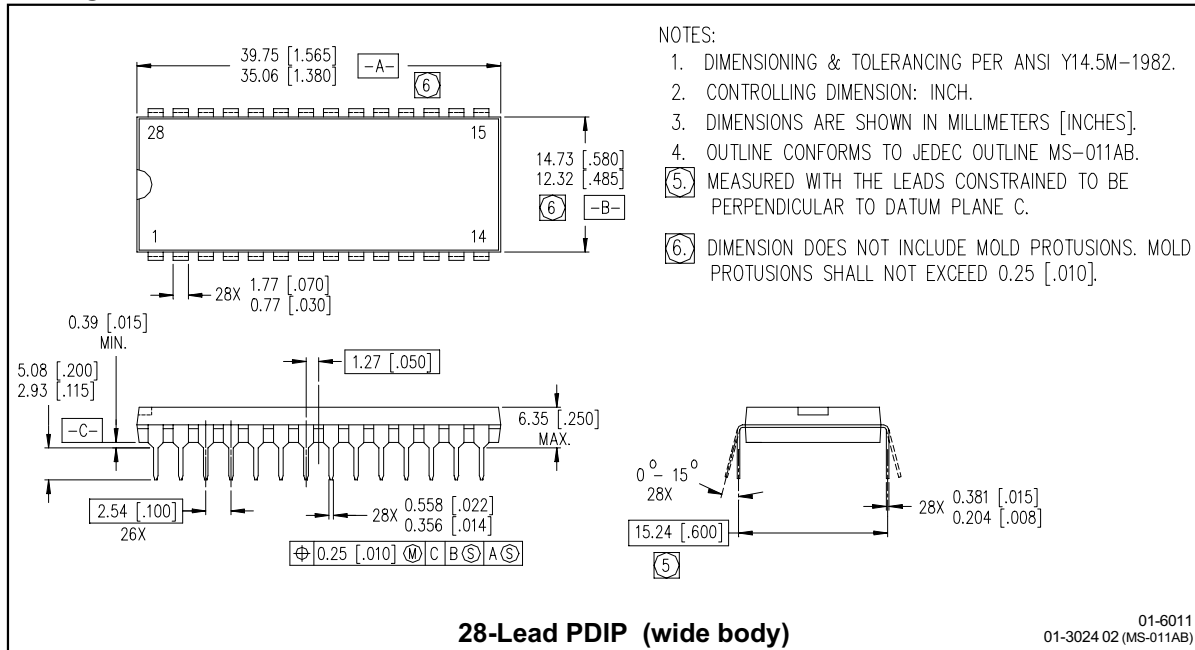

# IR2133/IR2135/IR2233/IR2235(J&S)&(PbF)

International  
**IR** Rectifier



## IR2133/IR2135/IR2233/IR2235(J&S)&(PbF)

### LEADFREE PART MARKING INFORMATION



### ORDER INFORMATION

#### Basic Part (Non-Lead Free)

28-Lead PDIP IR2133 order IR2133 2  
 8-Lead SOIC IR2133S order IR2133S  
 28-Lead PDIP IR2135 order IR2135  
 28-Lead SOIC IR2135S order IR2135S  
 28-Lead PDIP IR2233 not available  
 28-Lead SOIC IR2233S order IR2233S  
 28-Lead PDIP IR2235 not available  
 28-Lead SOIC IR2235S order IR2235S  
 44-Lead PLCC IR2133J order IR2133J  
 44-Lead PLCC IR2135J order IR2135J  
 44-Lead PLCC IR2233J order IR2233J  
 44-Lead PLCC IR2235J order IR2235J

#### Leadfree Part

28-Lead PDIP IR2133 order IR2133PbF  
 28-Lead SOIC IR2133S order IR2133SPbF  
 28-Lead PDIP IR2135 order IR2135PbF  
 28-Lead SOIC IR2135S order IR2135SPbF  
 28-Lead PDIP IR2233 order IR2233PbF  
 28-Lead SOIC IR2233S order IR2233SPbF  
 28-Lead PDIP IR2235 order IR2235PbF  
 28-Lead SOIC IR2235S order IR2235SPbF  
 44-Lead PLCC IR2133J order IR2133JPbF  
 44-Lead PLCC IR2135J order IR2135JPbF  
 44-Lead PLCC IR2233J order IR2233JPbF  
 44-Lead PLCC IR2235J order IR2235JPbF



Компания «ЭлектроПласт» предлагает заключение долгосрочных отношений при поставках импортных электронных компонентов на взаимовыгодных условиях!

Наши преимущества:

- Оперативные поставки широкого спектра электронных компонентов отечественного и импортного производства напрямую от производителей и с крупнейших мировых складов;
- Поставка более 17-ти миллионов наименований электронных компонентов;
- Поставка сложных, дефицитных, либо снятых с производства позиций;
- Оперативные сроки поставки под заказ (от 5 рабочих дней);
- Экспресс доставка в любую точку России;
- Техническая поддержка проекта, помощь в подборе аналогов, поставка прототипов;
- Система менеджмента качества сертифицирована по Международному стандарту ISO 9001;
- Лицензия ФСБ на осуществление работ с использованием сведений, составляющих государственную тайну;
- Поставка специализированных компонентов (Xilinx, Altera, Analog Devices, Intersil, Interpoint, Microsemi, Aeroflex, Peregrine, Syfer, Eurofarad, Texas Instrument, Miteq, Cobham, E2V, MA-COM, Hittite, Mini-Circuits, General Dynamics и др.);

Помимо этого, одним из направлений компании «ЭлектроПласт» является направление «Источники питания». Мы предлагаем Вам помощь Конструкторского отдела:

- Подбор оптимального решения, техническое обоснование при выборе компонента;
- Подбор аналогов;
- Консультации по применению компонента;
- Поставка образцов и прототипов;
- Техническая поддержка проекта;
- Защита от снятия компонента с производства.



#### Как с нами связаться

**Телефон:** 8 (812) 309 58 32 (многоканальный)

**Факс:** 8 (812) 320-02-42

**Электронная почта:** [org@eplast1.ru](mailto:org@eplast1.ru)

**Адрес:** 198099, г. Санкт-Петербург, ул. Калинина, дом 2, корпус 4, литера А.