

FA / FS SERIES

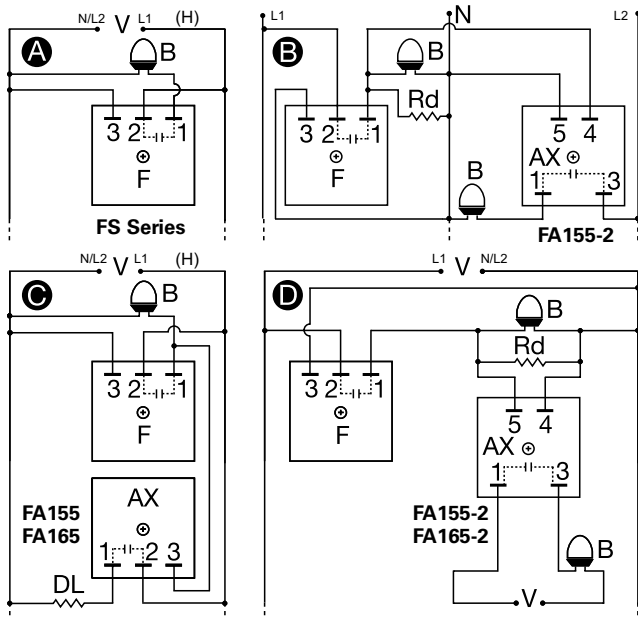

*(FS155 & FA155 models only)

Wiring Diagram



V = Voltage N = Neutral B = Beacon
 DL = Dummy Load for Constant Line Loading
 Rd = 3.3 K Ω @ 5W for 120VAC; 8.5 K Ω @ 5W for 230VAC
 F = Flasher (FS155-30T, FS155-30RF, FS165-30T)
 AX = Auxiliary Unit (FA155, FA155-2, FA165, FA156-2)

Description

The FA/FS Series have proven their reliability through years of use on communication towers, smoke stacks, cooling towers, tall buildings, bridges and utility towers. The highest quality components are encapsulated in a rugged plastic housing with a molded-in heat transfer plate. The flash rate, ratio, and fail-safe design meet FAA regulations. Zero voltage switching can increase lamp life up to ten times. The FS155-30RF includes superior RF filtering circuitry for use in high RF installations, including AM hot towers.

Operation

FS Series - Flasher (OFF First)

FA Series - Auxiliary Modules

Upon application of input voltage, the T2 OFF time begins. At the end of the OFF time, the T1 ON time begins and the load energizes. At the end of T1, T2 begins and the load de-energizes. This cycle repeats until voltage is removed.

Reset: Removing input voltage resets the output and the sequence to T2.

Features & Benefits

FEATURES	BENEFITS
Zero voltage switching	Delivers up to 10 times longer lamp life
Encapsulated	Protects against shock, vibration, and humidity
Metalized mounting surface	Facilitates heat transfer in high current applications
Superior RF filtering circuitry (RF models only)	Ideal for AM hot towers and other high RF installations
High inrush capability up to 200A	Will withstand the repetitive inrush current of incandescent beacons

Ordering Information

MODEL	INPUT VOLTAGE	WATTAGE	INRUSH RATING	DESCRIPTION
FA155	120VAC	2500W	200A	Auxiliary unit to provide constant line loading
FA155-2	120VAC	2500W	200A	Auxiliary unit for synchronized operating of additional beacons. Synchronized flashing of additional beacons on a 3 wire system
FA165	230VAC	5000W	200A	Auxiliary unit to provide constant line loading
FA165-2	230VAC	5000W	200A	Auxiliary unit for synchronized operating of additional beacons. Synchronized flashing of additional beacons on a 2 wire system
FS155-30RF	120VAC	2500W	200A	For high RF interference locations including AM hot towers
FS155-30T	120VAC	2500W	200A	Standard beacon flasher
FS165-30T	230VAC	5000W	200A	Standard beacon flasher

If you don't find the part you need, call us for a custom product 800-843-8848

FA / FS SERIES

Accessories



P1015-13 (AWG 10/12), **P1015-64** (AWG 14/16), **P1015-14** (AWG 18/22) **Female Quick Connect**
 These 0.25 in. (6.35 mm) female terminals are constructed with an insulator barrel to provide strain relief.



P1015-18 Quick Connect to Screw Adapter
 Screw adapter terminal designed for use with all modules with 0.25 in. (6.35 mm) male quick connect terminals.

Flasher Function Diagrams



V = Voltage
 R = Reset
 L = Load
 T1 = ON Time
 T2 = OFF Time
 T1 = T2
 F = Flasher
 DL = Dummy Load
 AX = Auxillary Module

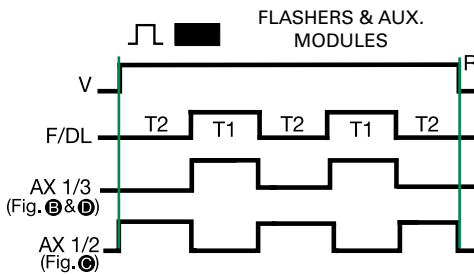

Specifications

Operation

Single & multiple beacon flashing with auxiliary modules

Flash Rate (FS Series Only)

30 ±10 FPM

ON/OFF Ratio

(FS Series Only)

50 - 67% ON time; 33 - 50% OFF time

Voltage

120 or 230VAC ±20%

AC Line Frequency

50/60Hz

Output Rating (Zero Voltage Switching)

2500W @ 120VAC; 5000W @ 230VAC

Inrush Current

200A peak for 1 cycle of AC line

Mounting*

Surface mount with one #10 (M5 x 0.8) screw

Dimensions

H 50.8 mm (2"); **W** 50.8 mm (2");

D 38.4 mm (1.51")

Termination

0.25 in. (6.35 mm) male quick connect terminals

Circuitry

Encapsulated

Operating/Storage Temperature

-55° to 65°C / -55° to 85°C

Humidity

95% relative, non-condensing

Weight

≈ 3.9 oz (111 g)

* Note: Must be mounted to metal surface using the included heat sink compound. The maximum mounting surface temperature is 90°C.



Компания «ЭлектроПласт» предлагает заключение долгосрочных отношений при поставках импортных электронных компонентов на взаимовыгодных условиях!

Наши преимущества:

- Оперативные поставки широкого спектра электронных компонентов отечественного и импортного производства напрямую от производителей и с крупнейших мировых складов;
- Поставка более 17-ти миллионов наименований электронных компонентов;
- Поставка сложных, дефицитных, либо снятых с производства позиций;
- Оперативные сроки поставки под заказ (от 5 рабочих дней);
- Экспресс доставка в любую точку России;
- Техническая поддержка проекта, помощь в подборе аналогов, поставка прототипов;
- Система менеджмента качества сертифицирована по Международному стандарту ISO 9001;
- Лицензия ФСБ на осуществление работ с использованием сведений, составляющих государственную тайну;
- Поставка специализированных компонентов (Xilinx, Altera, Analog Devices, Intersil, Interpoint, Microsemi, Aeroflex, Peregrine, Syfer, Eurofarad, Texas Instrument, Miteq, Cobham, E2V, MA-COM, Hittite, Mini-Circuits, General Dynamics и др.);

Помимо этого, одним из направлений компании «ЭлектроПласт» является направление «Источники питания». Мы предлагаем Вам помощь Конструкторского отдела:

- Подбор оптимального решения, техническое обоснование при выборе компонента;
- Подбор аналогов;
- Консультации по применению компонента;
- Поставка образцов и прототипов;
- Техническая поддержка проекта;
- Защита от снятия компонента с производства.



Как с нами связаться

Телефон: 8 (812) 309 58 32 (многоканальный)

Факс: 8 (812) 320-02-42

Электронная почта: org@eplast1.ru

Адрес: 198099, г. Санкт-Петербург, ул. Калинина, дом 2, корпус 4, литера А.