

Optocoupler, Phototriac Output, Zero Crossing, Very Low Input Current

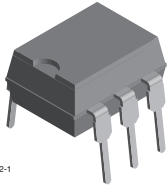

21842-1

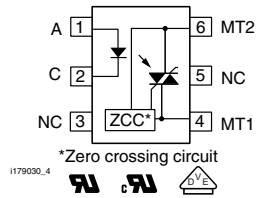

DESCRIPTION

The IL4116, IL4117, and IL4118 consists of an AlGaAs IRLED optically coupled to a photosensitive zero crossing TRIAC network. The TRIAC consists of two inverse parallel connected monolithic SCRs. These three semiconductor devices are assembled in a six pin 300 mil dual in-line package.

High input sensitivity is achieved by using an emitter follower phototransistor and a cascaded SCR predriver resulting in an LED trigger current of less than 1.3 mA (DC).

The IL4116, IL4117, IL4118 uses zero cross line voltage detection circuit witch consists of two enhancement MOSFETs and a photodiode. The inhibit voltage of the network is determined by the enhancement voltage of the n-channel FET. The P-channel FET is enabled by a photocurrent source that permits the FET to conduct the main voltage to gate on the n-channel FET. Once the main voltage can enable the n-channel, it clamps the base of the phototransistor, disabling the first stage SCR predriver.

The blocking voltage of up to 800 V permits control of off-line voltages up to 240 V_{AC}, with a safety factor of more than two, and is sufficient for as much as 380 V_{AC}. Current handling capability is up to 300 mA RMS continuous at 25 °C.

The IL4116, IL4117, IL4118 isolates low-voltage logic from 120 V_{AC}, 240 V_{AC}, and 380 V_{AC} lines to control resistive, inductive, or capacitive loads including motors, solenoids, high current thyristors or TRIAC and relays.

Applications include solid-state relays, industrial controls, office equipment, and consumer appliances.

FEATURES

- High input sensitivity: I_{FT} = 1.3 mA, PF = 1.0; I_{FT} = 3.5 mA, typical PF < 1.0
- Zero voltage crossing
- 600 V, 700 V, and 800 V blocking voltage
- 300 mA on-state current
- High dV/dt 10 000 V/μs
- Isolation test voltage 5300 V_{RMS}
- Very low leakage < 10 μA
- Compliant to RoHS Directive 2002/95/EC and in accordance to WEEE 2002/96/EC

RoHS
COMPLIANT

APPLICATIONS

- Solid state relay
- Lighting controls
- Temperature controls
- Solenoid/valve controls
- AC motor drives/starters

AGENCY APPROVALS

- UL1577, file no. E52744 system code H or J, double protection
- CSA 93751
- BSI IEC60950; IEC60065
- DIN EN 60747-5-5 (VDE 0884) available with option 1
- FIMKO

ORDERING INFORMATION

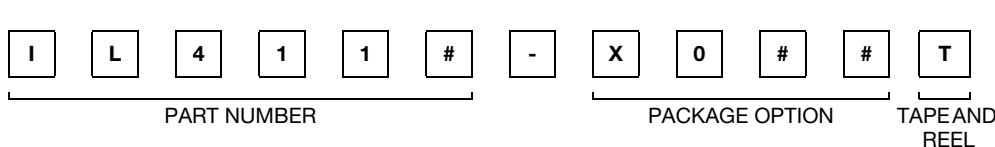

AGENCY CERTIFIED/PACKAGE	BLOCKING VOLTAGE V _{DRM} (V)		
	600	700	800
UL, cUL, BSI, FIMKO			
DIP-6	IL4116	IL4117	IL4118
DIP-6, 400 mil, option 6	IL4116-X006	-	IL4118-X006
SMD-6, option 7	IL4116-X007T ⁽¹⁾	IL4117-X007	IL4118-X007T ⁽¹⁾
SMD-6, option 9	IL4116-X009T ⁽¹⁾	-	IL4118-X009T ⁽¹⁾
VDE, UL, cUL, BSI, FIMKO			
DIP-6	IL4116-X001	IL4117-X001	IL4118-X001
DIP-6, 400 mil, option 6	IL4116-X016	-	IL4118-X016
SMD-6, option 7	-	-	IL4118-X017
SMD-6, option 9	IL4116-X019T ⁽¹⁾	-	-

Note

⁽¹⁾ Also available in tubes, do not put T on the end.

IL4116, IL4117, IL4118



Vishay Semiconductors Optocoupler, Phototriac Output, Zero Crossing, Very Low Input Current

ABSOLUTE MAXIMUM RATINGS ⁽¹⁾ ($T_{amb} = 25\text{ }^{\circ}\text{C}$, unless otherwise specified)					
PARAMETER	TEST CONDITION	PART	SYMBOL	VALUE	UNIT
INPUT					
Reverse voltage			V_R	6	V
Forward current			I_F	60	mA
Surge current			I_{FSM}	2.5	A
Power dissipation			P_{diss}	100	mW
Derate linearly from 25 °C				1.33	mW/°C
Thermal resistance			R_{th}	750	°C/W
OUTPUT					
Peak off-state voltage		IL4116	V_{DRM}	600	V
		IL4117	V_{DRM}	700	V
		IL4118	V_{DRM}	800	V
RMS on-state current			I_{DRM}	300	mA
Single cycle surge				3	A
Power dissipation			P_{diss}	500	mW
Derate linearly from 25 °C				6.6	mW/°C
Thermal resistance			R_{th}	150	°C/W
COUPLER					
Creepage distance				≥ 7	mm
Clearance distance				≥ 7	mm
Storage temperature			T_{stg}	- 55 to + 150	°C
Operating temperature			T_{amb}	- 55 to + 100	°C
Isolation test voltage			V_{ISO}	5300	V_{RMS}
Isolation resistance	$V_{IO} = 500\text{ V}, T_{amb} = 25\text{ }^{\circ}\text{C}$		R_{IO}	$\geq 10^{12}$	Ω
	$V_{IO} = 500\text{ V}, T_{amb} = 100\text{ }^{\circ}\text{C}$		R_{IO}	$\geq 10^{11}$	Ω
Lead soldering temperature ⁽²⁾	5 s		T_{sld}	260	°C

Notes

- ⁽¹⁾ Stresses in excess of the absolute maximum ratings can cause permanent damage to the device. Functional operation of the device is not implied at these or any other conditions in excess of those given in the operational sections of this document. Exposure to absolute maximum ratings for extended periods of the time can adversely affect reliability.
- ⁽²⁾ Refer to reflow profile for soldering conditions for surface mounted devices (SMD). Refer to wave profile for soldering conditions for through hole devices (DIP).



IL4116, IL4117, IL4118

Optocoupler, Phototriac Output, Zero Crossing, Very Low Input Current Vishay Semiconductors

ELECTRICAL CHARACTERISTICS ($T_{amb} = 25\text{ }^{\circ}\text{C}$, unless otherwise specified)							
PARAMETER	TEST CONDITION	PART	SYMBOL	MIN.	TYP.	MAX.	UNIT
INPUT							
Forward voltage	$I_F = 20\text{ mA}$		V_F		1.3	1.5	V
Breakdown voltage	$I_R = 10\text{ }\mu\text{A}$		V_{BR}	6	30		V
Reverse current	$V_R = 6\text{ V}$		I_R		0.1	10	μA
Capacitance	$V_F = 0\text{ V}$, $f = 1\text{ MHz}$		C_O		40		pF
Thermal resistance, junction to lead			R_{thjl}		750		$^{\circ}\text{C/W}$
OUTPUT							
Repetitive peak off-state voltage	$I_{DRM} = 100\text{ }\mu\text{A}$	IL4116	V_{DRM}	600	650		V
		IL4117	V_{DRM}	700	750		V
		IL4118	V_{DRM}	800	850		V
Off-state voltage	$I_{D(RMS)} = 70\text{ }\mu\text{A}$	IL4116	$V_{D(RMS)}$	424	460		V
		IL4117	$V_{D(RMS)}$	494	536		V
		IL4118	$V_{D(RMS)}$	565	613		V
Off-state current	$V_D = 600$, $T_{amb} = 100\text{ }^{\circ}\text{C}$		$I_{D(RMS)}$		10	100	μA
On-state voltage	$I_T = 300\text{ mA}$		V_{TM}		1.7	3	V
On-state current	$PF = 1$, $V_{T(RMS)} = 1.7\text{ V}$		I_{TM}			300	mA
Surge (non-repetitive, on-state current)	$f = 50\text{ Hz}$		I_{TSM}			3	A
Holding current	$V_T = 3\text{ V}$		I_H		65	200	μA
Latching current	$V_T = 2.2\text{ V}$		I_L			500	μA
LED trigger current	$V_{AK} = 5\text{ V}$		I_{FT}		0.7	1.3	mA
Zero cross inhibit voltage	$I_F = \text{rated } I_{FT}$		V_{IH}		15	25	V
Critical rate of rise off-state voltage	V_{RM} , $V_{DM} = 400\text{ VAC}$		dV/dt_{cr}	10 000			$\text{V}/\mu\text{s}$
	V_{RM} , $V_{DM} = 400\text{ VAC}$, $T_{amb} = 80\text{ }^{\circ}\text{C}$		dV/dt_{cr}		2000		$\text{V}/\mu\text{s}$
Critical rate of rise of voltage at current commutation	$V_D = 230\text{ V}_{RMS}$, $I_D = 300\text{ mA}_{RMS}$, $T_J = 25\text{ }^{\circ}\text{C}$		dV/dt_{crq}		8		$\text{V}/\mu\text{s}$
	$V_D = 230\text{ V}_{RMS}$, $I_D = 300\text{ mA}_{RMS}$, $T_J = 85\text{ }^{\circ}\text{C}$		dV/dt_{crq}		7		$\text{V}/\mu\text{s}$
Critical rate of rise of on-state current commutation	$V_D = 230\text{ V}_{RMS}$, $I_D = 300\text{ mA}_{RMS}$, $T_J = 25\text{ }^{\circ}\text{C}$		dV/dt_{crq}		12		A/ms
Thermal resistance, junction to lead			R_{thjl}		150		$^{\circ}\text{C/W}$
COUPLER							
Critical rate of rise of coupler input-output voltage	$I_T = 0\text{ A}$, $V_{RM} = V_{DM} = 424\text{ VAC}$		$dV_{(IO)}/dt$	10 000			$\text{V}/\mu\text{s}$
Capacitance (input to output)	$f = 1\text{ MHz}$, $V_{IO} = 0\text{ V}$		C_{IO}		0.8		pF
Common mode coupling capacitance			C_{CM}		0.01		pF

Note

- Minimum and maximum values are testing requirements. Typical values are characteristics of the device and are the result of engineering evaluation. Typical values are for information only and are not part of the testing requirements.

SWITCHING CHARACTERISTICS							
PARAMETER	TEST CONDITION	PART	SYMBOL	MIN.	TYP.	MAX.	UNIT
Turn-on time	$V_{RM} = V_{DM} = 424\text{ VAC}$		t_{on}		35		μs
Turn-off time	$PF = 1$, $I_T = 300\text{ mA}$		t_{off}		50		μs

TYPICAL CHARACTERISTICS ($T_{amb} = 25\text{ }^{\circ}\text{C}$, unless otherwise specified)

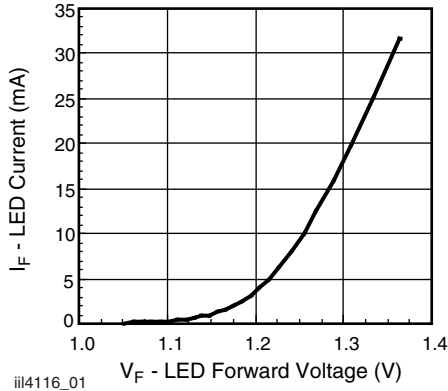

Fig. 1 - LED Forward Current vs. Forward Voltage

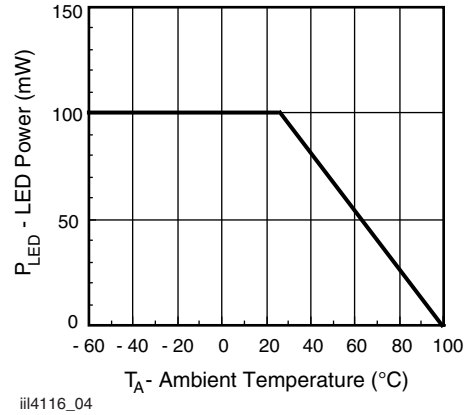

Fig. 4 - Maximum LED Power Dissipation

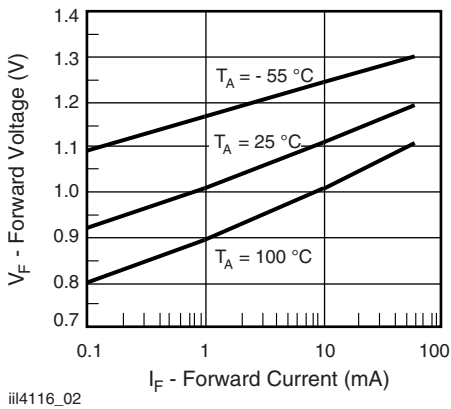

Fig. 2 - Forward Voltage vs. Forward Current

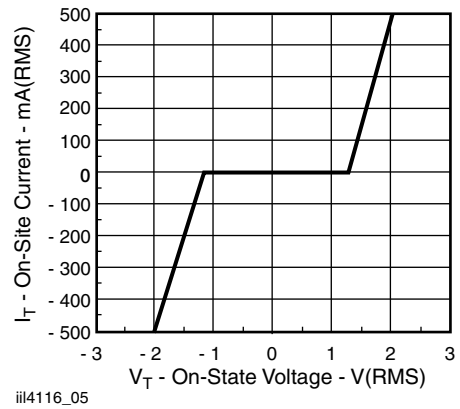

Fig. 5 - On-State Terminal Voltage vs. Terminal Current

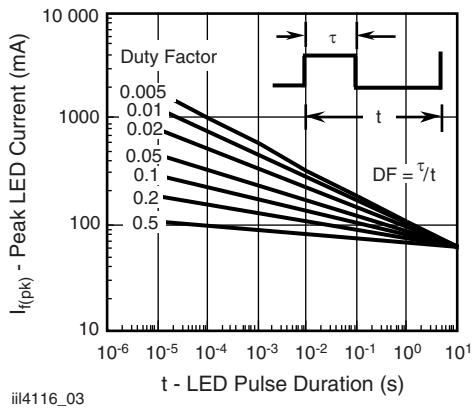

Fig. 3 - Peak LED Current vs. Duty Factor, τ

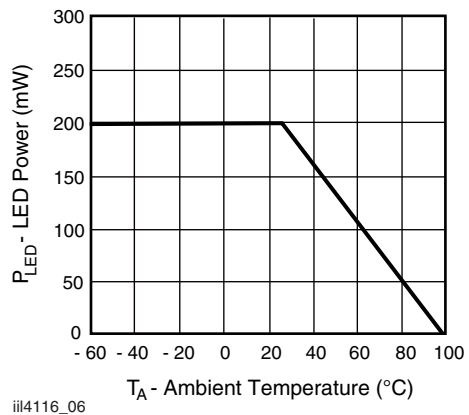

Fig. 6 - Maximum Output Power Dissipation

TRIGGER CURRENT VS. TEMPERATURE AND VOLTAGE

The trigger current of the IL4116, IL4117, IL4118 has a positive temperature gradient and also is dependent on the terminal voltage as shown as the fig. 7.

For the operating voltage 250 V_{RMS} over the temperature range - 40 °C to 85 °C, the I_F should be at least 2.3 x of the I_{FT1} (1.3 mA, max.).

Considering - 30 % degradation over time, the trigger current minimum is I_F = 1.3 x 2.3 x 130 % = 4 mA

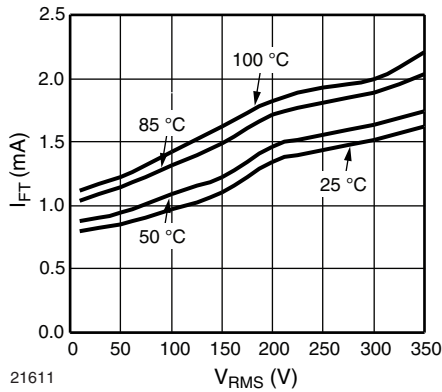

Fig. 7 - Trigger Current vs. Temperature and Operating Voltage (50 Hz)

INDUCTIVE AND RESISTIVE LOADS

For inductive loads, there is phase shift between voltage and current, shown in the fig. 8.

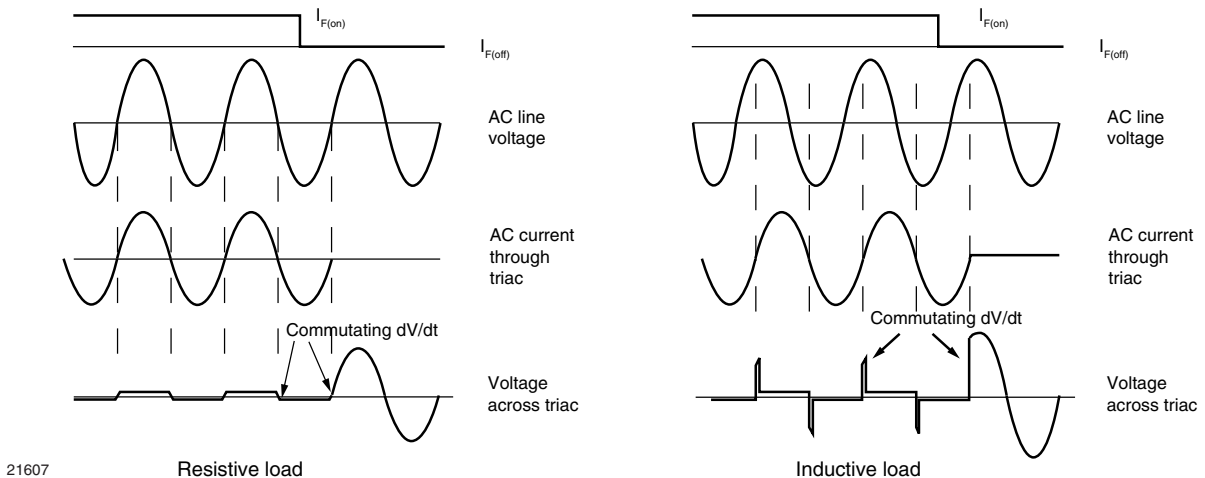

Fig. 8 - Waveforms of Resistive and Inductive Loads

The voltage across the triac will rise rapidly at the time the current through the power handling triac falls below the holding current and the triac ceases to conduct. The rise rate of voltage at the current commutation is called commutating dV/dt. There would be two potential problems for ZC phototriac control if the commutating dV/dt is too high. One is lost control to turn off, another is failed to keep the triac on.

Lost control to turn off

If the commutating dV/dt is too high, more than its critical rate (dV/dt_{crit}), the triac may resume conduction even if the LED drive current I_F is off and control is lost.

In order to achieve control with certain inductive loads of power factors is less than 0.8, the rate of rise in voltage (dV/dt) must be limited by a series RC network placed in parallel with the power handling triac. The RC network is called snubber circuit. Note that the value of the capacitor increases as a function of the load current as shown in fig. 9.

Failed to keep on

As a zero-crossing phototriac, the commutating dV/dt spikes can inhibit one half of the TRIAC from keeping on. If the spike potential exceeds the inhibit voltage of the zero cross detection circuit, even if the LED drive current I_F is on.

Vishay Semiconductors Optocoupler, Phototriac Output, Zero Crossing, Very Low Input Current

This hold-off condition can be eliminated by using a snubber and also by providing a higher level of LED drive current. The higher LED drive provides a larger photocurrent which causes the triac to turn-on before the commutating spike has activated the zero cross detection circuit. Fig. 10 shows the relationship of the LED current for power factors of less than 1.0. The curve shows that if a device requires 1.5 mA for a resistive load, then 1.8 times (2.7 mA) that amount would be required to control an inductive load whose power factor is less than 0.3 without the snubber to dump the spike.

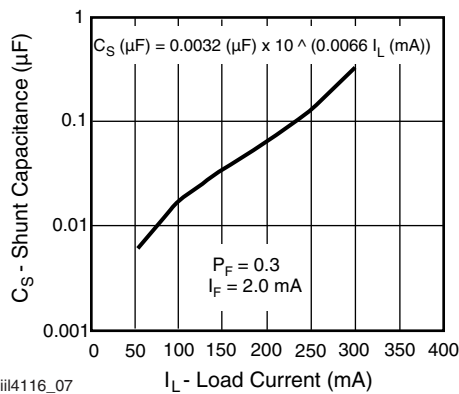

iii4116_07

Fig. 9 - Shunt Capacitance vs. Load Current vs. Power Factor

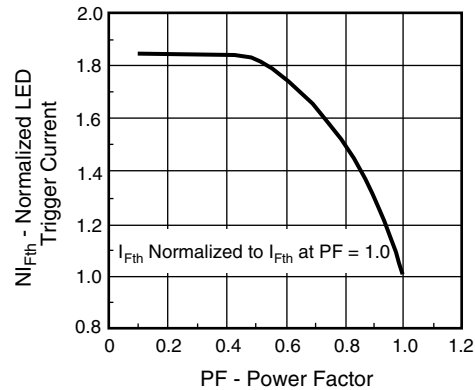

iii4116_08

Fig. 10 - Normalized LED Trigger Current

APPLICATIONS

Direct switching operation:

The IL4116, IL4117, IL4118 isolated switch is mainly suited to control synchronous motors, valves, relays and solenoids. Fig. 11 shows a basic driving circuit. For resistive load the snubber circuit $R_S C_S$ can be omitted due to the high static dV/dt characteristic.

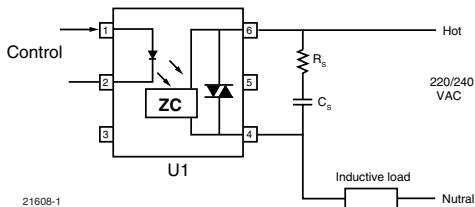

Fig. 11 - Basic Direct Load Driving Circuit

Indirect switching operation:

The IL4116, IL4117, IL4118 switch acts here as an isolated driver and thus enables the driving of power thyristors and power triacs by microprocessors. Fig. 12 shows a basic driving circuit of inductive load. The resistor R_1 limits the driving current pulse which should not exceed the maximum permissible surge current of the IL4116, IL4117, IL4118. The resistor R_G is needed only for very sensitive thyristors or triacs from being triggered by noise or the inhibit current.

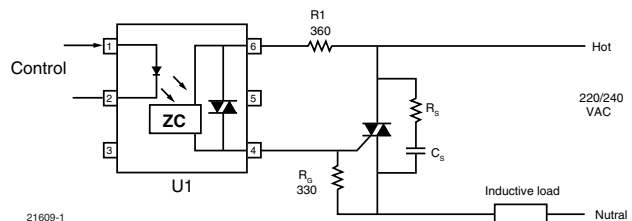

Fig. 12 - Basic Power Triac Driver Circuit



IL4116, IL4117, IL4118

Optocoupler, Phototriac Output, Zero Crossing, Very Low Input Current

PACKAGE DIMENSIONS in millimeters

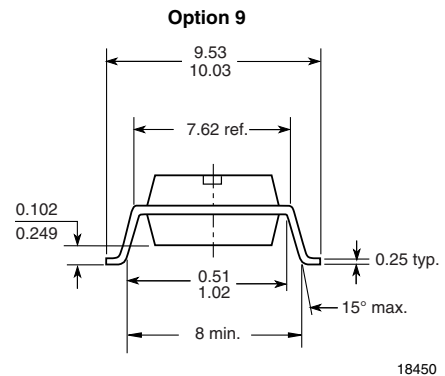
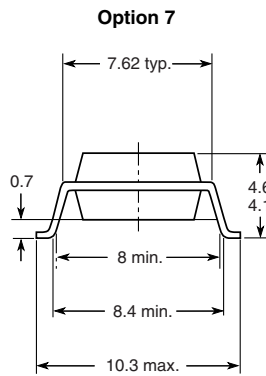
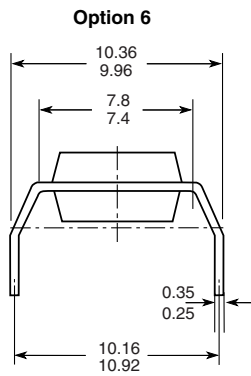
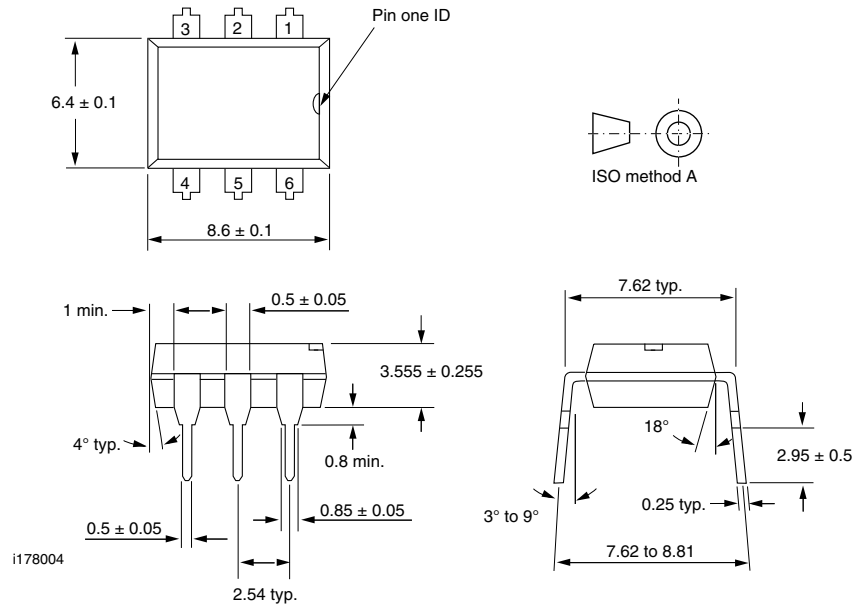



Disclaimer

ALL PRODUCT, PRODUCT SPECIFICATIONS AND DATA ARE SUBJECT TO CHANGE WITHOUT NOTICE TO IMPROVE RELIABILITY, FUNCTION OR DESIGN OR OTHERWISE.

Vishay Intertechnology, Inc., its affiliates, agents, and employees, and all persons acting on its or their behalf (collectively, "Vishay"), disclaim any and all liability for any errors, inaccuracies or incompleteness contained in any datasheet or in any other disclosure relating to any product.

Vishay makes no warranty, representation or guarantee regarding the suitability of the products for any particular purpose or the continuing production of any product. To the maximum extent permitted by applicable law, Vishay disclaims (i) any and all liability arising out of the application or use of any product, (ii) any and all liability, including without limitation special, consequential or incidental damages, and (iii) any and all implied warranties, including warranties of fitness for particular purpose, non-infringement and merchantability.

Statements regarding the suitability of products for certain types of applications are based on Vishay's knowledge of typical requirements that are often placed on Vishay products in generic applications. Such statements are not binding statements about the suitability of products for a particular application. It is the customer's responsibility to validate that a particular product with the properties described in the product specification is suitable for use in a particular application. Parameters provided in datasheets and/or specifications may vary in different applications and performance may vary over time. All operating parameters, including typical parameters, must be validated for each customer application by the customer's technical experts. Product specifications do not expand or otherwise modify Vishay's terms and conditions of purchase, including but not limited to the warranty expressed therein.

Except as expressly indicated in writing, Vishay products are not designed for use in medical, life-saving, or life-sustaining applications or for any other application in which the failure of the Vishay product could result in personal injury or death. Customers using or selling Vishay products not expressly indicated for use in such applications do so at their own risk. Please contact authorized Vishay personnel to obtain written terms and conditions regarding products designed for such applications.

No license, express or implied, by estoppel or otherwise, to any intellectual property rights is granted by this document or by any conduct of Vishay. Product names and markings noted herein may be trademarks of their respective owners.

Material Category Policy

Vishay Intertechnology, Inc. hereby certifies that all its products that are identified as RoHS-Compliant fulfill the definitions and restrictions defined under Directive 2011/65/EU of The European Parliament and of the Council of June 8, 2011 on the restriction of the use of certain hazardous substances in electrical and electronic equipment (EEE) - recast, unless otherwise specified as non-compliant.

Please note that some Vishay documentation may still make reference to RoHS Directive 2002/95/EC. We confirm that all the products identified as being compliant to Directive 2002/95/EC conform to Directive 2011/65/EU.

Vishay Intertechnology, Inc. hereby certifies that all its products that are identified as Halogen-Free follow Halogen-Free requirements as per JEDEC JS709A standards. Please note that some Vishay documentation may still make reference to the IEC 61249-2-21 definition. We confirm that all the products identified as being compliant to IEC 61249-2-21 conform to JEDEC JS709A standards.



Компания «ЭлектроПласт» предлагает заключение долгосрочных отношений при поставках импортных электронных компонентов на взаимовыгодных условиях!

Наши преимущества:

- Оперативные поставки широкого спектра электронных компонентов отечественного и импортного производства напрямую от производителей и с крупнейших мировых складов;
- Поставка более 17-ти миллионов наименований электронных компонентов;
- Поставка сложных, дефицитных, либо снятых с производства позиций;
- Оперативные сроки поставки под заказ (от 5 рабочих дней);
- Экспресс доставка в любую точку России;
- Техническая поддержка проекта, помощь в подборе аналогов, поставка прототипов;
- Система менеджмента качества сертифицирована по Международному стандарту ISO 9001;
- Лицензия ФСБ на осуществление работ с использованием сведений, составляющих государственную тайну;
- Поставка специализированных компонентов (Xilinx, Altera, Analog Devices, Intersil, Interpoint, Microsemi, Aeroflex, Peregrine, Syfer, Eurofarad, Texas Instrument, Miteq, Cobham, E2V, MA-COM, Hittite, Mini-Circuits, General Dynamics и др.);

Помимо этого, одним из направлений компании «ЭлектроПласт» является направление «Источники питания». Мы предлагаем Вам помощь Конструкторского отдела:

- Подбор оптимального решения, техническое обоснование при выборе компонента;
- Подбор аналогов;
- Консультации по применению компонента;
- Поставка образцов и прототипов;
- Техническая поддержка проекта;
- Защита от снятия компонента с производства.



Как с нами связаться

Телефон: 8 (812) 309 58 32 (многоканальный)

Факс: 8 (812) 320-02-42

Электронная почта: org@eplast1.ru

Адрес: 198099, г. Санкт-Петербург, ул. Калинина, дом 2, корпус 4, литера А.