



Non-bendable!

First 6 mm relay with strong mechanical pins

Omron's G2RV:

- Large plug-in pins – Excellent Connection
- LED / Mechanical Flag – Check Operation
- Transparent Housing – Check Condition
- Slim Outline – Space Saving
- Push-in / Accessories – Easy Wiring

www.omron-industrial.com
www.omron-industrial.com/slimrelay

Advanced Industrial Automation

OMRON

Details on the G2RV

Wiring

The G2RV also provides flexibility for wiring. The Bases in this new Relay Series are available with screw terminals or push-in terminals for wire connection.

Choose the best connection method for the application.

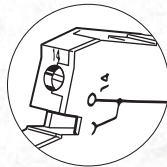
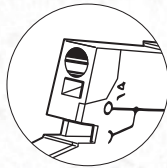

Terminal Block-type Module

With a width of only 6.1 mm, the G2RV meets essentially any FA application, particularly switching and expansion of equipment and machinery. The G2RV is easily installed even under strict space limitations.

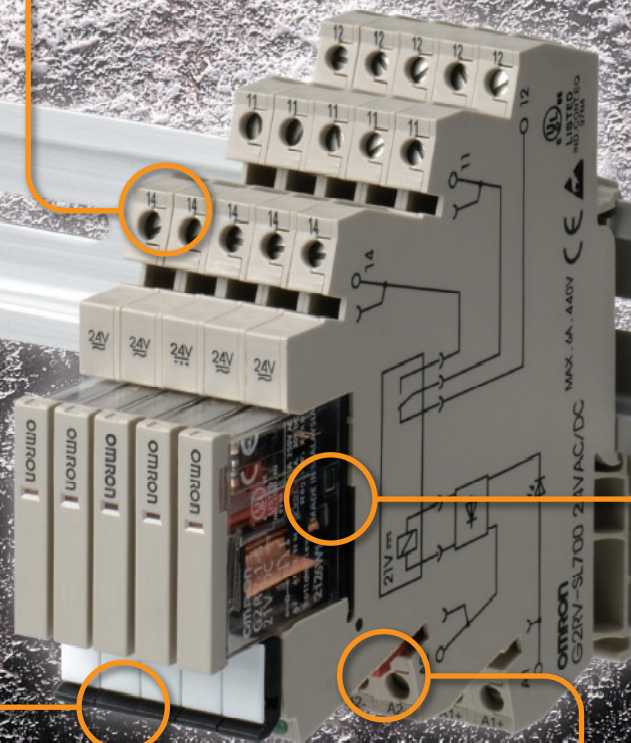

Stoppers and Levers

Easy-to-use stoppers and levers securely hold the Relays to the Base. They also enable easily removing the Relays from the sockets. The stoppers and levers are also equipped with grooves to attach markers, which can be used to easily identify circuits.

Crossbars

P2RV Crossbars come in many variations for the number of poles and edge colors. They can be plugged into any of a total of four slots for I/O according to the application.

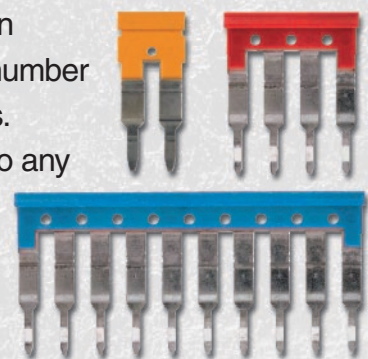

Slim Relay G2RV

The World's First Industrial Slim Relay

- Large plug-in terminals for easy connection.
- LED indicator and mechanical flag to check operation.
- Transparent housing enables checking relay condition.
- Slim outline to save space.
- Push-in terminals and accessories for easy wiring.

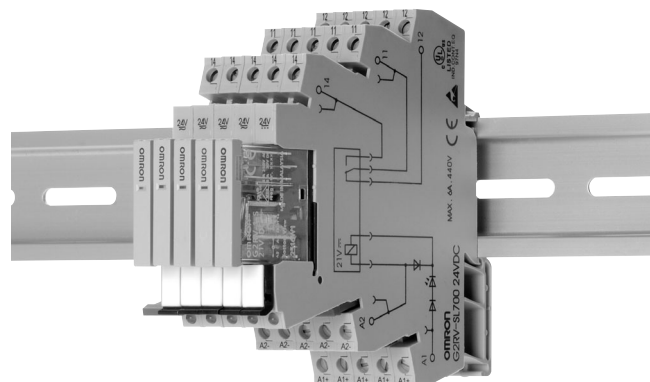

Model Number Structure

Model Number Legend

G2RV-SL -

1 2 3 4 5

1. Auxiliary Type Designation

SL: Slim relay and socket combination

2. Wire Connection

7: Screw terminals

5: Push-in terminals

3. Relay LED

0: Without LED

Note: LED indicator available on Socket.

4. Relay Pushbutton

0: Without pushbutton

5. Input Voltage

Ordering Information

List of Models

| Classification | | Enclosure rating | Input voltage | Type of connection | Contact form |
|-------------------|-----------------|------------------|---------------|--------------------|--------------|
| | | | | | SPDT |
| Plug-in terminals | General-purpose | Unsealed | AC/DC | Screw terminals | G2RV-SL700 |
| | | | | Push-in terminals | G2RV-SL500 |

Relay and Socket Combinations

| Input voltage | Screw terminals | Push-in terminals |
|---------------|----------------------|----------------------|
| 12 VDC | G2RV-SL700-12 VDC | G2RV-SL500-12 VDC |
| 24 VDC | G2RV-SL700-24 VDC | G2RV-SL500-24 VDC |
| 24 VAC/DC | G2RV-SL700-24 VAC/DC | G2RV-SL500-24 VAC/DC |
| 48 VAC/DC | G2RV-SL700-48 VAC/DC | G2RV-SL500-48 VAC/DC |
| 110 VAC | G2RV-SL700-110 VAC | G2RV-SL500-110 VAC |
| 230 VAC | G2RV-SL700-230 VAC | G2RV-SL500-230 VAC |

Specifications

■ Input Ratings

| Rated voltage | Rated current | | | Operate voltage | Release voltage | Power consumption | | Input voltage | |
|---------------|---------------|-------|------|-----------------|-----------------|--------------------|-----------------|---------------|-----------------|
| | AC | | DC | | | % of rated voltage | AC (VA) Approx. | | DC (mW) Approx. |
| | 50 Hz | 60 Hz | | | | | | | |
| 12 VDC | --- | --- | 27.2 | 80% | 10% | --- | 300 mW | ±10% | |
| 24 VDC | --- | --- | 13.3 | | | --- | 300 mW | | |
| 24 VAC/DC | 21.1 | 22.5 | 13.0 | | | 0.5 VA | 300 mW | | |
| 48 VAC/DC | 8.5 | 9.0 | 5.2 | | | 0.4 VA | 250 mW | | |
| 110 VAC | 7.1 | 7.5 | --- | | | 0.8 VA | --- | | |
| 230 VAC | 7.3 | 7.9 | --- | | | 1.7 VA | --- | | |

■ Contact Ratings

| | | |
|--------------------------------|----------------------------------|---|
| Number of poles | 1 pole | |
| Load | Resistive load (cosφ = 1) | Inductive load (cosφ = 0.4, L/R = 7 ms) |
| Rated load | 6 A at 250 VAC; 6 A at 30 VDC | 2.5 A at 250 VAC; 2 A at 30 VDC |
| Rated carry current | 6 A | |
| Max. switching voltage | 440 VAC, 125 VDC | |
| Max. switching current | 6 A | |
| Max. switching power | 1,500 VA 180 W | 500 VA 60 W |
| Failure rate (reference value) | 10 mA at 5 VDC | |

Note: P level: $\lambda_{60} = 0.1 \times 10^{-6}/\text{operation}$

■ Characteristics

| Item | 1 pole |
|--------------------------|--|
| Contact material | AgSnIn |
| Contact resistance | 100 mΩ max. |
| Operate time | 20 ms max., DC input: 5 ms, AC/DC input: 5 ms, AC input: 12 ms (typical values) |
| Release time | 40 ms max., DC input: 8 ms, AC/DC input: 25 ms, AC input: 32 ms (typical values) |
| Max. operating frequency | Mechanical: 18,000 operations/hr Electrical: 1,800 operations/hr (under rated load) |
| Insulation resistance | 1,000 MΩ min. (at 500 VDC) |
| Dielectric strength | 4,000 VAC, 50/60 Hz for 1 min between coil and contacts; 1,000 VAC, 50/60 Hz for 1 min between contacts of same polarity |
| Vibration resistance | Destruction: 10 to 55 to 10 Hz, 0.50 mm single amplitude (1.0 mm double amplitude) Malfunction: 10 to 55 to 10 Hz, 0.50 mm single amplitude (1.0 mm double amplitude) |
| Shock resistance | Destruction: 1,000 m/s ² Malfunction: 200 m/s ² when energized; 100 m/s ² when not energized |
| Endurance | Mechanical: 5,000,000 operations min. Electrical: 70,000 operations min. with NO contact, 50,000 operations min. with NC contact |
| Ambient temperature | Operating: -40°C to 55°C (with no icing or condensation) |
| Ambient humidity | Operating: 5% to 85% |
| Weight | Approx. 35 g |
| Overvoltage category | III |
| Pollution degree | 2 |

Note: Values in the above table are the initial values.

■ Approved Standard

UL 508 (File No. E41643)

| Contact form | Coil ratings | Contact ratings | Operations |
|--------------|-------------------------------|---|------------|
| SPDT | 12 to 48 VDC 24 to 230 VAC | 250 VAC 6 A (Res.) 30 VDC 6 A (Res.) 400 VAC 2 A (Res.) | 6,000 |

IEC/VDE (EN 61810)

| Contact form | Coil ratings | Contact ratings | Operations |
|-------------------|---|---|---------------------------|
| 1 pole changeover | 12, 24 VDC 24, 48 VAC/DC 110, 230 VAC | 250 VAC 6 A (Res.) 30 VDC 6 A (Res.) 400 VAC 2 A (Res.) | 50,000 50,000 6,000 |

Accessories

■ PLC Interfaces

List of Models

| Model number | Description | Connection |
|--------------|----------------|------------|
| P2RV-8-O-F | For output use | Flat cable |

Specifications

| | | |
|-----------------|----------------------|---|
| Input | Rated voltage | 30 VAC/VDC max. |
| | Current capacity | 0.5 A per channel 2.0 A total current, power supply terminal |
| Characteristics | Ambient temperature | Operating: 0 to 55°C Storage: -20 to 85°C |
| | Overvoltage category | III |
| | Pollution degree | 2 |

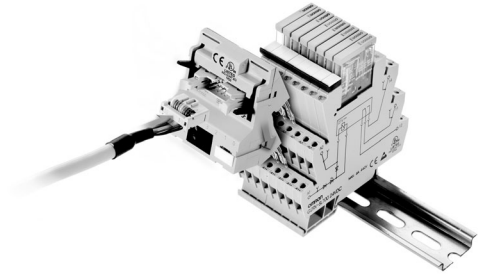

■ DeviceNet

List of Models

| I/O type | Internal I/O common | Number of I/O points | I/O connections | Internal circuit power | Rated I/O power supply voltage | Model |
|----------|---------------------|----------------------|-----------------|---|--------------------------------|---------------|
| Inputs | NPN (+ common) | 16 | MIL connector | Supplied from communications connector. | 24 VDC | DRT2-ID16ML |
| | PNP (- common) | | | | | DRT2-ID16ML-1 |
| Outputs | NPN (- common) | 16 | MIL connector | Supplied from communications connector. | 24 VDC | DRT2-OD16ML |
| | PNP (+ common) | | | | | DRT2-OD16ML-1 |



Specifications

Models with 16-input/16-output Connector Models with 16-input Connector

| Item | DRT2-ID16ML DRT2-ID16MLX | DRT2-ID16ML-1 DRT2-ID16MLX-1 |
|--|--|--|
| Internal I/O common | NPN | PNP |
| I/O points | 16 inputs | |
| ON voltage | 17 VDC min. (between each input terminal and V terminal) | 17 VDC min. (between each input terminal and G terminal) |
| OFF voltage | 5 VDC max. (between each input terminal and V terminal) | 5 VDC max. (between each input terminal and G terminal) |
| OFF current | 1.0 mA max. | |
| Input current | 6.0 mA max./point (at 24 VDC) 3.0 mA max./point (at 17 VDC) | |
| ON delay time | 1.5 ms max. | |
| OFF delay time | 1.5 ms max. | |
| Maximum number of simultaneously ON inputs | 16 | |
| Circuits per common | 16/common | |

Models with 16-input/16-output Connector Models with 16-output Connector

| Item | DRT2-OD16ML DRT2-OD16MLX | DRT2-OD16ML-1 DRT2-OD16MLX-1 |
|----------------------|---|---|
| Internal I/O common | NPN | PNP |
| I/O points | 16 outputs | |
| Rated output current | 0.3 A/point, 2 A/ common (See note 1.) | |
| Residual voltage | 1.2 V max. (0.3 A DC between each output terminal and G terminal) | 1.2 V max. (0.3 A DC between each output terminal and V terminal) |
| Leakage current | 0.1 mA max. | |
| ON delay time | 0.5 ms max. | |
| OFF delay time | 1.5 ms max. | |
| Circuits per common | 16/common | |

Note: Do not allow the total external load current to exceed 2 A.
Do not allow the current for the V terminal or G terminal to exceed 1 A.

■ Single Relays for Maintenance

Model Number Legend

G2RV-□ - □ □ □ - □ - □
 1 2 3 4 5 6

1. Number of Poles

1: 1 pole

2. Terminals

S: Plug-In

3. Relay LED

Blank: Without LED

4. Relay Pushbutton

Blank: Without pushbutton

5. Contact Material

Blank: AgSnIn

6. Rated Coil Voltage

11 VDC, 21 VDC, and 48 VDC

List of Models

| Model number | Replacement for |
|---------------|------------------------|
| G2RV-1-S DC11 | G2RV-SL7□□/5□□ DC12 |
| G2RV-1-S DC21 | G2RV-SL7□□/5□□ DC24 |
| | G2RV-SL7□□/5□□ AC/DC24 |
| G2RV-1-S DC48 | G2RV-SL7□□/5□□ AC/DC48 |
| | G2RV-SL7□□/5□□ AC110 |
| | G2RV-SL7□□/5□□ AC230 |

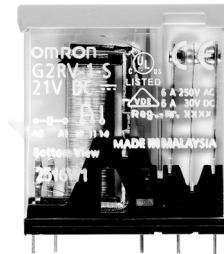

■ Crossbars

Model Number Legend

P2RVM - □ □
 1 2

1. Number of Poles

020: 2 poles

030: 3 poles

040: 4 poles

100: 10 poles

200: 20 poles

2. Color

R: Red

S: Blue

B: Black

| Model number | Poles | Color |
|--------------|-------|-----------|
| P2RVM-020□ | 2 | Red (R) |
| P2RVM-030□ | 3 | Blue (S) |
| P2RVM-040□ | 4 | Black (B) |
| P2RVM-100□ | 10 | |
| P2RVM-200□ | 20 | |

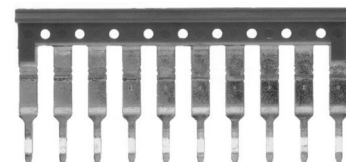
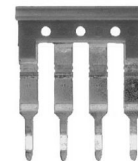

■ Plastic Labels for G2RV Sockets

| Model number | Quantity | Color |
|-----------------|---|-------|
| R99-15 for G2RV | 5 sheets × 120 labels = 600 labels (minimum order) | White |

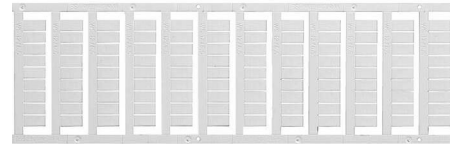

■ Labels (Stickers) for G2RV Sockets

| Model number | Quantity | Color |
|-----------------|--|-------|
| R99-16 for G2RV | 10 sheets × 484 labels = 4,840 labels (minimum order) | White |

■ Separating Plates

| Model number | Quantity | Description |
|--------------|------------------------------|--|
| P2RV-S | 50 plates (minimum order) | Provides isolation between adjacent relays to achieve 440-V isolation. |

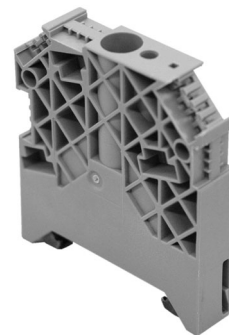

Connections

■ PLC Interfaces

P2RVC-8-O-F

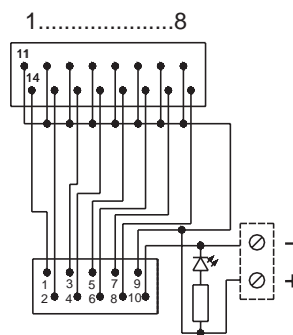
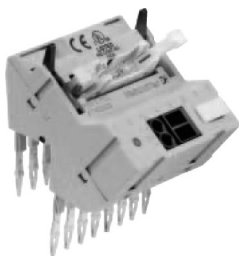

Dimensions

Note: All units are in millimeters unless otherwise indicated.

Complete Unit

G2RV-SL700

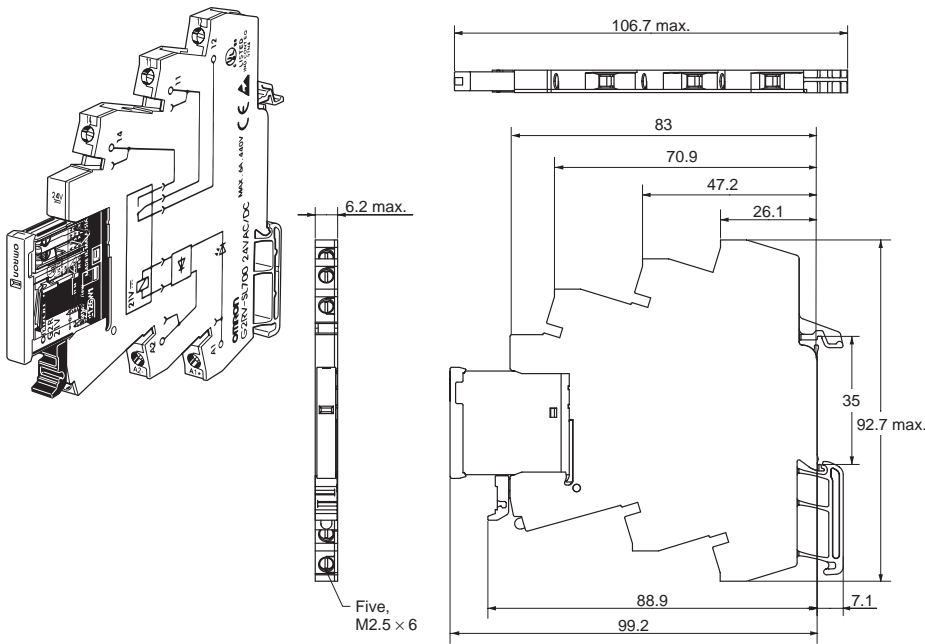

Input circuit

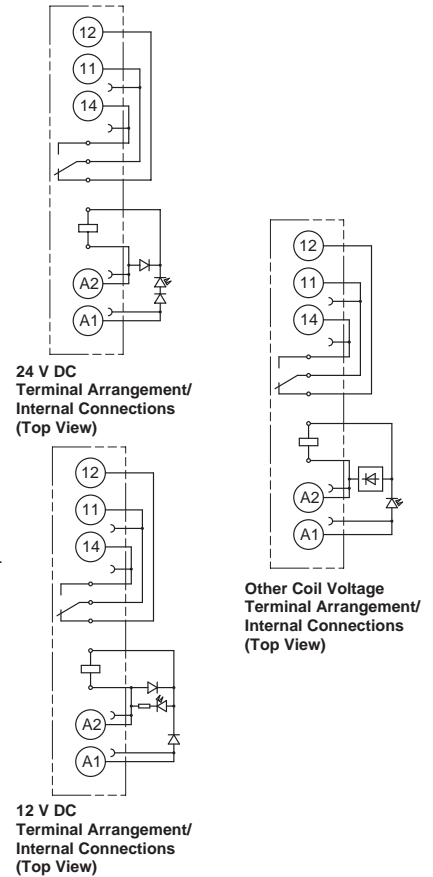

G2RV-SL500

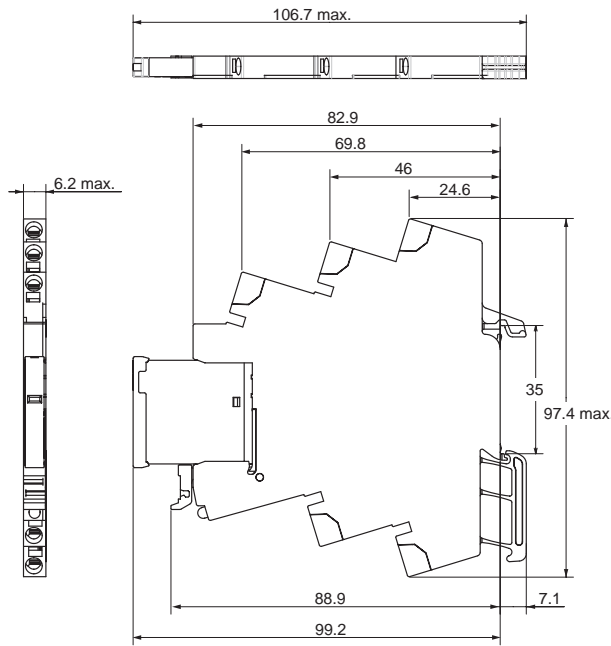
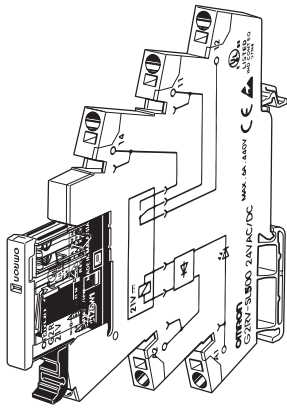

Input circuit

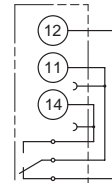

**24 V DC
Terminal Arrangement/
Internal Connections
(Top View)**



**Other Coil Voltage
Terminal Arrangement/
Internal Connections
(Top View)**

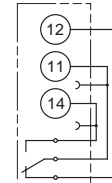

**12 V DC
Terminal Arrangement/
Internal Connections**

Single Relay

G2RV-1-S

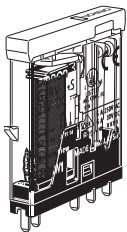

Input circuit

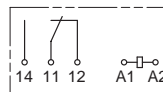

**Terminal Arrangement/
Internal Connections
(Bottom View)**

Installation

■ Tools

A flat-blade screwdriver should be used to mount the cables for G2RV-SL-500-series Relays when using standard wire without ferrules.

Applicable Screwdriver

- Flat-blade, Parallel-tip, 2.5 mm diameter (3.0 mm max.)

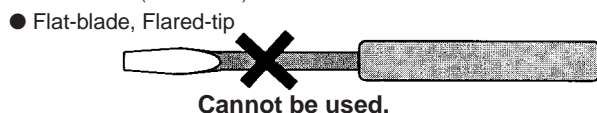
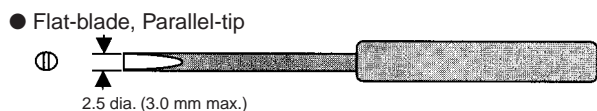

Examples: FACOM AEF.2.5×75E (AEF. 3×75E)
 VESSEL No. 9900-(-)2.5×75 (No. 9900-(-)3×100)
 WIHA 260/2.5×40 (260/3×50)
 WEIDMULLER SD 0.4×2.5×7.5 (SD 0.5×3.0×80)

*Chamfering the tip of the driver improves insertion when used as an exclusive tool.

■ Applicable Wires

Applicable Wire Sizes

G2RV-SL700 Series

| Property | Requirements |
|---|--|
| Cross-section with clamping yoke technology | 0.5 to 2.5 mm ² : stranded/solid (without ferrules) 0.5 to 2.5 mm ² : stranded wires with ferrules with plastic collar 0.5 to 2.5 mm ² : stranded wires with ferrules without plastic collar 4 mm ² : Solid Stripping length: 7 mm |

G2RV-SL500 Series

| Property | Requirements |
|---------------------------------------|---|
| Cross-section with push-in technology | 0.5 to 2.5 mm ² : stranded/solid (without ferrules) 0.5 to 1.5 mm ² : stranded wires with ferrules with plastic collar 0.5 to 2.5 mm ² : stranded wires with ferrules without plastic collar 4 mm ² : Solid Stripping length: 12 mm |

Use wires of the applicable sizes specified in the above table. The length of the exposed conductor should be 7 mm for a G2RV-SL700 series Relay, 12 mm for a G2RV-SL500 series Relay.

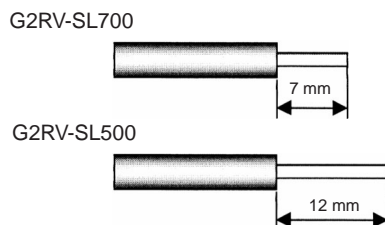
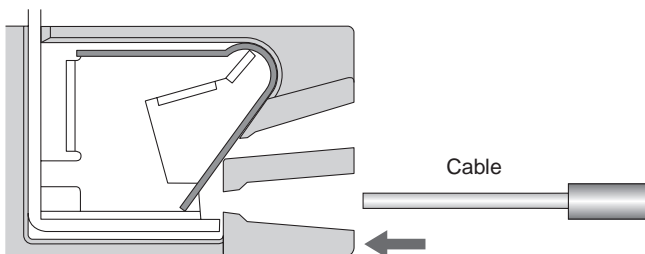

Fig. 1 Exposed Conductor Length

■ Wiring Procedure for G2RV-SL500 Series



● Wiring (for Stranded Wires with Ferrules or Solid Wire)



Insert the exposed conductor into the connection hole.



No other tools are required.

Use the above procedure for stranded wires without ferrules, but add the following step to the beginning of the procedure.



● Remove

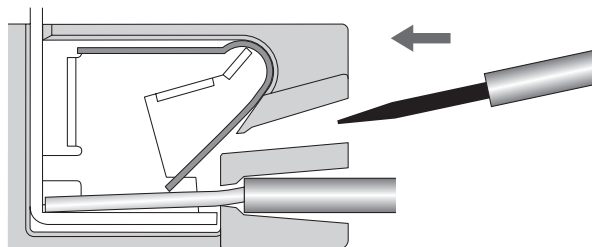

Insert the specified screwdriver into the release hole.

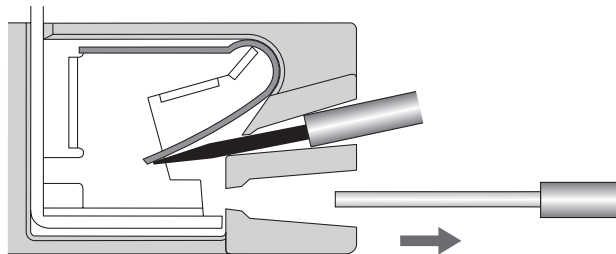

Remove wire.

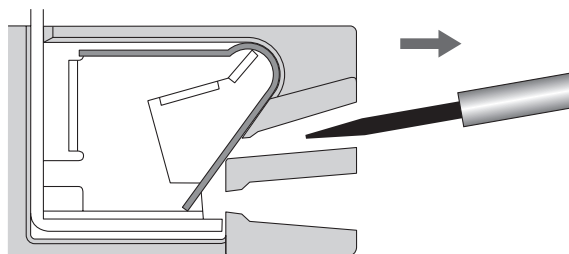

Remove screwdriver.

Note: Remove the screwdriver all the way.

Precautions

Precautions for Connection

- Do not move the screwdriver up, down, or from side to side while it is inserted in the hole. Doing so may cause damage to internal components (e.g., deformation of the clamp spring or cracks in the housing) or cause deterioration of insulation.
- Do not insert the screwdriver at an angle. Doing so may break the side of socket and result in a short-circuit.

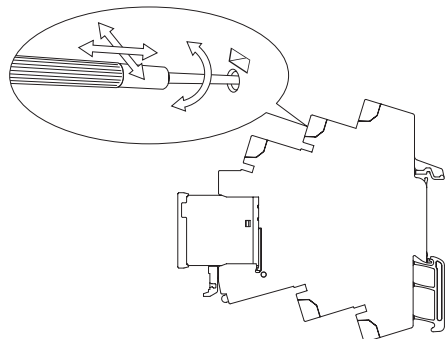

- Do not insert two or more wires in the hole. Wires may come in contact with the spring causing a temperature rise or be subject to sparks.



- Insert the screwdriver along the hole wall as shown below.

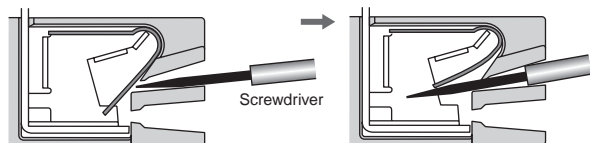

- If lubricating liquid, such as oil, is present on the tip of screwdriver, the screwdriver may fall out resulting in injury to the operator.
- Insert the screwdriver into the bottom of the hole. It may not be possible to connect cables properly if the screwdriver is inserted incorrectly.

General Precautions

- Do not use the product if it has been dropped on the ground. Dropping the product may adversely affect performance.
- Confirm that the socket is securely attached to the mounting track before wiring. If the socket is mounted insecurely it may fall and injure the operator.
- Ensure that the socket is not charged during wiring and maintenance. Not doing so may result in electric shock.
- Do not pour water or cleansing agents on the product. Doing so may result in electric shock.
- Do not use the socket in locations subject to solvents or alkaline chemicals.
- Do not use the socket in locations subject to ultraviolet light (e.g., direct sunlight). Doing so may result in markings fading, rust, corrosion, or resin deterioration.
- Do not dispose of the product in fire.

Removing from Mounting Rail

To remove the socket from the mounting rail, insert the tip of screwdriver in the fixture rail, and move it in the direction shown below.

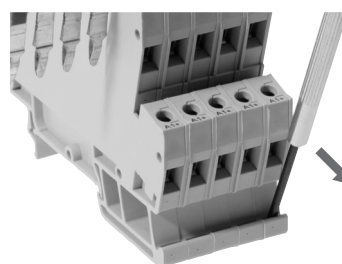

ALL DIMENSIONS SHOWN ARE IN MILLIMETERS.

To convert millimeters into inches, multiply by 0.03937. To convert grams into ounces, multiply by 0.03527.

Cat. No. J163-E1-01 **In the interest of product improvement, specifications are subject to change without notice.**

OMRON RELAY & DEVICES Corporation

Power Relay Division

Marketing Department

1110, Sugi, Yamaga-city, Kumamoto-Pref., 861-0596 Japan

Tel: (81)968-44-4149/Fax: (81)968-44-4107



Компания «ЭлектроПласт» предлагает заключение долгосрочных отношений при поставках импортных электронных компонентов на взаимовыгодных условиях!

Наши преимущества:

- Оперативные поставки широкого спектра электронных компонентов отечественного и импортного производства напрямую от производителей и с крупнейших мировых складов;
- Поставка более 17-ти миллионов наименований электронных компонентов;
- Поставка сложных, дефицитных, либо снятых с производства позиций;
- Оперативные сроки поставки под заказ (от 5 рабочих дней);
- Экспресс доставка в любую точку России;
- Техническая поддержка проекта, помощь в подборе аналогов, поставка прототипов;
- Система менеджмента качества сертифицирована по Международному стандарту ISO 9001;
- Лицензия ФСБ на осуществление работ с использованием сведений, составляющих государственную тайну;
- Поставка специализированных компонентов (Xilinx, Altera, Analog Devices, Intersil, Interpoint, Microsemi, Aeroflex, Peregrine, Syfer, Eurofarad, Texas Instrument, Miteq, Cobham, E2V, MA-COM, Hittite, Mini-Circuits, General Dynamics и др.);

Помимо этого, одним из направлений компании «ЭлектроПласт» является направление «Источники питания». Мы предлагаем Вам помощь Конструкторского отдела:

- Подбор оптимального решения, техническое обоснование при выборе компонента;
- Подбор аналогов;
- Консультации по применению компонента;
- Поставка образцов и прототипов;
- Техническая поддержка проекта;
- Защита от снятия компонента с производства.



Как с нами связаться

Телефон: 8 (812) 309 58 32 (многоканальный)

Факс: 8 (812) 320-02-42

Электронная почта: org@eplast1.ru

Адрес: 198099, г. Санкт-Петербург, ул. Калинина, дом 2, корпус 4, литера А.